

EFM[®]32

... the world's most energy friendly microcontrollers

EFM32ZG108 DATASHEET

F32/F16/F8/F4

Preliminary

- **ARM Cortex-M0+ CPU platform**
 - High Performance 32-bit processor @ up to 24 MHz
 - Wake-up Interrupt Controller
- **Flexible Energy Management System**
 - 20 nA @ 3 V Shutoff Mode
 - 0.5 μ A @ 3 V Stop Mode, including Power-on Reset, Brown-out Detector, RAM and CPU retention
 - 0.9 μ A @ 3 V Deep Sleep Mode, including RTC with 32.768 kHz oscillator, Power-on Reset, Brown-out Detector, RAM and CPU retention
 - 46 μ A/MHz @ 3 V Sleep Mode
 - 114 μ A/MHz @ 3 V Run Mode, with code executed from flash
- **32/16/8/4 KB Flash**
- **4/4/2/2 KB RAM**
- **17 General Purpose I/O pins**
 - Configurable push-pull, open-drain, pull-up/down, input filter, drive strength
 - Configurable peripheral I/O locations
 - 11 asynchronous external interrupts
 - Output state retention and wake-up from Shutoff Mode
- **4 Channel DMA Controller**
- **4 Channel Peripheral Reflex System (PRS) for autonomous inter-peripheral signaling**
- **Timers/Counters**
 - 2x 16-bit Timer/Counter
 - 2x3 Compare/Capture/PWM channels
 - 1x 24-bit Real-Time Counter
 - 1x 16-bit Pulse Counter
 - Watchdog Timer with dedicated RC oscillator @ 50 nA
- **Communication interfaces**
 - 1x Universal Synchronous/Asynchronous Receiver/Transmitter
 - UART/SPI/SmartCard (ISO 7816)/IrDA/I2S
 - Triple buffered full/half-duplex operation
 - Low Energy UART
 - Autonomous operation with DMA in Deep Sleep Mode
 - I²C Interface with SMBus support
 - Address recognition in Stop Mode
- **Ultra low power precision analog peripherals**
 - 1x Analog Comparator
 - Capacitive sensing with up to 2 inputs
 - Supply Voltage Comparator
- **Ultra efficient Power-on Reset and Brown-Out Detector**
- **2-pin Serial Wire Debug interface**
- **Pre-Programmed UART Bootloader**
- **Temperature range -40 to 85 °C**
- **Single power supply 1.85 to 3.8 V**
- **QFN24 package**

32-bit ARM Cortex-M0+, Cortex-M3 and Cortex-M4 microcontrollers for:

- Energy, gas, water and smart metering
- Health and fitness applications
- Smart accessories
- Alarm and security systems
- Industrial and home automation
- www.silabs.com



1 Ordering Information

Table 1.1 (p. 2) shows the available EFM32ZG108 devices.

Table 1.1. Ordering Information

| Ordering Code | Flash (kB) | RAM (kB) | Max Speed (MHz) | Supply Voltage (V) | Temperature (°C) | Package |
|---------------------|------------|----------|-----------------|--------------------|------------------|---------|
| EFM32ZG108F4-QFN24 | 4 | 2 | 24 | 1.85 - 3.8 | -40 - 85 | QFN24 |
| EFM32ZG108F8-QFN24 | 8 | 2 | 24 | 1.85 - 3.8 | -40 - 85 | QFN24 |
| EFM32ZG108F16-QFN24 | 16 | 4 | 24 | 1.85 - 3.8 | -40 - 85 | QFN24 |
| EFM32ZG108F32-QFN24 | 32 | 4 | 24 | 1.85 - 3.8 | -40 - 85 | QFN24 |

Visit www.silabs.com for information on global distributors and representatives.

2 System Summary

2.1 System Introduction

The EFM32 MCUs are the world's most energy friendly microcontrollers. With a unique combination of the powerful 32-bit ARM Cortex-M0+, innovative low energy techniques, short wake-up time from energy saving modes, and a wide selection of peripherals, the EFM32ZG microcontroller is well suited for any battery operated application as well as other systems requiring high performance and low-energy consumption. This section gives a short introduction to each of the modules in general terms and also shows a summary of the configuration for the EFM32ZG108 devices. For a complete feature set and in-depth information on the modules, the reader is referred to the *EFM32ZG Reference Manual*.

A block diagram of the EFM32ZG108 is shown in Figure 2.1 (p. 3) .

Figure 2.1. Block Diagram

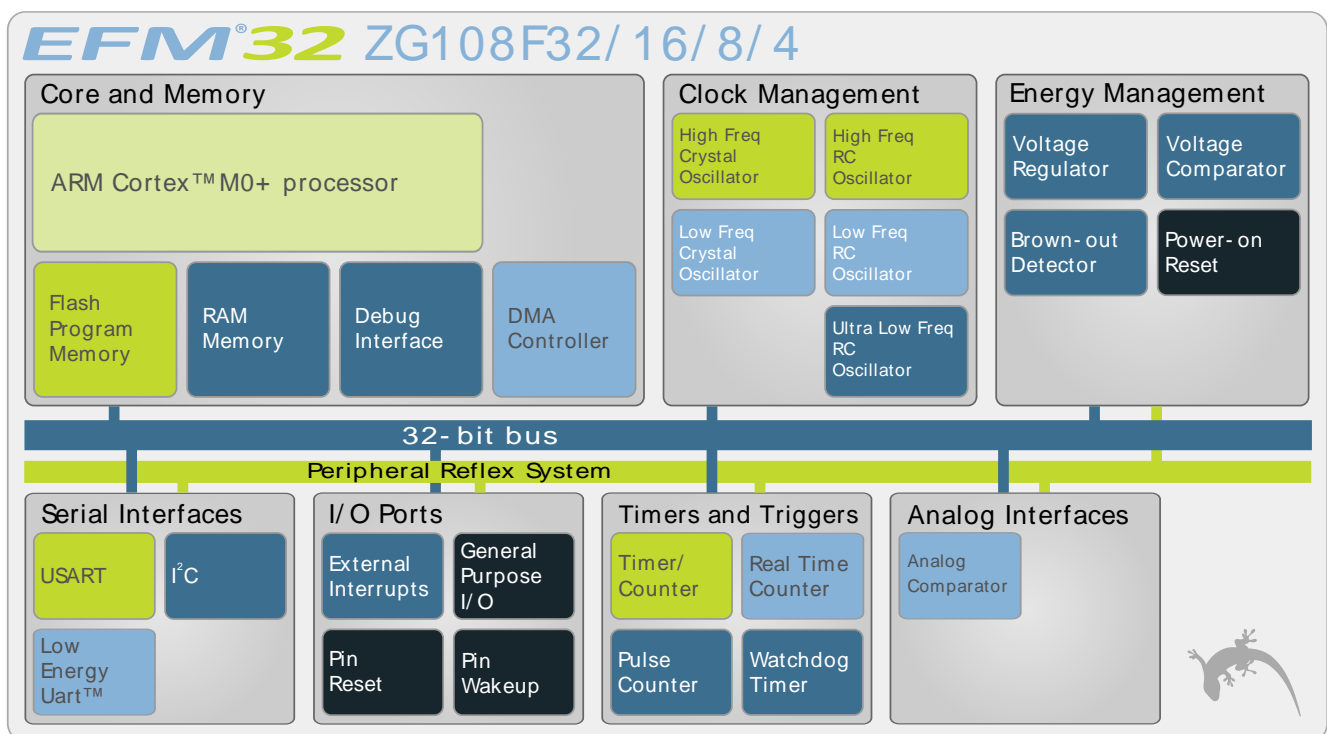

2.1.1 ARM Cortex-M0+ Core

The ARM Cortex-M0+ includes a 32-bit RISC processor which can achieve as much as 0.9 Dhrystone MIPS/MHz. A Wake-up Interrupt Controller handling interrupts triggered while the CPU is asleep is included as well. The EFM32 implementation of the Cortex-M0+ is described in detail in *ARM Cortex-M0+ Devices Generic User Guide*.

2.1.2 Debug Interface (DBG)

This device includes hardware debug support through a 2-pin serial-wire debug interface.

2.1.3 Memory System Controller (MSC)

The Memory System Controller (MSC) is the program memory unit of the EFM32ZG microcontroller. The flash memory is readable and writable from both the Cortex-M0+ and DMA. The flash memory is divided into two blocks; the main block and the information block. Program code is normally written to the main block. Additionally, the information block is available for special user data and flash lock bits. There is also a read-only page in the information block containing system and device calibration data. Read and write operations are supported in the energy modes EM0 and EM1.

2.1.4 Direct Memory Access Controller (DMA)

The Direct Memory Access (DMA) controller performs memory operations independently of the CPU. This has the benefit of reducing the energy consumption and the workload of the CPU, and enables the system to stay in low energy modes when moving for instance data from the USART to RAM or from the External Bus Interface to a PWM-generating timer. The DMA controller uses the PL230 μ DMA controller licensed from ARM.

2.1.5 Reset Management Unit (RMU)

The RMU is responsible for handling the reset functionality of the EFM32ZG.

2.1.6 Energy Management Unit (EMU)

The Energy Management Unit (EMU) manage all the low energy modes (EM) in EFM32ZG microcontrollers. Each energy mode manages if the CPU and the various peripherals are available. The EMU can also be used to turn off the power to unused SRAM blocks.

2.1.7 Clock Management Unit (CMU)

The Clock Management Unit (CMU) is responsible for controlling the oscillators and clocks on-board the EFM32ZG. The CMU provides the capability to turn on and off the clock on an individual basis to all peripheral modules in addition to enable/disable and configure the available oscillators. The high degree of flexibility enables software to minimize energy consumption in any specific application by not wasting power on peripherals and oscillators that are inactive.

2.1.8 Watchdog (WDOG)

The purpose of the watchdog timer is to generate a reset in case of a system failure, to increase application reliability. The failure may e.g. be caused by an external event, such as an ESD pulse, or by a software failure.

2.1.9 Peripheral Reflex System (PRS)

The Peripheral Reflex System (PRS) system is a network which lets the different peripheral module communicate directly with each other without involving the CPU. Peripheral modules which send out Reflex signals are called producers. The PRS routes these reflex signals to consumer peripherals which apply actions depending on the data received. The format for the Reflex signals is not given, but edge triggers and other functionality can be applied by the PRS.

2.1.10 Inter-Integrated Circuit Interface (I2C)

The I²C module provides an interface between the MCU and a serial I²C-bus. It is capable of acting as both a master and a slave, and supports multi-master buses. Both standard-mode, fast-mode and fast-mode plus speeds are supported, allowing transmission rates all the way from 10 kbit/s up to 1 Mbit/s. Slave arbitration and timeouts are also provided to allow implementation of an SMBus compliant system. The interface provided to software by the I²C module, allows both fine-grained control of the transmission process and close to automatic transfers. Automatic recognition of slave addresses is provided in all energy modes.

2.1.11 Universal Synchronous/Asynchronous Receiver/Transmitter (USART)

The Universal Synchronous Asynchronous serial Receiver and Transmitter (USART) is a very flexible serial I/O module. It supports full duplex asynchronous UART communication as well as RS-485, SPI, MicroWire and 3-wire. It can also interface with ISO7816 SmartCards, IrDA and I2S devices.

2.1.12 Pre-Programmed UART Bootloader

The bootloader presented in application note AN0003 is pre-programmed in the device at factory. Auto-baud and destructive write are supported. The autobaud feature, interface and commands are described further in the application note.

2.1.13 Low Energy Universal Asynchronous Receiver/Transmitter (LEUART)

The unique LEUART[™], the Low Energy UART, is a UART that allows two-way UART communication on a strict power budget. Only a 32.768 kHz clock is needed to allow UART communication up to 9600 baud/s. The LEUART includes all necessary hardware support to make asynchronous serial communication possible with minimum of software intervention and energy consumption.

2.1.14 Timer/Counter (TIMER)

The 16-bit general purpose Timer has 3 compare/capture channels for input capture and compare/Pulse-Width Modulation (PWM) output.

2.1.15 Real Time Counter (RTC)

The Real Time Counter (RTC) contains a 24-bit counter and is clocked either by a 32.768 kHz crystal oscillator, or a 32.768 kHz RC oscillator. In addition to energy modes EM0 and EM1, the RTC is also available in EM2. This makes it ideal for keeping track of time since the RTC is enabled in EM2 where most of the device is powered down.

2.1.16 Pulse Counter (PCNT)

The Pulse Counter (PCNT) can be used for counting pulses on a single input or to decode quadrature encoded inputs. It runs off either the internal LFACLK or the PCNTn_S0IN pin as external clock source. The module may operate in energy mode EM0 – EM3.

2.1.17 Analog Comparator (ACMP)

The Analog Comparator is used to compare the voltage of two analog inputs, with a digital output indicating which input voltage is higher. Inputs can either be one of the selectable internal references or from external pins. Response time and thereby also the current consumption can be configured by altering the current supply to the comparator.

2.1.18 Voltage Comparator (VCMP)

The Voltage Supply Comparator is used to monitor the supply voltage from software. An interrupt can be generated when the supply falls below or rises above a programmable threshold. Response time and thereby also the current consumption can be configured by altering the current supply to the comparator.

2.1.19 General Purpose Input/Output (GPIO)

In the EFM32ZG108, there are 17 General Purpose Input/Output (GPIO) pins, which are divided into ports with up to 16 pins each. These pins can individually be configured as either an output or input. More advanced configurations like open-drain, filtering and drive strength can also be configured individually for the pins. The GPIO pins can also be overridden by peripheral pin connections, like Timer PWM outputs or USART communication, which can be routed to several locations on the device. The GPIO supports up to 16 asynchronous external pin interrupts, which enables interrupts from any pin on the device. Also, the input value of a pin can be routed through the Peripheral Reflex System to other peripherals.

2.2 Configuration Summary

The features of the EFM32ZG108 is a subset of the feature set described in the EFM32ZG Reference Manual. Table 2.1 (p. 6) describes device specific implementation of the features.

Table 2.1. Configuration Summary

| Module | Configuration | Pin Connections |
|------------|---|---|
| Cortex-M0+ | Full configuration | NA |
| DBG | Full configuration | DBG_SWCLK, DBG_SWDIO, |
| MSC | Full configuration | NA |
| DMA | Full configuration | NA |
| RMU | Full configuration | NA |
| EMU | Full configuration | NA |
| CMU | Full configuration | CMU_OUT0, CMU_OUT1 |
| WDOG | Full configuration | NA |
| PRS | Full configuration | NA |
| I2C0 | Full configuration | I2C0_SDA, I2C0_SCL |
| USART0 | Full configuration with IrDA and I2S | US0_TX, US0_RX, US0_CLK, US0_CS |
| LEUART0 | Full configuration | LEU0_TX, LEU0_RX |
| TIMER0 | Full configuration | TIM0_CC[2:0] |
| TIMER1 | Full configuration | TIM1_CC[2:0] |
| RTC | Full configuration | NA |
| PCNT0 | Full configuration, 16-bit count register | PCNT0_S[1:0] |
| ACMP0 | Full configuration | ACMP0_CH[1:0], ACMP0_O |
| VCMP | Full configuration | NA |
| GPIO | 17 pins | Available pins are shown in Table 4.3 (p. 37) |

2.3 Memory Map

The *EFM32ZG108* memory map is shown in Figure 2.2 (p. 7), with RAM and Flash sizes for the largest memory configuration.

Figure 2.2. EFM32ZG108 Memory Map with largest RAM and Flash sizes

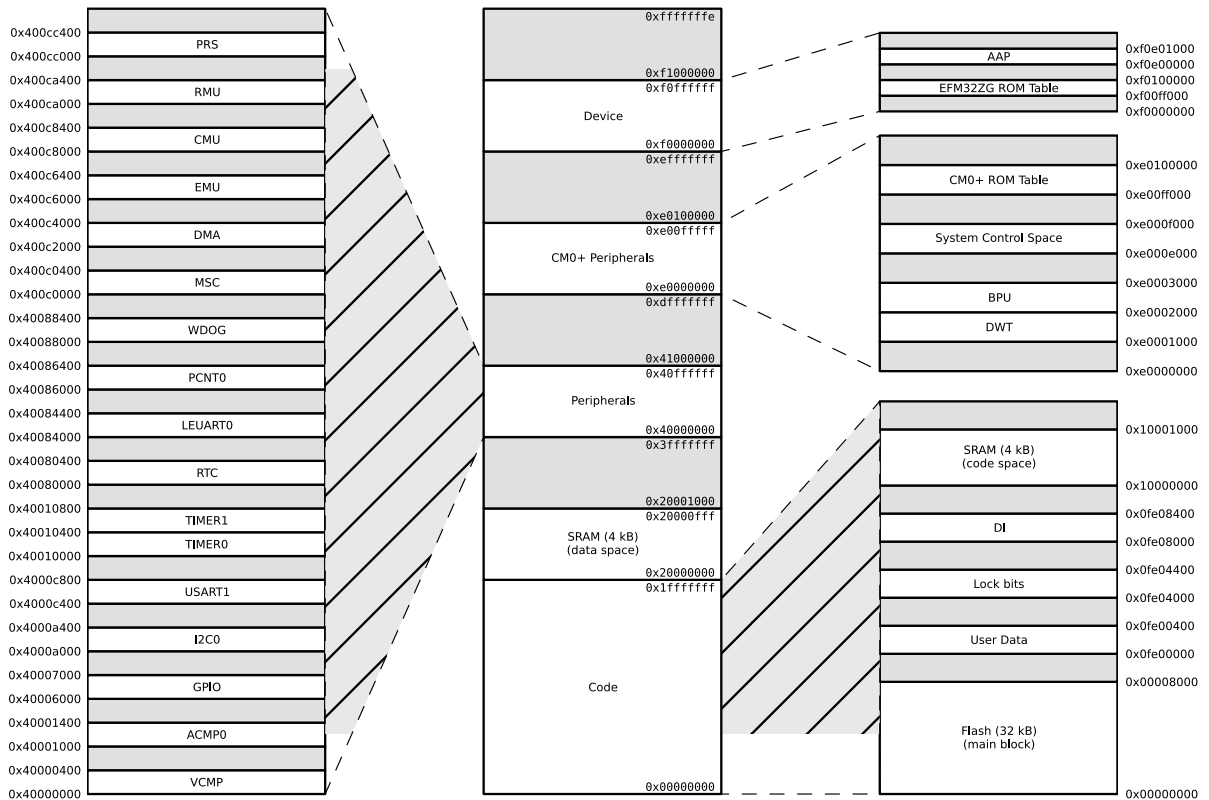

3 Electrical Characteristics

3.1 Test Conditions

3.1.1 Typical Values

The typical data are based on $T_{AMB}=25^{\circ}\text{C}$ and $V_{DD}=3.0\text{ V}$, as defined in Table 3.2 (p. 8), by simulation and/or technology characterisation unless otherwise specified.

3.1.2 Minimum and Maximum Values

The minimum and maximum values represent the worst conditions of ambient temperature, supply voltage and frequencies, as defined in Table 3.2 (p. 8), by simulation and/or technology characterisation unless otherwise specified.

3.2 Absolute Maximum Ratings

The absolute maximum ratings are stress ratings, and functional operation under such conditions are not guaranteed. Stress beyond the limits specified in Table 3.1 (p. 8) may affect the device reliability or cause permanent damage to the device. Functional operating conditions are given in Table 3.2 (p. 8).

Table 3.1. Absolute Maximum Ratings

| Symbol | Parameter | Condition | Min | Typ | Max | Unit |
|-------------|-------------------------------|-------------------------------------|------|-----|------------------|--------------------|
| T_{STG} | Storage temperature range | | -40 | | 150 ¹ | $^{\circ}\text{C}$ |
| T_S | Maximum soldering temperature | Latest IPC/JEDEC J-STD-020 Standard | | | 260 | $^{\circ}\text{C}$ |
| V_{DDMAX} | External main supply voltage | | 0 | | 3.8 | V |
| V_{IOPIN} | Voltage on any I/O pin | | -0.3 | | $V_{DD}+0.3$ | V |

¹Based on programmed devices tested for 10000 hours at 150 $^{\circ}\text{C}$. Storage temperature affects retention of preprogrammed calibration values stored in flash. Please refer to the Flash section in the Electrical Characteristics for information on flash data retention for different temperatures.

3.3 General Operating Conditions

3.3.1 General Operating Conditions

Table 3.2. General Operating Conditions

| Symbol | Parameter | Min | Typ | Max | Unit |
|------------|------------------------------|------|-----|-----|--------------------|
| T_{AMB} | Ambient temperature range | -40 | | 85 | $^{\circ}\text{C}$ |
| V_{DDOP} | Operating supply voltage | 1.85 | | 3.8 | V |
| f_{APB} | Internal APB clock frequency | | | 24 | MHz |
| f_{AHB} | Internal AHB clock frequency | | | 24 | MHz |

3.4 Current Consumption

Table 3.3. Current Consumption

| Symbol | Parameter | Condition | Min | Typ | Max | Unit |
|-----------|---|--|-----|-------|-----|--------------------------|
| I_{EM0} | EM0 current. No prescaling. Running prime number calculation code from Flash. | 24 MHz HFXO, all peripheral clocks disabled, $V_{DD}= 3.0\text{ V}$ | | 114.9 | | $\mu\text{A}/\text{MHz}$ |
| | | 21 MHz HFRCO, all peripheral clocks disabled, $V_{DD}= 3.0\text{ V}$ | | 114.4 | | $\mu\text{A}/\text{MHz}$ |
| | | 14 MHz HFRCO, all peripheral clocks disabled, $V_{DD}= 3.0\text{ V}$ | | 116.6 | | $\mu\text{A}/\text{MHz}$ |
| | | 11 MHz HFRCO, all peripheral clocks disabled, $V_{DD}= 3.0\text{ V}$ | | 118.2 | | $\mu\text{A}/\text{MHz}$ |
| | | 6.6 MHz HFRCO, all peripheral clocks disabled, $V_{DD}= 3.0\text{ V}$ | | 123.5 | | $\mu\text{A}/\text{MHz}$ |
| | | 1.2 MHz HFRCO, all peripheral clocks disabled, $V_{DD}= 3.0\text{ V}$ | | 155.1 | | $\mu\text{A}/\text{MHz}$ |
| I_{EM1} | EM1 current | 24 MHz HFXO, all peripheral clocks disabled, $V_{DD}= 3.0\text{ V}$ | | 48.0 | | $\mu\text{A}/\text{MHz}$ |
| | | 21 MHz HFRCO, all peripheral clocks disabled, $V_{DD}= 3.0\text{ V}$ | | 48.1 | | $\mu\text{A}/\text{MHz}$ |
| | | 14 MHz HFRCO, all peripheral clocks disabled, $V_{DD}= 3.0\text{ V}$ | | 50.1 | | $\mu\text{A}/\text{MHz}$ |
| | | 11 MHz HFRCO, all peripheral clocks disabled, $V_{DD}= 3.0\text{ V}$ | | 51.8 | | $\mu\text{A}/\text{MHz}$ |
| | | 6.6 MHz HFRCO, all peripheral clocks disabled, $V_{DD}= 3.0\text{ V}$ | | 57.1 | | $\mu\text{A}/\text{MHz}$ |
| | | 1.2 MHz HFRCO. all peripheral clocks disabled, $V_{DD}= 3.0\text{ V}$ | | 89.1 | | $\mu\text{A}/\text{MHz}$ |
| I_{EM2} | EM2 current | EM2 current with RTC at 1 Hz, RTC prescaled to 1kHz, 32.768 kHz LFRCO, $V_{DD}= 3.0\text{ V}$, $T_{AMB}=25^{\circ}\text{C}$ | | 0.86 | | μA |
| | | EM2 current with RTC at 1 Hz, RTC prescaled to 1kHz, 32.768 kHz LFRCO, $V_{DD}= 3.0\text{ V}$, $T_{AMB}=85^{\circ}\text{C}$ | | 1.66 | | μA |
| I_{EM3} | EM3 current | $V_{DD}= 3.0\text{ V}$, $T_{AMB}=25^{\circ}\text{C}$ | | 0.49 | | μA |
| | | $V_{DD}= 3.0\text{ V}$, $T_{AMB}=85^{\circ}\text{C}$ | | 1.26 | | μA |
| I_{EM4} | EM4 current | $V_{DD}= 3.0\text{ V}$, $T_{AMB}=25^{\circ}\text{C}$ | | 0.02 | | μA |
| | | $V_{DD}= 3.0\text{ V}$, $T_{AMB}=85^{\circ}\text{C}$ | | 0.29 | | μA |

3.4.1 EM0 Current Consumption

Figure 3.1. EM0 Current consumption while executing prime number calculation code from flash with HFRCO running at 24MHz

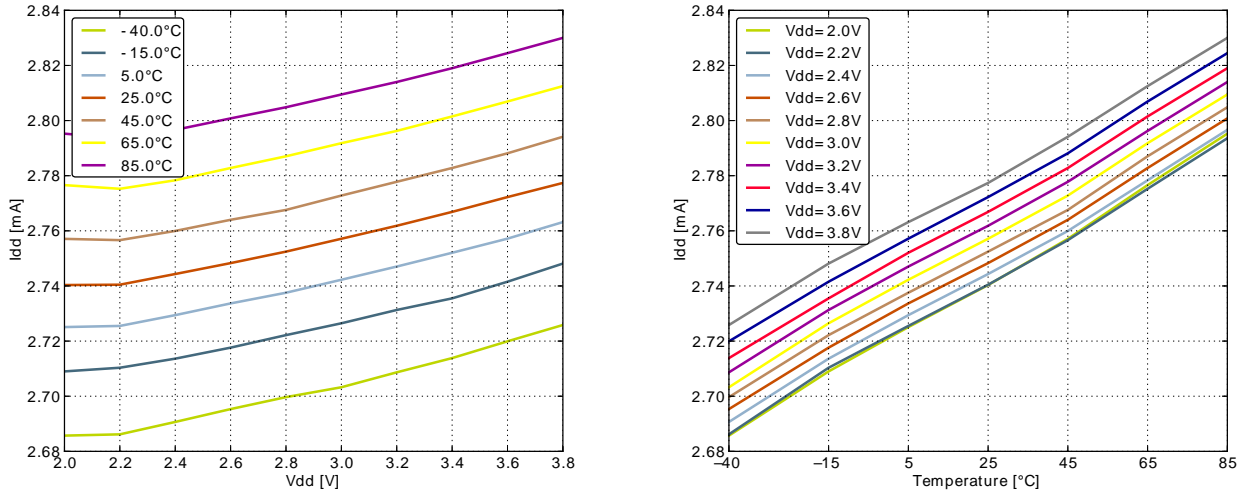

Figure 3.2. EM0 Current consumption while executing prime number calculation code from flash with HFRCO running at 21MHz

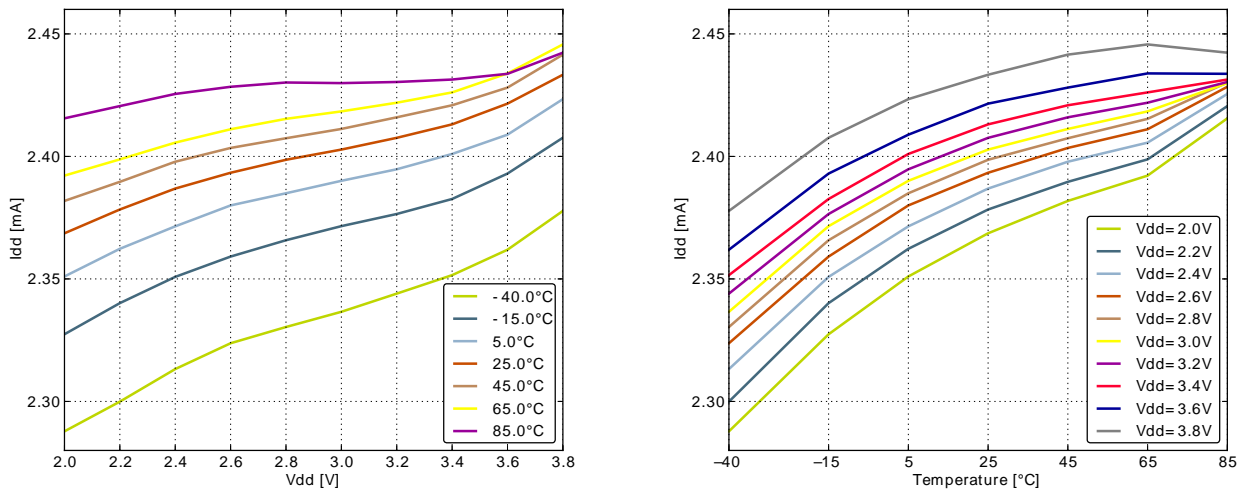

Figure 3.3. EM0 Current consumption while executing prime number calculation code from flash with HFRCO running at 14MHz

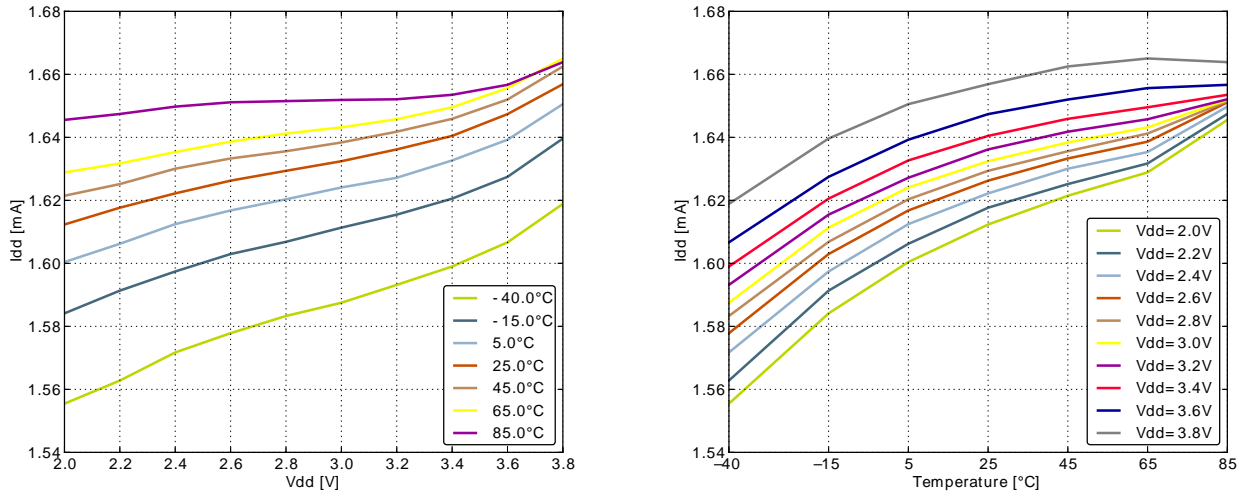

Figure 3.4. EM0 Current consumption while executing prime number calculation code from flash with HFRCO running at 11MHz

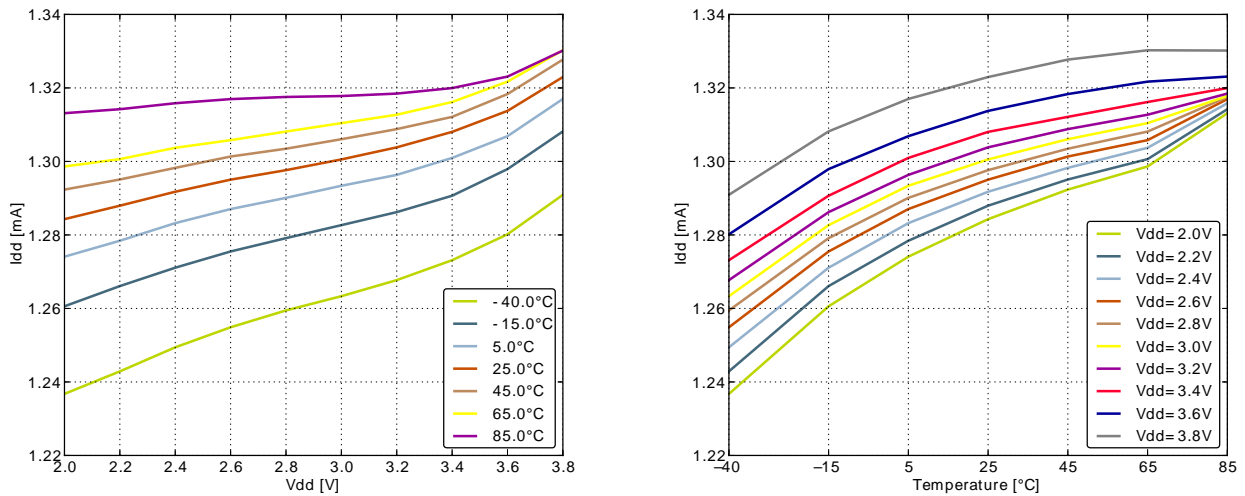
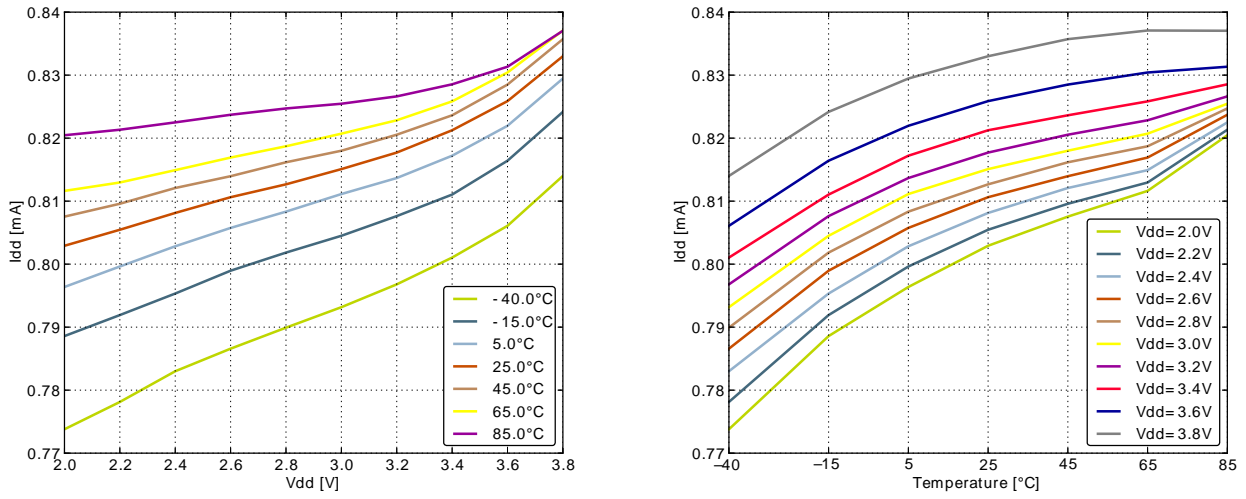

Figure 3.5.



3.4.2 EM1 Current Consumption

Figure 3.6. EM1 Current consumption with all peripheral clocks disabled and HFRCO running at 24MHz

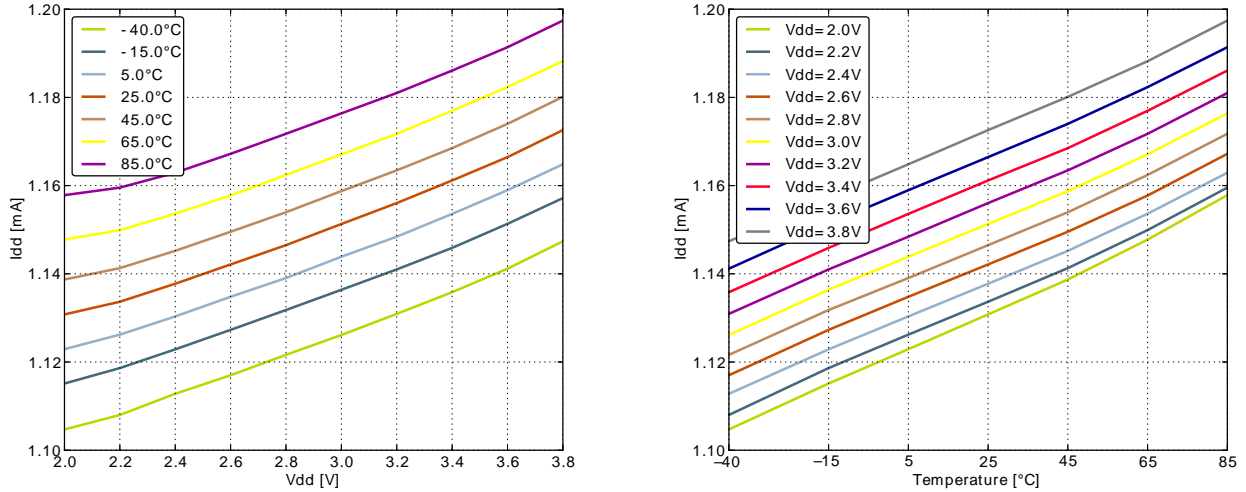

Figure 3.7. EM1 Current consumption with all peripheral clocks disabled and HFRCO running at 21MHz

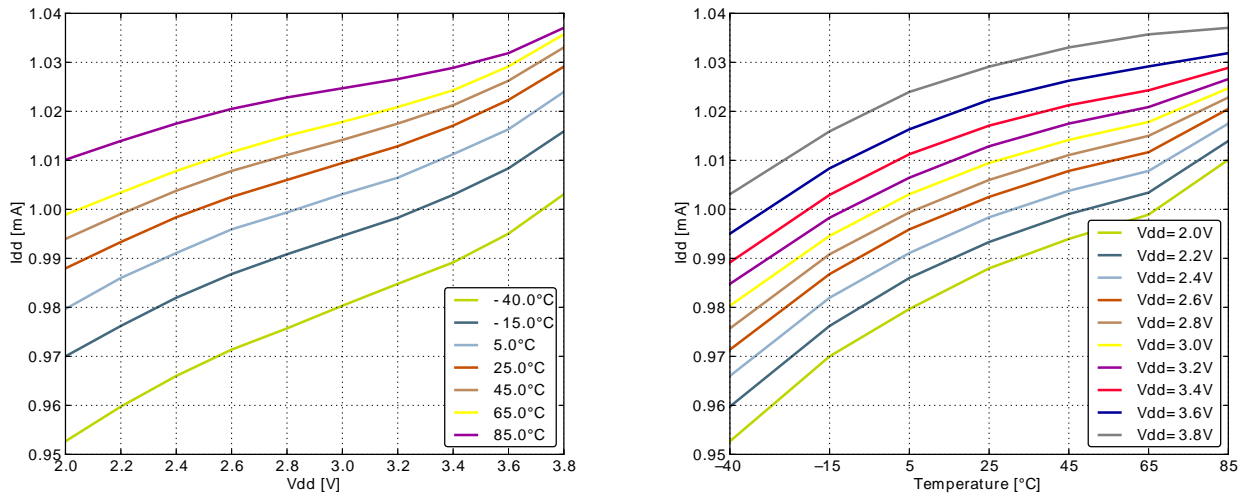

Figure 3.8. EM1 Current consumption with all peripheral clocks disabled and HFRCO running at 14MHz

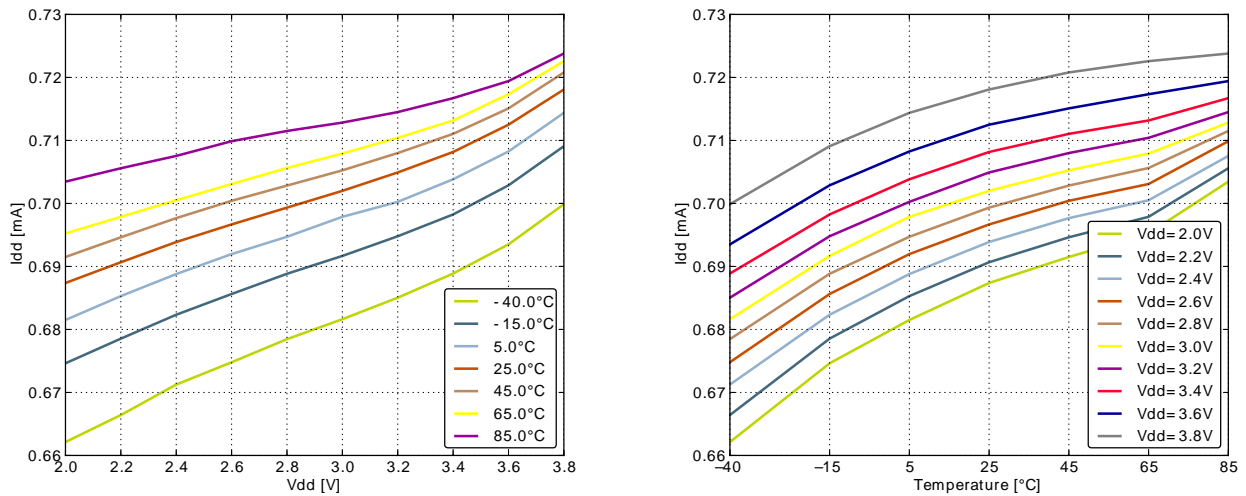

Figure 3.9. EM1 Current consumption with all peripheral clocks disabled and HFRCO running at 11MHz

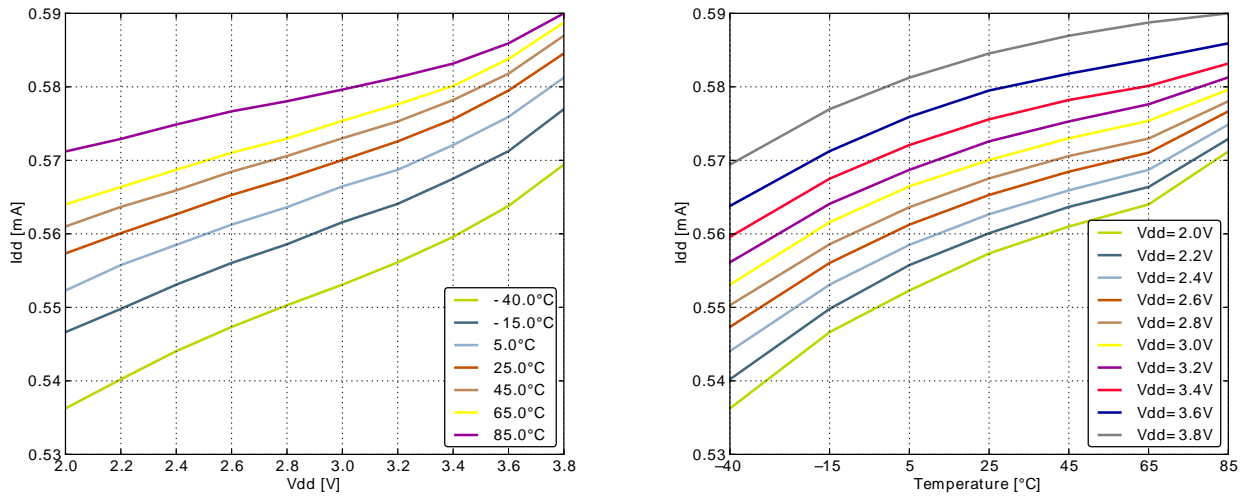
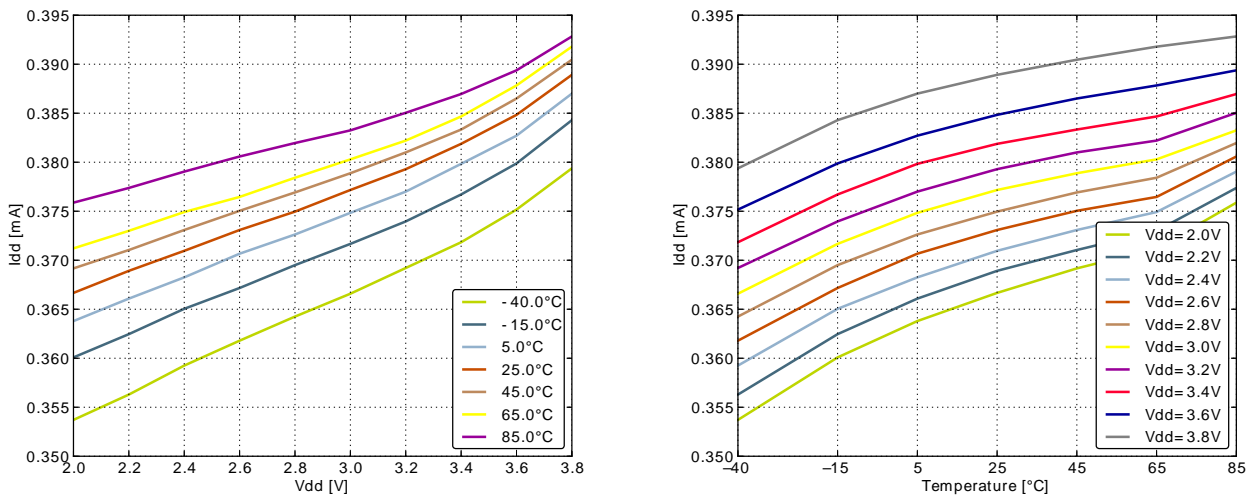
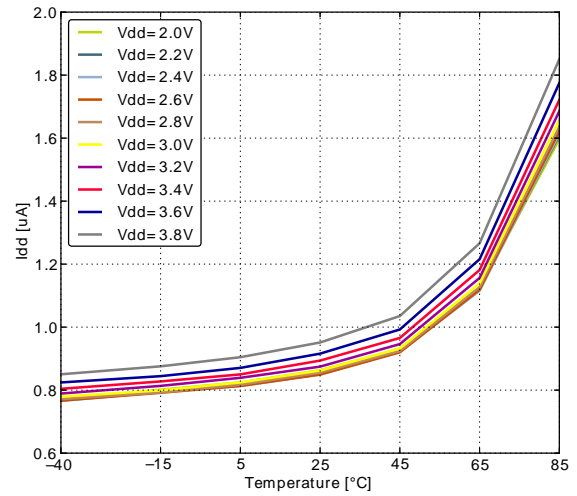
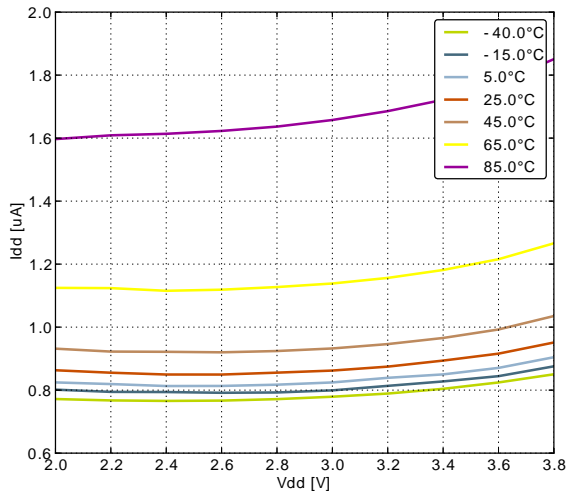

Figure 3.10.



3.4.3 EM2 Current Consumption

Figure 3.11. EM2 current consumption. RTC prescaled to 1kHz, 32.768 kHz LFRCO.



3.4.4 EM3 Current Consumption

Figure 3.12. EM3 current consumption.

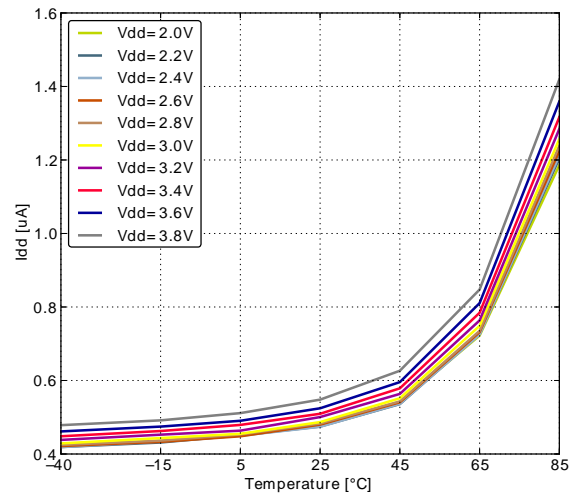
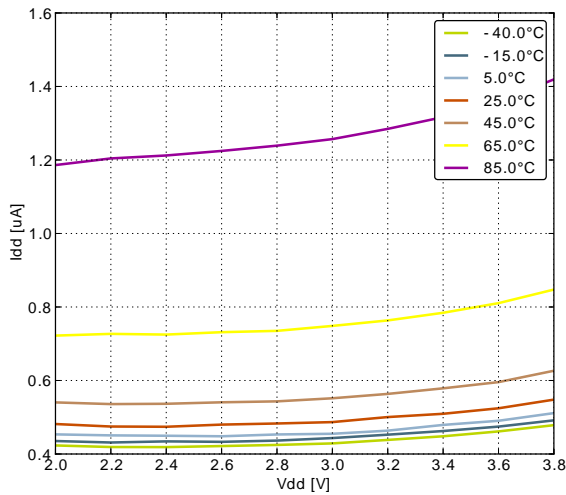

3.4.5 EM4 Current Consumption

Figure 3.13. EM4 current consumption.

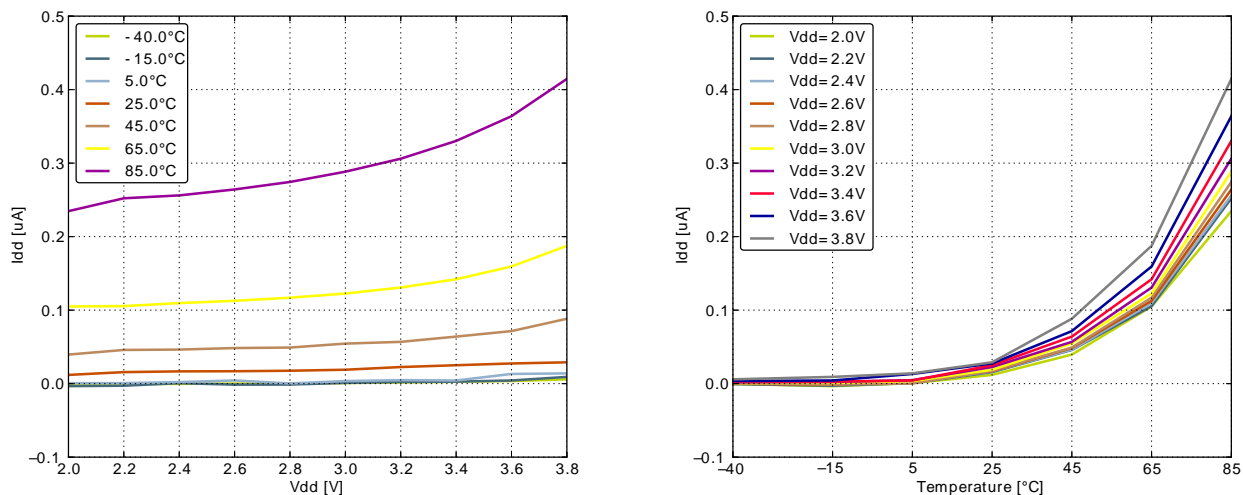

3.5 Transition between Energy Modes

Table 3.4. Energy Modes Transitions

| Symbol | Parameter | Min | Typ | Max | Unit |
|------------|---------------------------------|-----|----------------|-----|--------------------|
| t_{EM10} | Transition time from EM1 to EM0 | | 0 ¹ | | HF core CLK cycles |
| t_{EM20} | Transition time from EM2 to EM0 | | 2 | | μ s |
| t_{EM30} | Transition time from EM3 to EM0 | | 2 | | μ s |
| t_{EM40} | Transition time from EM4 to EM0 | | 163 | | μ s |

¹Core wakeup time only.

3.6 Power Management

The EFM32ZG requires the AVDD_x, VDD_DREG and IOVDD_x pins to be connected together (with optional filter) at the PCB level. For practical schematic recommendations, please see the application note, "AN0002 EFM32 Hardware Design Considerations".

Table 3.5. Power Management

| Symbol | Parameter | Condition | Min | Typ | Max | Unit |
|-------------------------|--|--|------|------|------|------|
| V _{BODextthr-} | BOD threshold on falling external supply voltage | | 1.82 | | 1.85 | V |
| V _{BODintthr-} | BOD threshold on falling internally regulated supply voltage | | 1.62 | | 1.68 | V |
| V _{BODextthr+} | BOD threshold on rising external supply voltage | | | 1.85 | | V |
| t _{RESET} | Delay from reset is released until program execution starts | Applies to Power-on Reset, Brown-out Reset and pin reset. | | 163 | | μs |
| C _{DECOUPLE} | Voltage regulator decoupling capacitor. | X5R capacitor recommended. Apply between DECOUPLE pin and GROUND | | 1 | | μF |

3.7 Flash

Table 3.6. Flash

| Symbol | Parameter | Condition | Min | Typ | Max | Unit |
|----------------------|---|-------------------------|-------|------|----------------|--------|
| EC _{FLASH} | Flash erase cycles before failure | | 20000 | | | cycles |
| RET _{FLASH} | Flash data retention | T _{AMB} <150°C | 10000 | | | h |
| | | T _{AMB} <85°C | 10 | | | years |
| | | T _{AMB} <70°C | 20 | | | years |
| t _{W_PROG} | Word (32-bit) programming time | | 20 | | | μs |
| t _{P_ERASE} | Page erase time | | 20 | 20.4 | 20.8 | ms |
| t _{D_ERASE} | Device erase time | | 40 | 40.8 | 41.6 | ms |
| I _{ERASE} | Erase current | | | | 7 ¹ | mA |
| I _{WRITE} | Write current | | | | 7 ¹ | mA |
| V _{FLASH} | Supply voltage during flash erase and write | | 1.8 | | 3.8 | V |

¹Measured at 25°C

3.8 General Purpose Input Output

Table 3.7. GPIO

| Symbol | Parameter | Condition | Min | Typ | Max | Unit |
|-----------------------|--|---|----------------------|-----|---------------------|------|
| V _{IOIL} | Input low voltage | | | | 0.3V _{DD} | V |
| V _{IOIH} | Input high voltage | | 0.7V _{DD} | | | V |
| V _{IOOH} | Output high voltage | Sourcing 6 mA, V _{DD} =1.85 V, GPIO_Px_CTRL DRIVEMODE = STANDARD | 0.75V _{DD} | | | V |
| | | Sourcing 6 mA, V _{DD} =3.0 V, GPIO_Px_CTRL DRIVEMODE = STANDARD | 0.95V _{DD} | | | V |
| | | Sourcing 20 mA, V _{DD} =1.85 V, GPIO_Px_CTRL DRIVEMODE = HIGH | 0.7V _{DD} | | | V |
| | | Sourcing 20 mA, V _{DD} =3.0 V, GPIO_Px_CTRL DRIVEMODE = HIGH | 0.9V _{DD} | | | V |
| V _{IOOL} | Output low voltage | Sinking 6 mA, V _{DD} =1.85 V, GPIO_Px_CTRL DRIVEMODE = STANDARD | | | 0.25V _{DD} | V |
| | | Sinking 6 mA, V _{DD} =3.0 V, GPIO_Px_CTRL DRIVEMODE = STANDARD | | | 0.05V _{DD} | V |
| | | Sinking 20 mA, V _{DD} =1.85 V, GPIO_Px_CTRL DRIVEMODE = HIGH | | | 0.3V _{DD} | V |
| | | Sinking 20 mA, V _{DD} =3.0 V, GPIO_Px_CTRL DRIVEMODE = HIGH | | | 0.1V _{DD} | V |
| I _{IOLEAK} | Input leakage current | High Impedance IO connected to GROUND or V _{DD} | | | +/-25 | nA |
| R _{PU} | I/O pin pull-up resistor | | | 40 | | kOhm |
| R _{PD} | I/O pin pull-down resistor | | | 40 | | kOhm |
| R _{IOESD} | Internal ESD series resistor | | | 200 | | Ohm |
| t _{IOGLITCH} | Pulse width of pulses to be removed by the glitch suppression filter | | 10 | | 50 | ns |
| t _{IOOF} | Output fall time | 0.5 mA drive strength and load capacitance C _L =12.5-25pF. | 20+0.1C _L | | 250 | ns |
| | | 2mA drive strength and load capacitance C _L =350-600pF | 20+0.1C _L | | 250 | ns |
| V _{IOHYST} | I/O pin hysteresis (V _{IOTHR+} - V _{IOTHR-}) | V _{DD} = 1.85 - 3.8 V | 0.1V _{DD} | | | V |

Figure 3.14. Typical Low-Level Output Current, 2V Supply Voltage

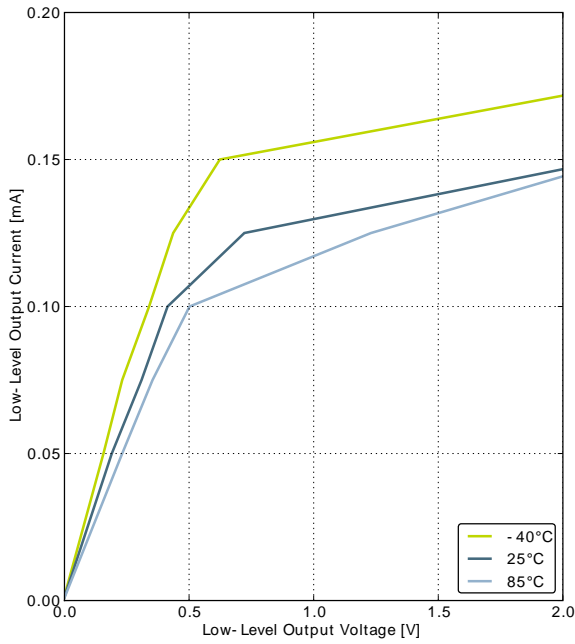

GPIO_Px_CTRL DRIVEMODE = LOWEST

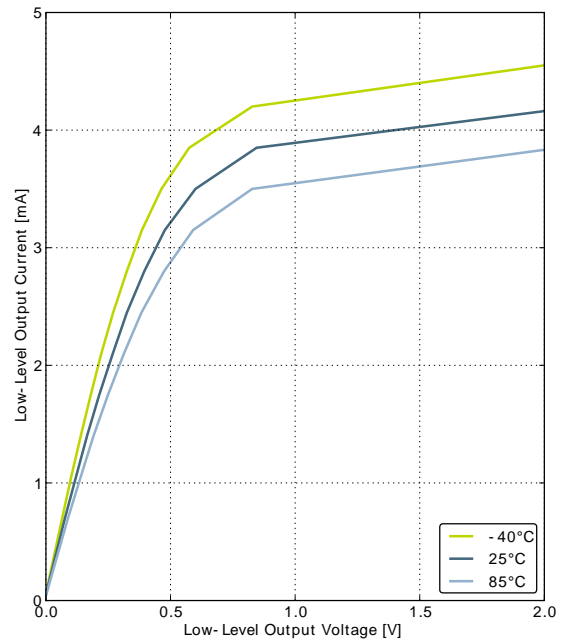

GPIO_Px_CTRL DRIVEMODE = LOW

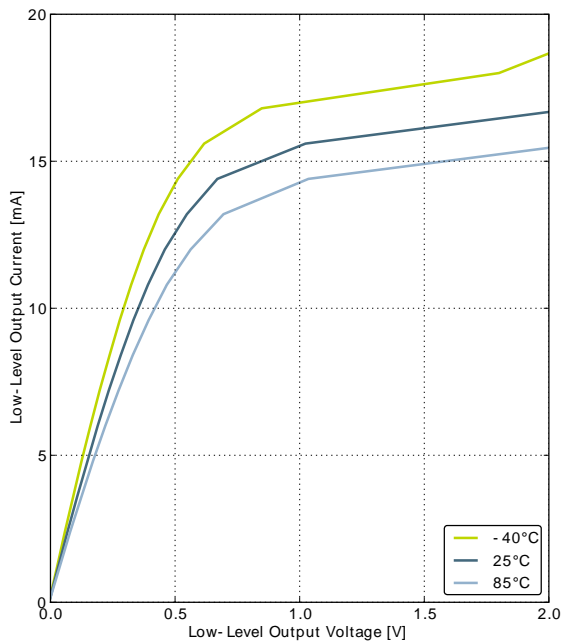

GPIO_Px_CTRL DRIVEMODE = STANDARD

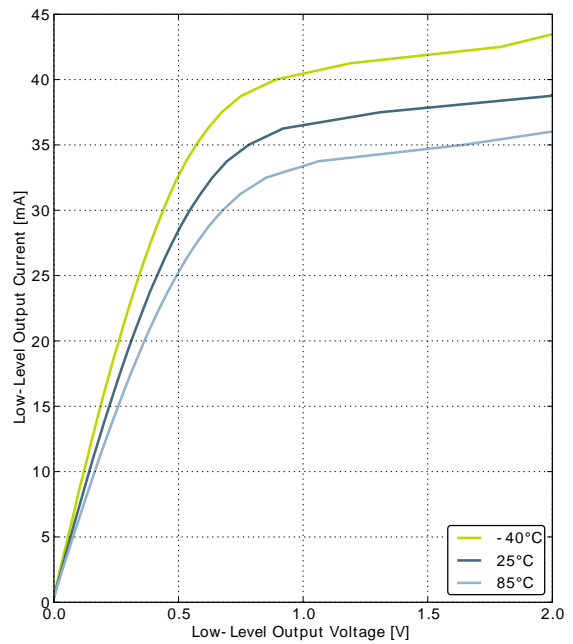

GPIO_Px_CTRL DRIVEMODE = HIGH

Figure 3.15. Typical High-Level Output Current, 2V Supply Voltage

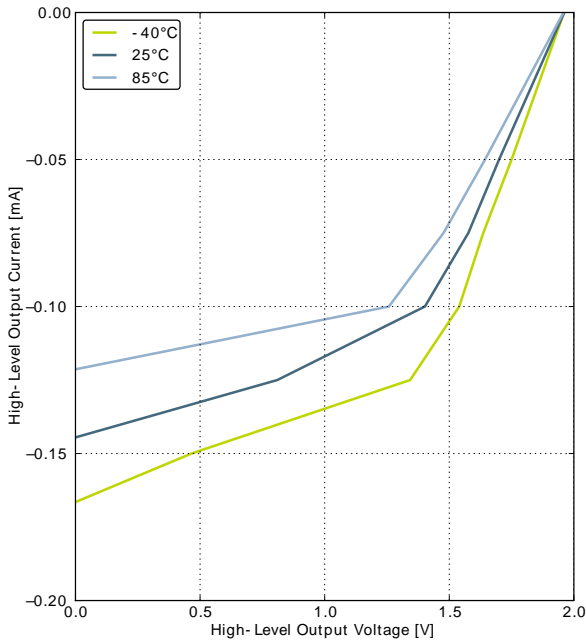

GPIO_Px_CTRL DRIVEMODE = LOWEST

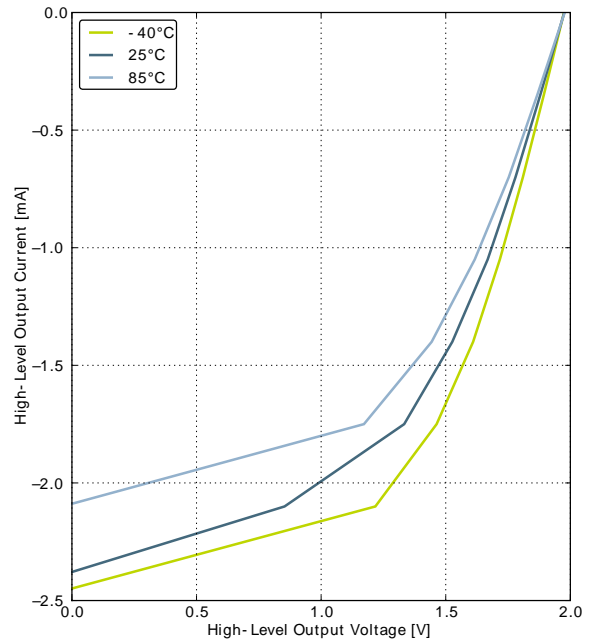

GPIO_Px_CTRL DRIVEMODE = LOW

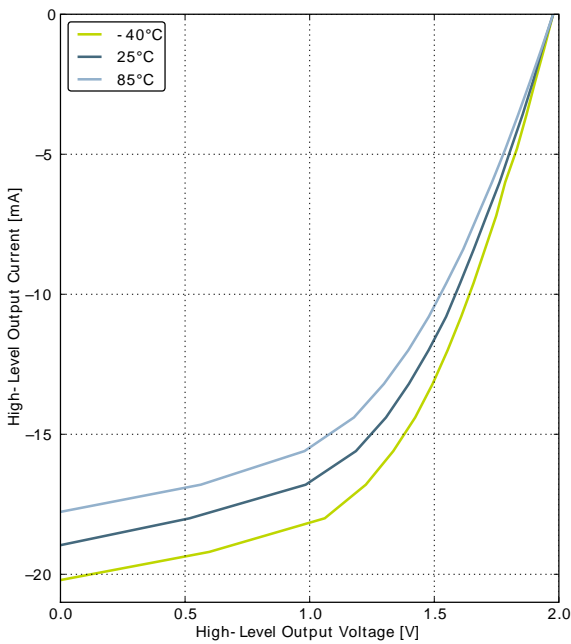

GPIO_Px_CTRL DRIVEMODE = STANDARD

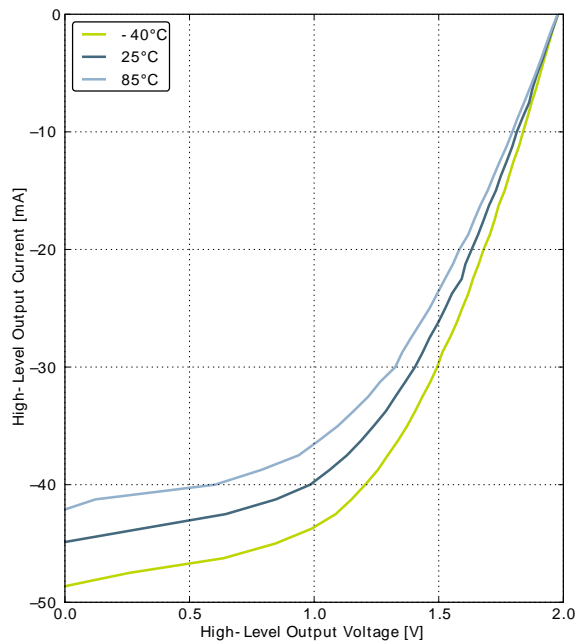

GPIO_Px_CTRL DRIVEMODE = HIGH

Figure 3.16. Typical Low-Level Output Current, 3V Supply Voltage

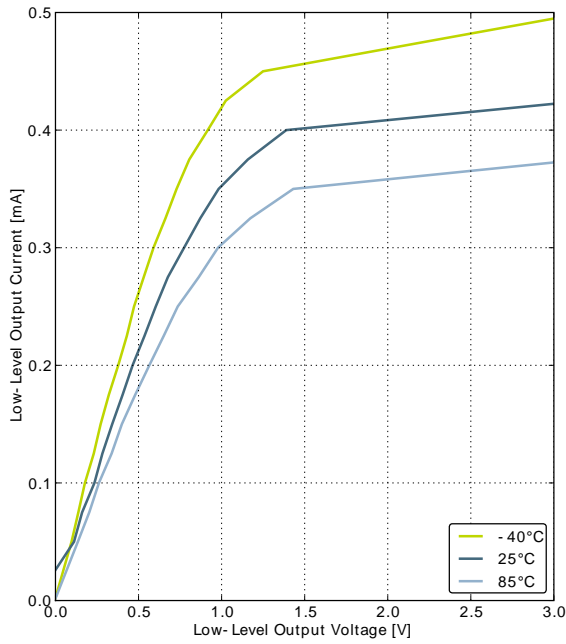

GPIO_Px_CTRL DRIVEMODE = LOWEST

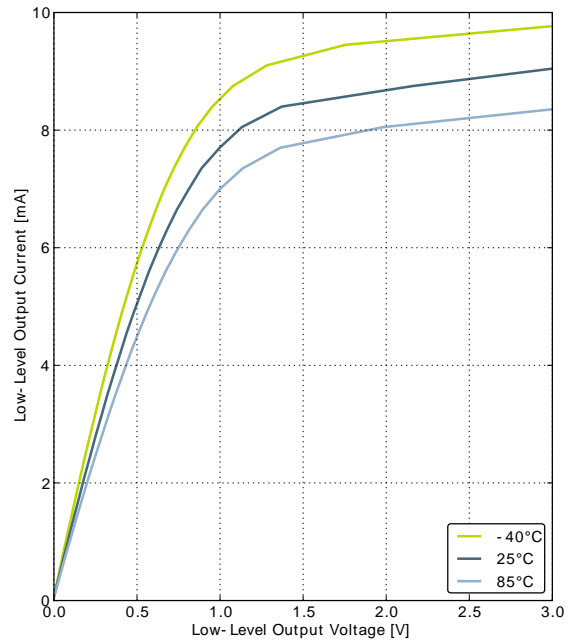

GPIO_Px_CTRL DRIVEMODE = LOW

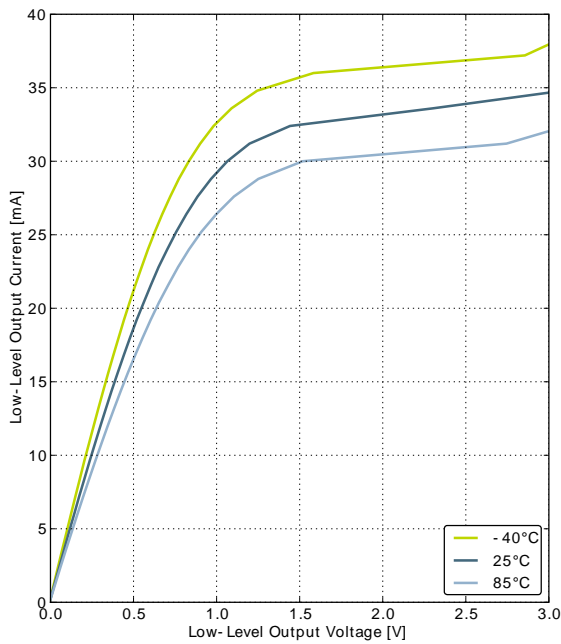

GPIO_Px_CTRL DRIVEMODE = STANDARD

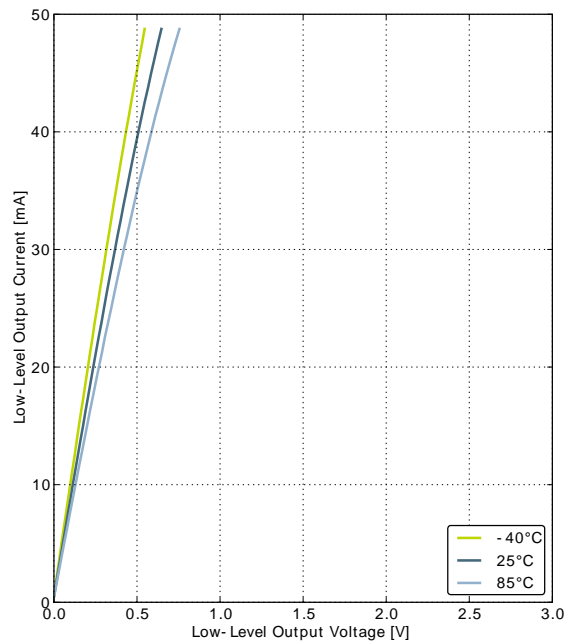

GPIO_Px_CTRL DRIVEMODE = HIGH

Figure 3.17. Typical High-Level Output Current, 3V Supply Voltage

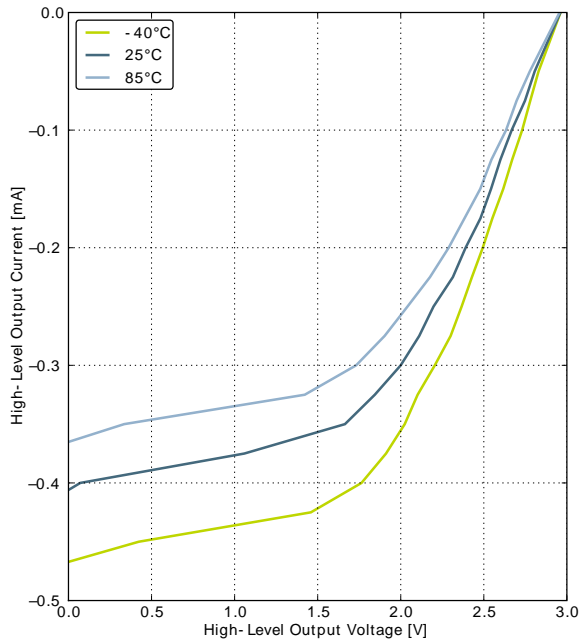

GPIO_Px_CTRL DRIVEMODE = LOWEST

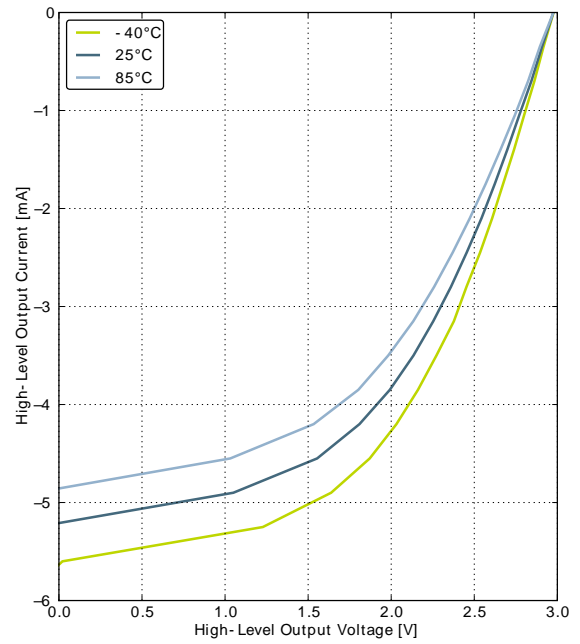

GPIO_Px_CTRL DRIVEMODE = LOW

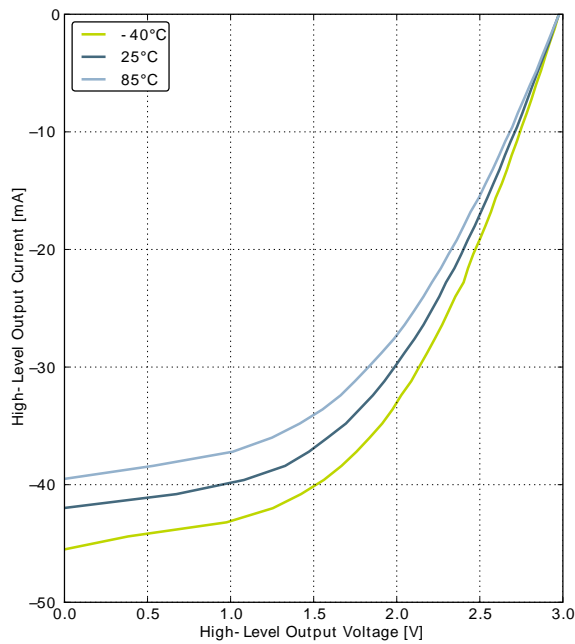

GPIO_Px_CTRL DRIVEMODE = STANDARD

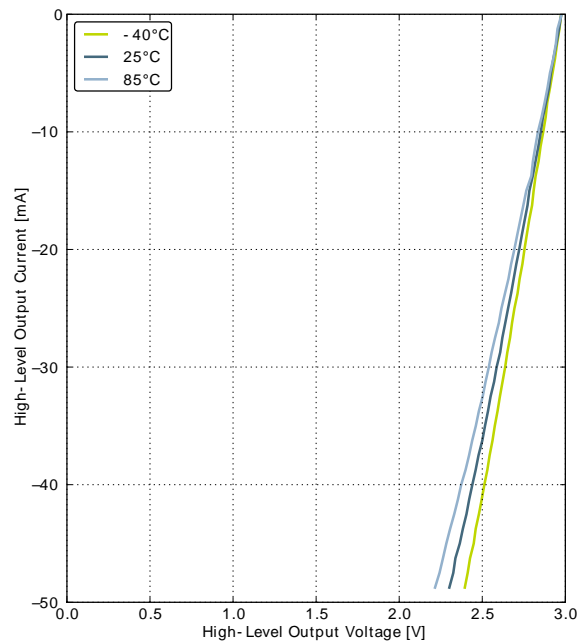

GPIO_Px_CTRL DRIVEMODE = HIGH

Figure 3.18. Typical Low-Level Output Current, 3.8V Supply Voltage

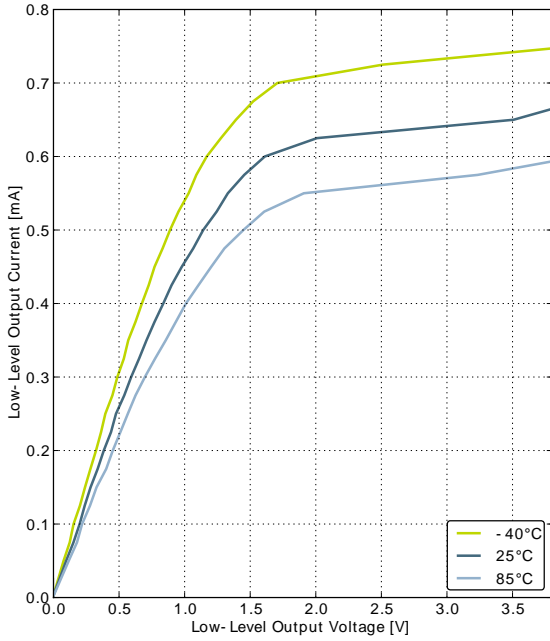

GPIO_Px_CTRL DRIVEMODE = LOWEST

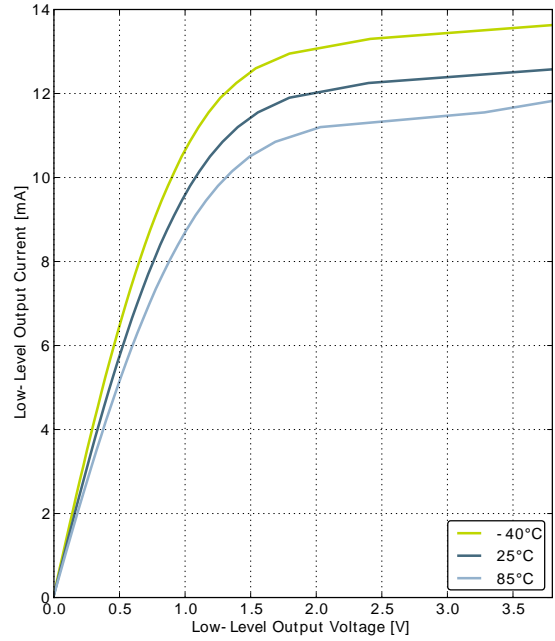

GPIO_Px_CTRL DRIVEMODE = LOW

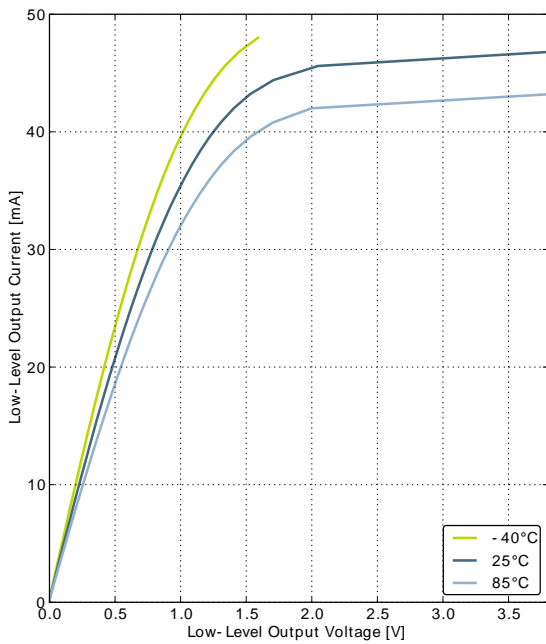

GPIO_Px_CTRL DRIVEMODE = STANDARD

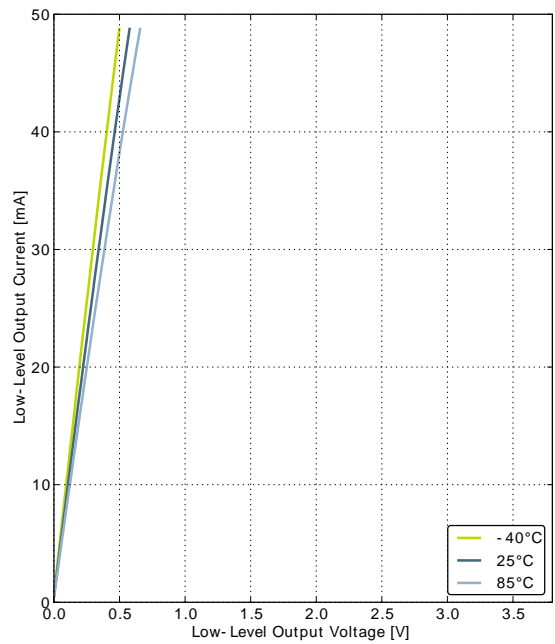

GPIO_Px_CTRL DRIVEMODE = HIGH

Figure 3.19. Typical High-Level Output Current, 3.8V Supply Voltage

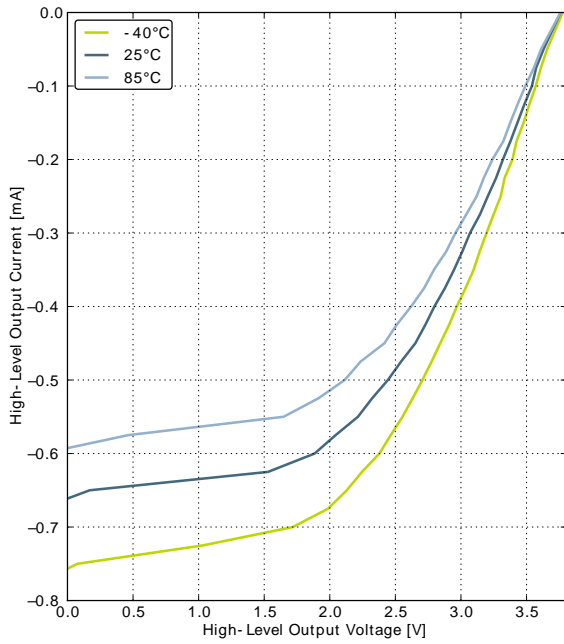

GPIO_Px_CTRL DRIVEMODE = LOWEST

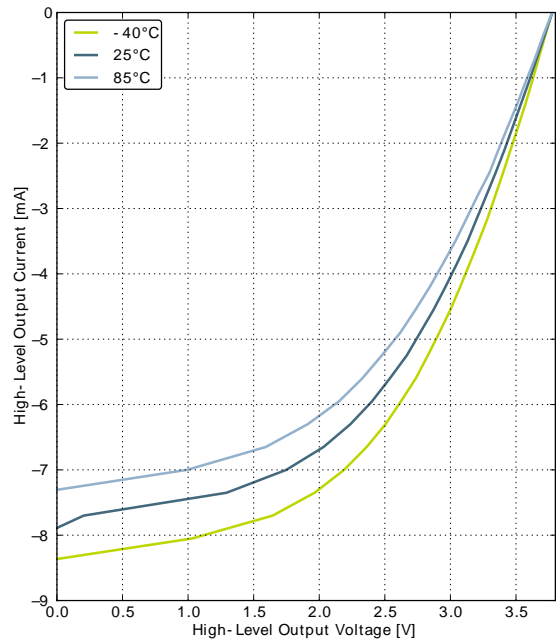

GPIO_Px_CTRL DRIVEMODE = LOW

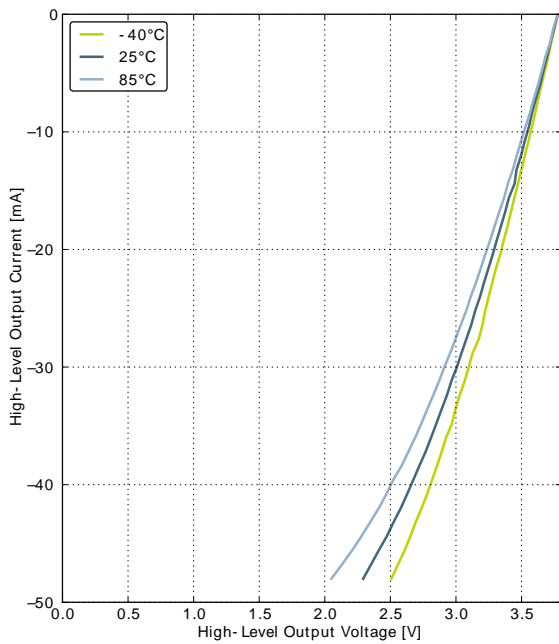

GPIO_Px_CTRL DRIVEMODE = STANDARD

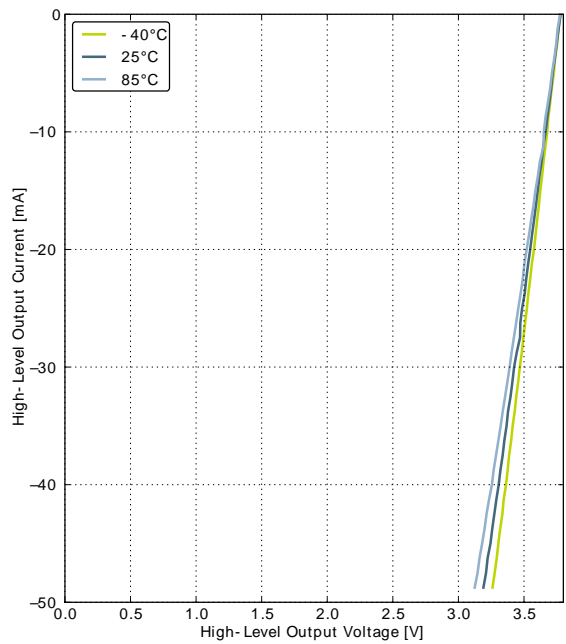

GPIO_Px_CTRL DRIVEMODE = HIGH

3.9 Oscillators

3.9.1 LFXO

Table 3.8. LFXO

| Symbol | Parameter | Condition | Min | Typ | Max | Unit |
|---------------------|--|---|-----|--------|------|------|
| f _{LFXO} | Supported nominal crystal frequency | | | 32.768 | | kHz |
| ESR _{LFXO} | Supported crystal equivalent series resistance (ESR) | | | 30 | 120 | kOhm |
| C _{LFXOL} | Supported crystal external load range | | 5 | | 25 | pF |
| DC _{LFXO} | Duty cycle | | 48 | 50 | 53.5 | % |
| I _{LFXO} | Current consumption for core and buffer after startup. | ESR=30 kOhm, C _L =10 pF, LFXOBOOST in CMU_CTRL is 1 | | 190 | | nA |
| t _{LFXO} | Start- up time. | ESR=30 kOhm, C _L =10 pF, 40% - 60% duty cycle has been reached, LFXOBOOST in CMU_CTRL is 1 | | 400 | | ms |

For safe startup of a given crystal, the energyAware Designer in Simplicity Studio contains a tool to help users configure both load capacitance and software settings for using the LFXO. For details regarding the crystal configuration, the reader is referred to application note "AN0016 EFM32 Oscillator Design Consideration".

3.9.2 HFXO

Table 3.9. HFXO

| Symbol | Parameter | Condition | Min | Typ | Max | Unit |
|---------------------|--|--|-----|-----|------|------|
| f _{HFXO} | Supported nominal crystal Frequency | | 4 | | 24 | MHz |
| ESR _{HFXO} | Supported crystal equivalent series resistance (ESR) | Crystal frequency 24 MHz | | 30 | 60 | Ohm |
| | | Crystal frequency 4 MHz | | 400 | 1500 | Ohm |
| g _{mHFXO} | The transconductance of the HFXO input transistor at crystal startup | HFXOBOOST in CMU_CTRL equals 0b11 | 20 | | | mS |
| C _{HFXOL} | Supported crystal external load range | | 5 | | 25 | pF |
| DC _{HFXO} | Duty cycle | | 46 | 50 | 54 | % |
| I _{HFXO} | Current consumption for HFXO after startup | 4 MHz: ESR=400 Ohm, C _L =20 pF, HFXOBOOST in CMU_CTRL equals 0b11 | | 85 | | μA |
| | | 24 MHz: ESR=30 Ohm, C _L =10 pF, HFXOBOOST in CMU_CTRL equals 0b11 | | 165 | | μA |
| t _{HFXO} | Startup time | 24 MHz: ESR=30 Ohm, C _L =10 pF, HFXOBOOST in CMU_CTRL equals 0b11 | | 400 | | μs |

3.9.3 LFRCO

Table 3.10. LFRCO

| Symbol | Parameter | Condition | Min | Typ | Max | Unit |
|----------------|---|-----------|-----|--------|-----|---------------|
| f_{LFRCO} | Oscillation frequency, $V_{DD}=3.0\text{ V}$, $T_{AMB}=25^\circ\text{C}$ | | | 32.768 | | kHz |
| t_{LFRCO} | Startup time not including software calibration | | | 150 | | μs |
| I_{LFRCO} | Current consumption | | | 190 | | nA |
| TUNESTEP_LFRCO | Frequency step for LSB change in TUNING value | | | 1.5 | | % |

Figure 3.20. Calibrated LFRCO Frequency vs Temperature and Supply Voltage

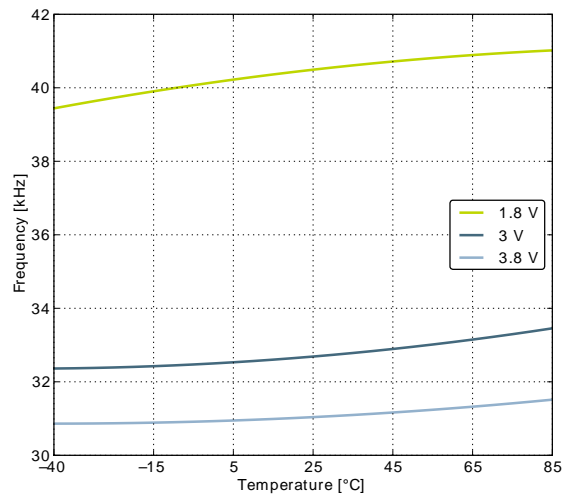
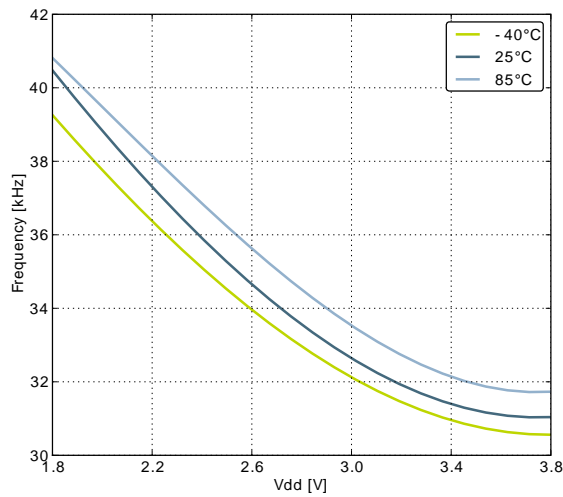

3.9.4 HFRCO

Table 3.11. HFRCO

| Symbol | Parameter | Condition | Min | Typ | Max | Unit |
|----------------------------------|---|-------------------------------------|------|-----|-----|---------------|
| f_{HFRCO} | Oscillation frequency, $V_{\text{DD}}=3.0\text{ V}$, $T_{\text{AMB}}=25^{\circ}\text{C}$ | 21 MHz frequency band | | 21 | | MHz |
| | | 14 MHz frequency band | | 14 | | MHz |
| | | 11 MHz frequency band | | 11 | | MHz |
| | | 7 MHz frequency band | | 6.6 | | MHz |
| | | 1 MHz frequency band | | 1.2 | | MHz |
| $t_{\text{HFRCO_settling}}$ | Settling time after start-up | $f_{\text{HFRCO}} = 14\text{ MHz}$ | | 0.6 | | Cycles |
| I_{HFRCO} | Current consumption | $f_{\text{HFRCO}} = 21\text{ MHz}$ | | 93 | | μA |
| | | $f_{\text{HFRCO}} = 14\text{ MHz}$ | | 77 | | μA |
| | | $f_{\text{HFRCO}} = 11\text{ MHz}$ | | 72 | | μA |
| | | $f_{\text{HFRCO}} = 6.6\text{ MHz}$ | | 63 | | μA |
| | | $f_{\text{HFRCO}} = 1.2\text{ MHz}$ | | 22 | | μA |
| DC_{HFRCO} | Duty cycle | $f_{\text{HFRCO}} = 14\text{ MHz}$ | 48.5 | 50 | 51 | % |
| $\text{TUNESTEP}_{\text{HFRCO}}$ | Frequency step for LSB change in TUNING value | | | 0.3 | | % |

Figure 3.21. Calibrated HFRCO 11 MHz Band Frequency vs Supply Voltage and Temperature

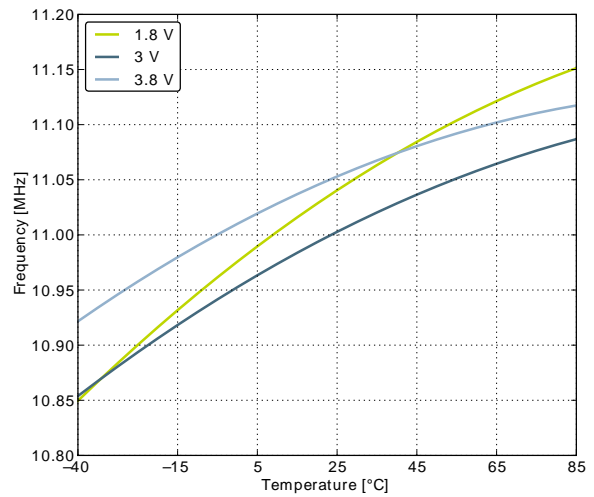
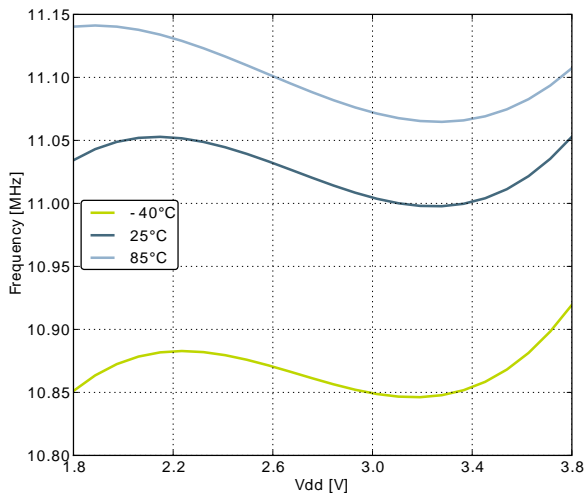

Figure 3.22. Calibrated HFRCO 14 MHz Band Frequency vs Supply Voltage and Temperature

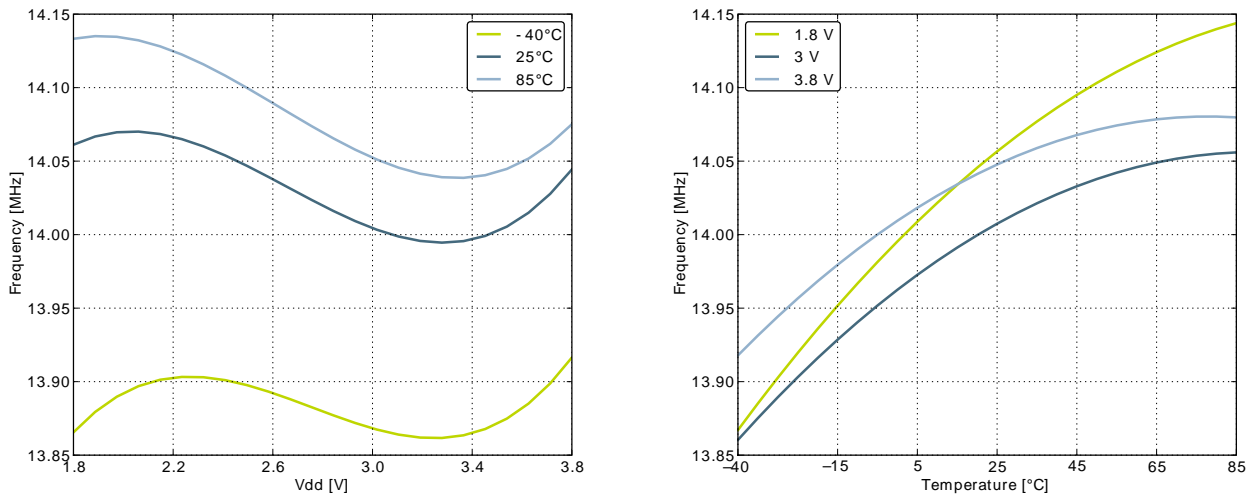
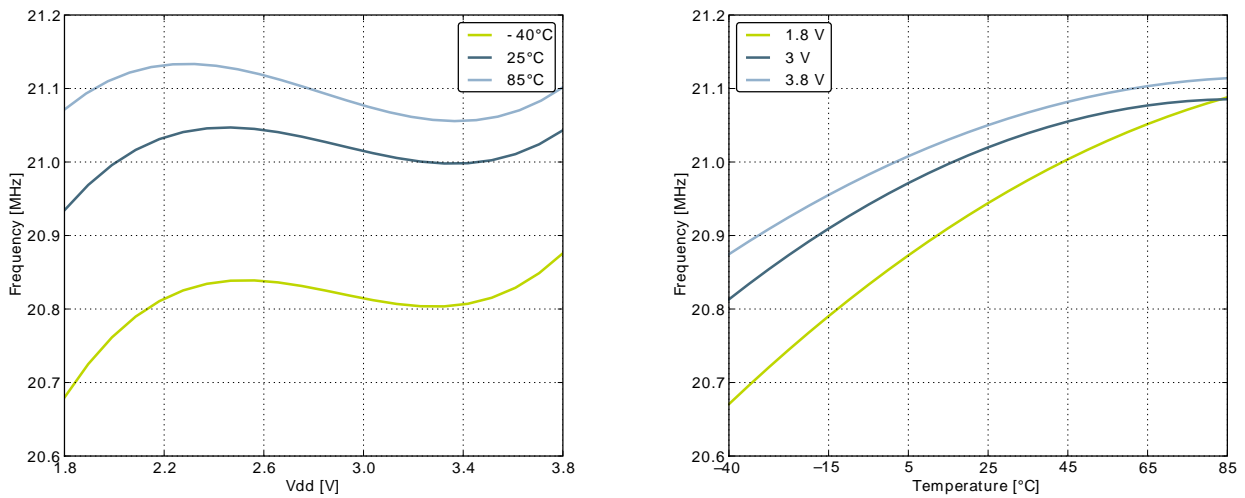

Figure 3.23. Calibrated HFRCO 21 MHz Band Frequency vs Supply Voltage and Temperature



3.9.5 ULFRCO

Table 3.12. ULFRCO

| Symbol | Parameter | Condition | Min | Typ | Max | Unit |
|---------------|----------------------------|-----------|-----|-------|-----|------|
| f_{ULFRCO} | Oscillation frequency | 25°C, 3V | 0.8 | | 1.5 | kHz |
| TC_{ULFRCO} | Temperature coefficient | | | 0.05 | | %/°C |
| VC_{ULFRCO} | Supply voltage coefficient | | | -18.2 | | %/V |

3.10 Analog Comparator (ACMP)

Table 3.13. ACMP

| Symbol | Parameter | Condition | Min | Typ | Max | Unit |
|-------------------------|---|--|-----|------|-----------------|------|
| V _{ACMPIN} | Input voltage range | | 0 | | V _{DD} | V |
| V _{ACMPCM} | ACMP Common Mode voltage range | | 0 | | V _{DD} | V |
| I _{ACMP} | Active current | BIASPROG=0b0000, FULL-BIAS=0 and HALFBIAS=1 in ACMPn_CTRL register | | 0.1 | | μA |
| | | BIASPROG=0b1111, FULL-BIAS=0 and HALFBIAS=0 in ACMPn_CTRL register | | 2.87 | | μA |
| | | BIASPROG=0b1111, FULL-BIAS=1 and HALFBIAS=0 in ACMPn_CTRL register | | 195 | | μA |
| I _{ACMPREF} | Current consumption of internal voltage reference | Internal voltage reference off. Using external voltage reference | | 0 | | μA |
| | | Internal voltage reference | | 5 | | μA |
| V _{ACMPOFFSET} | Offset voltage | Single ended | | 10 | | mV |
| | | Differential | | 10 | | mV |
| V _{ACMPHYST} | ACMP hysteresis | Programmable | | 17 | | mV |
| R _{CSRES} | Capacitive Sense Internal Resistance | CSRESSEL=0b00 in ACMPn_INPUTSEL | | 39 | | kOhm |
| | | CSRESSEL=0b01 in ACMPn_INPUTSEL | | 71 | | kOhm |
| | | CSRESSEL=0b10 in ACMPn_INPUTSEL | | 104 | | kOhm |
| | | CSRESSEL=0b11 in ACMPn_INPUTSEL | | 136 | | kOhm |
| t _{ACMPSTART} | Startup time | | | | 10 | μs |

The total ACMP current is the sum of the contributions from the ACMP and its internal voltage reference as given in Equation 3.1 (p. 29) . I_{ACMPREF} is zero if an external voltage reference is used.

Total ACMP Active Current

$$I_{ACMPTOTAL} = I_{ACMP} + I_{ACMPREF} \quad (3.1)$$

Figure 3.24. ACMP Characteristics, Vdd = 3V, Temp = 25°C, FULLBIAS = 0, HALFBIAS = 1

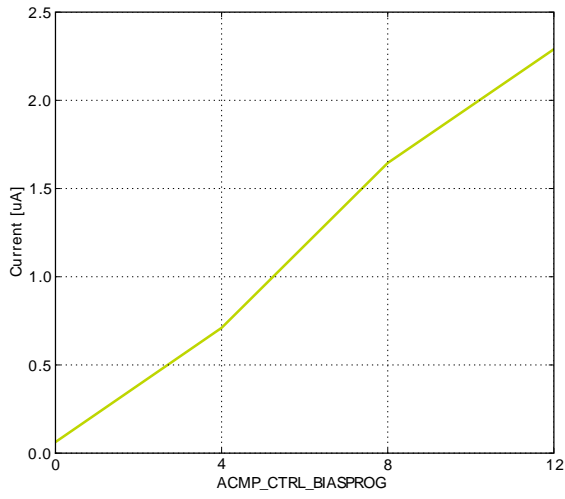

Current consumption, HYSTSEL = 4

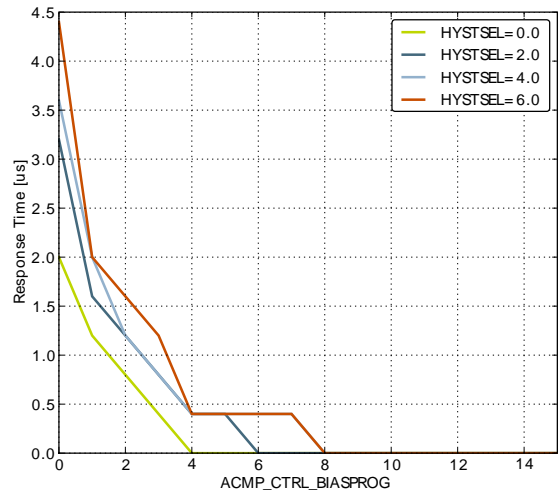

Response time

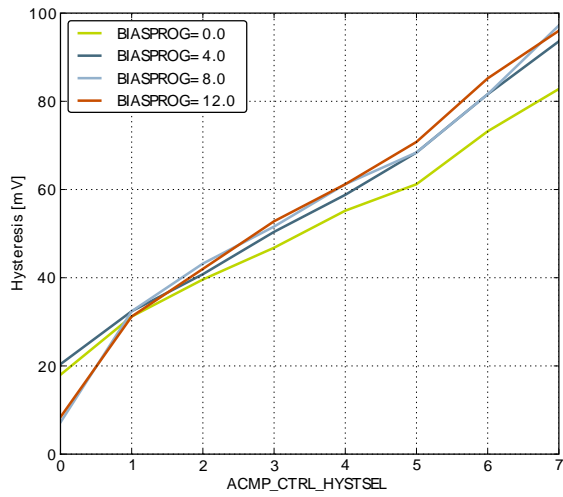

Hysteresis

3.11 Voltage Comparator (VCMP)

Table 3.14. VCMP

| Symbol | Parameter | Condition | Min | Typ | Max | Unit |
|------------------------------------|----------------------------------|---|-----|-----------------|-----|------|
| V _{VCMPIN} | Input voltage range | | | V _{DD} | | V |
| V _{VCMP_{CM}} | VCMP Common Mode voltage range | | | V _{DD} | | V |
| I _{VCMP} | Active current | BIASPROG=0b0000 and HALFBIAS=1 in VCMPn_CTRL register | | 0.1 | | μA |
| | | BIASPROG=0b1111 and HALFBIAS=0 in VCMPn_CTRL register. LPREF=0. | | 14.7 | | μA |
| t _{VCMPREF} | Startup time reference generator | NORMAL | | 10 | | μs |
| V _{VCMP_{OFFSET}} | Offset voltage | Single ended | | 10 | | mV |
| | | Differential | | 10 | | mV |
| V _{VCMPHYST} | VCMP hysteresis | | | 17 | | mV |
| t _{VCMPSTART} | Startup time | | | | 10 | μs |

The V_{DD} trigger level can be configured by setting the TRIGLEVEL field of the VCMP_CTRL register in accordance with the following equation:

VCMP Trigger Level as a Function of Level Setting

$$V_{DD \text{ Trigger Level}} = 1.667V + 0.034 \times \text{TRIGLEVEL} \quad (3.2)$$

3.12 I2C

Table 3.15. I2C Standard-mode (Sm)

| Symbol | Parameter | Min | Typ | Max | Unit |
|---------------------|--|-----|-----|---------------------|------|
| f _{SCL} | SCL clock frequency | 0 | | 100 ¹ | kHz |
| t _{LOW} | SCL clock low time | 4.7 | | | μs |
| t _{HIGH} | SCL clock high time | 4.0 | | | μs |
| t _{SU,DAT} | SDA set-up time | 250 | | | ns |
| t _{HD,DAT} | SDA hold time | 8 | | 3450 ^{2,3} | ns |
| t _{SU,STA} | Repeated START condition set-up time | 4.7 | | | μs |
| t _{HD,STA} | (Repeated) START condition hold time | 4.0 | | | μs |
| t _{SU,STO} | STOP condition set-up time | 4.0 | | | μs |
| t _{BUF} | Bus free time between a STOP and START condition | 4.7 | | | μs |

¹For the minimum HPPERCLK frequency required in Standard-mode, see the I2C chapter in the EFM32ZG Reference Manual.

²The maximum SDA hold time (t_{HD,DAT}) needs to be met only when the device does not stretch the low time of SCL (t_{LOW}).

³When transmitting data, this number is guaranteed only when I2Cn_CLKDIV < ((3450*10⁻⁹ [s] * f_{HPPERCLK} [Hz]) - 5).

Table 3.16. I2C Fast-mode (Fm)

| Symbol | Parameter | Min | Typ | Max | Unit |
|---------------------|--|-----|-----|--------------------|------|
| f _{SCL} | SCL clock frequency | 0 | | 400 ¹ | kHz |
| t _{LOW} | SCL clock low time | 1.3 | | | μs |
| t _{HIGH} | SCL clock high time | 0.6 | | | μs |
| t _{SU,DAT} | SDA set-up time | 100 | | | ns |
| t _{HD,DAT} | SDA hold time | 8 | | 900 ^{2,3} | ns |
| t _{SU,STA} | Repeated START condition set-up time | 0.6 | | | μs |
| t _{HD,STA} | (Repeated) START condition hold time | 0.6 | | | μs |
| t _{SU,STO} | STOP condition set-up time | 0.6 | | | μs |
| t _{BUF} | Bus free time between a STOP and START condition | 1.3 | | | μs |

¹For the minimum HFPERCLK frequency required in Fast-mode, see the I2C chapter in the EFM32ZG Reference Manual.

²The maximum SDA hold time (t_{HD,DAT}) needs to be met only when the device does not stretch the low time of SCL (t_{LOW}).

³When transmitting data, this number is guaranteed only when I2Cn_CLKDIV < ((900*10⁻⁹ [s] * f_{HFPERCLK} [Hz]) - 5).

Table 3.17. I2C Fast-mode Plus (Fm+)

| Symbol | Parameter | Min | Typ | Max | Unit |
|---------------------|--|------|-----|-------------------|------|
| f _{SCL} | SCL clock frequency | 0 | | 1000 ¹ | kHz |
| t _{LOW} | SCL clock low time | 0.5 | | | μs |
| t _{HIGH} | SCL clock high time | 0.26 | | | μs |
| t _{SU,DAT} | SDA set-up time | 50 | | | ns |
| t _{HD,DAT} | SDA hold time | 8 | | | ns |
| t _{SU,STA} | Repeated START condition set-up time | 0.26 | | | μs |
| t _{HD,STA} | (Repeated) START condition hold time | 0.26 | | | μs |
| t _{SU,STO} | STOP condition set-up time | 0.26 | | | μs |
| t _{BUF} | Bus free time between a STOP and START condition | 0.5 | | | μs |

¹For the minimum HFPERCLK frequency required in Fast-mode Plus, see the I2C chapter in the EFM32ZG Reference Manual.

3.13 Digital Peripherals

Table 3.18. Digital Peripherals

| Symbol | Parameter | Condition | Min | Typ | Max | Unit |
|--------------------|---------------|-------------------------------------|-----|------|-----|------------|
| I _{USART} | USART current | USART idle current, clock enabled | | 7.5 | | μA/ MHz |
| I _{I2C} | I2C current | I2C idle current, clock enabled | | 6.25 | | μA/ MHz |
| I _{TIMER} | TIMER current | TIMER_0 idle current, clock enabled | | 8.75 | | μA/ MHz |
| I _{PCNT} | PCNT current | PCNT idle current, clock enabled | | 100 | | nA |
| I _{RTC} | RTC current | RTC idle current, clock enabled | | 100 | | nA |
| I _{GPIO} | GPIO current | GPIO idle current, clock enabled | | 5.31 | | μA/ MHz |

| Symbol | Parameter | Condition | Min | Typ | Max | Unit |
|------------------|-------------|------------------|-----|------|-----|------------|
| I _{PRS} | PRS current | PRS idle current | | 2,81 | | μA/ MHz |

4 Pinout and Package

Note

Please refer to the application note "AN0002 EFM32 Hardware Design Considerations" for guidelines on designing Printed Circuit Boards (PCB's) for the EFM32ZG108.

4.1 Pinout

The *EFM32ZG108* pinout is shown in Figure 4.1 (p. 34) and Table 4.1 (p. 34). Alternate locations are denoted by "#" followed by the location number (Multiple locations on the same pin are split with "/"). Alternate locations can be configured in the LOCATION bitfield in the *_ROUTE register in the module in question.

Figure 4.1. EFM32ZG108 Pinout (top view, not to scale)

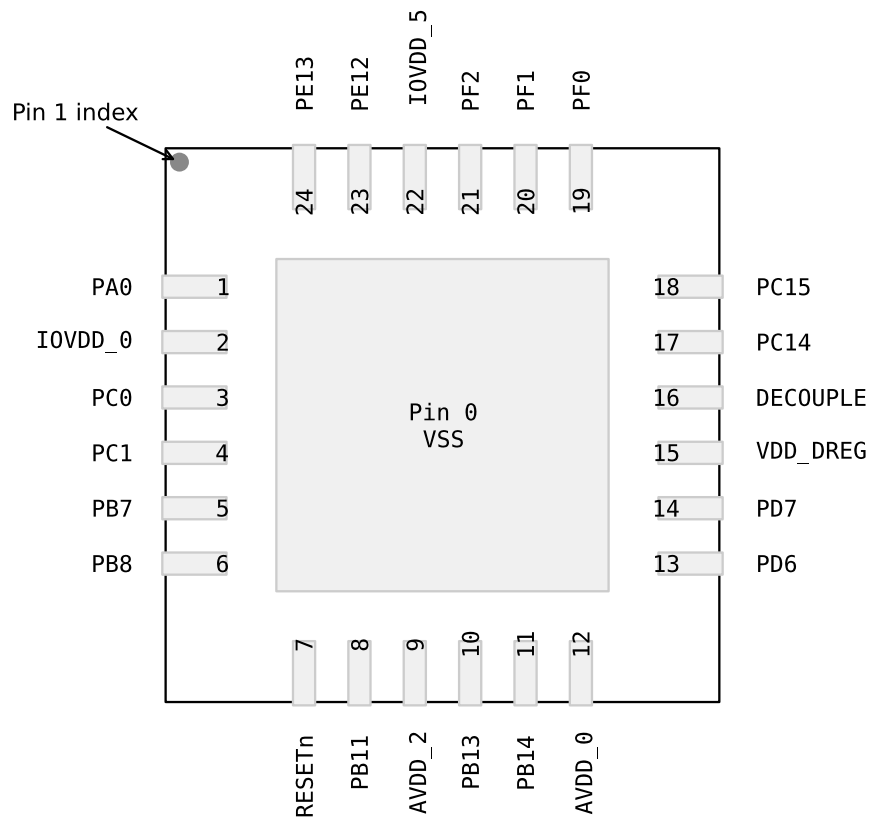

Table 4.1. Device Pinout

| QFN24 Pin# and Name | | Pin Alternate Functionality / Description | | | |
|---------------------|----------|---|--------|---------------|-------|
| Pin # | Pin Name | Analog | Timers | Communication | Other |
| 0 | VSS | Ground | | | |

| QFN24 Pin# and Name | | Pin Alternate Functionality / Description | | | |
|---------------------|----------|--|------------------------------|---|--|
| Pin # | Pin Name | Analog | Timers | Communication | Other |
| 1 | PA0 | | TIM0_CC0 #0/1/4 | LEU0_RX #4 I2C0_SDA #0 | PRS_CH0 #0 GPIO_EM4WU0 |
| 2 | IOVDD_0 | Digital IO power supply 0. | | | |
| 3 | PC0 | ACMP0_CH0 | TIM0_CC1 #4 PCNT0_S0IN #2 | US1_TX #0 I2C0_SDA #4 | PRS_CH2 #0 |
| 4 | PC1 | ACMP0_CH1 | TIM0_CC2 #4 PCNT0_S1IN #2 | US1_RX #0 I2C0_SCL #4 | PRS_CH3 #0 |
| 5 | PB7 | LFXTAL_P | TIM1_CC0 #3 | US1_CLK #0 | |
| 6 | PB8 | LFXTAL_N | TIM1_CC1 #3 | US1_CS #0 | |
| 7 | RESETn | Reset input, active low. To apply an external reset source to this pin, it is required to only drive this pin low during reset, and let the internal pull-up ensure that reset is released. | | | |
| 8 | PB11 | | TIM1_CC2 #3 | | |
| 9 | AVDD_2 | Analog power supply 2. | | | |
| 10 | PB13 | HFXTAL_P | | LEU0_TX #1 | |
| 11 | PB14 | HFXTAL_N | | LEU0_RX #1 | |
| 12 | AVDD_0 | Analog power supply 0. | | | |
| 13 | PD6 | | TIM1_CC0 #4 PCNT0_S0IN #3 | US1_RX #2/3 I2C0_SDA #1 | ACMP0_O #2 |
| 14 | PD7 | | TIM1_CC1 #4 PCNT0_S1IN #3 | US1_TX #2/3 I2C0_SCL #1 | CMU_CLK0 #2 |
| 15 | VDD_DREG | Power supply for on-chip voltage regulator. | | | |
| 16 | DECOUPLE | Decouple output for on-chip voltage regulator. An external capacitance of size C _{DECOUPLE} is required at this pin. | | | |
| 17 | PC14 | | TIM1_CC1 #0 PCNT0_S1IN #0 | US1_CS #3 | PRS_CH0 #2 |
| 18 | PC15 | | TIM1_CC2 #0 | US1_CLK #3 | PRS_CH1 #2 |
| 19 | PF0 | | TIM0_CC0 #5 | US1_CLK #2 LEU0_TX #3 I2C0_SDA #5 | DBG_SWCLK #0 BOOT_TX |
| 20 | PF1 | | TIM0_CC1 #5 | US1_CS #2 LEU0_RX #3 I2C0_SCL #5 | DBG_SWDIO #0 GPIO_EM4WU3 BOOT_RX |
| 21 | PF2 | | TIM0_CC2 #5 | LEU0_TX #4 | GPIO_EM4WU4 |
| 22 | IOVDD_5 | Digital IO power supply 5. | | | |
| 23 | PE12 | | TIM1_CC2 #1 | I2C0_SDA #6 | CMU_CLK1 #2 |
| 24 | PE13 | | | I2C0_SCL #6 | ACMP0_O #0 GPIO_EM4WU5 |

4.2 Alternate Functionality Pinout

A wide selection of alternate functionality is available for multiplexing to various pins. This is shown in Table 4.2 (p. 36). The table shows the name of the alternate functionality in the first column, followed by columns showing the possible LOCATION bitfield settings.

Note

Some functionality, such as analog interfaces, do not have alternate settings or a LOCATION bitfield. In these cases, the pinout is shown in the column corresponding to LOCATION 0.

Table 4.2. Alternate functionality overview

| Alternate | LOCATION | | | | | | | Description |
|-------------|----------|------|------|------|-----|-----|------|---|
| | 0 | 1 | 2 | 3 | 4 | 5 | 6 | |
| ACMP0_CH0 | PC0 | | | | | | | Analog comparator ACMP0, channel 0. |
| ACMP0_CH1 | PC1 | | | | | | | Analog comparator ACMP0, channel 1. |
| ACMP0_O | PE13 | | PD6 | | | | | Analog comparator ACMP0, digital output. |
| BOOT_RX | PF1 | | | | | | | Bootloader RX |
| BOOT_TX | PF0 | | | | | | | Bootloader TX |
| CMU_CLK0 | | | PD7 | | | | | Clock Management Unit, clock output number 0. |
| CMU_CLK1 | | | PE12 | | | | | Clock Management Unit, clock output number 1. |
| DBG_SWCLK | PF0 | | | | | | | Debug-interface Serial Wire clock input. Note that this function is enabled to pin out of reset, and has a built-in pull down. |
| DBG_SWDIO | PF1 | | | | | | | Debug-interface Serial Wire data input / output. Note that this function is enabled to pin out of reset, and has a built-in pull up. |
| GPIO_EM4WU0 | PA0 | | | | | | | Pin can be used to wake the system up from EM4 |
| GPIO_EM4WU3 | PF1 | | | | | | | Pin can be used to wake the system up from EM4 |
| GPIO_EM4WU4 | PF2 | | | | | | | Pin can be used to wake the system up from EM4 |
| GPIO_EM4WU5 | PE13 | | | | | | | Pin can be used to wake the system up from EM4 |
| HFXTAL_N | PB14 | | | | | | | High Frequency Crystal negative pin. Also used as external optional clock input pin. |
| HFXTAL_P | PB13 | | | | | | | High Frequency Crystal positive pin. |
| I2C0_SCL | | PD7 | | | PC1 | PF1 | PE13 | I2C0 Serial Clock Line input / output. |
| I2C0_SDA | PA0 | PD6 | | | PC0 | PF0 | PE12 | I2C0 Serial Data input / output. |
| LEU0_RX | | PB14 | | PF1 | PA0 | | | LEUART0 Receive input. |
| LEU0_TX | | PB13 | | PF0 | PF2 | | | LEUART0 Transmit output. Also used as receive input in half duplex communication. |
| LFXTAL_N | PB8 | | | | | | | Low Frequency Crystal (typically 32.768 kHz) negative pin. Also used as an optional external clock input pin. |
| LFXTAL_P | PB7 | | | | | | | Low Frequency Crystal (typically 32.768 kHz) positive pin. |
| PCNT0_S0IN | | | PC0 | PD6 | | | | Pulse Counter PCNT0 input number 0. |
| PCNT0_S1IN | PC14 | | PC1 | PD7 | | | | Pulse Counter PCNT0 input number 1. |
| PRS_CH0 | PA0 | | PC14 | | | | | Peripheral Reflex System PRS, channel 0. |
| PRS_CH1 | | | PC15 | | | | | Peripheral Reflex System PRS, channel 1. |
| PRS_CH2 | PC0 | | | | | | | Peripheral Reflex System PRS, channel 2. |
| PRS_CH3 | PC1 | | | | | | | Peripheral Reflex System PRS, channel 3. |
| TIM0_CC0 | PA0 | PA0 | | | PA0 | PF0 | | Timer 0 Capture Compare input / output channel 0. |
| TIM0_CC1 | | | | | PC0 | PF1 | | Timer 0 Capture Compare input / output channel 1. |
| TIM0_CC2 | | | | | PC1 | PF2 | | Timer 0 Capture Compare input / output channel 2. |
| TIM1_CC0 | | | | PB7 | PD6 | | | Timer 1 Capture Compare input / output channel 0. |
| TIM1_CC1 | PC14 | | | PB8 | PD7 | | | Timer 1 Capture Compare input / output channel 1. |
| TIM1_CC2 | PC15 | PE12 | | PB11 | | | | Timer 1 Capture Compare input / output channel 2. |
| US1_CLK | PB7 | | PF0 | PC15 | | | | USART1 clock input / output. |
| US1_CS | PB8 | | PF1 | PC14 | | | | USART1 chip select input / output. |
| US1_RX | PC1 | | PD6 | PD6 | | | | USART1 Asynchronous Receive. |

| Alternate | LOCATION | | | | | | | Description |
|---------------|----------|---|-----|-----|---|---|---|---|
| Functionality | 0 | 1 | 2 | 3 | 4 | 5 | 6 | |
| | | | | | | | | USART1 Synchronous mode Master Input / Slave Output (MISO). |
| US1_TX | PC0 | | PD7 | PD7 | | | | USART1 Asynchronous Transmit. Also used as receive input in half duplex communication. USART1 Synchronous mode Master Output / Slave Input (MOSI). |

4.3 GPIO Pinout Overview

The specific GPIO pins available in *EFM32ZG108* is shown in Table 4.3 (p. 37). Each GPIO port is organized as 16-bit ports indicated by letters A through F, and the individual pin on this port is indicated by a number from 15 down to 0.

Table 4.3. GPIO Pinout

| Port | Pin 15 | Pin 14 | Pin 13 | Pin 12 | Pin 11 | Pin 10 | Pin 9 | Pin 8 | Pin 7 | Pin 6 | Pin 5 | Pin 4 | Pin 3 | Pin 2 | Pin 1 | Pin 0 |
|--------|--------|--------|--------|--------|--------|--------|-------|-------|-------|-------|-------|-------|-------|-------|-------|-------|
| Port A | - | - | - | - | - | - | - | - | - | - | - | - | - | - | - | PA0 |
| Port B | - | PB14 | PB13 | - | PB11 | - | - | PB8 | PB7 | - | - | - | - | - | - | - |
| Port C | PC15 | PC14 | - | - | - | - | - | - | - | - | - | - | - | - | PC1 | PC0 |
| Port D | - | - | - | - | - | - | - | - | PD7 | PD6 | - | - | - | - | - | - |
| Port E | - | - | PE13 | PE12 | - | - | - | - | - | - | - | - | - | - | - | - |
| Port F | - | - | - | - | - | - | - | - | - | - | - | - | - | PF2 | PF1 | PF0 |

4.4 QFN24 Package

Figure 4.2. QFN24 (Preliminary)

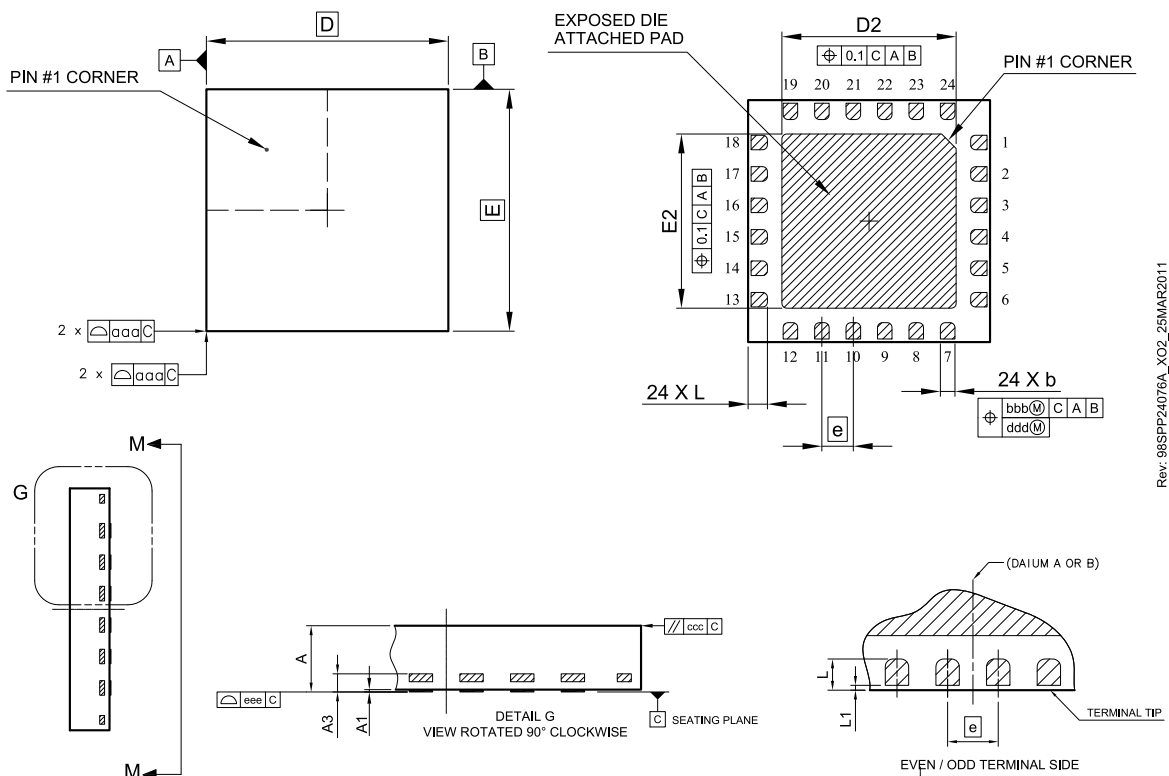

Rev: 98SFP24076A_XO2_25MAR2011

Note:

1. Dimensioning & tolerancing confirm to ASME Y14.5M-1994.
2. All dimensions are in millimeters. Angles are in degrees.
3. Dimension 'b' applies to metallized terminal and is measured between 0.25 mm and 0.30 mm from the terminal tip. Dimension L1 represents terminal full back from package edge up to 0.1 mm is acceptable.
4. Coplanarity applies to the exposed heat slug as well as the terminal.
5. Radius on terminal is optional

Table 4.4. QFN24 (Preliminary) (Dimensions in mm)

| Symbol | A | A1 | A3 | b | D | E | D2 | E2 | e | L | L1 | aaa | bbb | ccc | ddd | eee |
|--------|------|------|--------------|------|-------------|-------------|------|------|-------------|------|------|------|------|------|------|------|
| Min | 0.80 | 0.00 | 0.203 REF | 0.25 | 5.00 BSC | 5.00 BSC | 3.50 | 3.50 | 0.65 BSC | 0.35 | 0.00 | 0.10 | 0.10 | 0.10 | 0.05 | 0.08 |
| Nom | 0.85 | - | | 0.30 | | | 3.60 | 3.60 | | 0.40 | | | | | | |
| Max | 0.90 | 0.05 | | 0.35 | | | 3.70 | 3.70 | | 0.46 | 0.10 | | | | | |

The QFN24 Package uses Nickel-Palladium-Gold preplated leadframe.

All EFM32 packages are RoHS compliant and free of Bromine (Br) and Antimony (Sb).

5 PCB Layout and Soldering

5.1 Recommended PCB Layout

Figure 5.1. QFN24 PCB Land Pattern

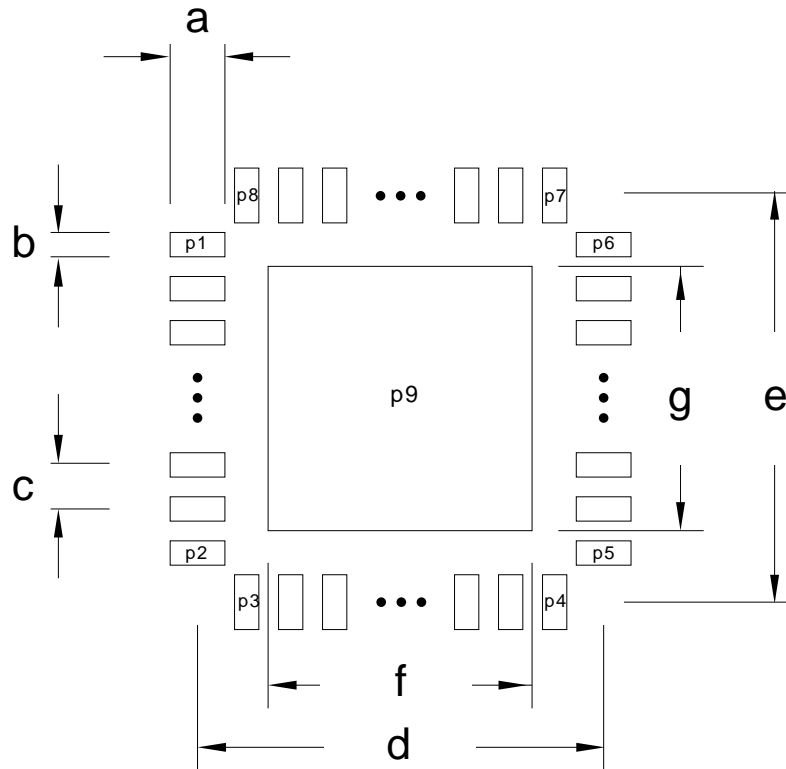

Table 5.1. QFN24 PCB Land Pattern Dimensions (Dimensions in mm)

| Symbol | Dim. (mm) | Symbol | Pin number | Symbol | Pin number |
|--------|-----------|--------|------------|--------|------------|
| a | 0.80 | P1 | 1 | P8 | 24 |
| b | 0.30 | P2 | 6 | P9 | 25 |
| c | 0.65 | P3 | 7 | - | - |
| d | 5.00 | P4 | 12 | - | - |
| e | 5.00 | P5 | 13 | - | - |
| f | 3.60 | P6 | 18 | - | - |
| g | 3.60 | P7 | 19 | - | - |

Figure 5.2. QFN24 PCB Solder Mask

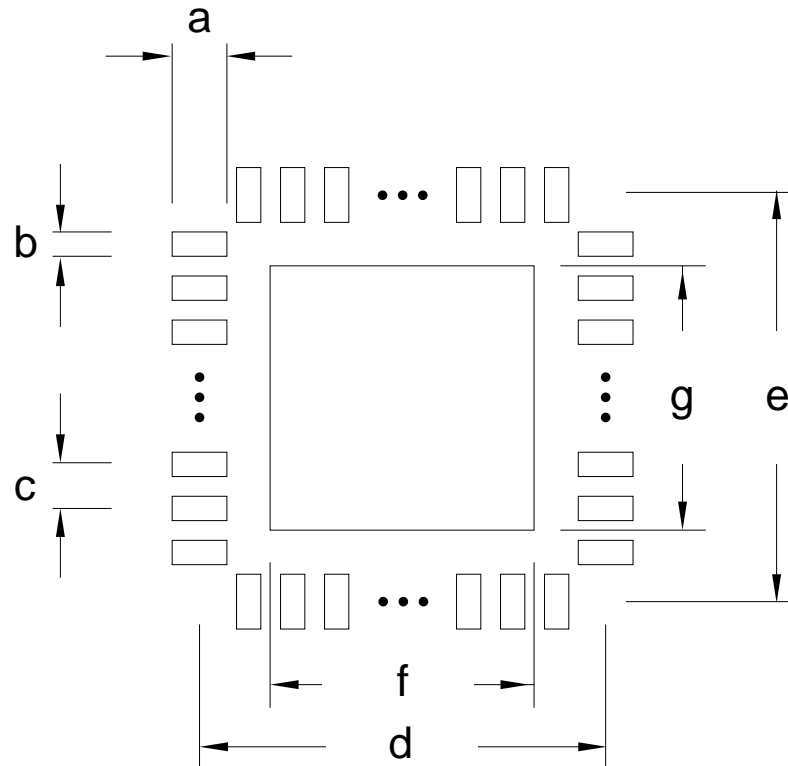

Table 5.2. QFN24 PCB Solder Mask Dimensions (Dimensions in mm)

| Symbol | Dim. (mm) | Symbol | Dim. (mm) |
|--------|-----------|--------|-----------|
| a | 0.92 | e | 5.00 |
| b | 0.42 | f | 3.72 |
| c | 0.65 | g | 3.72 |
| d | 5.00 | - | - |

Figure 5.3. QFN24 PCB Stencil Design

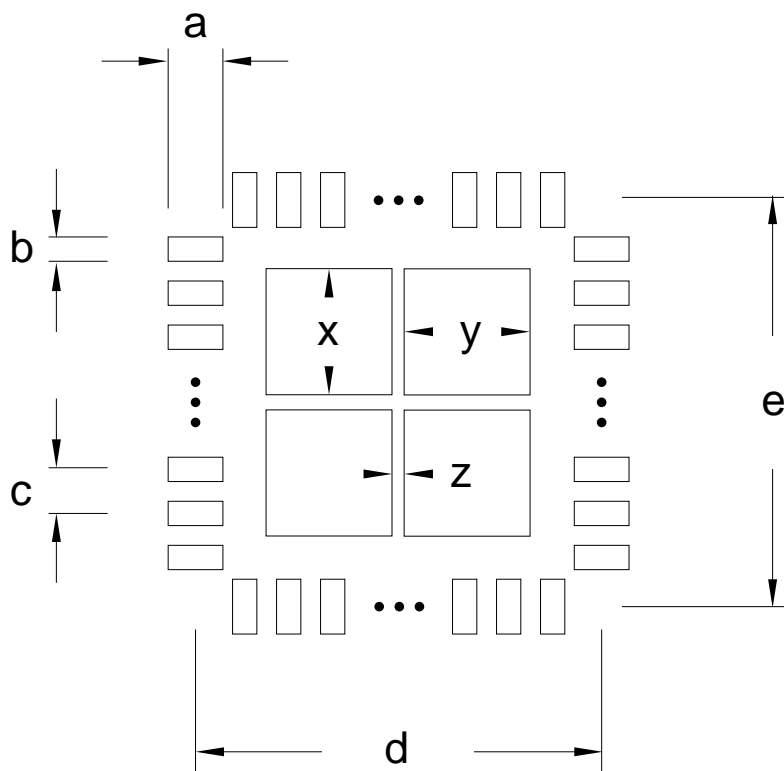

Table 5.3. QFN24 PCB Stencil Design Dimensions (Dimensions in mm)

| Symbol | Dim. (mm) | Symbol | Dim. (mm) |
|--------|-----------|--------|-----------|
| a | 0.60 | e | 5.00 |
| b | 0.25 | x | 1.00 |
| c | 0.65 | y | 1.00 |
| d | 5.00 | z | 0.50 |

1. The drawings are not to scale.
2. All dimensions are in millimeters.
3. All drawings are subject to change without notice.
4. The PCB Land Pattern drawing is in compliance with IPC-7351B.
5. Stencil thickness 0.125 mm.
6. For detailed pin-positioning, see Figure 4.2 (p. 37) .

5.2 Soldering Information

The latest IPC/JEDEC J-STD-020 recommendations for Pb-Free reflow soldering should be followed.

The packages have a Moisture Sensitivity Level rating of 3, please see the latest IPC/JEDEC J-STD-033 standard for MSL description and level 3 bake conditions. Place as many and as small as possible vias underneath each of the solder patches under the ground pad.

6 Chip Marking, Revision and Errata

6.1 Chip Marking

In the illustration below package fields and position are shown.

Figure 6.1. Example Chip Marking

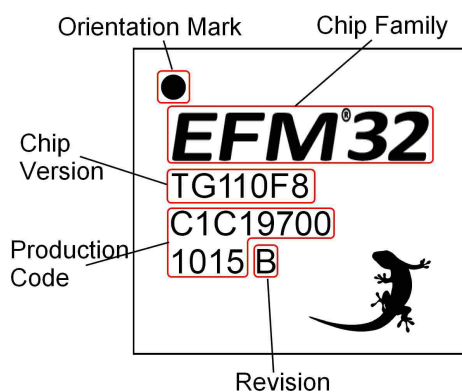

6.2 Revision

The revision of a chip can be determined from the "Revision" field in Figure 6.1 (p. 42). If the revision says "ES" (Engineering Sample), the revision must be read out electronically as specified in the reference manual.

6.3 Errata

No known errata for EFM32ZG108.

7 Revision History

7.1 Revision 0.60

October 9th, 2013

Added I2C characterization data.

Added IDAC characterization data.

Updated current consumption table and figures in Electrical characteristics section.

Removed Environmental information.

Updated trademark, disclaimer and contact information.

Other minor corrections.

7.2 Revision 0.50

April 22nd, 2013

Updated HFCORE max frequency from 32 MHz to 24 MHz.

Updated pinout.

Other minor corrections.

7.3 Revision 0.40

September 11th, 2012

Updated CPU core from Cortex M0 to Cortex M0+.

Updated the HFRCO 1 MHz band typical value to 1.2 MHz.

Updated the HFRCO 7 MHz band typical value to 6.6 MHz.

Corrected operating voltage from 1.8 V to 1.85 V.

Other minor corrections.

7.4 Revision 0.30

July 16th, 2011

Updated the Electrical Characteristics section.

7.5 Revision 0.20

June 8th, 2011

Corrected all current values in Electrical Characteristics section.

Updated Cortex M0 related items in the memory map.

7.6 Revision 0.10

June 7th, 2011

Initial preliminary release.

A Disclaimer and Trademarks

A.1 Disclaimer

Silicon Laboratories intends to provide customers with the latest, accurate, and in-depth documentation of all peripherals and modules available for system and software implementers using or intending to use the Silicon Laboratories products. Characterization data, available modules and peripherals, memory sizes and memory addresses refer to each specific device, and "Typical" parameters provided can and do vary in different applications. Application examples described herein are for illustrative purposes only. Silicon Laboratories reserves the right to make changes without further notice and limitation to product information, specifications, and descriptions herein, and does not give warranties as to the accuracy or completeness of the included information. Silicon Laboratories shall have no liability for the consequences of use of the information supplied herein. This document does not imply or express copyright licenses granted hereunder to design or fabricate any integrated circuits. The products must not be used within any Life Support System without the specific written consent of Silicon Laboratories. A "Life Support System" is any product or system intended to support or sustain life and/or health, which, if it fails, can be reasonably expected to result in significant personal injury or death. Silicon Laboratories products are generally not intended for military applications. Silicon Laboratories products shall under no circumstances be used in weapons of mass destruction including (but not limited to) nuclear, biological or chemical weapons, or missiles capable of delivering such weapons.

A.2 Trademark Information

Silicon Laboratories Inc., Silicon Laboratories, Silicon Labs, SiLabs and the Silicon Labs logo, CMEMS[®], EFM, EFM32, EFR, Energy Micro, Energy Micro logo and combinations thereof, "the world's most energy friendly microcontrollers", Ember[®], EZLink[®], EZMac[®], EZRadio[®], EZRadioPRO[®], DSPLL[®], ISO-modem[®], Precision32[®], ProSLIC[®], SiPHY[®], USBXpress[®] and others are trademarks or registered trademarks of Silicon Laboratories Inc. ARM, CORTEX, Cortex-M3 and THUMB are trademarks or registered trademarks of ARM Holdings. Keil is a registered trademark of ARM Limited. All other products or brand names mentioned herein are trademarks of their respective holders.

B Contact Information

Silicon Laboratories Inc.

400 West Cesar Chavez

Austin, TX 78701

Please visit the Silicon Labs Technical Support web page:

<http://www.silabs.com/support/pages/contacttechnicalsupport.aspx>

and register to submit a technical support request.

Table of Contents

| | |
|--|----|
| 1. Ordering Information | 2 |
| 2. System Summary | 3 |
| 2.1. System Introduction | 3 |
| 2.2. Configuration Summary | 6 |
| 2.3. Memory Map | 6 |
| 3. Electrical Characteristics | 8 |
| 3.1. Test Conditions | 8 |
| 3.2. Absolute Maximum Ratings | 8 |
| 3.3. General Operating Conditions | 8 |
| 3.4. Current Consumption | 9 |
| 3.5. Transition between Energy Modes | 16 |
| 3.6. Power Management | 16 |
| 3.7. Flash | 17 |
| 3.8. General Purpose Input Output | 18 |
| 3.9. Oscillators | 25 |
| 3.10. Analog Comparator (ACMP) | 29 |
| 3.11. Voltage Comparator (VCMP) | 31 |
| 3.12. I2C | 31 |
| 3.13. Digital Peripherals | 32 |
| 4. Pinout and Package | 34 |
| 4.1. Pinout | 34 |
| 4.2. Alternate Functionality Pinout | 35 |
| 4.3. GPIO Pinout Overview | 37 |
| 4.4. QFN24 Package | 37 |
| 5. PCB Layout and Soldering | 39 |
| 5.1. Recommended PCB Layout | 39 |
| 5.2. Soldering Information | 41 |
| 6. Chip Marking, Revision and Errata | 42 |
| 6.1. Chip Marking | 42 |
| 6.2. Revision | 42 |
| 6.3. Errata | 42 |
| 7. Revision History | 43 |
| 7.1. Revision 0.60 | 43 |
| 7.2. Revision 0.50 | 43 |
| 7.3. Revision 0.40 | 43 |
| 7.4. Revision 0.30 | 43 |
| 7.5. Revision 0.20 | 43 |
| 7.6. Revision 0.10 | 43 |
| A. Disclaimer and Trademarks | 45 |
| A.1. Disclaimer | 45 |
| A.2. Trademark Information | 45 |
| B. Contact Information | 46 |
| B.1. | 46 |

List of Figures

| | |
|---|----|
| 2.1. Block Diagram | 3 |
| 2.2. EFM32ZG108 Memory Map with largest RAM and Flash sizes | 7 |
| 3.1. EM0 Current consumption while executing prime number calculation code from flash with HFRCO running at 24MHz | 10 |
| 3.2. EM0 Current consumption while executing prime number calculation code from flash with HFRCO running at 21MHz | 10 |
| 3.3. EM0 Current consumption while executing prime number calculation code from flash with HFRCO running at 14MHz | 11 |
| 3.4. EM0 Current consumption while executing prime number calculation code from flash with HFRCO running at 11MHz | 11 |
| 3.5. | 12 |
| 3.6. EM1 Current consumption with all peripheral clocks disabled and HFRCO running at 24MHz | 12 |
| 3.7. EM1 Current consumption with all peripheral clocks disabled and HFRCO running at 21MHz | 13 |
| 3.8. EM1 Current consumption with all peripheral clocks disabled and HFRCO running at 14MHz | 13 |
| 3.9. EM1 Current consumption with all peripheral clocks disabled and HFRCO running at 11MHz | 14 |
| 3.10. | 14 |
| 3.11. EM2 current consumption. RTC prescaled to 1kHz, 32.768 kHz LFRCO. | 15 |
| 3.12. EM3 current consumption. | 15 |
| 3.13. EM4 current consumption. | 16 |
| 3.14. Typical Low-Level Output Current, 2V Supply Voltage | 19 |
| 3.15. Typical High-Level Output Current, 2V Supply Voltage | 20 |
| 3.16. Typical Low-Level Output Current, 3V Supply Voltage | 21 |
| 3.17. Typical High-Level Output Current, 3V Supply Voltage | 22 |
| 3.18. Typical Low-Level Output Current, 3.8V Supply Voltage | 23 |
| 3.19. Typical High-Level Output Current, 3.8V Supply Voltage | 24 |
| 3.20. Calibrated LFRCO Frequency vs Temperature and Supply Voltage | 26 |
| 3.21. Calibrated HFRCO 11 MHz Band Frequency vs Supply Voltage and Temperature | 27 |
| 3.22. Calibrated HFRCO 14 MHz Band Frequency vs Supply Voltage and Temperature | 28 |
| 3.23. Calibrated HFRCO 21 MHz Band Frequency vs Supply Voltage and Temperature | 28 |
| 3.24. ACMP Characteristics, Vdd = 3V, Temp = 25°C, FULLBIAS = 0, HALFBIAS = 1 | 30 |
| 4.1. EFM32ZG108 Pinout (top view, not to scale) | 34 |
| 4.2. QFN24 (Preliminary) | 37 |
| 5.1. QFN24 PCB Land Pattern | 39 |
| 5.2. QFN24 PCB Solder Mask | 40 |
| 5.3. QFN24 PCB Stencil Design | 41 |
| 6.1. Example Chip Marking | 42 |

List of Tables

| | |
|---|----|
| 1.1. Ordering Information | 2 |
| 2.1. Configuration Summary | 6 |
| 3.1. Absolute Maximum Ratings | 8 |
| 3.2. General Operating Conditions | 8 |
| 3.3. Current Consumption | 9 |
| 3.4. Energy Modes Transitions | 16 |
| 3.5. Power Management | 17 |
| 3.6. Flash | 17 |
| 3.7. GPIO | 18 |
| 3.8. LFXO | 25 |
| 3.9. HFXO | 25 |
| 3.10. LFRCO | 26 |
| 3.11. HFRCO | 27 |
| 3.12. ULFRCO | 28 |
| 3.13. ACMP | 29 |
| 3.14. VCMP | 31 |
| 3.15. I2C Standard-mode (Sm) | 31 |
| 3.16. I2C Fast-mode (Fm) | 32 |
| 3.17. I2C Fast-mode Plus (Fm+) | 32 |
| 3.18. Digital Peripherals | 32 |
| 4.1. Device Pinout | 34 |
| 4.2. Alternate functionality overview | 36 |
| 4.3. GPIO Pinout | 37 |
| 4.4. QFN24 (Preliminary) (Dimensions in mm) | 38 |
| 5.1. QFN24 PCB Land Pattern Dimensions (Dimensions in mm) | 39 |
| 5.2. QFN24 PCB Solder Mask Dimensions (Dimensions in mm) | 40 |
| 5.3. QFN24 PCB Stencil Design Dimensions (Dimensions in mm) | 41 |

List of Equations

| | |
|--|----|
| 3.1. Total ACMP Active Current | 29 |
| 3.2. VCMP Trigger Level as a Function of Level Setting | 31 |

silabs.com

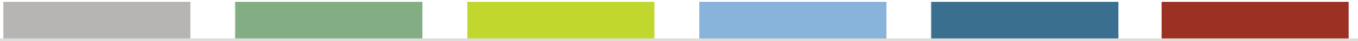

ZERO
ARM Cortex-M0+

TINY
ARM Cortex-M3

GECKO
ARM Cortex-M3

LEOPARD
ARM Cortex-M3

GIANT
ARM Cortex-M3

WONDER
ARM Cortex-M4



**Стандарт
Электрон
Связь**

Мы молодая и активно развивающаяся компания в области поставок электронных компонентов. Мы поставляем электронные компоненты отечественного и импортного производства напрямую от производителей и с крупнейших складов мира.

Благодаря сотрудничеству с мировыми поставщиками мы осуществляем комплексные и плановые поставки широчайшего спектра электронных компонентов.

Собственная эффективная логистика и склад в обеспечивает надежную поставку продукции в точно указанные сроки по всей России.

Мы осуществляем техническую поддержку нашим клиентам и предпродажную проверку качества продукции. На все поставляемые продукты мы предоставляем гарантию .

Осуществляем поставки продукции под контролем ВП МО РФ на предприятия военно-промышленного комплекса России , а также работаем в рамках 275 ФЗ с открытием отдельных счетов в уполномоченном банке. Система менеджмента качества компании соответствует требованиям ГОСТ ISO 9001.

Минимальные сроки поставки, гибкие цены, неограниченный ассортимент и индивидуальный подход к клиентам являются основой для выстраивания долгосрочного и эффективного сотрудничества с предприятиями радиоэлектронной промышленности, предприятиями ВПК и научно-исследовательскими институтами России.

С нами вы становитесь еще успешнее!

Наши контакты:

Телефон: +7 812 627 14 35

Электронная почта: sales@st-electron.ru

Адрес: 198099, Санкт-Петербург,
Промышленная ул, дом № 19, литера Н,
помещение 100-Н Офис 331