

## Phototriac coupler ideal for triac driver with wide variation

## APT Phototriac Coupler

### FEATURES

**1. Low zero-cross voltage (max. 15 V) type added to lineup. Approximately 1/3 of previous product**  
Helps reduce device noises even further.

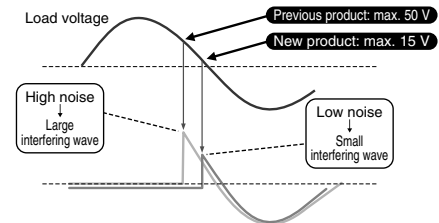

- 2. Two types available: Random type and zero-cross type**
- 3. Many package sizes available. (Wide terminal type with 10.16 mm pitch between I/O terminals available.)**
- 4. High dielectric strength. (Between input and output: SOP 3, 750 V; DIP 5,000 V)**
- 5. Handles both 100 and 200 V AC loads**

This relay handles both voltages in a single product it is not necessary for users that use both types to manage separate part numbers.

**6. Terminal 5 of the DIP 6-pin type is completely molded.**

### TYPICAL APPLICATIONS

- 1. For triac driver in heater controls of products such as office equipment, home appliances, and industrial machines. (For 100V/200V, 50/60 Hz lines)**
- 2. Triac driver for SSRs**

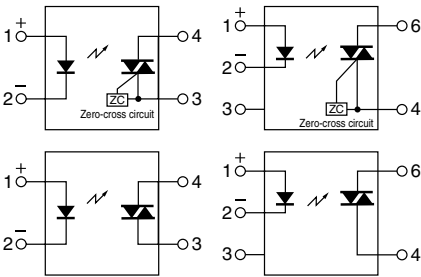
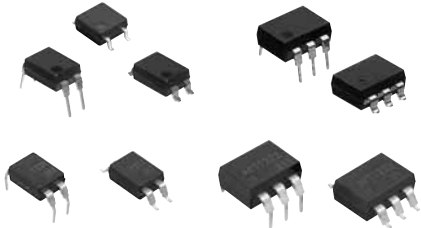

RoHS compliant

### TYPES

#### 1. SOP4 Type

Type	Output rating		Type	Package size	Part No.			Packing quantity	
	Repetitive peak OFF-state voltage	ON-state RMS current			Tube packing style	Tape and reel packing style		Tube	Tape and reel
AC type	600 V	50 mA	Zero-cross (max. 50 V)	SOP4pin	APT1211S	APT1211SX (Picked from the 1/2-pin side)	APT1211SZ (Picked from the 3/4-pin side)	1 tube contains: 100 pcs. 1 batch contains: 2,000 pcs.	1,000 pcs.
			Zero-cross (max. 15 V)		APT1231S	APT1231SX (Picked from the 1/2-pin side)	APT1231SZ (Picked from the 3/4-pin side)		
			Random		APT1221S	APT1221SX (Picked from the 1/2-pin side)	APT1221SZ (Picked from the 3/4-pin side)		

Note: For space reasons, the initial letters of the product number "APT" and "S" are omitted on the product seal. The package type indicator "X" and "Z" are omitted from the seal. (Ex. the label for product number APT1221SZ is 1221).

2. DIP4/6 Type

Type	Output rating		Type	Package size	Part No.				Packing quantity	
	Repetitive peak OFF-state voltage	ON-state RMS current			Through hole terminal	Surface-mount terminal		Tube	Tape and reel	
					Tube packing style		Tape and reel packing style			
AC type	600 V	100 mA	Zero-cross (max. 50 V)	DIP4pin	APT1211	APT1211A	APT1211AX (Picked from the 1/2-pin side)	APT1211AZ (Picked from the 3/4-pin side)	[DIP4pin] 1 tube contains: 100 pcs. 1 batch contains: 1,000 pcs.	[DIP4pin] [DIP6pin] 1,000 pcs.
			Zero-cross (max. 15 V)		APT1231	APT1231A	APT1231AX (Picked from the 1/2-pin side)	APT1231AZ (Picked from the 3/4-pin side)		
			Random		APT1221	APT1221A	APT1221AX (Picked from the 1/2-pin side)	APT1221AZ (Picked from the 3/4-pin side)		
			Zero-cross (max. 50 V)	DIP6pin	APT1212	APT1212A	APT1212AX (Picked from the 1/2/3-pin side)	APT1212AZ (Picked from the 4/6-pin side)		
			Zero-cross (max. 15 V)		APT1232	APT1232A	APT1232AX (Picked from the 1/2/3-pin side)	APT1232AZ (Picked from the 4/6-pin side)		
			Random		APT1222	APT1222A	APT1222AX (Picked from the 1/2/3-pin side)	APT1222AZ (Picked from the 4/6-pin side)		

Note: For space reasons the initial letters "APT" of the product number for the DIP 4-pin type, the letter "A", which indicates the SMD terminal shape for the DIP 4-pin and 6-pin types, and the package type indications "X" and "Z" have been omitted from the product label. (Example: The label for product number APT1221AZ is 1221.)

3. DIP4/6 Wide Terminal Type

Type	Output rating*		Type	Package size	Part No.				Packing quantity	
	Repetitive peak OFF-state voltage	ON-state RMS current			Through hole terminal	Surface-mount terminal		Tube	Tape and reel	
					Tube packing style		Tape and reel packing style			
AC type	600 V	100 mA	Zero-cross (max. 50 V)	DIP4pin	APT1211W	APT1211WA	APT1211WAY (Picked from the 1/4-pin side)	APT1211WAW (Picked from the 2/3-pin side)	[DIP4pin] 1 tube contains: 100 pcs. 1 batch contains: 1,000 pcs.	[DIP4pin] [DIP6pin] 1,000 pcs.
			Zero-cross (max. 15 V)		APT1231W	APT1231WA	APT1231WAY (Picked from the 1/4-pin side)	APT1231WAW (Picked from the 2/3-pin side)		
			Random		APT1221W	APT1221WA	APT1221WAY (Picked from the 1/4-pin side)	APT1221WAW (Picked from the 2/3-pin side)		
			Zero-cross (max. 50 V)	DIP6pin	APT1212W	APT1212WA	APT1212WAY (Picked from the 1/6-pin side)	APT1212WAW (Picked from the 3/4-pin side)		
			Zero-cross (max. 15 V)		APT1232W	APT1232WA	APT1232WAY (Picked from the 1/6-pin side)	APT1232WAW (Picked from the 3/4-pin side)		
			Random		APT1222W	APT1222WA	APT1222WAY (Picked from the 1/6-pin side)	APT1222WAW (Picked from the 3/4-pin side)		

Note: For space reasons the initial letters "APT" of the product number for the DIP 4-pin type, the letter "WA", which indicates the SMD terminal shape for the DIP 4-pin and 6-pin types, and the package type indications "Y" and "W" have been omitted from the product label. (Example: The label for product number APT1221WAY is 1221.)

RATING

1. Absolute maximum ratings (Ambient temperature: 25°C 77°F)

1) SOP4 types

Item		Symbol	APT1211S, APT1221S, APT1231S	Remarks
Input	LED forward current	I <sub>F</sub>	50 mA	
	LED reverse voltage	V <sub>R</sub>	6 V	
	Peak forward current	I <sub>FP</sub>	1 A	f = 100 Hz, Duty Ratio = 0.1%
Output	Repetitive peak OFF-state voltage	V <sub>DRM</sub>	600 V	
	ON-state RMS current*	I <sub>T(RMS)</sub>	0.05 A	AC
	Non-repetitive surge current	I <sub>TSM</sub>	0.6 A	In one cycle at 60Hz
Total power dissipation		P <sub>T</sub>	350 mW	
I/O isolation voltage		V <sub>iso</sub>	3,750 V AC	
Temperature limits	Operating	T <sub>opr</sub>	-40°C to +100°C -40°F to +212°F	Non-condensing at low temperatures
	Storage	T <sub>stg</sub>	-40°C to +125°C -40°F to +257°F	

Note: "X" and "Z" at the end of the part numbers have been omitted.

# APT1

## 2) DIP4/6 type and DIP4/6 Wide terminal type

Item		Symbol	APT1211(W), APT1221(W), APT1231(W), APT1212(W), APT1222(W), APT1232(W)	Remarks
Input	LED forward current	$I_F$	50 mA	
	LED reverse voltage	$V_R$	6 V	
	Peak forward current	$I_{FP}$	1 A	f = 100 Hz, Duty Ratio = 0.1%
Output	Repetitive peak OFF-state voltage	$V_{DRM}$	600 V	
	ON-state RMS current*	$I_{T(RMS)}$	0.1 A	AC
	Non-repetitive surge current	$I_{TSM}$	1.2 A	In one cycle at 60Hz
Total power dissipation		$P_T$	500 mW	
I/O isolation voltage		$V_{iso}$	5,000 V AC	
Temperature limits	Operating	$T_{opr}$	-40°C to +100°C -40°F to +212°F	Non-condensing at low temperatures
	Storage	$T_{stg}$	-40°C to +125°C -40°F to +257°F	

Note: "A", "AX", "AZ", "AY" and "AW" at the end of the part numbers have been omitted.

\* Do not exceed 0.05 A of ON state RMS current in case of following load voltage condition.

DIP4pin (APT1211, APT1221, APT1231) and DIP4pin wide terminal type (APT1211W, APT1221W, APT1231W): more than 100 V AC;

DIP6pin (APT1212, APT1222, APT1232) and DIP6pin wide terminal type (APT1212W, APT1222W, APT1232W): more than 120 V AC.

## 2. Characteristics (Ambient temperature: 25°C 77°F)

### 1) Zero-cross type (max. 50V) and random type

Item		Symbol	APT1211S, APT1211(W), APT1212(W)	APT1221S, APT1221(W), APT1222(W)	Condition	
Input	LED dropout voltage	Typical	1.21 V		$I_F = 20 \text{ mA}$	
		Maximum	1.3 V			
Input	LED reverse current	Typical	—		$V_R = 6 \text{ V}$	
		Maximum	10 $\mu\text{A}$			
Output	Repetitive peak OFF-state current	Typical	—		$I_F = 0 \text{ mA}$ $V_{DRM} = 600 \text{ V}$	
		Maximum	1 $\mu\text{A}$			
	Repetitive peak On-state voltage	Typical	1.3 V		$I_F = 10 \text{ mA}$ $I_{TM} = 0.05 \text{ A}$	
		Maximum	2.5 V			
	Holding current	Typical	0.3 mA			
		Maximum	3.5 mA			
Critical rate of rise of OFF-state voltage	Minimum	$dv/dt$	500 V/ $\mu\text{s}$		$V_{DRM} = 600 \text{ V} \times 1/\sqrt{2}$	
Transfer characteristics	Trigger LED current	Maximum	$I_{FT}$	10 mA		$V_D = 6 \text{ V}$ $R_L = 100 \Omega$
	Zero-cross voltage	Maximum	$V_{ZC}$	50 V	—	$I_F = 10 \text{ mA}$
	Turn on time*	Maximum	$T_{on}$	100 $\mu\text{s}$		$I_F = 20 \text{ mA}$ $V_D = 6 \text{ V}$ $R_L = 100 \Omega$
	I/O capacitance	Maximum	$C_{iso}$	1.5 pF		f = 1 MHz $V_B = 0 \text{ V}$
	I/O isolation resistance	Minimum	$R_{iso}$	50 G $\Omega$		500 V DC

Notes: 1. For type of connection, see page 41.

2. Terminals are either solder plated or solder dipped.

### \*Turn on time

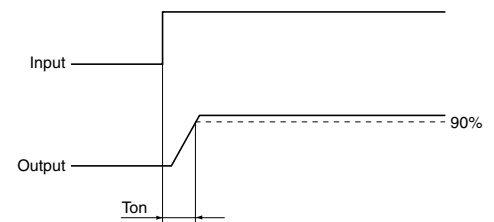

2) Zero-cross type (max. 15V)

Item			Symbol	APT1231S, APT1231(W), APT1232(W)	Condition
Input	LED dropout voltage	Typical	V <sub>F</sub>	1.21 V	I <sub>F</sub> = 20 mA
		Maximum		1.3 V	
	LED reverse current	Typical	I <sub>R</sub>	—	V <sub>R</sub> = 6 V
		Maximum		10 μA	
Output	Repetitive peak OFF-state current	Typical	I <sub>DRM</sub>	—	I <sub>F</sub> = 0 mA V <sub>DRM</sub> = 600 V
		Maximum		1 μA	
	Repetitive peak On-state voltage	Typical	V <sub>TM</sub>	1.2 V	I <sub>F</sub> = 10 mA I <sub>TM</sub> = 0.03 A
		Maximum		2 V	
	Holding current	Typical	I <sub>H</sub>	0.3 mA	
		Maximum		3.5 mA	
Critical rate of rise of OFF-state voltage	Minimum	dv/dt	500 V/μs	V <sub>DRM</sub> = 600 V × 1/√2	
Transfer characteristics	Trigger LED current	Maximum	I <sub>FT</sub>	10 mA	I <sub>TM</sub> = 0.03 A
	Zero-cross voltage	Maximum	V <sub>ZC</sub>	15 V	I <sub>F</sub> = 10 mA
	Turn on time*	Maximum	T <sub>on</sub>	100 μs	I <sub>F</sub> = 20 mA I <sub>TM</sub> = 0.03 A
	I/O capacitance	Maximum	C <sub>iso</sub>	1.5 pF	f = 1 MHz V <sub>B</sub> = 0 V
	I/O isolation resistance	Minimum	R <sub>iso</sub>	50 GΩ	500 V DC

Notes: 1. For type of connection, see page 41.  
2. Terminals are either solder plated or solder dipped.

**\*Turn on time**

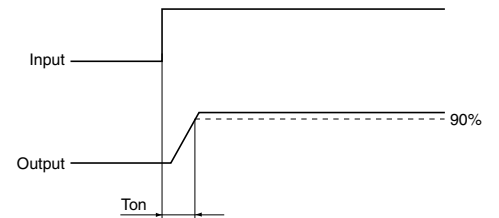

**RECOMMENDED OPERATING CONDITIONS**

Please follow the conditions below in order to ensure accurate operation and release of the phototriac coupler.

Item	Symbol	Value	Unit
Input LED current	I <sub>F</sub>	20	mA

**REFERENCE DATA**

1-(1). ON-state RMS current vs. ambient temperature characteristics

Allowable ambient temperature: -40°C to +100°C  
-40°F to +212°F

Tested sample: APT1211S, APT1221S

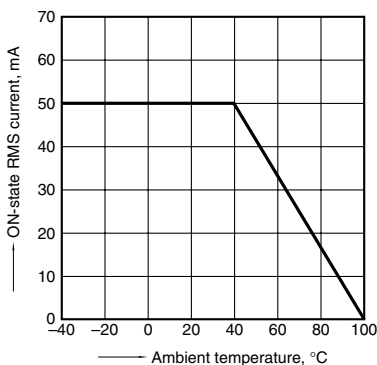

1-(2). ON-state RMS current vs. ambient temperature characteristics

Allowable ambient temperature: -40°C to +100°C  
-40°F to +212°F

Tested sample: APT1231S

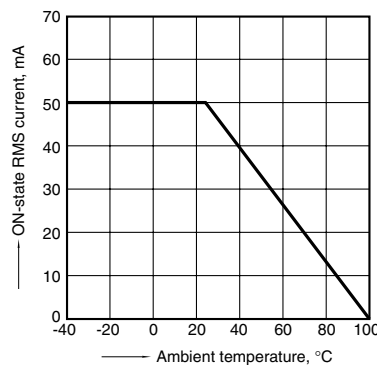

1-(3). ON-state RMS current vs. ambient temperature characteristics

Allowable ambient temperature: -40°C to +100°C  
-40°F to +212°F

Tested sample: APT1211(A), APT1221(A),  
APT1211W(A), APT1221W(A)

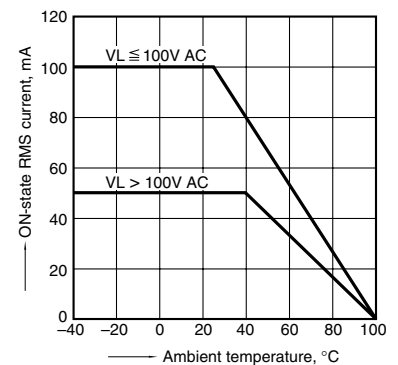

# APT1

## 1-(4). ON-state RMS current vs. ambient temperature characteristics

Allowable ambient temperature:  $-40^{\circ}\text{C}$  to  $+100^{\circ}\text{C}$   
 $-40^{\circ}\text{F}$  to  $+212^{\circ}\text{F}$

Tested sample: APT1231(A), APT1231W(A)

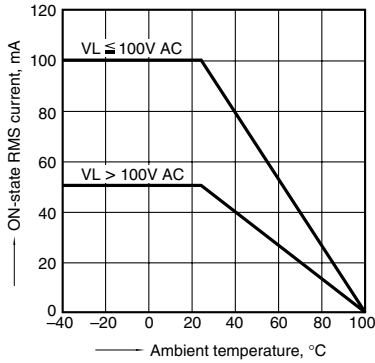

## 1-(5). ON-state RMS current vs. ambient temperature characteristics

Allowable ambient temperature:  $-40^{\circ}\text{C}$  to  $+100^{\circ}\text{C}$   
 $-40^{\circ}\text{F}$  to  $+212^{\circ}\text{F}$

Tested sample: APT1212(A), APT1222(A),  
 APT1212W(A), APT1222W(A)

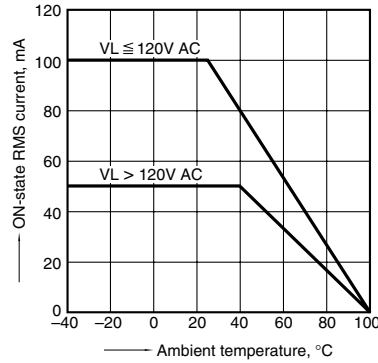

## 1-(6). ON-state RMS current vs. ambient temperature characteristics

Allowable ambient temperature:  $-40^{\circ}\text{C}$  to  $+100^{\circ}\text{C}$   
 $-40^{\circ}\text{F}$  to  $+212^{\circ}\text{F}$

Tested sample: APT1232(A), APT1232W(A)

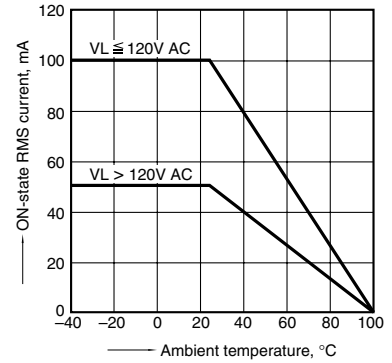

## 2. On voltage vs. ambient temperature characteristics

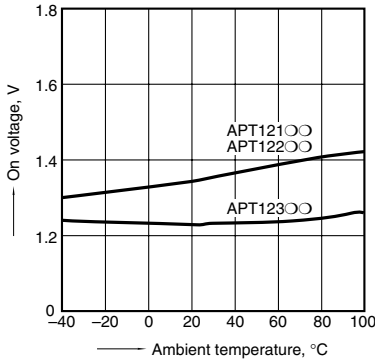

## 3. Trigger LED current vs. ambient temperature characteristics

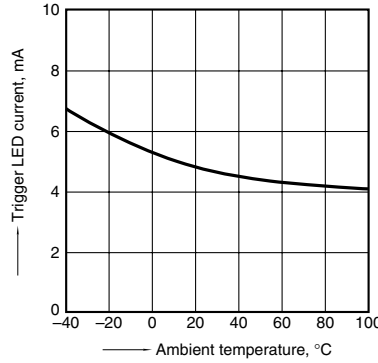

## 4. LED dropout voltage vs. ambient temperature characteristics

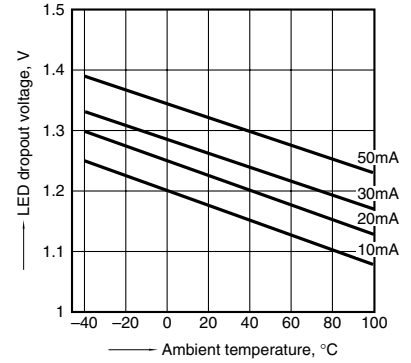

## 5. Turn on time vs. LED current characteristics

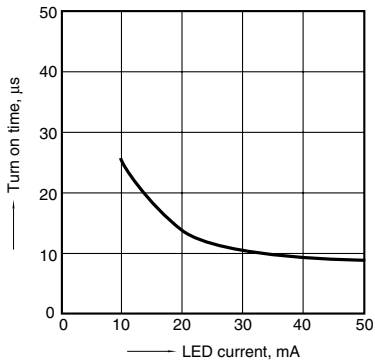

## 6. Repetitive peak OFF-state current vs. Load voltage characteristics

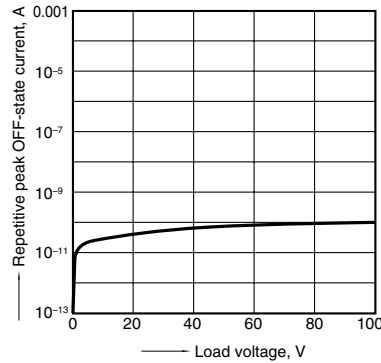

## 7. Hold current vs. ambient temperature characteristics

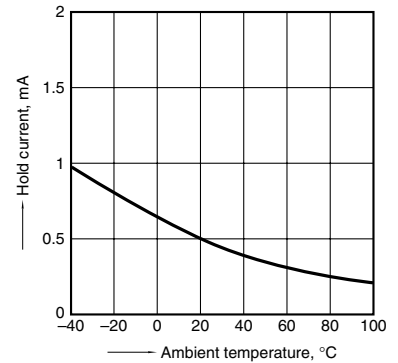

## 8. Zero-cross voltage vs. ambient temperature characteristics

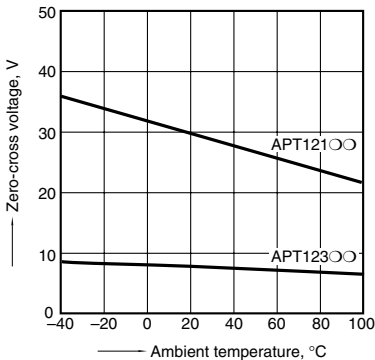

**DIMENSIONS** (mm inch)

The CAD data of the products with a **CAD Data** mark can be downloaded from: <http://industrial.panasonic.com/ac/e/>

**1. SOP Type**

APT1211S, APT1221S, APT1231S

**CAD Data**



External dimensions

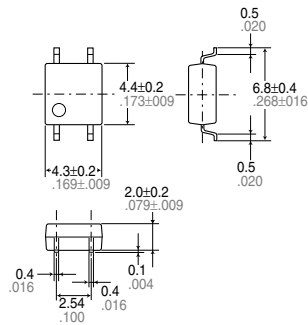

Recommended mounting pad (TOP VIEW)

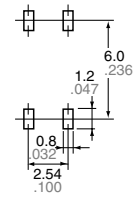

Tolerance: ±0.1 ±.004

Terminal thickness = 0.15 .006

General tolerance: ±0.1 ±.004

**2. DIP4 Type**

APT1211(A), APT1221(A), APT1231(A)

**CAD Data**



External dimensions

Through hole terminal type

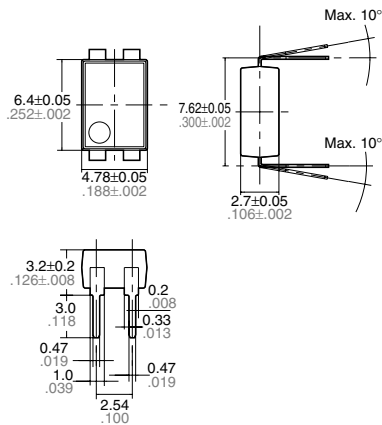

Surface mount terminal type

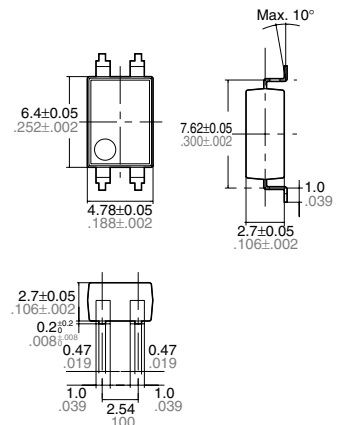

Terminal thickness = 0.20 .008

General tolerance: ±0.1 ±.004

PC board pattern (BOTTOM VIEW)

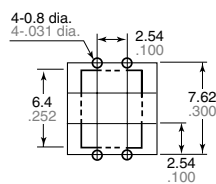

Recommended mounting pad (TOP VIEW)

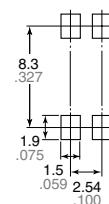

Tolerance: ±0.1 ±.004

Tolerance: ±0.1 ±.004

# APT1

## 3. DIP4 Wide Terminal Type

APT1211W(A), APT1221W(A), APT1231W(A)

### CAD Data



### External dimensions

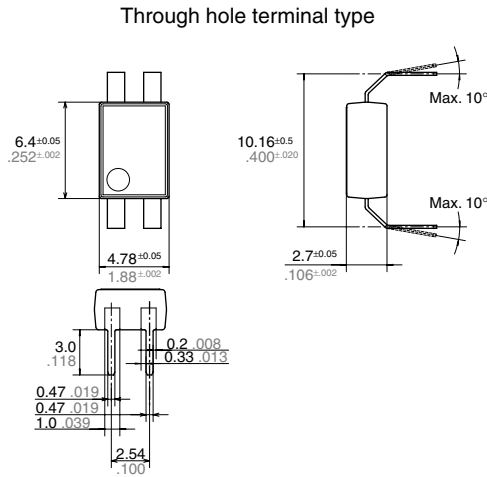

### Surface mount terminal type

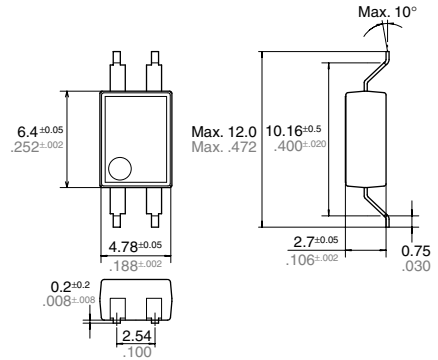

Terminal thickness = 0.20 .008  
General tolerance: ±0.1 ±.004

### PC board pattern (BOTTOM VIEW)

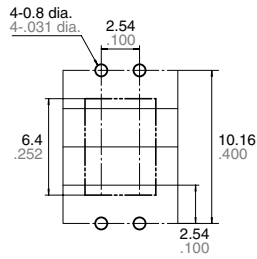

Tolerance: ±0.1 ±.004

### Recommended mounting pad (TOP VIEW)

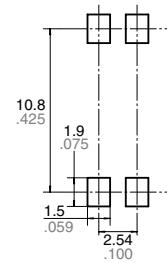

Tolerance: ±0.1 ±.004

## 4. DIP6 Type

APT1212(A), APT1222(A), APT1232(A)

### CAD Data



### External dimensions

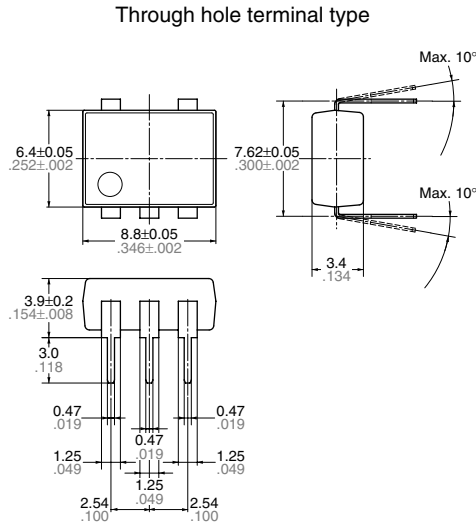

### Surface mount terminal type

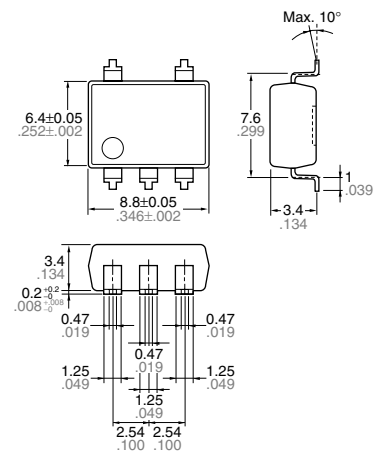

Terminal thickness = 0.25 .010  
General tolerance: ±0.1 ±.004

### PC board pattern (BOTTOM VIEW)

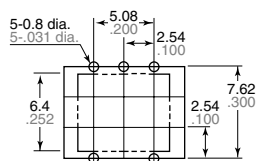

Tolerance: ±0.1 ±.004

### Recommended mounting pad (TOP VIEW)

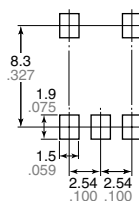

Tolerance: ±0.1 ±.004

5. DIP6 Wide Terminal Type

APT1212W(A), APT1222W(A), APT1232W(A)

CAD Data

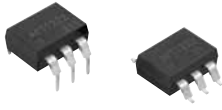

External dimensions

Through hole terminal type

Surface mount terminal type

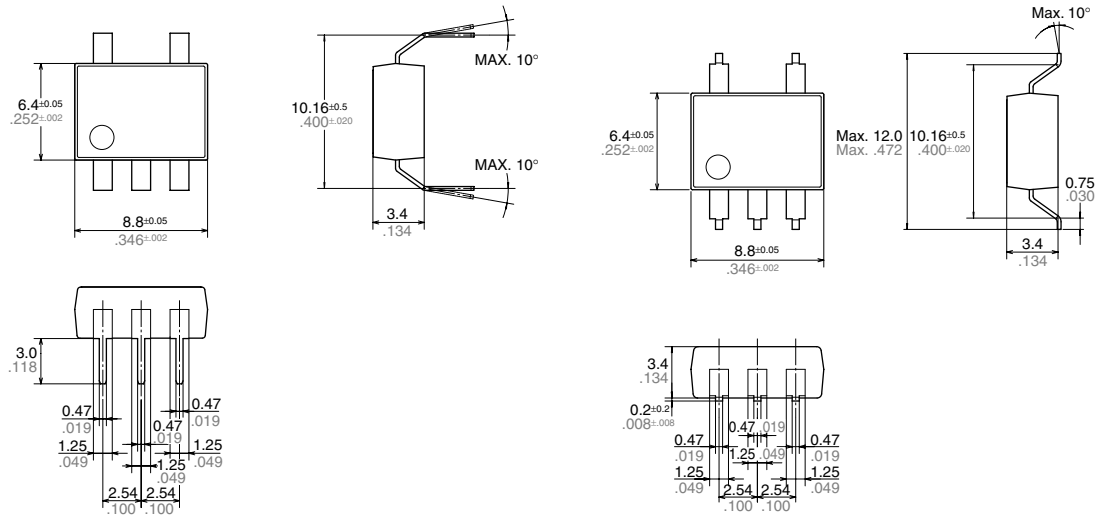

Terminal thickness = 0.25 ±0.10  
General tolerance: ±0.1 ±0.04

PC board pattern (BOTTOM VIEW)

Recommended mounting pad (TOP VIEW)

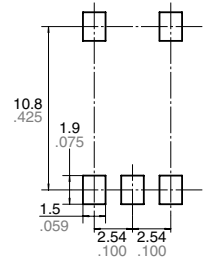
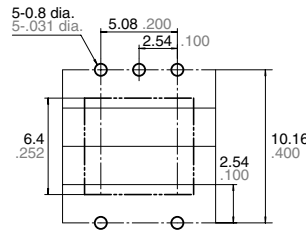

Tolerance: ±0.1 ±0.04

Tolerance: ±0.1 ±0.04

SCHEMATIC AND WIRING DIAGRAMS

Notes: E1: Power source at input side; IF: LED forward current; VL: Load voltage; IL: Load current

Schematic	Output configuration	Load	Wiring diagram
	1 Form A	AC	





## Стандарт Электрон Связь

Мы молодая и активно развивающаяся компания в области поставок электронных компонентов. Мы поставляем электронные компоненты отечественного и импортного производства напрямую от производителей и с крупнейших складов мира.

Благодаря сотрудничеству с мировыми поставщиками мы осуществляем комплексные и плановые поставки широчайшего спектра электронных компонентов.

Собственная эффективная логистика и склад в обеспечивает надежную поставку продукции в точно указанные сроки по всей России.

Мы осуществляем техническую поддержку нашим клиентам и предпродажную проверку качества продукции. На все поставляемые продукты мы предоставляем гарантию .

Осуществляем поставки продукции под контролем ВП МО РФ на предприятия военно-промышленного комплекса России , а также работаем в рамках 275 ФЗ с открытием отдельных счетов в уполномоченном банке. Система менеджмента качества компании соответствует требованиям ГОСТ ISO 9001.

Минимальные сроки поставки, гибкие цены, неограниченный ассортимент и индивидуальный подход к клиентам являются основой для выстраивания долгосрочного и эффективного сотрудничества с предприятиями радиоэлектронной промышленности, предприятиями ВПК и научно-исследовательскими институтами России.

С нами вы становитесь еще успешнее!

### Наши контакты:

**Телефон:** +7 812 627 14 35

**Электронная почта:** [sales@st-electron.ru](mailto:sales@st-electron.ru)

**Адрес:** 198099, Санкт-Петербург,  
Промышленная ул, дом № 19, литера Н,  
помещение 100-Н Офис 331