

Features

- RoHS compliant*
- Conductive plastic or cermet
- Linear and audio tapers
- PC board and bushing mount
- Gangable
- Metal bushing and shaft
- Sealed for board washing



51/53 - Sealed 1/2" (12.5 mm) Square Control

| Electrical Characteristics ¹ | Conductive Plastic | Cermet |
|---|-----------------------------|-----------------------|
| Standard Resistance Range | | |
| Linear | 1 K ohms to 1 megohm..... | 150 ohms to 1 megohm |
| Audio | 1 K ohms to 1 megohm..... | 1 K ohms to 1 megohm |
| Total Resistance Tolerance | | |
| Linear Tapers | ±10 % or ±20 % | ±10 % or ±5 % |
| Audio Tapers | ±10 % or ±20 % | ±10 % |
| Independent Linearity | ±5 % | ±5 % |
| Absolute Minimum Resistance | 2 ohms maximum | 2 ohms maximum |
| Effective Electrical Angle | 270 ° ±5 ° | 270 ° ±5 ° |
| Contact Resistance Variation | 2 % | 2 % |
| Dielectric Withstanding Voltage (MIL-STD-202 – Method 301) | | |
| Sea Level | 1,500 VAC minimum | 1,500 VAC minimum |
| 70,000 | 500 VAC minimum | 500 VAC minimum |
| Insulation Resistance | 1,000 megohms minimum | 1,000 megohms minimum |
| Power Rating At 70 °C (Derate To 0 At 125 °C) (Voltage Limited By Power Dissipation or 350 VAC, Whichever Is Less) | | |
| Linear Tapers | 0.5 watt | 1.0 watt |
| Audio Tapers | 0.25 watt | 0.5 watt |
| Theoretical Resolution | Essentially infinite | Essentially infinite |

| Environmental Characteristics ¹ | Conductive Plastic | Cermet |
|--|-------------------------|-------------------|
| Operating Temperature Range | +1 °C to +125 °C | +1 °C to +125 °C |
| Storage Temperature Range | -55 °C to +125 °C | -55 °C to +125 °C |
| Temperature Coefficient Over Storage Temperature Range | ±1,000 ppm/°C | ±150 ppm/°C |
| Vibration (Single Section) | 15 G | 15 G |
| Total Resistance Shift | ±2 % maximum | ±2 % maximum |
| Voltage Ratio Shift | ±5 % maximum | ±5 % maximum |
| Shock (Single Section) | 30 G | 30 G |
| Total Resistance Shift | +2 % maximum | +2 % maximum |
| Voltage Ratio Shift | ±5 % maximum | ±5 % maximum |
| Load Life | 1,000 hours | 1,000 hours |
| Total Resistance Shift | ±10 % TRS maximum | ±5 % TRS maximum |
| Rotational Life (No Load) | 50,000 cycles | 25,000 cycles |
| Total Resistance Shift | ±10 % TRS maximum | ±10 % TRS maximum |
| Contact Resistance Variation @ 25,000 Cycles | ±2 % | ±4 % |
| Moisture Resistance (MIL-STD-202, Method 103, Condition B) | | |
| Total Resistance Shift | ±10 % TRS | ±5 % TRS |
| IP Rating | | |
| Entire Unit | IP64 | IP64 |
| Shaft/Bushing | IP65 | IP65 |

| Mechanical Characteristics | |
|--|--|
| Stop Strength | 56 N-cm (5 lb.-in.) |
| Mechanical Angle | 290 ° ±5 ° |
| Torque | |
| Starting (Dual Sections) | +0.35 N-cm (+0.5 oz.-in.) maximum |
| Running (Single Section) | 0.15 to 1.4 N-cm (0.2 to 2.0 oz.-in.) |
| Running (Dual Section) | 0.35 to 1.8 N-cm (0.5 to 2.5 oz.-in.) |
| Detent (Single Section) | 1.94 N-cm (2.75 oz.-in.) minimum |
| Mounting (Torque on Bushing) | 1.7 to 2.0 N-m (15 to 18 lb.-in.) maximum |
| Weight (Single Section) | 5.5 grams |
| (Additional Section) | 3.0 grams |
| Terminals | PC pin or solder lug |
| Soldering Condition | Recommended hand soldering using Sn95/Ag5 no clean solder, 0.025" wire diameter. Maximum temperature 399 °C (750 °F) for 3 seconds. No wash process to be used with no clean flux. Part can be wave soldered at 260 °C (500 °F) for 5 seconds, no wash process with no clean flux. |
| Marking | Manufacturer's trademark, part number, resistance value and date code. |
| Ganging (Multiple Section Potentiometer) | 2 sections maximum** |
| Hardware | One lockwasher and one mounting nut is shipped with each potentiometer, except where noted in the part number. |

¹At room ambient: +25 °C nominal and 50 % relative humidity nominal, except as noted.

** Additional sections available on special request with higher minimum order quantities.

51/53 - Sealed 1/2" (12.5 mm) Square Control

BOURNS®

Product Dimensions

PACKAGE DIMENSIONS

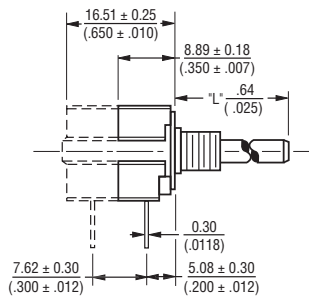

(SINGLE AND DUAL MODULE SHOWN)

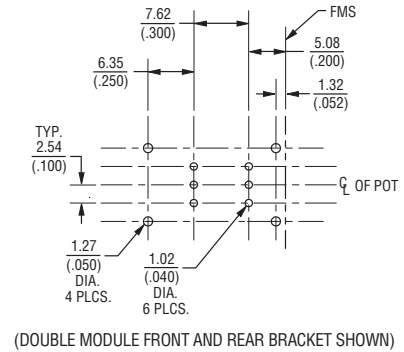
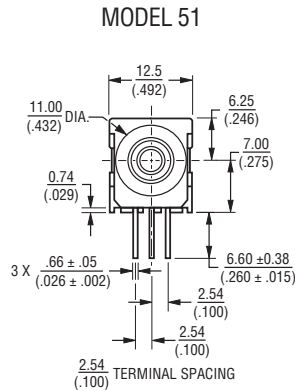

(DOUBLE MODULE FRONT AND REAR BRACKET SHOWN)

PACKAGE DIMENSIONS PCB MOUNTING BRACKET

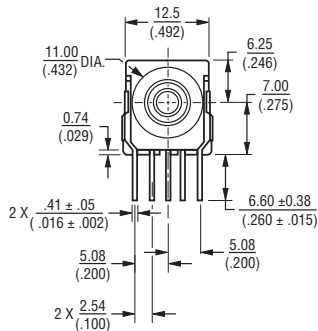
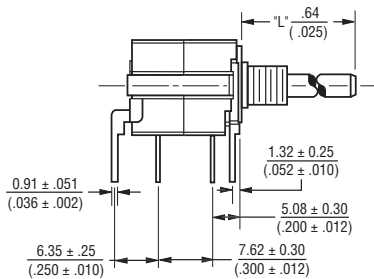

SOLDER LUG TERMINALS MODEL 53

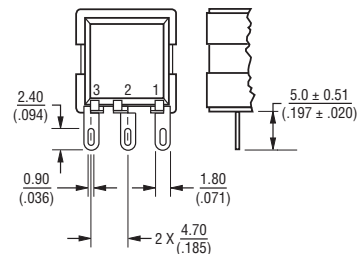

ELECTRICAL SCHEMATIC

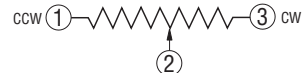

ANTI-ROTATION LUG (Style "A" Shown)

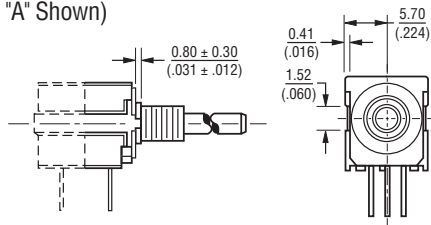

SHAFT FLAT ORIENTATION

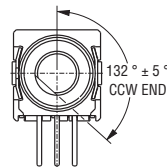

SUGGESTED PANEL LAYOUT

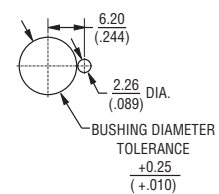

FOR TOLERANCES SHOWN: .XX = ± .25 (.010)
 .XXX = ± .13 (.005)
 SHAFT DIMENSIONS ± .80 (1/32)

DIMENSIONS: $\frac{\text{MM}}{\text{(INCHES)}}$

Specifications are subject to change without notice. The device characteristics and parameters in this data sheet can and do vary in different applications and actual device performance may vary over time. Users should verify actual device performance in their specific applications.

51/53 - Sealed 1/2" (12.5 mm) Square Control

BOURNS®

Shaft/Bushing Styles



| A Style Bushing | |
|-----------------|---------|
| STD. LENGTH 'L' | |
| .500 | (12.7) |
| .625 | (15.88) |
| .750 | (19.05) |
| .875 | (22.23) |
| 1.000 | (25.4) |

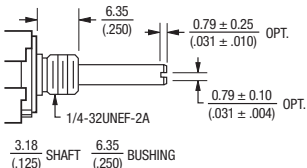

| C Style Bushing | |
|-----------------|---------|
| STD. LENGTH 'L' | |
| .375 | (9.53) |
| .500 | (12.7) |
| .625 | (15.88) |
| .750 | (19.05) |
| .875 | (22.23) |
| 1.000 | (25.4) |



| A Style Bushing - Flatted Shaft | |
|---------------------------------|---------|
| STD. LENGTH 'L' | |
| .625 | (15.88) |
| .750 | (19.05) |
| .875 | (22.23) |
| 1.000 | (25.4) |

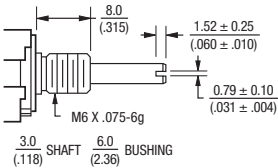

| S Style Bushing | |
|-----------------|--------|
| STD. LENGTH 'L' | |
| .630 | (16.0) |
| .866 | (22.0) |
| .984 | (25.0) |

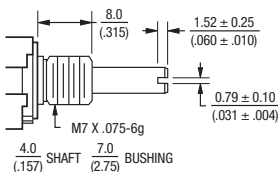

| U Style Bushing | |
|-----------------|--------|
| STD. LENGTH 'L' | |
| .630 | (16.0) |
| .866 | (22.0) |
| .984 | (25.0) |

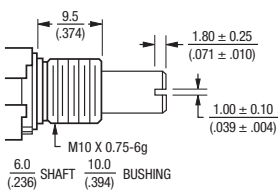

| R Style Bushing | |
|-----------------|--------|
| STD. LENGTH 'L' | |
| .630 | (16.0) |
| .866 | (22.0) |
| .984 | (25.0) |

DIMENSIONS: $\frac{\text{MM}}{\text{(INCHES)}}$

How To Order

51 A A D - B 28 - A 15 / A15 L

Part number for multiple section potentiometers must have a taper and resistance value for each section.

RoHS IDENTIFIER
L Compliant

| MOUNTING BRACKET/ ANTI-ROTATION LUG | |
|-------------------------------------|------------------------|
| Code | Description |
| A | AR Lug 90° CW |
| D | No AR Lug or Bracket |
| L | Front Bracket |
| M | Rear Bracket |
| N | Front and Rear Bracket |

| # SECTIONS/DETENTS | |
|--------------------|------------------------|
| Code | Description |
| A | Single No Detent |
| B | Double No Detent |
| E | Single w/Center Detent |
| F | Double w/Center Detent |

| BUSHING CONFIGURATION | |
|-----------------------|--------------------|
| Code | Description |
| A | 3/8" D x 3/8" L |
| C | 1/4" D x 1/4" L |
| R | 10 mm D x 9.5 mm L |
| S | 6 mm D x 8 mm L |
| U | 7 mm D x 8 mm L |

| MODEL | |
|-------|-------------------------|
| Code | Description |
| 51 | PC Pins (.100" centers) |
| 53 | Solder Lugs |

| ELEMENT TAPER TYPE/TOLERANCE | | RESISTANCE (CODE) | |
|------------------------------|-------------------------------|-------------------|--------------|
| Code | Description | VALUE IN OHMS | |
| (A) | Linear Cermet ±10 % | (28) - 150 | (14) - 7.5 K |
| (H) | Linear Cermet ±5 % | (06) - 200 | (15) - 10 K |
| | | (07) - 250 | (30) - 15 K |
| | | (08) - 500 | (16) - 20 K |
| | | (09) - 750 | (17) - 25 K |
| | | (10) - 1 K | (18) - 50 K |
| | | (29) - 1.5 K | (19) - 75 K |
| | | (11) - 2 K | (20) - 100 K |
| | | (12) - 2.5 K | (21) - 500 K |
| | | (13) - 5 K | (25) - 1 M |
| (B) | Linear C-P ±20 % | (10) - 1 K | (18) - 50 K |
| (E) | Linear C-P ±10 % | (12) - 2.5 K | (20) - 100 K |
| | | (13) - 5 K | (22) - 250 K |
| | | (15) - 10 K | (23) - 500 K |
| | | (16) - 20 K | (25) - 1 M |
| | | (17) - 25 K | |
| (C) | CW Audio Cermet ±10 % | (10) - 1 K | (18) - 50 K |
| (F) | CCW Audio Cermet ±10 % | (12) - 2.5 K | (20) - 100 K |
| | | (13) - 5 K | (23) - 500 K |
| | | (15) - 10 K | (25) - 1 M |
| | | (17) - 25 K | |
| (D) | CW Audio C-P ±20 % | (10) - 1 K | (18) - 50 K |
| (S) | CW Audio C-P ±10 % | (12) - 2.5 K | (20) - 100 K |
| | | (13) - 5 K | (22) - 250 K |
| | | (15) - 10 K | (23) - 500 K |
| | | (17) - 25 K | (25) - 1 M |
| (G) | CCW Audio C-P ±20 % | (10) - 1 K | (18) - 50 K |
| (T) | CCW Audio C-P ±10 % | (12) - 2.5 K | (20) - 100 K |
| | | (13) - 5 K | (22) - 250 K |
| | | (15) - 10 K | (23) - 500 K |
| | | (17) - 25 K | (25) - 1 M |
| (Y) | CW Dual Audio Taper C-P ±20 % | (10) - 1 K | (18) - 50 K |
| | | (12) - 2.5 K | (20) - 100 K |
| | | (13) - 5 K | (22) - 250 K |
| | | (15) - 10 K | (23) - 500 K |
| | | (17) - 25 K | (25) - 1 M |

| SHAFT TYPE | | AVAILABLE ONLY IN BUSHINGS | |
|------------|-----------------------|----------------------------|----------------|
| Code | Description | Code | Description |
| B | Single Slotted 1/4" D | A | 24,28 |
| C | Single Flatted 1/4" D | A | 20,24,28,32 |
| E | Single Slotted 1/8" D | C | 12,16,20,24,28 |
| R | Single Slotted 6 mm D | R | 16,22,25 |
| T | Single Slotted 4 mm D | U | 16,22,25 |
| U | Single Slotted 3 mm D | S | 16,22,25 |

| SHAFT LENGTH (FMS) | | AVAILABLE ONLY IN BUSHING |
|--------------------|-------------|---------------------------|
| Code | Description | Code |
| 12 | 3/8" | C |
| 16 | 1/2" | A, C |
| 20 | 5/8" | A, C |
| 24 | 3/4" | A, C |
| 28 | 7/8" | A, C |
| 32 | 1" | A, C |
| Metric | | |
| 16 | 16 mm | R, S, U |
| 22 | 22 mm | R, S, U |
| 25 | 25 mm | R, S, U |

Boldface features are Bourns standard options. All others are available with higher minimum order quantities.



**Стандарт
Электрон
Связь**

Мы молодая и активно развивающаяся компания в области поставок электронных компонентов. Мы поставляем электронные компоненты отечественного и импортного производства напрямую от производителей и с крупнейших складов мира.

Благодаря сотрудничеству с мировыми поставщиками мы осуществляем комплексные и плановые поставки широчайшего спектра электронных компонентов.

Собственная эффективная логистика и склад в обеспечивает надежную поставку продукции в точно указанные сроки по всей России.

Мы осуществляем техническую поддержку нашим клиентам и предпродажную проверку качества продукции. На все поставляемые продукты мы предоставляем гарантию .

Осуществляем поставки продукции под контролем ВП МО РФ на предприятия военно-промышленного комплекса России , а также работаем в рамках 275 ФЗ с открытием отдельных счетов в уполномоченном банке. Система менеджмента качества компании соответствует требованиям ГОСТ ISO 9001.

Минимальные сроки поставки, гибкие цены, неограниченный ассортимент и индивидуальный подход к клиентам являются основой для выстраивания долгосрочного и эффективного сотрудничества с предприятиями радиоэлектронной промышленности, предприятиями ВПК и научно-исследовательскими институтами России.

С нами вы становитесь еще успешнее!

Наши контакты:

Телефон: +7 812 627 14 35

Электронная почта: sales@st-electron.ru

Адрес: 198099, Санкт-Петербург,
Промышленная ул, дом № 19, литера Н,
помещение 100-Н Офис 331