



Features

- RoHS compliant*
- Conductive plastic or cermet
- Linear and audio tapers
- PC board and bushing mount
- Gangable
- Metal bushing and shaft
- Sealed for board washing



51/53 - Sealed 1/2" (12.5 mm) Square Control

Electrical Characteristics ¹	Conductive Plastic	Cermet
Standard Resistance Range		
Linear	1 K ohms to 1 megohm.....	150 ohms to 1 megohm
Audio	1 K ohms to 1 megohm.....	1 K ohms to 1 megohm
Total Resistance Tolerance		
Linear Tapers	±10 % or ±20 %	±10 % or ±5 %
Audio Tapers	±10 % or ±20 %	±10 %
Independent Linearity	±5 %	±5 %
Absolute Minimum Resistance	2 ohms maximum.....	2 ohms maximum
Effective Electrical Angle	270 ° ±5 °	270 ° ±5 °
Contact Resistance Variation	2 %	2 %
Dielectric Withstanding Voltage (MIL-STD-202 – Method 301)		
Sea Level.....	1,500 VAC minimum.....	1,500 VAC minimum
70,000	500 VAC minimum.....	500 VAC minimum
Insulation Resistance	1,000 megohms minimum.....	1,000 megohms minimum
Power Rating At 70 °C (Derate To 0 At 125 °C) (Voltage Limited By Power Dissipation or 350 VAC, Whichever Is Less)		
Linear Tapers	0.5 watt.....	1.0 watt
Audio Tapers	0.25 watt.....	0.5 watt
Theoretical Resolution.....	Essentially infinite	Essentially infinite

Environmental Characteristics ¹	Conductive Plastic	Cermet
Operating Temperature Range	+1 °C to +125 °C.....	+1 °C to +125 °C
Storage Temperature Range	-55 °C to +125 °C.....	-55 °C to +125 °C
Temperature Coefficient Over Storage Temperature Range	±1,000 ppm/°C.....	±150 ppm/°C
Vibration (Single Section)	15 G.....	15 G
Total Resistance Shift.....	±2 % maximum	±2 % maximum
Voltage Ratio Shift.....	±5 % maximum	±5 % maximum
Shock (Single Section)	30 G.....	30 G
Total Resistance Shift.....	+2 % maximum	±2 % maximum
Voltage Ratio Shift.....	±5 % maximum	±5 % maximum
Load Life.....	1,000 hours	1,000 hours
Total Resistance Shift.....	±10 % TRS maximum	±5 % TRS maximum
Rotational Life (No Load).....	50,000 cycles	25,000 cycles
Total Resistance Shift.....	±10 % TRS maximum	±10 % TRS maximum
Contact Resistance Variation @ 25,000 Cycles	±2 %	±4 %
Moisture Resistance (MIL-STD-202, Method 103, Condition B)		
Total Resistance Shift.....	±10 % TRS.....	±5 % TRS
IP Rating		
Entire Unit.....	IP64	IP64
Shaft/Bushing.....	IP65	IP65

Mechanical Characteristics	
Stop Strength	56 N-cm (5 lb.-in.)
Mechanical Angle	290 ° ±5 °
Torque	
Starting (Dual Sections).....	+0.35 N-cm (+0.5 oz.-in.) maximum
Running (Single Section).....	0.15 to 1.4 N-cm (0.2 to 2.0 oz.-in.)
Running (Dual Section).....	0.35 to 1.8 N-cm (0.5 to 2.5 oz.-in.)
Detent (Single Section).....	1.94 N-cm (2.75 oz.-in.) minimum
Mounting (Torque on Bushing)	1.7 to 2.0 N-m (15 to 18 lb.-in.) maximum
Weight (Single Section).....	5.5 grams
(Additional Section)	3.0 grams
Terminals	PC pin or solder lug
Soldering Condition	Recommended hand soldering using Sn95/Ag5 no clean solder, 0.025" wire diameter. Maximum temperature 399 °C (750 °F) for 3 seconds. No wash process to be used with no clean flux. Part can be wave soldered at 260 °C (500 °F) for 5 seconds, no wash process with no clean flux.
Marking.....	Manufacturer's trademark, part number, resistance value and date code.
Ganging (Multiple Section Potentiometer)	2 sections maximum**
Hardware.....	One lockwasher and one mounting nut is shipped with each potentiometer, except where noted in the part number.

¹At room ambient: +25 °C nominal and 50 % relative humidity nominal, except as noted.

** Additional sections available on special request with higher minimum order quantities.

*RoHS Directive 2002/95/EC Jan. 27, 2003 including annex and RoHS Recast 2011/65/EU June 8, 2011.

Specifications are subject to change without notice.

The device characteristics and parameters in this data sheet can and do vary in different applications and actual device performance may vary over time. Users should verify actual device performance in their specific applications.

51/53 - Sealed 1/2" (12.5 mm) Square Control

BOURNS®

Product Dimensions

PACKAGE DIMENSIONS

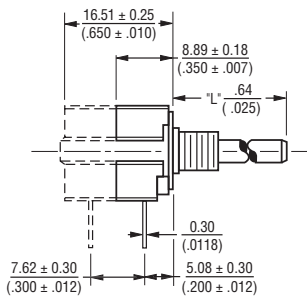

(SINGLE AND DUAL MODULE SHOWN)

MODEL 51

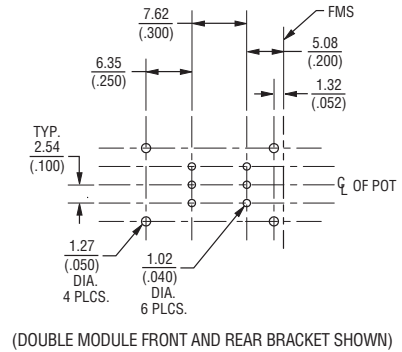
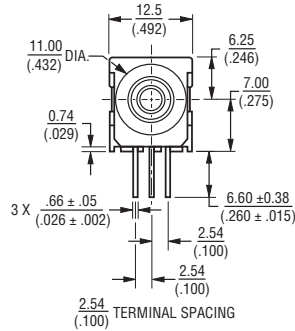

(DOUBLE MODULE FRONT AND REAR BRACKET SHOWN)

PACKAGE DIMENSIONS PCB MOUNTING BRACKET

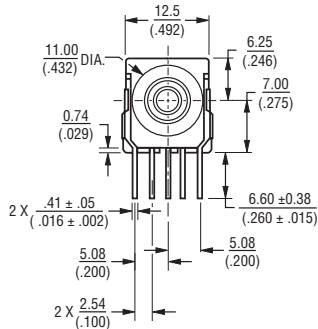
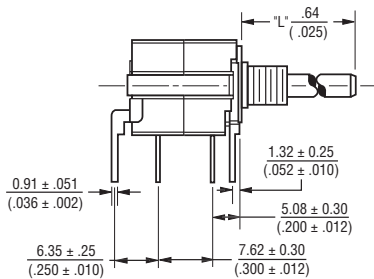

SOLDER LUG TERMINALS MODEL 53

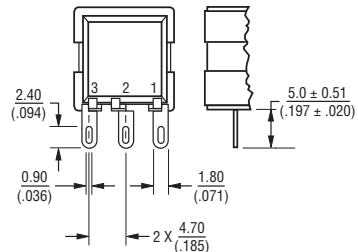

ELECTRICAL SCHEMATIC

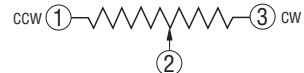

ANTI-ROTATION LUG (Style "A" Shown)

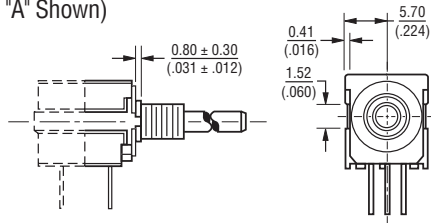

SHAFT FLAT ORIENTATION

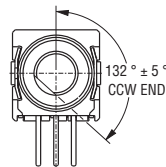

SUGGESTED PANEL LAYOUT

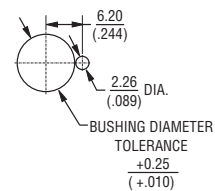

FOR TOLERANCES SHOWN: .XX = ± .25 (.010)
 .XXX = ± .13 (.005)
 SHAFT DIMENSIONS ± .80 (1/32)

DIMENSIONS: $\frac{\text{MM}}{\text{(INCHES)}}$

Specifications are subject to change without notice. The device characteristics and parameters in this data sheet can and do vary in different applications and actual device performance may vary over time. Users should verify actual device performance in their specific applications.

51/53 - Sealed 1/2" (12.5 mm) Square Control

BOURNS®

Shaft/Bushing Styles



A Style Bushing	
STD. LENGTH 'L'	
.500	(12.7)
.625	(15.88)
.750	(19.05)
.875	(22.23)
1.000	(25.4)



C Style Bushing	
STD. LENGTH 'L'	
.375	(9.53)
.500	(12.7)
.625	(15.88)
.750	(19.05)
.875	(22.23)
1.000	(25.4)



A Style Bushing - Flatted Shaft	
STD. LENGTH 'L'	
.625	(15.88)
.750	(19.05)
.875	(22.23)
1.000	(25.4)



S Style Bushing	
STD. LENGTH 'L'	
.630	(16.0)
.866	(22.0)
.984	(25.0)



U Style Bushing	
STD. LENGTH 'L'	
.630	(16.0)
.866	(22.0)
.984	(25.0)



R Style Bushing	
STD. LENGTH 'L'	
.630	(16.0)
.866	(22.0)
.984	(25.0)

DIMENSIONS: $\frac{\text{MM}}{\text{(INCHES)}}$

How To Order

51 A A D - B 28 - A 15 / A15 L

Part number for multiple section potentiometers must have a taper and resistance value for each section.

RoHS IDENTIFIER
L Compliant

MOUNTING BRACKET/ ANTI-ROTATION LUG	
Code	Description
A	AR Lug 90° CW
D	No AR Lug or Bracket
L	Front Bracket
M	Rear Bracket
N	Front and Rear Bracket

# SECTIONS/DETENTS	
Code	Description
A	Single No Detent
B	Double No Detent
E	Single w/Center Detent
F	Double w/Center Detent

BUSHING CONFIGURATION	
Code	Description
A	3/8" D x 3/8" L
C	1/4" D x 1/4" L
R	10 mm D x 9.5 mm L
S	6 mm D x 8 mm L
U	7 mm D x 8 mm L

MODEL	
Code	Description
51	PC Pins (.100" centers)
53	Solder Lugs

ELEMENT TAPER TYPE/TOLERANCE		RESISTANCE (CODE)	
Code	Description	VALUE IN OHMS	
(A)	Linear Cermet ±10 %	(28) - 150	(14) - 7.5 K
(H)	Linear Cermet ±5 %	(06) - 200	(15) - 10 K
		(07) - 250	(30) - 15 K
		(08) - 500	(16) - 20 K
		(09) - 750	(17) - 25 K
		(10) - 1 K	(18) - 50 K
		(29) - 1.5 K	(19) - 75 K
		(11) - 2 K	(20) - 100 K
		(12) - 2.5 K	(21) - 500 K
		(13) - 5 K	(25) - 1 M
(B)	Linear C-P ±20 %	(10) - 1 K	(18) - 50 K
(E)	Linear C-P ±10 %	(12) - 2.5 K	(20) - 100 K
		(13) - 5 K	(22) - 250 K
		(15) - 10 K	(23) - 500 K
		(16) - 20 K	(25) - 1 M
		(17) - 25 K	
(C)	CW Audio Cermet ±10 %	(10) - 1 K	(18) - 50 K
(F)	CCW Audio Cermet ±10 %	(12) - 2.5 K	(20) - 100 K
		(13) - 5 K	(23) - 500 K
		(15) - 10 K	(25) - 1 M
		(17) - 25 K	
(D)	CW Audio C-P ±20 %	(10) - 1 K	(18) - 50 K
(S)	CW Audio C-P ±10 %	(12) - 2.5 K	(20) - 100 K
		(13) - 5 K	(22) - 250 K
		(15) - 10 K	(23) - 500 K
		(17) - 25 K	(25) - 1 M
(G)	CCW Audio C-P ±20 %	(10) - 1 K	(18) - 50 K
(T)	CCW Audio C-P ±10 %	(12) - 2.5 K	(20) - 100 K
		(13) - 5 K	(22) - 250 K
		(15) - 10 K	(23) - 500 K
		(17) - 25 K	(25) - 1 M
(Y)	CW Dual Audio Taper C-P ±20 %	(10) - 1 K	(18) - 50 K
		(12) - 2.5 K	(20) - 100 K
		(13) - 5 K	(22) - 250 K
		(15) - 10 K	(23) - 500 K
		(17) - 25 K	(25) - 1 M

SHAFT TYPE		AVAILABLE ONLY IN BUSHINGS	
Code	Description	Code	Description
B	Single Slotted 1/4" D	A	24,28
C	Single Flatted 1/4" D	A	20,24,28,32
E	Single Slotted 1/8" D	C	12,16,20,24,28
R	Single Slotted 6 mm D	R	16,22,25
T	Single Slotted 4 mm D	U	16,22,25
U	Single Slotted 3 mm D	S	16,22,25

SHAFT LENGTH (FMS)		AVAILABLE ONLY IN BUSHING
Code	Description	Code
12	3/8"	C
16	1/2"	A, C
20	5/8"	A, C
24	3/4"	A, C
28	7/8"	A, C
32	1"	A, C
Metric		
16	16 mm	R, S, U
22	22 mm	R, S, U
25	25 mm	R, S, U

Boldface features are Bourns standard options. All others are available with higher minimum order quantities.



Стандарт Электрон Связь

Мы молодая и активно развивающаяся компания в области поставок электронных компонентов. Мы поставляем электронные компоненты отечественного и импортного производства напрямую от производителей и с крупнейших складов мира.

Благодаря сотрудничеству с мировыми поставщиками мы осуществляем комплексные и плановые поставки широчайшего спектра электронных компонентов.

Собственная эффективная логистика и склад в обеспечивает надежную поставку продукции в точно указанные сроки по всей России.

Мы осуществляем техническую поддержку нашим клиентам и предпродажную проверку качества продукции. На все поставляемые продукты мы предоставляем гарантию .

Осуществляем поставки продукции под контролем ВП МО РФ на предприятия военно-промышленного комплекса России , а также работаем в рамках 275 ФЗ с открытием отдельных счетов в уполномоченном банке. Система менеджмента качества компании соответствует требованиям ГОСТ ISO 9001.

Минимальные сроки поставки, гибкие цены, неограниченный ассортимент и индивидуальный подход к клиентам являются основой для выстраивания долгосрочного и эффективного сотрудничества с предприятиями радиоэлектронной промышленности, предприятиями ВПК и научно-исследовательскими институтами России.

С нами вы становитесь еще успешнее!

Наши контакты:

Телефон: +7 812 627 14 35

Электронная почта: sales@st-electron.ru

Адрес: 198099, Санкт-Петербург,
Промышленная ул, дом № 19, литера Н,
помещение 100-Н Офис 331