



## General Description

The AZV358 is dual low voltage (2.7-5.5V) operational amplifiers which have rail-to-rail output swing capability. The input common-mode voltage range includes ground. The chip exhibits excellent speed-power ratio, achieving 1MHz of bandwidth and 1V/ $\mu$ s of slew rate with low supply current.

The AZV358 is built with BiCMOS process. It has bipolar input and output stages for improved noise performance, low input offset voltage and higher output current drive.

AZV358 is available in the package of TSSOP-8 and MSOP-8. The small packages save space on pc boards, and enable the design of small portable electronic devices. It also allows the designer to place the device closer to the signal source to reduce noise pickup and increase signal integrity.

AZV358 is also available in standard SOIC-8 package.

## Features

(For  $V_{CC}=5V$  and  $V_{EE}=0V$ , typical unless otherwise noted)

- Guaranteed 2.7V to 5.5V Performance
- No Crossover Distortion
- Gain-Bandwidth Product 1MHz
- Industrial Temperature Range:  $-40^{\circ}C$  to  $+85^{\circ}C$
- Low Supply Current: 210 $\mu$ A
- Rail-to-Rail Output Swing under 10k $\Omega$  Load:
  - $V_{OH}$  up to  $V_{CC} - 10mV$
  - $V_{OL}$  near to  $V_{EE} + 65mV$
- $V_{CM}$ :  $-0.1V$  to  $V_{CC} - 0.8V$

## Applications

- Active Filters
- Low Power, Low Voltage Applications
- General Purpose Portable Devices
- Cellular Phone, Cordless Phone
- Battery-Powered Systems



Figure 1. Package Types of AZV358

**Pin Configuration**

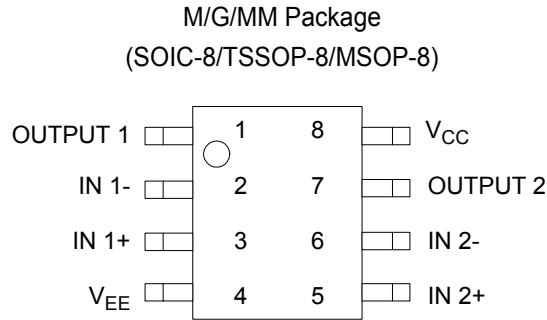

Figure 2. Pin Configuration of AZV358 (Top View)

**Functional Block Diagram**

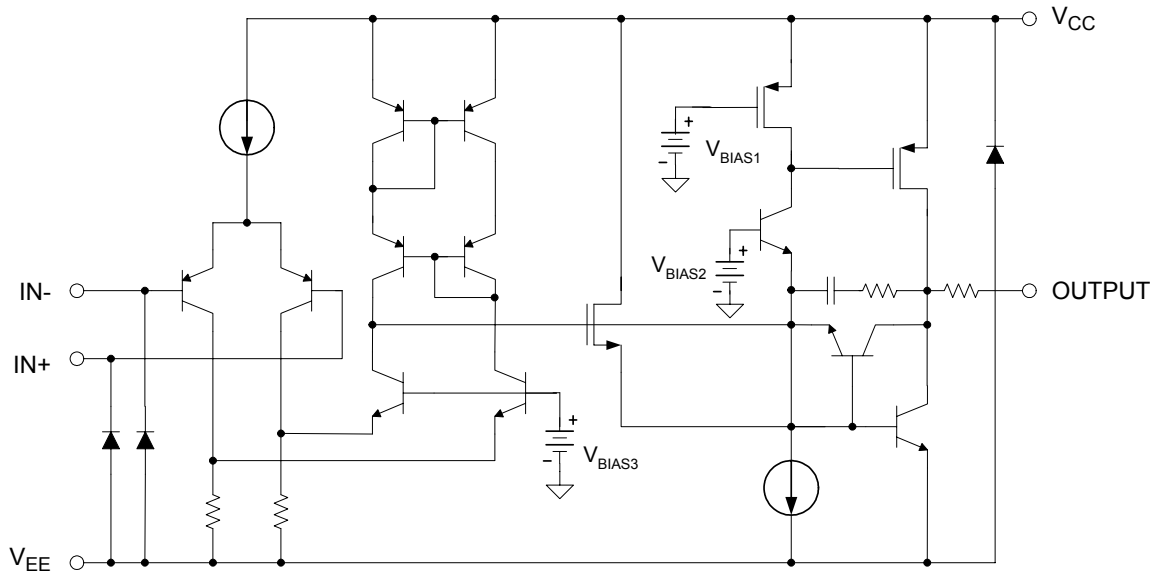
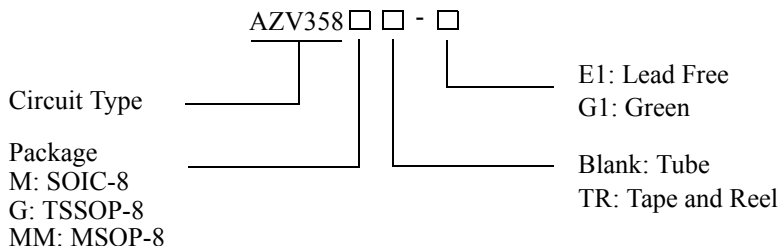

Figure 3. Functional Block Diagram of AZV358 (Each Block)



**DUAL LOW VOLTAGE RAIL-TO-RAIL OUTPUT OPERATIONAL AMPLIFIERS      AZV358**

**Ordering Information**



Package	Temperature Range	Part Number		Marking ID		Packing Type
		Lead Free	Green	Lead Free	Green	
SOIC-8	-40 to 85°C	AZV358M-E1	AZV358M-G1	AZV358M-E1	AZV358M-G1	Tube
		AZV358MTR-E1	AZV358MTR-G1	AZV358M-E1	AZV358M-G1	Tape & Reel
TSSOP-8	-40 to 85°C	AZV358G-E1	AZV358G-G1	EG3E	GG3E	Tube
		AZV358GTR-E1	AZV358GTR-G1	EG3E	GG3E	Tape & Reel
MSOP-8	-40 to 85°C	AZV358MM-E1	AZV358MM-G1	AZV358MM-E1	AZV358MM-G1	Tube
		AZV358MMTR-E1	AZV358MMTR-G1	AZV358MM-E1	AZV358MM-G1	Tape & Reel

BCD Semiconductor's Pb-free products, as designated with "E1" suffix in the part number, are RoHS compliant. Products with "G1" suffix are available in green packages.

**Absolute Maximum Ratings (Note 1)**

Parameter	Symbol	Value	Unit
Power Supply Voltage	V <sub>CC</sub>	6	V
Operation Junction Temperature	T <sub>J</sub>	150	°C
Storage Temperature Range	T <sub>STG</sub>	-65 to 150	°C
Lead Temperature (Soldering, 10 Seconds)	T <sub>LEAD</sub>	260	°C
ESD (Machine Model)		200	V
ESD (Human Body Model)		2000	V

Note 1: Stresses greater than those listed under "Absolute Maximum Ratings" may cause permanent damage to the device. These are stress ratings only, and functional operation of the device at these or any other conditions beyond those indicated under "Recommended Operating Conditions" is not implied. Exposure to "Absolute Maximum Ratings" for extended periods may affect device reliability.

**Recommended Operating Conditions**

Parameter	Symbol	Min	Max	Unit
Supply Voltage	V <sub>CC</sub>	2.7	5.5	V
Ambient Operating Temperature Range	T <sub>A</sub>	-40	85	°C



**DUAL LOW VOLTAGE RAIL-TO-RAIL OUTPUT OPERATIONAL AMPLIFIERS AZV358**

**2.7V Electrical Characteristics**

Limits in standard typeface are for  $T_A=25^{\circ}\text{C}$ , **bold** typeface applies over  $T_A=-40^{\circ}\text{C}$  to  $85^{\circ}\text{C}$ ,  $V_{CC}=2.7\text{V}$ ,  $V_{EE}=0\text{V}$ ,  $V_{CM}=1.0\text{V}$ ,  $V_O=V_{CC}/2$  and  $R_L>1\text{M}\Omega$ , unless otherwise specified. (Note 2)

Parameter	Symbol	Conditions	Min	Typ	Max	Unit
Input Offset Voltage	$V_{IO}$			1.7	7	mV
					<b>9</b>	
Input Bias Current	$I_B$			11	250	nA
					<b>500</b>	
Input Offset Current	$I_{IO}$			5	50	nA
					<b>150</b>	
Input Common Mode Voltage Range	$V_{CM}$	for $\text{CMRR}\geq 50\text{dB}$	-0.1		1.9	V
Supply Current	$I_{CC}$	$V_O=V_{CC}/2$ , $A_{VCL}=1$ , No load		140	340	$\mu\text{A}$
					<b>420</b>	
Common Mode Rejection Ratio	CMRR	$0\leq V_{CM}\leq 1.7\text{V}$	50	63		dB
Power Supply Rejection Ratio	PSRR	$2.7\text{V}\leq V_{CC}\leq 5\text{V}$ $V_O=1\text{V}$ ,	50	60		dB
Output Short Circuit Current	$I_{SOURCE}$	$V_O=0\text{V}$	5	20		mA
	$I_{SINK}$	$V_O=2.7\text{V}$	10	30		mA
Output Voltage Swing	$V_{OH}$	$R_L=10\text{k}\Omega$ to 1.35V	2.60	2.69		V
	$V_{OL}$			60	180	mV
Gain Bandwidth Product	GBWP	$C_L=200\text{pF}$		1		MHz
Phase Margin	$\phi_M$			60		deg
Gain Margin	$G_M$			10		dB

Note 2: Limits over the full temperature are guaranteed by design, but not tested in production.



**DUAL LOW VOLTAGE RAIL-TO-RAIL OUTPUT OPERATIONAL AMPLIFIERS AZV358**

**5V Electrical Characteristics**

Limits in standard typeface are for  $T_A=25^{\circ}\text{C}$ , **bold** typeface applies over  $T_A=-40^{\circ}\text{C}$  to  $85^{\circ}\text{C}$ ,  $V_{CC}=5\text{V}$ ,  $V_{EE}=0\text{V}$ ,  $V_{CM}=2.0\text{V}$ ,  $V_O=V_{CC}/2$  and  $R_L>1\text{M}\Omega$ , unless otherwise specified. (Note 2)

Parameter	Symbol	Conditions	Min	Typ	Max	Unit
Input Offset Voltage	$V_{IO}$			1.7	7	mV
					<b>9</b>	
Input Bias Current	$I_B$			15	250	nA
					<b>500</b>	
Input Offset Current	$I_{IO}$			5	50	nA
					<b>150</b>	
Input Common Mode Voltage Range	$V_{CM}$	for $\text{CMRR}\geq 50\text{dB}$	-0.1		4.2	V
Supply Current	$I_{CC}$	$V_O=V_{CC}/2$ , $A_{VCL}=1$ , No load		210	440	$\mu\text{A}$
					<b>615</b>	
Large Signal Voltage Gain	$G_V$	$R_L=2\text{k}\Omega$	84	100		dB
			<b>80</b>			
Common Mode Rejection Ratio	CMRR	$0\leq V_{CM}\leq 4\text{V}$	50	63		dB
Power Supply Rejection Ratio	PSRR	$2.7\text{V}\leq V_{CC}\leq 5\text{V}$ $V_O=1\text{V}$ , $V_{CM}=1\text{V}$	50	60		dB
Output Short Circuit Current	$I_{SOURCE}$	$V_O=0\text{V}$	5	60		mA
	$I_{SINK}$	$V_O=5\text{V}$	10	160		mA
Output Voltage Swing	$V_{OH}$	$R_L=2\text{k}\Omega$ to 2.5V	4.7	4.96		V
			<b>4.6</b>			
		$R_L=10\text{k}\Omega$ to 2.5V	4.9	4.99		
			<b>4.8</b>			
	$V_{OL}$	$R_L=2\text{k}\Omega$ to 2.5V		120	300	mV
					<b>400</b>	
$R_L=10\text{k}\Omega$ to 2.5V			65	180		
				<b>280</b>		
Slew Rate	SR		1		V/ $\mu\text{s}$	
Gain Bandwidth Product	GBWP	$C_L=200\text{pF}$		1		MHz
Phase Margin	$\phi_M$			60		deg
Gain Margin	$G_M$			10		dB

Note 2: Limits over the full temperature are guaranteed by design, but not tested in production.



### Typical Performance Characteristics

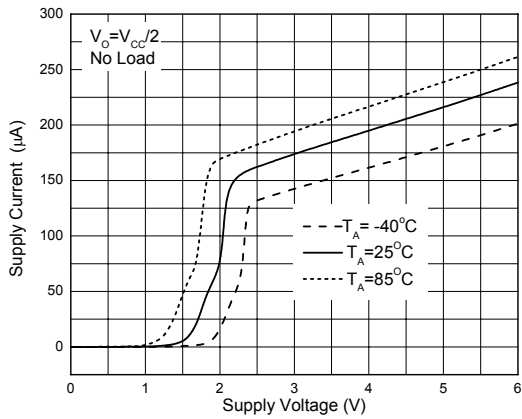

Figure 4. Supply Current vs. Supply Voltage

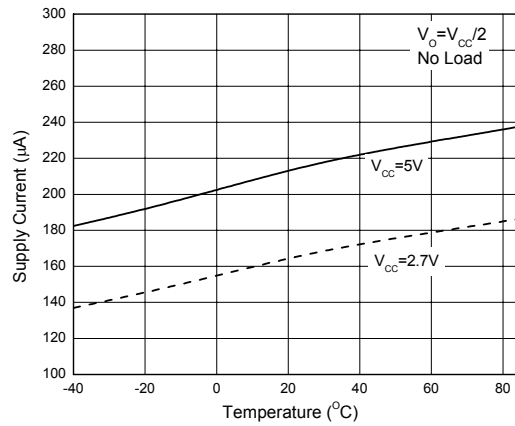

Figure 5. Supply Current vs. Temperature

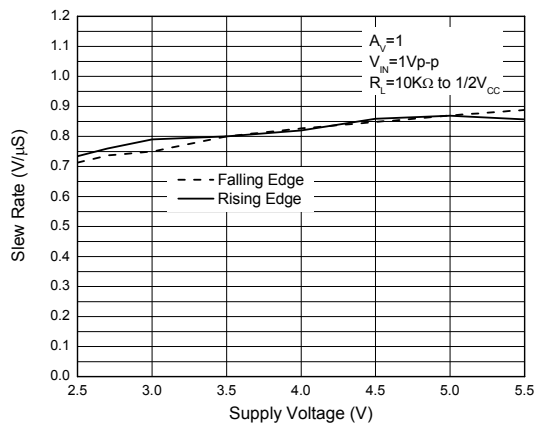

Figure 6. Slew Rate vs. Supply Voltage

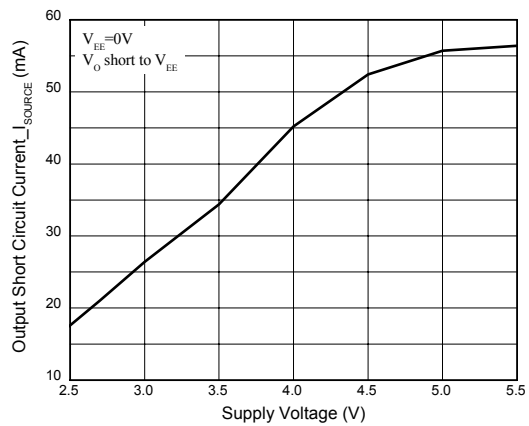

Figure 7. Output Short Circuit Current vs. Supply Voltage



Typical Performance Characteristics (Continued)

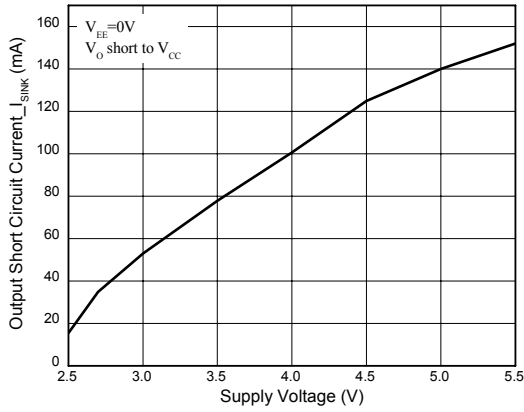

Figure 8. Output Short Circuit Current vs. Supply Voltage

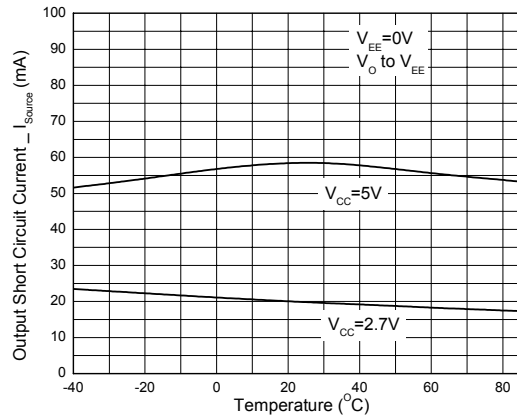

Figure 9. Output Short Circuit Current vs. Temperature

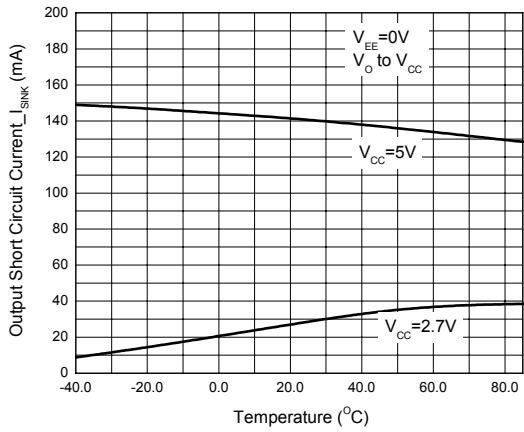

Figure 10. Output Short Circuit Current vs. Temperature

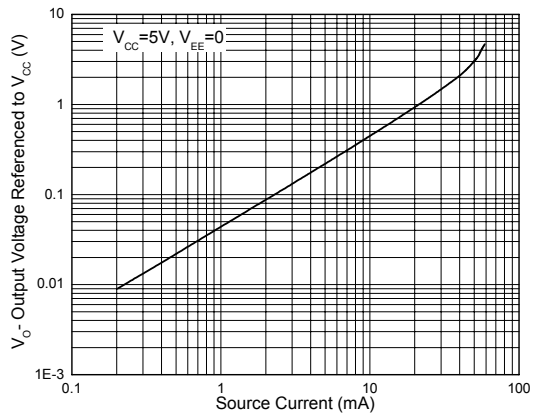

Figure 11. Output Voltage vs. Output Source Current



Typical Performance Characteristics (Continued)

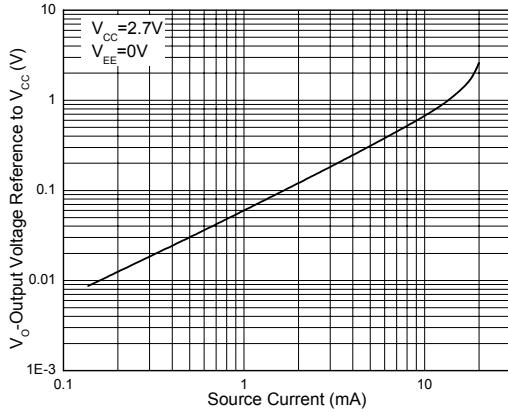

Figure 12. Output Voltage vs. Output Source Current

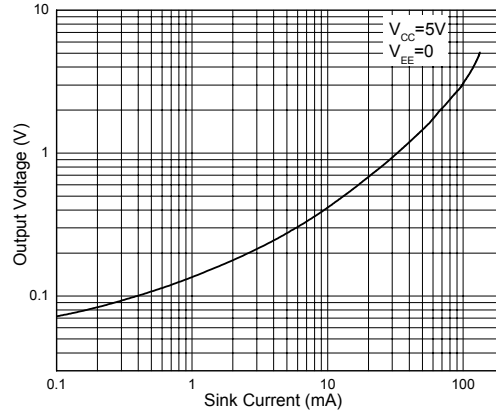

Figure 13. Output Voltage vs. Output Sink Current

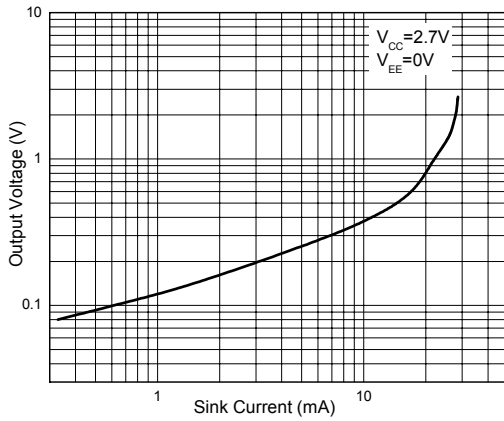

Figure 14. Output Voltage vs. Output Sink Current

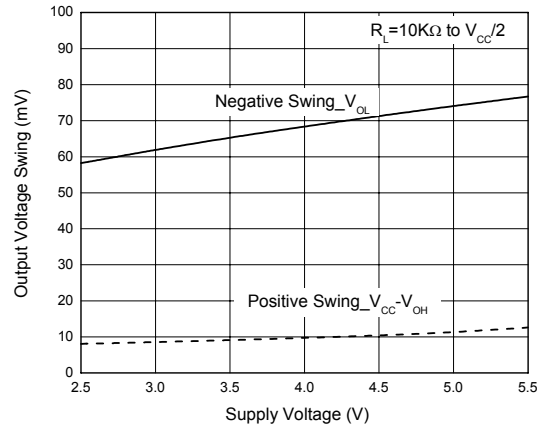

Figure 15. Output Voltage Swing vs. Supply Voltage





Typical Performance Characteristics (Continued)

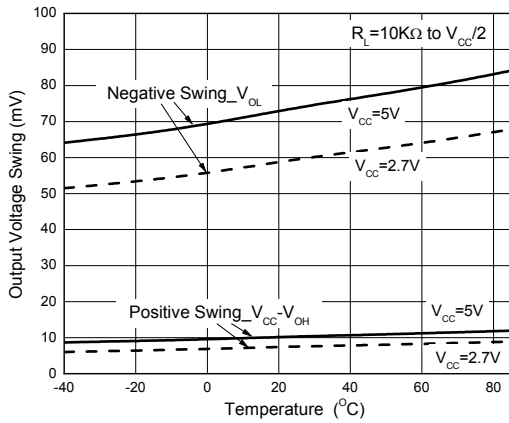

Figure 16. Output Voltage Swing vs. Temperature

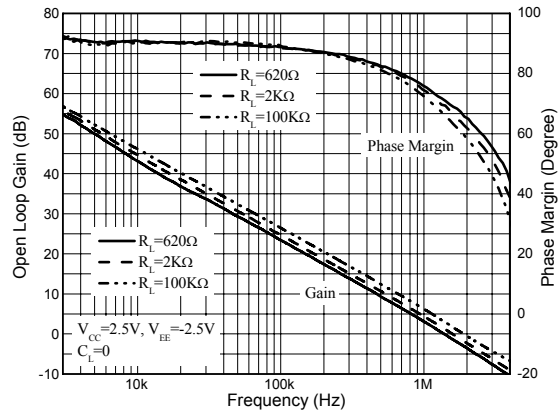

Figure 17. Gain and Phase vs. Frequency and Resistive Load

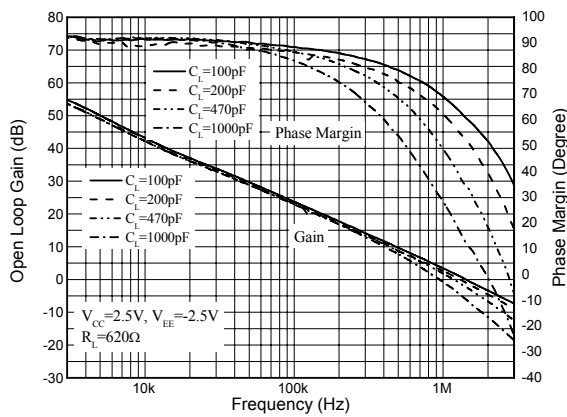

Figure 18. Gain and Phase vs. Frequency and Capacitive Load

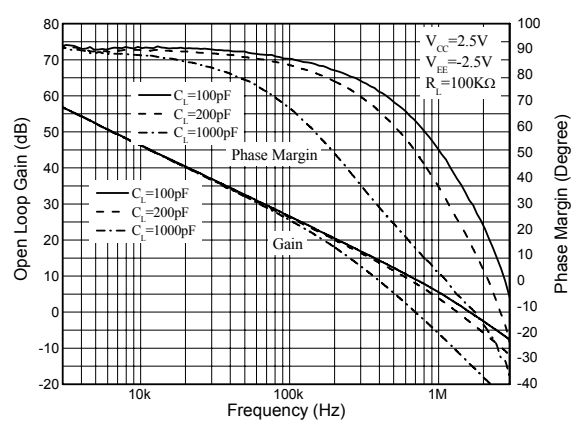

Figure 19. Gain and Phase vs. Frequency and Capacitive Load

Typical Performance Characteristics (Continued)

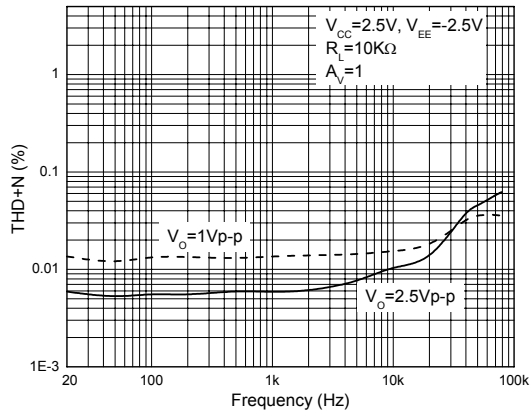

Figure 20. THD+N vs. Frequency

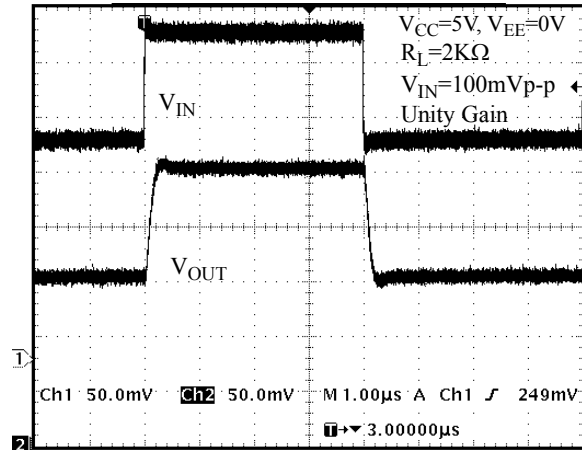

Figure 21. Non-Inverting Input Small Signal Pulse Response

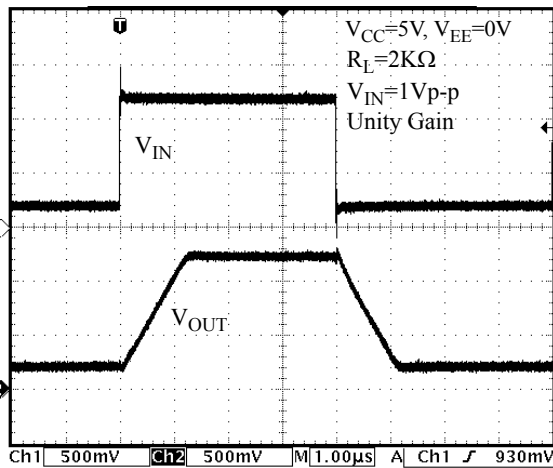

Figure 22. Non-Inverting Input Large Signal Pulse Response

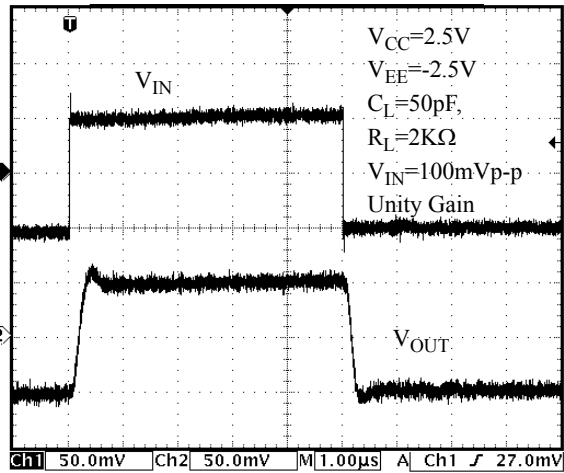

Figure 23. Non-Inverting Input Small Signal Response

**Typical Performance Characteristics (Continued)**

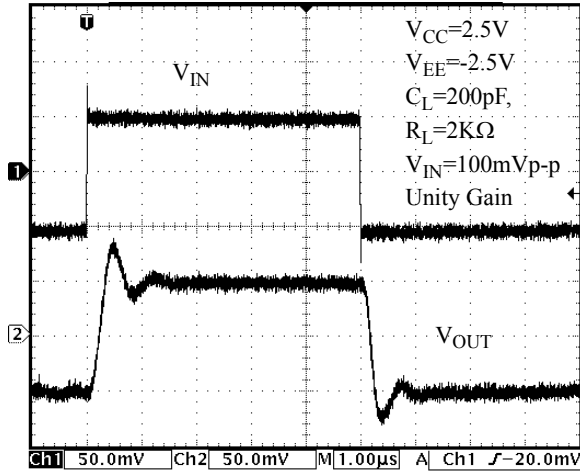

Figure 24. Non-Inverting Input Small Signal Response



Mechanical Dimensions

SOIC-8

Unit: mm(inch)

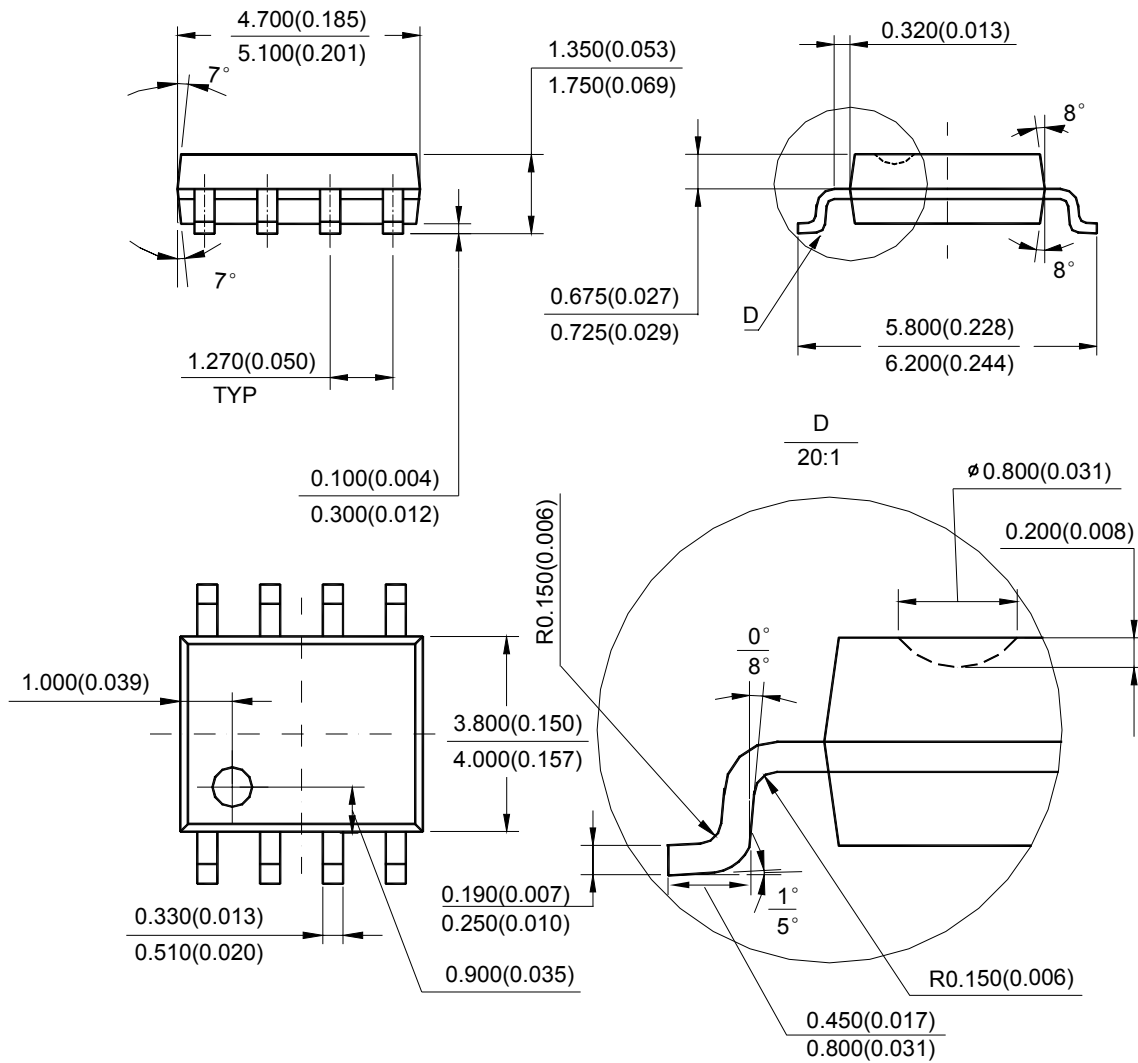

Note: Eject hole, oriented hole and mold mark is optional.



Mechanical Dimensions (Continued)

TSSOP-8

Unit: mm(inch)

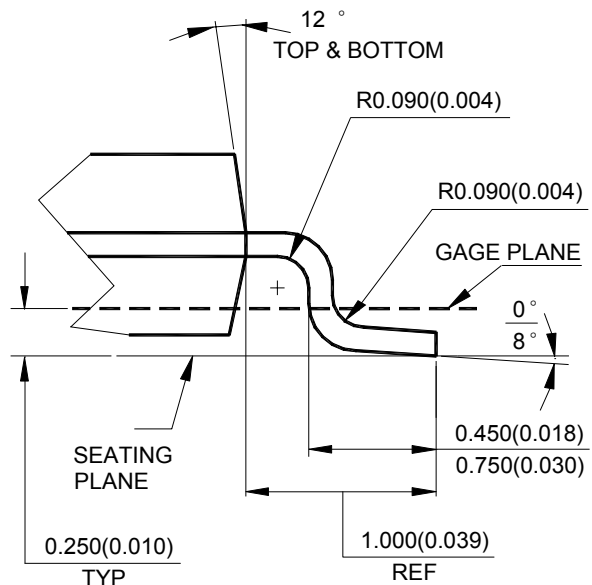
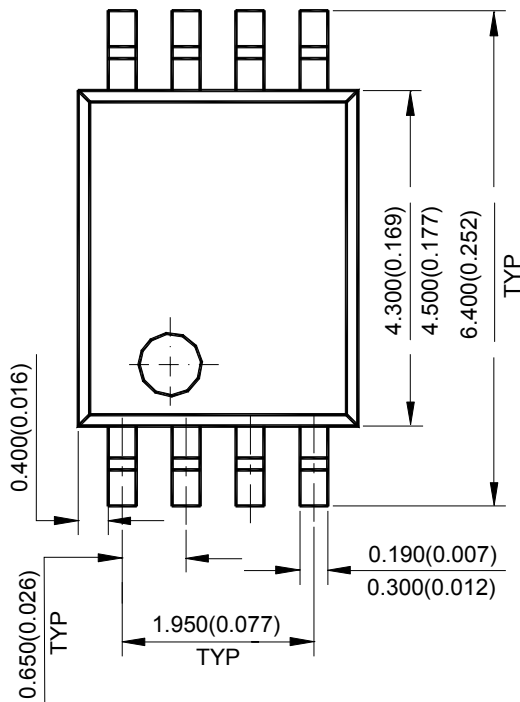
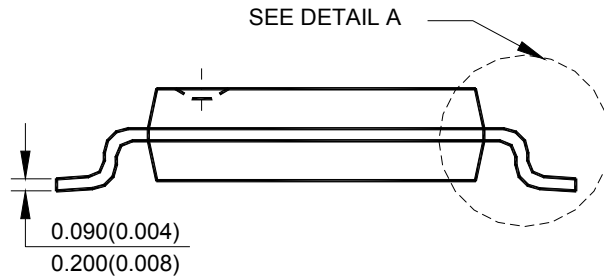
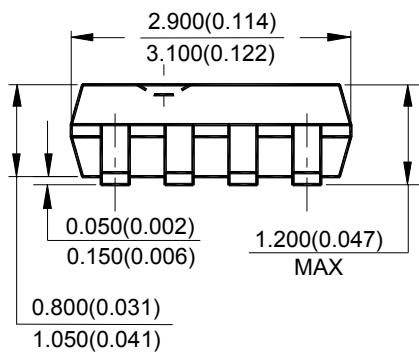

DETAIL A

Note: Eject hole, oriented hole and mold mark is optional.



Mechanical Dimensions (Continued)

MSOP-8

Unit: mm(inch)

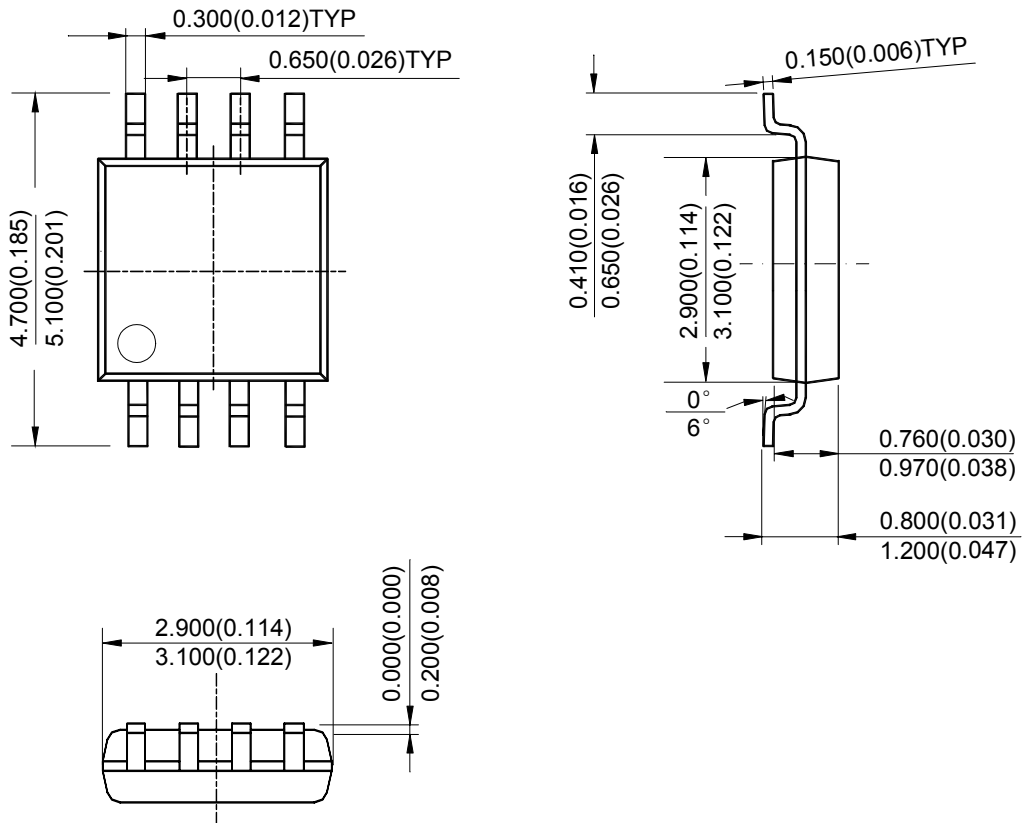

Note: Eject hole, oriented hole and mold mark is optional.



## **BCD Semiconductor Manufacturing Limited**

<http://www.bcdsemi.com>

### **IMPORTANT NOTICE**

BCD Semiconductor Manufacturing Limited reserves the right to make changes without further notice to any products or specifications herein. BCD Semiconductor Manufacturing Limited does not assume any responsibility for use of any its products for any particular purpose, nor does BCD Semiconductor Manufacturing Limited assume any liability arising out of the application or use of any its products or circuits. BCD Semiconductor Manufacturing Limited does not convey any license under its patent rights or other rights nor the rights of others.

---

#### **MAIN SITE**

##### **- Headquarters**

##### **BCD Semiconductor Manufacturing Limited**

No. 1600, Zi Xing Road, Shanghai Zizhu Science-based Industrial Park, 200241, China  
Tel: +86-21-24162266, Fax: +86-21-24162277

##### **- Wafer Fab**

##### **Shanghai SIM-BCD Semiconductor Manufacturing Co., Ltd.**

800 Yi Shan Road, Shanghai 200233, China  
Tel: +86-21-6485 1491, Fax: +86-21-5450 0008

#### **REGIONAL SALES OFFICE**

##### **Shenzhen Office**

##### **Shanghai SIM-BCD Semiconductor Manufacturing Co., Ltd., Shenzhen Office**

Unit A Room 1203, Skyworth Bldg., Gaoxin Ave. 1.S., Nanshan District, Shenzhen, China  
Tel: +86-755-8826 7951  
Fax: +86-755-8826 7865

##### **Taiwan Office**

##### **BCD Semiconductor (Taiwan) Company Limited**

4F, 298-1, Rui Guang Road, Nei-Hu District, Taipei, Taiwan  
Tel: +886-2-2656 2808  
Fax: +886-2-2656 2806

##### **USA Office**

##### **BCD Semiconductor Corp.**

30920 Huntwood Ave. Hayward, CA 94544, USA  
Tel : +1-510-324-2988  
Fax: +1-510-324-2788



**Стандарт  
Электрон  
Связь**

Мы молодая и активно развивающаяся компания в области поставок электронных компонентов. Мы поставляем электронные компоненты отечественного и импортного производства напрямую от производителей и с крупнейших складов мира.

Благодаря сотрудничеству с мировыми поставщиками мы осуществляем комплексные и плановые поставки широчайшего спектра электронных компонентов.

Собственная эффективная логистика и склад в обеспечивает надежную поставку продукции в точно указанные сроки по всей России.

Мы осуществляем техническую поддержку нашим клиентам и предпродажную проверку качества продукции. На все поставляемые продукты мы предоставляем гарантию .

Осуществляем поставки продукции под контролем ВП МО РФ на предприятия военно-промышленного комплекса России , а также работаем в рамках 275 ФЗ с открытием отдельных счетов в уполномоченном банке. Система менеджмента качества компании соответствует требованиям ГОСТ ISO 9001.

Минимальные сроки поставки, гибкие цены, неограниченный ассортимент и индивидуальный подход к клиентам являются основой для выстраивания долгосрочного и эффективного сотрудничества с предприятиями радиоэлектронной промышленности, предприятиями ВПК и научно-исследовательскими институтами России.

С нами вы становитесь еще успешнее!

**Наши контакты:**

**Телефон:** +7 812 627 14 35

**Электронная почта:** [sales@st-electron.ru](mailto:sales@st-electron.ru)

**Адрес:** 198099, Санкт-Петербург,  
Промышленная ул, дом № 19, литера Н,  
помещение 100-Н Офис 331