

CARMEN-W-C

~55° wide beam. Assembly with holder C compatible with LEDiL HEKLA.

TECHNICAL SPECIFICATIONS:

Dimensions	Ø 69.5 mm
Height	41.5 mm
Fastening	socket
ROHS compliant	yes ⓘ

MATERIAL SPECIFICATIONS:

Component	Type	Material	Colour	Finish
CARMEN-W	Single lens	PMMA		
CARMEN-HLD-C	Holder	PC		



ORDERING INFORMATION:

Component	Type	Qty in box	MOQ	MPQ	Box weight (kg)
CP15776_CARMEN-W-C » Box size: 476 x 273 x 292 mm	Single lens	150	150	15	4.5

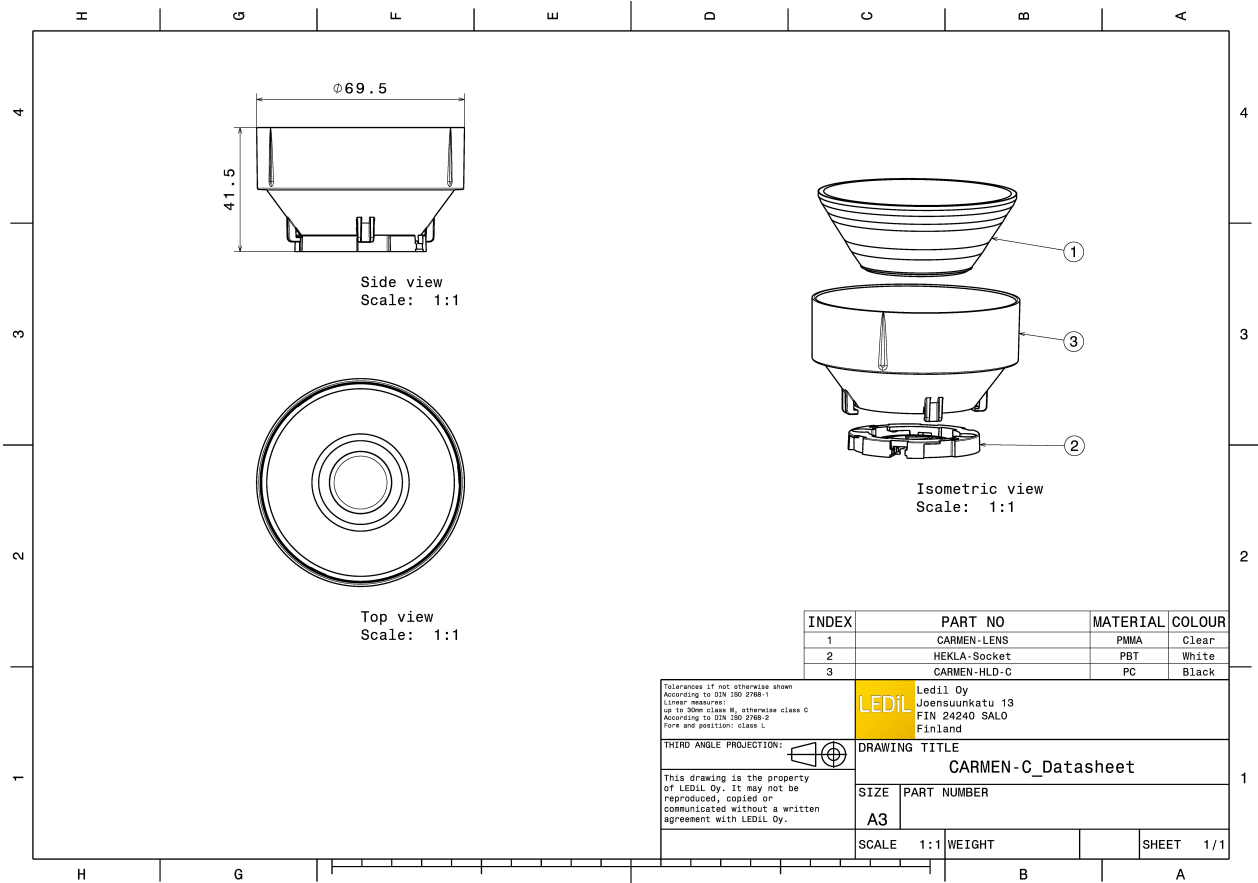

PHOTOMETRIC DATA (MEASURED):

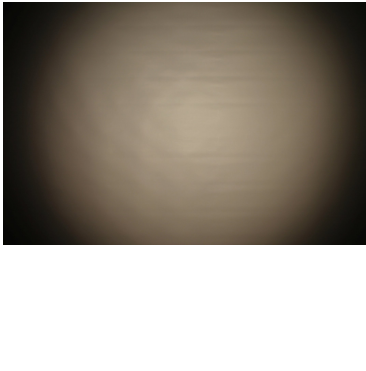
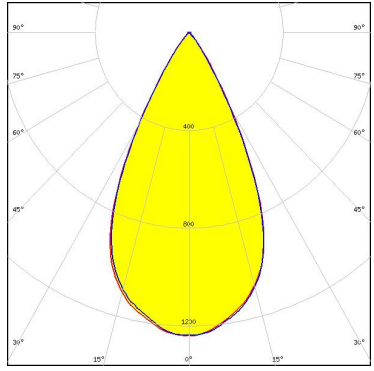
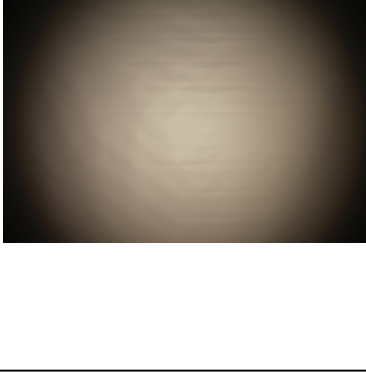
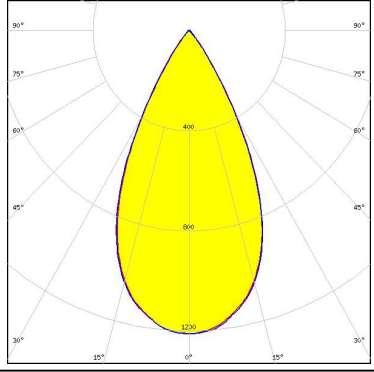
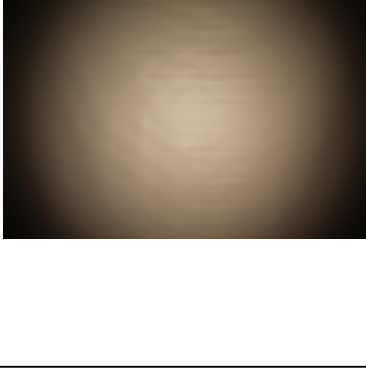
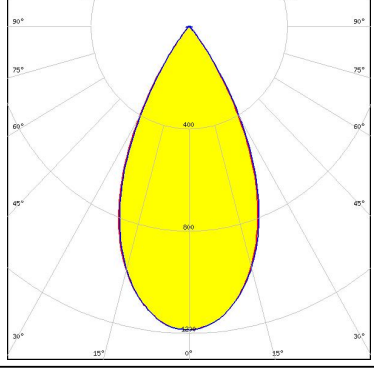
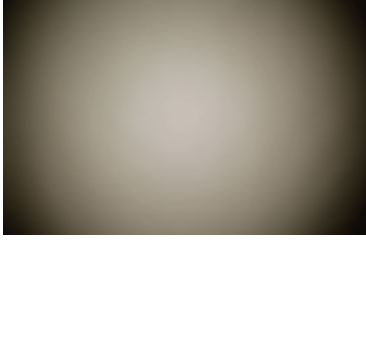
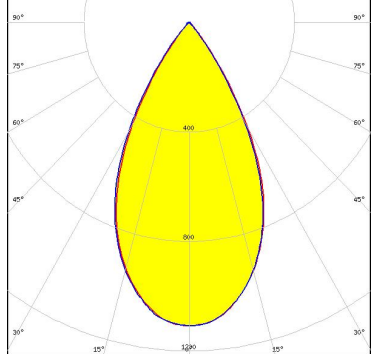
<p>bridgelux.</p> <p>LED V4 HD FWHM 52.0° Efficiency 85 % Peak intensity 1.200 cd/lm LEDs/each optic 1 Light colour White Required components: F15253_HEKLA-SOCKET-A</p>		
<p>bridgelux.</p> <p>LED V6 HD FWHM 52.0° Efficiency 83 % Peak intensity 1.200 cd/lm LEDs/each optic 1 Light colour White Required components: F15255_HEKLA-SOCKET-C</p>		
<p>bridgelux.</p> <p>LED V9 HD FWHM 52.0° Efficiency 81 % Peak intensity 1.190 cd/lm LEDs/each optic 1 Light colour White Required components: F15859_HEKLA-SOCKET-I</p>		
<p>bridgelux.</p> <p>LED VERO10 FWHM 55.0° Efficiency 83 % Peak intensity 6.900 cd/lm LEDs/each optic 1 Light colour White Required components:</p>		

PHOTOMETRIC DATA (MEASURED):

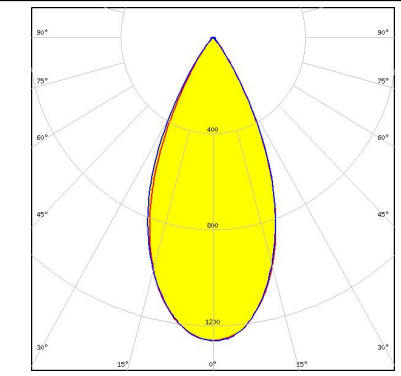
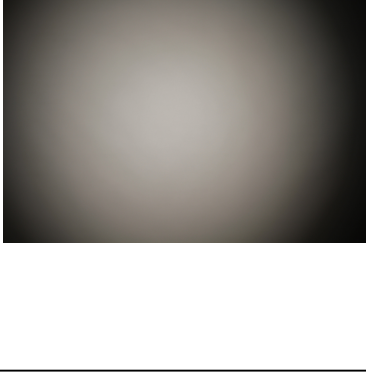
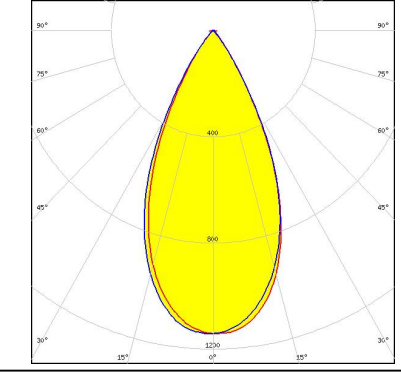
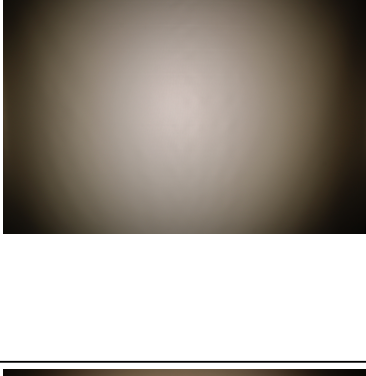
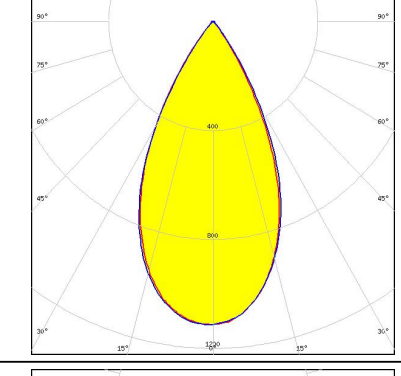
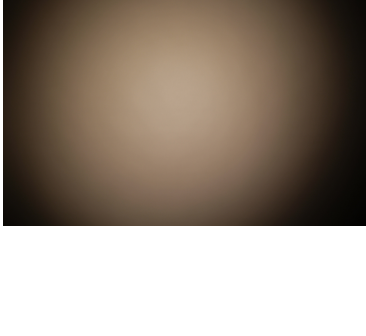
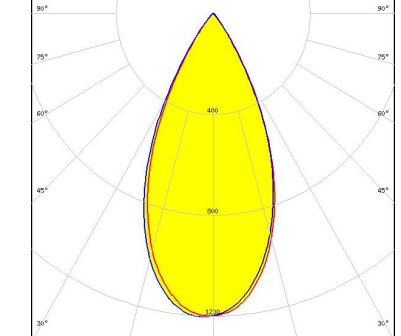
<p>bridgelux.</p> <p>LED Vesta DTW 9mm (4W/6W/12W)</p> <p>FWHM 48.0°</p> <p>Efficiency 76 %</p> <p>Peak intensity 1.300 cd/lm</p> <p>LEDs/each optic 1</p> <p>Light colour White</p> <p>Required components: C16142_HEKLA-SOCKET-K Bender Wirth: 490 Typ L8</p>		
<p>bridgelux.</p> <p>LED Vesta TW 9mm (12W) CSP</p> <p>FWHM 50.0°</p> <p>Efficiency 75 %</p> <p>Peak intensity 1.100 cd/lm</p> <p>LEDs/each optic 1</p> <p>Light colour White</p> <p>Required components: C16142_HEKLA-SOCKET-K</p>		
<p>bridgelux.</p> <p>LED Vesta TW 9mm (9W) DP</p> <p>FWHM 52.0°</p> <p>Efficiency 77 %</p> <p>Peak intensity 1.115 cd/lm</p> <p>LEDs/each optic 1</p> <p>Light colour White</p> <p>Required components: C16142_HEKLA-SOCKET-K Bender Wirth: 489 Typ L8</p>		
<p>CITIZEN</p> <p>LED CLC020 Series (Dim-To-Warm)</p> <p>FWHM 48.0°</p> <p>Efficiency 75 %</p> <p>Peak intensity 1.200 cd/lm</p> <p>LEDs/each optic 1</p> <p>Light colour White</p> <p>Required components: C16142_HEKLA-SOCKET-K</p>		

PHOTOMETRIC DATA (MEASURED):

CITIZEN

LED CLL02x/CLU02x (LES10)
 FWHM 54.0°
 Efficiency 82 %
 Peak intensity 1.100 cd/lm
 LEDs/each optic 1
 Light colour White
 Required components:
 F15255_HEKLA-SOCKET-C

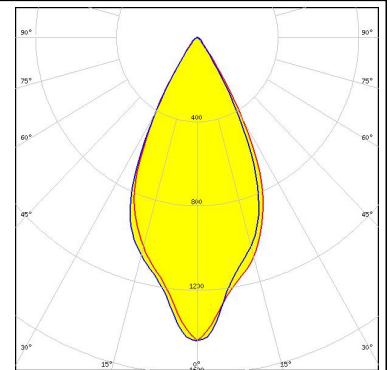
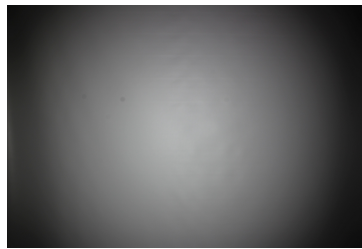

CITIZEN

LED CLU700/701/702
 FWHM 52.0°
 Efficiency 85 %
 Peak intensity 1.200 cd/lm
 LEDs/each optic 1
 Light colour White
 Required components:
 F15255_HEKLA-SOCKET-C

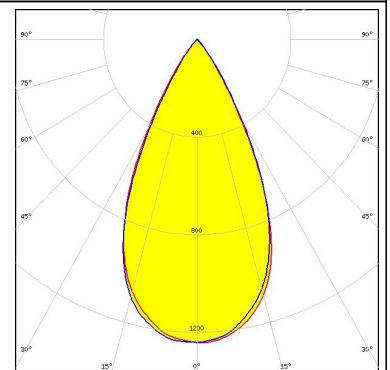
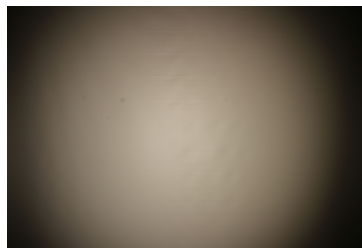

CITIZEN

LED CLU710/711
 FWHM 52.0°
 Efficiency 81 %
 Peak intensity 1.183 cd/lm
 LEDs/each optic 1
 Light colour White
 Required components:
 F15859_HEKLA-SOCKET-I

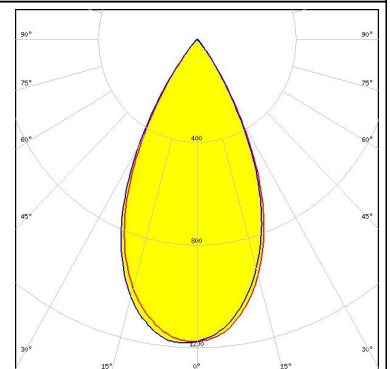
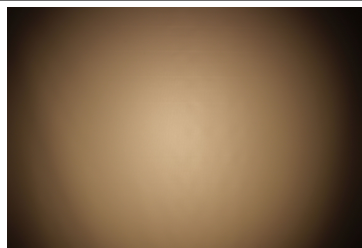

CITIZEN

LED CLU7A2 (LES 4.2mm)
 FWHM 54.0°
 Efficiency 86 %
 Peak intensity 1.200 cd/lm
 LEDs/each optic 1
 Light colour White
 Required components:
 F15255_HEKLA-SOCKET-C

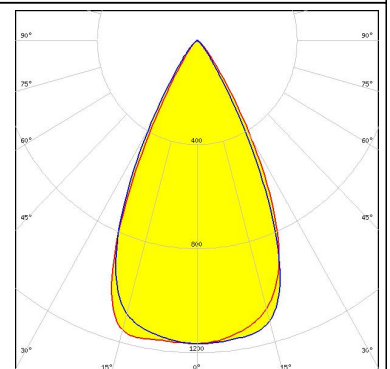
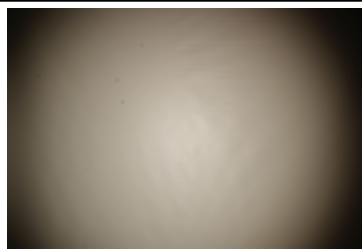

PHOTOMETRIC DATA (MEASURED):

CITIZEN

LED CLU7B2
 FWHM 53.0°
 Efficiency 86 %
 Peak intensity 1.210 cd/lm
 LEDs/each optic 1
 Light colour White
 Required components:

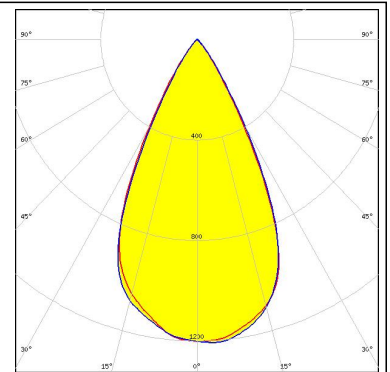

CITIZEN

LED LCN-C01B (Tunable White)
 FWHM 49.0°
 Efficiency 74 %
 Peak intensity 1.200 cd/lm
 LEDs/each optic 1
 Light colour White
 Required components:
 C16142_HEKLA-SOCKET-K

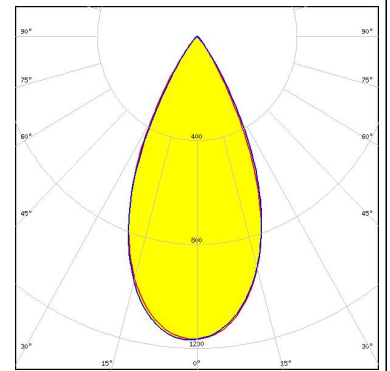
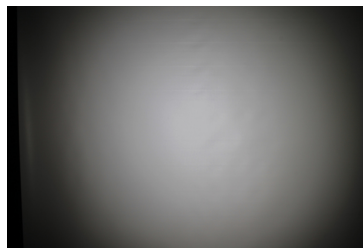

CREE

LED CMA1516
 FWHM 55.0°
 Efficiency 82 %
 Peak intensity 1.100 cd/lm
 LEDs/each optic 1
 Light colour White
 Required components:
 F15256_HEKLA-SOCKET-D

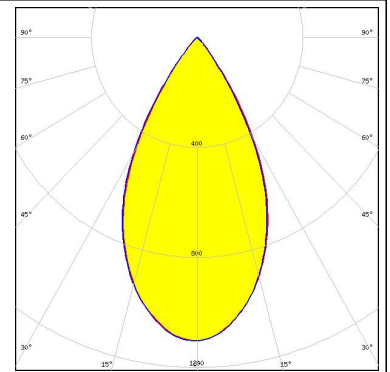
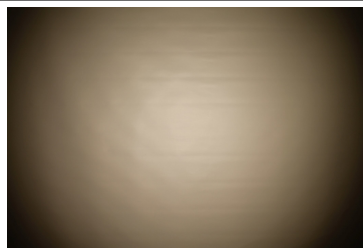

CREE

LED CMT14xx
 FWHM 45.0°
 Efficiency 75 %
 Peak intensity 1.300 cd/lm
 LEDs/each optic 1
 Light colour White
 Required components:
 F15255_HEKLA-SOCKET-C

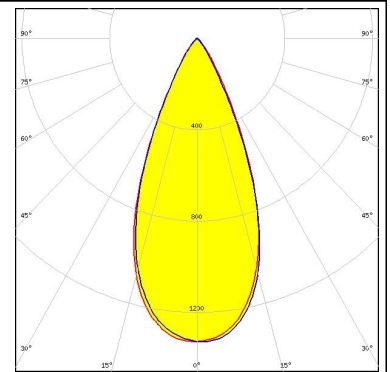
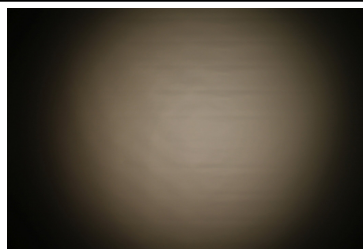

PHOTOMETRIC DATA (MEASURED):

LUMILEDS

LED LUXEON CoB 1202HD
 FWHM 52.0°
 Efficiency 82 %
 Peak intensity 1.200 cd/lm
 LEDs/each optic 1
 Light colour White
 Required components:
 F15848_HEKLA-SOCKET-G

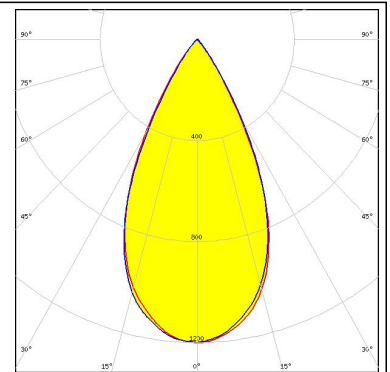

LUMILEDS

LED LUXEON CoB 1204HD
 FWHM 53.0°
 Efficiency 81 %
 Peak intensity 1.150 cd/lm
 LEDs/each optic 1
 Light colour White
 Required components:
 F15858_HEKLA-SOCKET-H

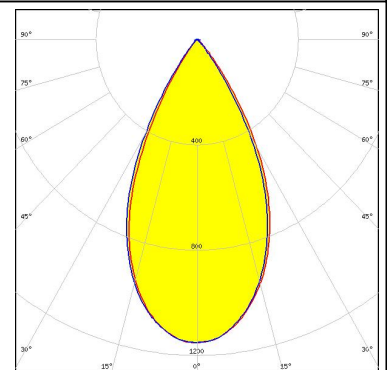
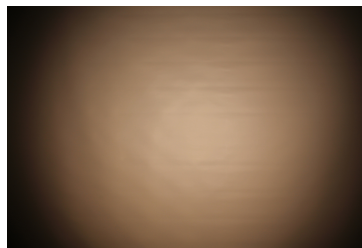

LUMILEDS

LED LUXEON CoB 1205HD
 FWHM 56.0°
 Efficiency 76 %
 Peak intensity 1.000 cd/lm
 LEDs/each optic 1
 Light colour White
 Required components:
 F15858_HEKLA-SOCKET-H

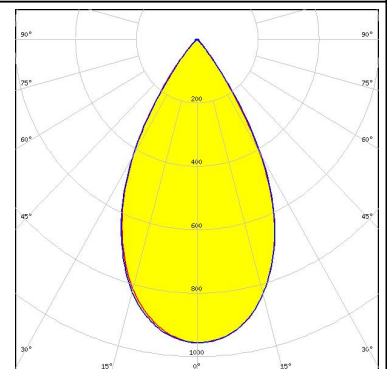

LUMINUS

LED CDM-6 (Dim-To-Warm)
 FWHM 51.0°
 Efficiency 78 %
 Peak intensity 1.200 cd/lm
 LEDs/each optic 1
 Light colour White
 Required components:
 C16142_HEKLA-SOCKET-K
 Bender Wirth: 490 Typ L8

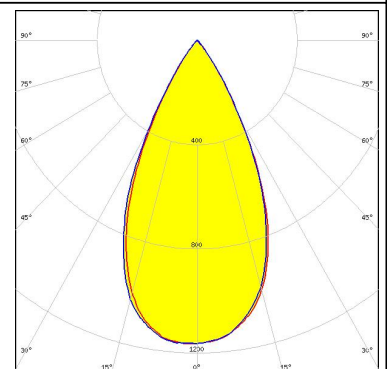
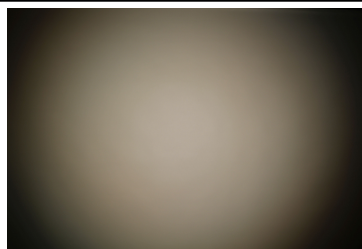

PHOTOMETRIC DATA (MEASURED):



LED CDM-9 (Dim-To-Warm)
 FWHM 53.0°
 Efficiency 77 %
 Peak intensity 1.100 cd/lm
 LEDs/each optic 1
 Light colour White
 Required components:
 C16142_HEKLA-SOCKET-K
 Bender Wirth: 490 Typ L8

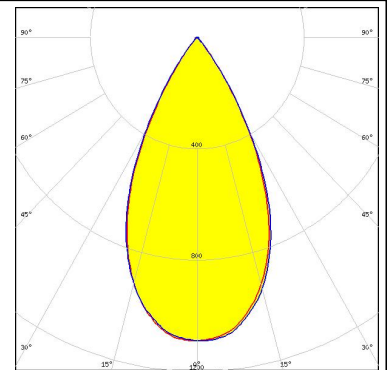

LED CTM-9 (Tunable White)
 FWHM 53.0°
 Efficiency 77 %
 Peak intensity 1.100 cd/lm
 LEDs/each optic 1
 Light colour White
 Required components:
 C16142_HEKLA-SOCKET-K
 Bender Wirth: 495 Typ L8

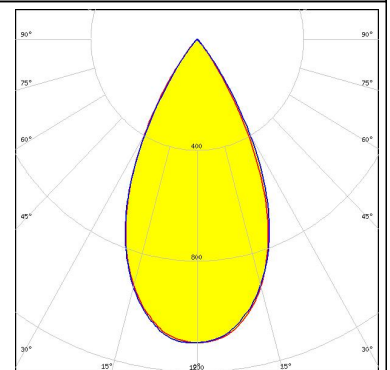
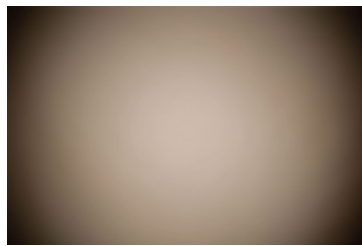

LED CXM-3
 FWHM 53.0°
 Efficiency 88 %
 Peak intensity 1.254 cd/lm
 LEDs/each optic 1
 Light colour White
 Required components:
 F15255_HEKLA-SOCKET-C

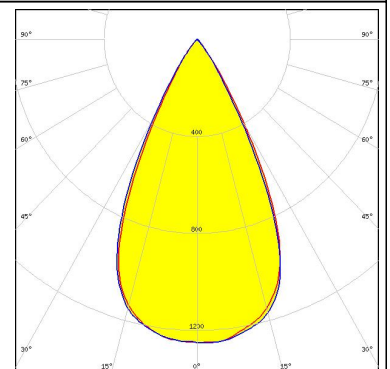
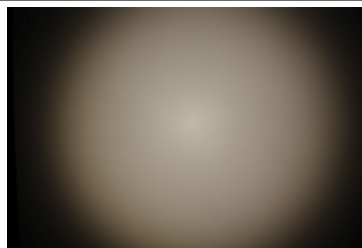

LED CXM-4
 FWHM 52.0°
 Efficiency 85 %
 Peak intensity 1.235 cd/lm
 LEDs/each optic 1
 Light colour White
 Required components:
 F15255_HEKLA-SOCKET-C

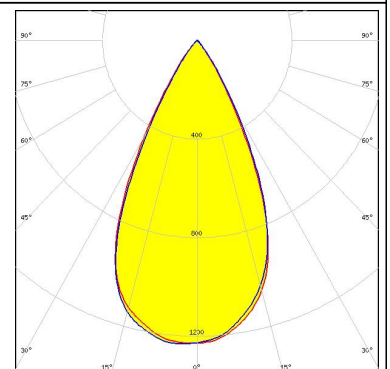
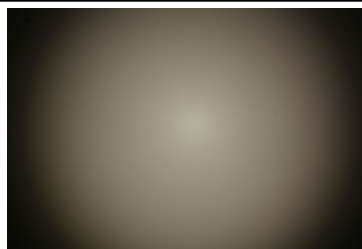

PHOTOMETRIC DATA (MEASURED):



LED CxM-9 (13.5x13.5)
 FWHM 53.0°
 Efficiency 81 %
 Peak intensity 1.100 cd/lm
 LEDs/each optic 1
 Light colour White
 Required components:
 F15255_HEKLA-SOCKET-C

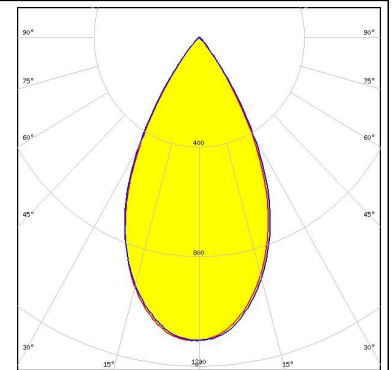
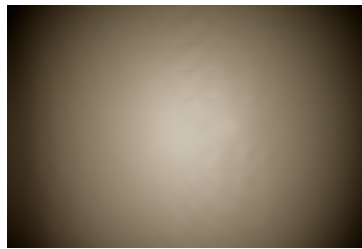

LED NJCWL024Z-V1MT: COB L-Type Tunable White
 FWHM 48.0°
 Efficiency 76 %
 Peak intensity 1.240 cd/lm
 LEDs/each optic 1
 Light colour White
 Required components:
 C16142_HEKLA-SOCKET-K
 Bender Wirth: 497 Typ L8

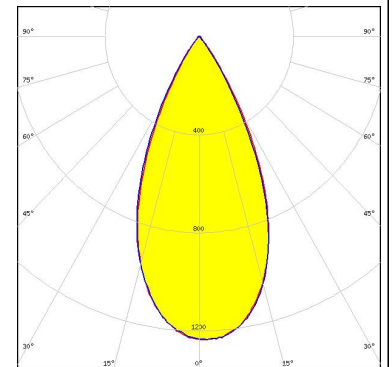

LED NVCWJ024Z-V1MT: COB J-Type Tunable White
 FWHM 53.0°
 Efficiency 74 %
 Peak intensity 1.000 cd/lm
 LEDs/each optic 1
 Light colour White
 Required components:
 C16142_HEKLA-SOCKET-K
 Bender Wirth: 498 Typ L8

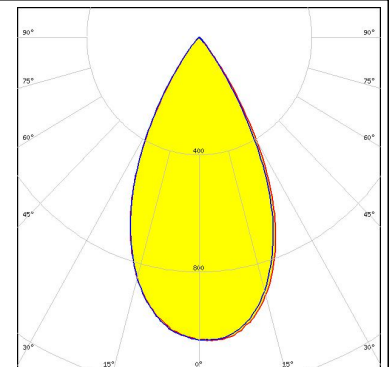

LED Fortimo SLM L09 CoB
 FWHM 54.0°
 Efficiency 81 %
 Peak intensity 1.130 cd/lm
 LEDs/each optic 1
 Light colour White
 Required components:
 F15858_HEKLA-SOCKET-H

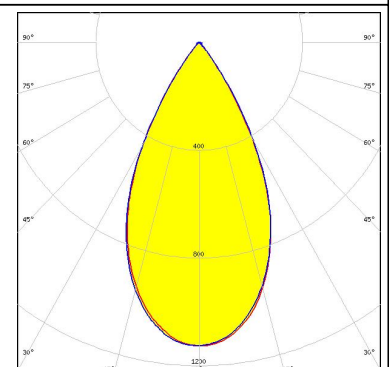
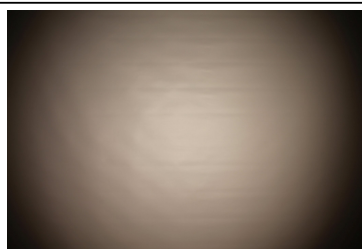

PHOTOMETRIC DATA (MEASURED):

SAMSUNG

LED COB D Series LES 9.8 mm
 FWHM 55.0°
 Efficiency 82 %
 Peak intensity 1.100 cd/lm
 LEDs/each optic 1
 Light colour White
 Required components:
 F15255_HEKLA-SOCKET-C

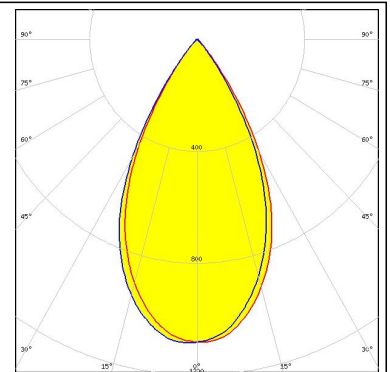

SAMSUNG

LED LC010C G2
 FWHM 52.0°
 Efficiency 84 %
 Peak intensity 1.200 cd/lm
 LEDs/each optic 1
 Light colour White
 Required components:
 F15255_HEKLA-SOCKET-C

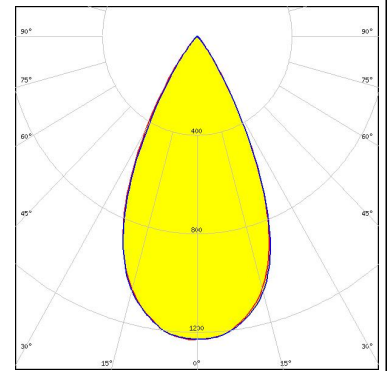
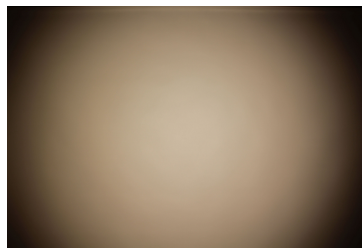

SAMSUNG

LED LC010T (Tunable White)
 FWHM 51.0°
 Efficiency 76 %
 Peak intensity 1.130 cd/lm
 LEDs/each optic 1
 Light colour Tunable White
 Required components:
 C16142_HEKLA-SOCKET-K
 Bender Wirth: 501 Typ L8

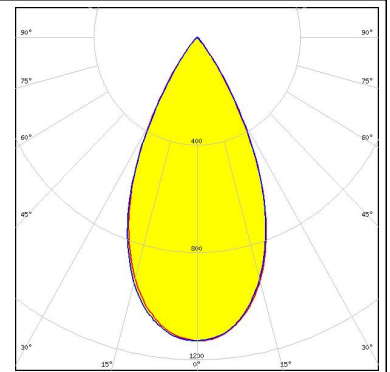
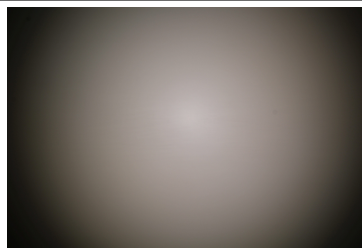



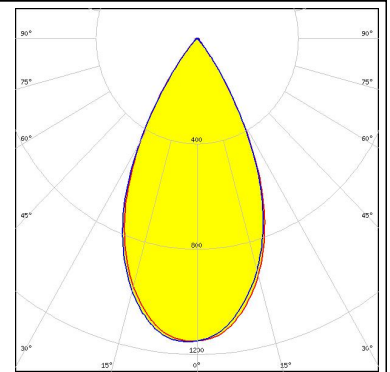
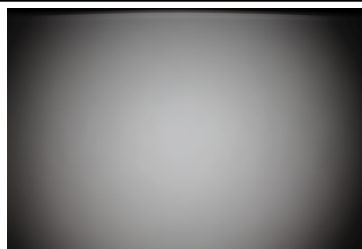

SAMSUNG

LED LC020C G2
 FWHM 52.0°
 Efficiency 80 %
 Peak intensity 1.200 cd/lm
 LEDs/each optic 1
 Light colour White
 Required components:
 F15859_HEKLA-SOCKET-I

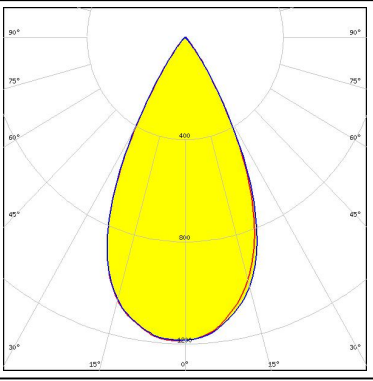
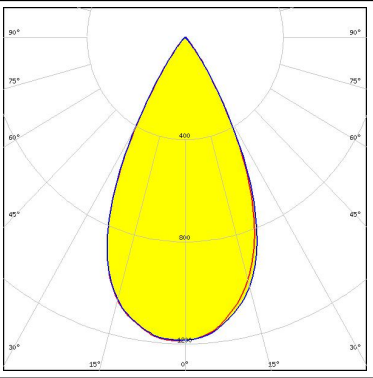
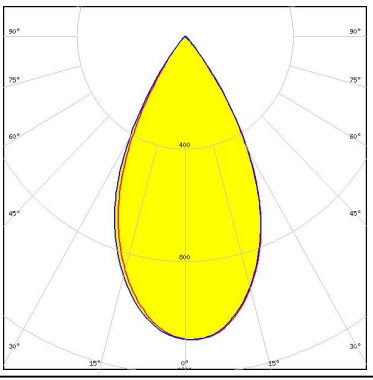

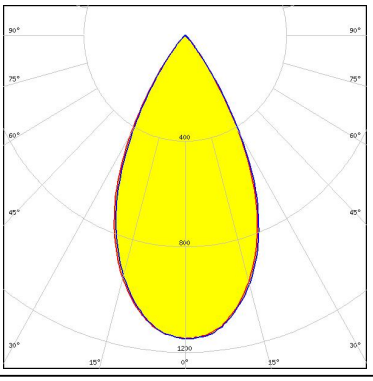
PHOTOMETRIC DATA (MEASURED):

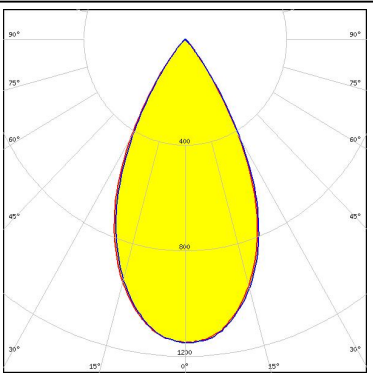
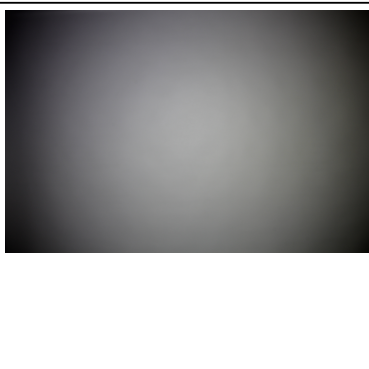
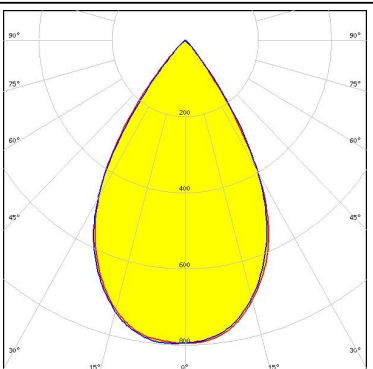
<p> SEUL SEMICONDUCTOR</p> <p>LED MJT COB LES 6 FWHM 52.0° Efficiency 82 % Peak intensity 1.200 cd/lm LEDs/each optic 1 Light colour White Required components: F15255_HEKLA-SOCKET-C</p>		
<p> SEUL SEMICONDUCTOR</p> <p>LED MJT COB LES 9.8 FWHM 54.0° Efficiency 79 % Peak intensity 1.100 cd/lm LEDs/each optic 1 Light colour White Required components: F15255_HEKLA-SOCKET-C</p>		
<p>TRIDONIC</p> <p>LED SLE G7 LES09 FWHM 53.0° Efficiency 83 % Peak intensity 1.100 cd/lm LEDs/each optic 1 Light colour White Required components: F15255_HEKLA-SOCKET-C</p>		
<p>TRIDONIC</p> <p>LED SLE G7 LES13 FWHM 63.0° Efficiency 74 % Peak intensity 0.800 cd/lm LEDs/each optic 1 Light colour White Required components: F15859_HEKLA-SOCKET-I</p>		

PHOTOMETRIC DATA (MEASURED):

XICATO

LED XOB 6 mm
FWHM 53.0°
Efficiency 83 %
Peak intensity 1.197 cd/lm
LEDs/each optic 1
Light colour White
Required components:
F15255_HEKLA-SOCKET-C

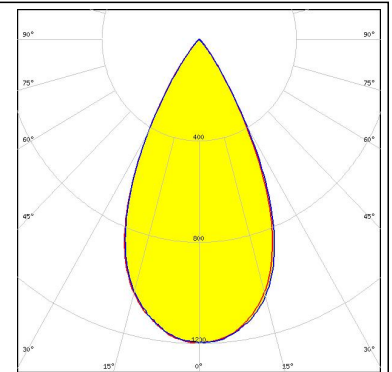
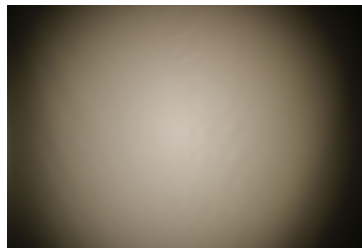

XICATO

LED XOB 9.8 mm
FWHM 53.0°
Efficiency 83 %
Peak intensity 1.144 cd/lm
LEDs/each optic 1
Light colour White
Required components:
F15255_HEKLA-SOCKET-C

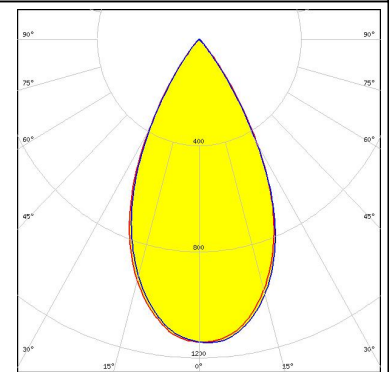
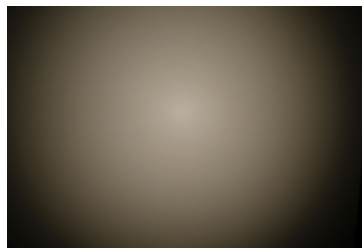



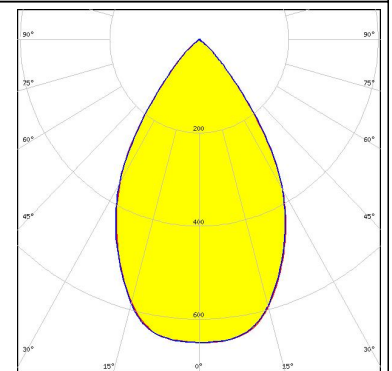
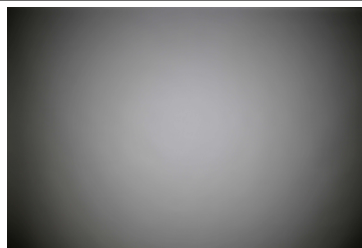

XICATO

LED XTM - 19mm LES
FWHM 64.0°
Efficiency 66 %
Peak intensity 0.650 cd/lm
LEDs/each optic 1
Light colour White
Required components:
C16058_XTM-ADAPTER-50-C

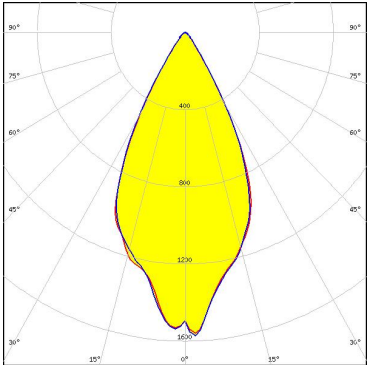
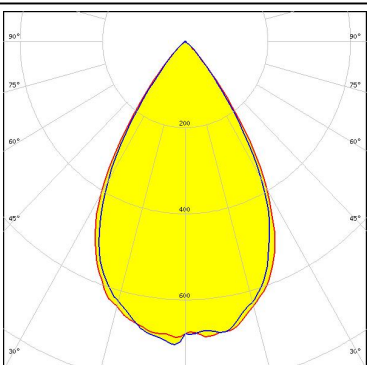

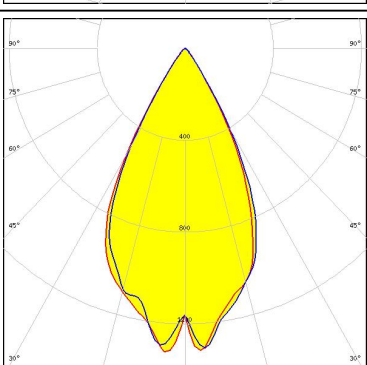
PHOTOMETRIC DATA (SIMULATED):

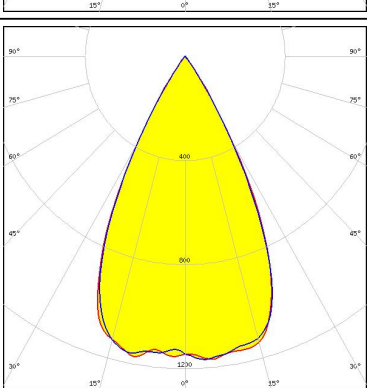
<p> bridgelux</p> <p>LED VERO10 FWHM 50.7° Efficiency 0 % Peak intensity 1.600 cd/lm LEDs/each optic 1 Light colour White Required components: F15616_HEKLA-SOCKET-F</p>	
<p>CITIZEN</p> <p>LED CLL03x/CLU03x FWHM 63.0° Efficiency 66 % Peak intensity 0.712 cd/lm LEDs/each optic 1 Light colour White Required components: F15859_HEKLA-SOCKET-I</p>	
<p> CREE</p> <p>LED CXA/B 15xx FWHM 53.5° Efficiency 0 % Peak intensity 1.365 cd/lm LEDs/each optic 1 Light colour White Required components: F15256_HEKLA-SOCKET-D</p>	
<p> NICHIA</p> <p>LED COB T-Type FWHM 54.0° Efficiency 84 % Peak intensity 1.200 cd/lm LEDs/each optic 1 Light colour White Required components: F15848_HEKLA-SOCKET-G</p>	

GENERAL INFORMATION:

NOTE: The typical beam angle will be changed by different color, chip size and chip position tolerance. The typical total beam angle is the full angle measured where the luminous intensity is half of the peak value.

Due to use of high power COB's with this product, special attention to proper thermal design is highly recommended. LEDiL has no liability for direct, indirect or consecutive damages arising from the LEDiL products being used outside of the recommended temperature range.

MATERIALS:

As part of our continuous research and improvement processes, and to ensure the best possible quality and availability of our products, LEDiL reserves the right to change material grades without notice.

PRODUCT DATA USER AGREEMENT AND DISCLAIMER:

The measured data in the provided downloadable LEDiL Product Datasheets and Mechanical 2D-Drawings is rounded and provided as reference for planning. LEDiL Oy's optical specifications have been verified by conducting performance testing of the products in accordance with the company's quality system. The reported data are averaged results of multiple measurements with typical variation. LEDiL Oy reserves the right to without prior notification make changes and improvements to its products.

LEDiL Oy assumes neither warranty, nor guarantee nor any other liability of any kind for the contents and correctness of the provided data. The provided data has been generated with highest diligence but the provided data may in reality not represent the complete possible variation range of all intrinsic parameters. Therefore, in certain cases a deviation from the provided data could occur.

LEDiL Oy reserves the right to undertake technical changes of its products without further notification which could lead to changes in the provided data. LEDiL Oy assumes no liability of any kind for the possible deviation from any provided data or any other damage resulting from the usage of the provided data.

The user agrees to this disclaimer and user agreement with the download or usage of the provided files.

LEDiL Oy

Joensuunkatu 13
FI-24240 SALO
Finland

LEDiL Inc.

228 West Page Street
Suite D
Sycamore IL 60178
USA

Local sales and technical support

[www.ledil.com/
where_to_buy](http://www.ledil.com/where_to_buy)

Shipping locations

Salo, Finland
Hong Kong, China

Distribution Partners

[www.ledil.com/
where_to_buy](http://www.ledil.com/where_to_buy)



Стандарт Электрон Связь

Мы молодая и активно развивающаяся компания в области поставок электронных компонентов. Мы поставляем электронные компоненты отечественного и импортного производства напрямую от производителей и с крупнейших складов мира.

Благодаря сотрудничеству с мировыми поставщиками мы осуществляем комплексные и плановые поставки широчайшего спектра электронных компонентов.

Собственная эффективная логистика и склад в обеспечивает надежную поставку продукции в точно указанные сроки по всей России.

Мы осуществляем техническую поддержку нашим клиентам и предпродажную проверку качества продукции. На все поставляемые продукты мы предоставляем гарантию .

Осуществляем поставки продукции под контролем ВП МО РФ на предприятия военно-промышленного комплекса России , а также работаем в рамках 275 ФЗ с открытием отдельных счетов в уполномоченном банке. Система менеджмента качества компании соответствует требованиям ГОСТ ISO 9001.

Минимальные сроки поставки, гибкие цены, неограниченный ассортимент и индивидуальный подход к клиентам являются основой для выстраивания долгосрочного и эффективного сотрудничества с предприятиями радиоэлектронной промышленности, предприятиями ВПК и научно-исследовательскими институтами России.

С нами вы становитесь еще успешнее!

Наши контакты:

Телефон: +7 812 627 14 35

Электронная почта: sales@st-electron.ru

Адрес: 198099, Санкт-Петербург,
Промышленная ул, дом № 19, литера Н,
помещение 100-Н Офис 331