

## General-purpose Limit Switch

# D4A-□□□N

## The Limit Switch with Better Seal, Shock Resistance, and Strength



- A double seal on the head, a complete gasket cover, and other features ensure a better seal (meets UL NEMA 3, 4, 4X, 6P, 12, 13).
- Wide standard operating temperature range:  
–40°C to +100°C (standard type).
- Models with fluoro-rubber available for greater resistance to chemicals.
- Block mounting method also reduces downtime for maintenance.
- DPDT, double-break models available for complex operations.
- Approved by UL, CSA, and CCC (Chinese standard).  
(Ask your OMRON representative for information on approved model.)



 Be sure to read *Safety Precautions* on page 14 to 15 and *Safety Precautions for All Limit Switches*.

## Model Number Structure

### Model Number Legend

**D4A-□□□□N (Set model number)**  
(1)(2) (3)

#### (1) Receptacle box

- 1 : 1/2-14 NPT conduit (SPDT, double-break)
- 2 : 1/2-14 NPT conduit (DPDT, double-break)
- 3 : G 1/2 conduit (SPDT, double-break)
- 4 : G 1/2 conduit (DPDT, double-break)

#### (2) Switch Box

- 1 : SPDT, double-break, without indicator
- 3 : SPDT, double-break, neon lamp
- E : SPDT, double-break, LED (24 VDC, leakage current: 1.3 mA)
- 5 : DPDT, double-break, simultaneous operation, without indicator
- 7 : DPDT, double-break, sequential operation, without indicator \*1
- 9 : DPDT, double-break, center neutral operation, without indicator \*2
- L : DPDT, double-break, simultaneous operation, neon lamp
- P : DPDT, double-break, simultaneous operation, LED

#### (3) Head

- 01 : Roller lever, standard
- 02 : Roller lever, high-sensitivity
- 03 : Roller lever, low torque
- 04 : Roller lever, high-sensitivity, low torque
- 05 : Roller lever, maintained
- 17 : Roller lever, sequential operation
- 18 : Roller lever, center neutral operation
- 06 : Side plunger, standard
- 07-V : Side plunger, vertical roller
- 07-H : Side plunger, horizontal roller
- 08 : Side plunger, adjustable
- 09 : Top plunger, standard
- 10 : Top plunger, roller
- 11 : Top plunger, adjustable
- 12 : Flexible rod, spring wire
- 14 : Flexible rod, plastic rod
- 15 : Flexible rod, cat whisker
- 16 : Flexible rod, coil spring

\*1. Use the D4A-0017N Special Head.

\*2. Use the D4A-0018N Special Head.

Note: Fluoro-rubber sealed type is also available.

## Ordering Information

Set model number

### SPDT, Double-break Switches

| Actuator        |                                 | Receptacle box<br>Indicator   | G 1/2 Conduit     |                    |                               |                    |                         |
|-----------------|---------------------------------|---|-------------------|--------------------|-------------------------------|--------------------|-------------------------|
|                 |                                 |   | Without indicator |                    | With neon lamp indicator (AC) |                    | With LED indicator (DC) |
|                 |                                 |   | Model             | Approved standards | Model                         | Approved standards | Model                   |
| Roller lever *1 | Standard                        |    | D4A-3101N         | UL, CSA            | D4A-3301N                     | UL, CSA            | D4A-3E01N               |
|                 | High-sensitivity                |    | D4A-3102N         | UL, CSA            | D4A-3302N                     | UL, CSA            | D4A-3E02N               |
|                 | Low-torque                      |    | D4A-3103N         | UL, CSA            | ---                           | ---                | ---                     |
|                 | High-sensitivity,<br>Low-torque |    | D4A-3104N         | UL, CSA            | D4A-3304N                     | UL, CSA            | ---                     |
|                 | Maintained *2                   |    | D4A-3105N         | UL, CSA            | D4A-3305N                     | UL, CSA            | D4A-3E05N               |
| Side plunger    | Standard                        |    | D4A-3106N         | UL, CSA            | ---                           | ---                | ---                     |
|                 | Vertical roller                 |    | D4A-3107-VN       | UL, CSA            | D4A-3307-VN                   | UL, CSA            | D4A-3E07-VN             |
|                 | Horizontal roller               |    | D4A-3107-HN       | UL, CSA            | D4A-3307-HN                   | UL, CSA            | ---                     |
|                 | Adjustable                      |    | D4A-3108N         | UL, CSA            | D4A-3308N                     | UL, CSA            | D4A-3E08N               |
| Top plunger     | Standard                        |    | D4A-3109N         | UL, CSA            | D4A-3309N                     | UL, CSA            | ---                     |
|                 | Roller                          |    | D4A-3110N         | UL, CSA            | D4A-3310N                     | UL, CSA            | ---                     |
|                 | Adjustable                      |   | D4A-3111N         | UL, CSA            | D4A-3311N                     | UL, CSA            | ---                     |
| Flexible rod    | Spring wire                     |  | D4A-3112N         | UL, CSA            | D4A-3312N                     | UL, CSA            | D4A-3E12N               |
|                 | Plastic rod                     |  | D4A-3114N         | UL, CSA            | D4A-3314N                     | UL, CSA            | D4A-3E14N               |
|                 | Cat whisker                     |  | D4A-3115N         | UL, CSA            | D4A-3315N                     | UL, CSA            | D4A-3E15N               |
|                 | Coil spring                     |  | D4A-3116N         | UL, CSA            | D4A-3316N                     | UL, CSA            | D4A-3E16N               |

Note: 1. Switches are also available with □1/2-14 NPT conduits. The model numbers correspond as follows:



















|                           |                     |
|---------------------------|---------------------|
| (Examples) G 1/2 Conduits | 1/2-14 NPT Conduits |
| D4A-3□□□N                 | D4A-1□□□N           |
| D4A-4□□□N                 | D4A-2□□□N           |

2. Switches are also available with fluoro-rubber seals for higher resistance to chemicals. (The operating temperature range for these Switches, however, is -10 to +120°C.) Add "-F" to the model number. (Example: D4A-3101N becomes D4A-3101N-F.) Ask your nearest OMRON representative for details.

\*1. The lever is not included with the Roller Level Models. Select the lever from those listed in this data sheet and order it separately (refer to Levers on page 12).

\*2. The Maintained Switches have a lock mechanism for the switch operation and thus use a Fork Lever Lock.

## DPDT, Double-break Switches

| Actuator        | Receptacle box<br>Indicator   | G 1/2 Conduit     |                    |                               |                         |
|-----------------|---|-------------------|--------------------|-------------------------------|-------------------------|
|                 |   | Without indicator |                    | With neon lamp indicator (AC) | With LED indicator (DC) |
|                 |   | Model             | Approved standards | Model                         | Model                   |
| Roller lever *1 | Standard                         | D4A-4501N         | UL, CSA            | D4A-4L01N                     | D4A-4P01N               |
|                 | High-sensitivity                 | D4A-4502N         | UL, CSA            | --                            | --                      |
|                 | Low-torque                       | D4A-4503N         | UL, CSA            | --                            | --                      |
|                 | High-sensitivity,<br>Low-torque  | D4A-4504N         | UL, CSA            | --                            | --                      |
|                 | Maintained *2                    | D4A-4505N         | UL, CSA            | --                            | --                      |
|                 | Sequential operation             | D4A-4717N         | UL, CSA            | --                            | --                      |
|                 | Center neutral<br>operation      | D4A-4918N         | UL, CSA            | --                            | --                      |
| Side plunger    | Standard                         | D4A-4506N         | UL, CSA            | --                            | --                      |
|                 | Vertical roller                  | D4A-4507-VN       | UL, CSA            | --                            | --                      |
|                 | Horizontal roller                | D4A-4507-HN       | UL, CSA            | --                            | --                      |
|                 | Adjustable                       | D4A-4508N         | UL, CSA            | --                            | --                      |
| Top plunger     | Standard                         | D4A-4509N         | UL, CSA            | --                            | --                      |
|                 | Roller                           | D4A-4510N         | UL, CSA            | D4A-4L10N                     | D4A-4P10N               |
|                 | Adjustable                       | D4A-4511N         | UL, CSA            | --                            | --                      |
| Flexible rod    | Spring wire                     | D4A-4512N         | UL, CSA            | --                            | --                      |
|                 | Plastic rod                    | D4A-4514N         | UL, CSA            | --                            | --                      |
|                 | Cat whisker                    | D4A-4515N         | UL, CSA            | --                            | --                      |
|                 | Coil spring                    | D4A-4516N         | UL, CSA            | --                            | --                      |

Note: 1. Switches are also available with □1/2-14 NPT conduits. The model numbers correspond as follows:

(Examples) G 1/2 Conduits      1/2-14 NPT Conduits  
 D4A-3□□□N      D4A-1□□□N  
 D4A-4□□□N      D4A-2□□□N



2. Switches are also available with fluoro-rubber seals for higher resistance to chemicals. (The operating temperature range for these Switches, however, is -10 to +120°C.) Add "-F" to the model number. (Example: D4A-4501N becomes D4A-4501N-F.) Ask your nearest OMRON representative about delivery times and prices.

\*1. The lever is not included with the Roller Level Models. Select the lever from those listed in this data sheet and order it separately (refer to Levers on page 12).

\*2. The Maintained Switches have a lock mechanism for the switch operation and thus use a Fork Lever Lock.

### Individual Parts

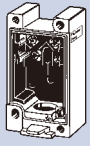
#### Receptacle box

|                   | Type<br>Appearance  | G1/2 conduit *1 |                    | 1/2-14NPT conduit *2 |                    |
|-------------------|---|-----------------|--------------------|----------------------|--------------------|
|                   |   | Model           | Approved standards | Model                | Approved standards |
| SPDT double-break |  | D4A-3000N       | UL, CSA            | D4A-1000N            | UL, CSA            |
| DPDT double-break |  | D4A-4000N       | UL, CSA            | D4A-2000N            | UL, CSA            |

\*1. M6-screw mounting  
(standard mounting)

\*2. 10-32UNF-screw mounting  
(standard mounting)

Switch Box

| Appearance        |   | Indicator                | Without indicator        |                    | With neon lamp indicator (AC) |                    | With LED indicator (DC) |
|-------------------|---|--------------------------|--------------------------|--------------------|-------------------------------|--------------------|-------------------------|
|                   |   |                          | Model                    | Approved standards | Model                         | Approved standards | Model                   |
| SPDT double-break |  | (Without indicator lamp) | D4A-0100N                | UL, CSA            | D4A-0300N                     | UL, CSA            | D4A-0E00N               |
|                   |   |                          | D4A-0500N                |                    | UL, CSA                       | D4A-0L00N          | ---                     |
| DPDT double-break |  | (Without indicator lamp) | Simultaneous operation   | D4A-0700N          | UL, CSA                       | ---                | ---                     |
|                   |   |                          | Sequential operation     | D4A-0900N          | UL, CSA                       | ---                | ---                     |
|                   |   |                          | Center neutral operation | ---                | ---                           | ---                | ---                     |

Heads

| Appearance      |   | Model                        | Approved standards |             |
|-----------------|---|------------------------------|--------------------|-------------|
| Roller lever *1 |    | Standard                     | D4A-0001N          |             |
|                 |   | High-sensitivity             | D4A-0002N          |             |
|                 |   | Low-torque *2                | D4A-0003N          |             |
|                 |   | Sequential operation: *3     | D4A-0017N          |             |
|                 |   | Center neutral operation: *3 | D4A-0018N          |             |
| Side plunger    |  | Maintained                   | D4A-0005N          |             |
|                 |   | Standard                     | D4A-0006N          |             |
|                 |   |                              | Vertical roller    | D4A-0007-VN |
|                 |   |                              | Horizontal roller  | D4A-0007-HN |
| Side adjustable |  | D4A-0008N                    | UL, CSA            |             |

\*1. Levers for Roller Lever Switches are optionally available. Select the lever from those listed in this data sheet and order (refer to Levers on page 12).  
 \*2. The D4A-C00 adjustable roller lever is too heavy and long for these heads and it should not be used or mechanical malfunction will result.  
 \*3. These heads cannot be used for double break operations.

| Appearance   | Type   | Model       | Approved standards |           |
|--------------|--|-------------|--------------------|-----------|
| Top plunger  |    | Standard    | D4A-0009N          |           |
|              |  | Roller      | D4A-0010N          |           |
|              |  | Adjustable  | D4A-0011N          |           |
| Flexible rod |  | Spring wire | D4A-0012N          |           |
|              |  | Plastic rod | D4A-0014N          |           |
|              |  |             | Cat whisker        | D4A-0015N |
|              |  |             | Coil spring        | D4A-0016N |

## Levers

| Actuator                | Model   |
|-------------------------|---------|
| Roller Lever            | D4A-A00 |
|                         | D4A-A10 |
|                         | D4A-A20 |
|                         | D4A-A30 |
|                         | D4A-B06 |
| Adjustable Roller Lever | D4A-C00 |
|                         | D4A-D00 |
| Resin Loop Lever        | D4A-F00 |
| Fork Lever Lock         | D4A-E30 |
|                         | D4A-E20 |
|                         | D4A-E10 |
|                         | D4A-E00 |

Note: Refer to page 12 for Lever shapes and applicable models.

## Specifications

## Approved Standards

| Agency    | Standard        | File No.         |
|-----------|-----------------|------------------|
| UL        | UL508           | E76675           |
| CSA       | CSA C22.2 No.14 | LR45746          |
| CCC (CQC) | GB14048.5       | 2003010305077615 |

Note: Ask your OMRON representative for information on approved models.

## Ratings

| Type                                       | Rated voltage | Non-inductive load (A) |     |           |     | Inductive load (A) |     |            |    |
|--|---------------|------------------------|-----|-----------|-----|--------------------|-----|------------|----|
|  |               | Resistive load         |     | Lamp load |     | Inductive load     |     | Motor load |    |
|  |               | NC                     | NO  | NC        | NO  | NC                 | NO  | NC         | NO |
| SPDT double-break (with/without indicator) | 125 VAC *     | 10                     | 10  | 3         | 1.5 | 10                 | 5   | 2.5        |    |
|  | 250 VAC *     | 10                     | 10  | 2         | 1   | 10                 | 3   | 1.5        |    |
|  | 480 VAC       | 10                     | 10  | 1.5       | 0.8 | 3                  | 1.5 | 0.8        |    |
|  | 600 VAC       | 3                      | 1   | 1         | 0.5 | 1.5                | 1   | 0.5        |    |
|  | 8 VDC         | 10                     |     | 6         | 3   | 10                 |     | 6          |    |
|  | 14 VDC        | 10                     |     | 6         | 3   | 10                 |     | 6          |    |
| DPDT double-break (without indicator)      | 30 VDC        | 6                      |     | 4         | 3   | 6                  |     | 4          |    |
|  | 125 VDC *     | 0.8                    |     | 0.2       | 0.2 | 0.8                |     | 0.2        |    |
|  | 250 VDC *     | 0.4                    |     | 0.1       | 0.1 | 0.4                |     | 0.1        |    |
|  | 125 VAC       | 5                      |     | 2         |     | 4                  |     | 3          |    |
| DPDT double-break (with indicator)         | 250 VAC       | 3                      |     | 1         |     | 2                  |     | 1.5        |    |
|  | 480 VAC       | 1.5                    |     | 0.5       |     | 1                  |     | 0.8        |    |
|  | 600 VAC       | 1                      |     | 0.4       |     | 0.7                |     | 0.5        |    |
|  | 14 VDC        | 5                      |     | 2         |     | 4                  |     | 3          |    |
|  | 30 VDC        | 3                      |     | 1         |     | 2                  |     | 1.5        |    |
| DPDT double-break (with indicator)         | 125 VDC       | 0.4                    |     | 0.1       |     | 0.4                |     | 0.1        |    |
|  | 250 VDC       | 0.2                    |     | 0.05      |     | 0.2                |     | 0.05       |    |
|  | 125 VAC       | 5                      |     | 2         |     | 4                  |     | 3          |    |
| DPDT double-break (with indicator)         | 250 VAC       | 3                      |     | 1         |     | 2                  |     | 1.5        |    |
|  | 12 VDC        | 5                      |     |           |     |                    |     |            |    |
|  | 24 VDC        | 3                      | --- | ---       |     | ---                |     | ---        |    |
| DPDT double-break (with indicator)         | 48 VDC        | 1                      |     |           |     |                    |     |            |    |

\* For those with indicators, refer to the following rated voltages.

| Item           | Type            | SPDT, Double-break |                | DPDT, Double-break |                |
|----------------|-----------------|--------------------|----------------|--------------------|----------------|
|                |                 | Without indicator  | With indicator | Without indicator  | With indicator |
| Inrush current | Normally closed | 30 A max.          |                |                    |                |
|                | Normally open   | 20 A max.          |                |                    |                |

- Note: 1. The above current ratings are for steady-state current.  
 2. Inductive loads have a power factor of 0.4 min. (AC) and a time constant of 7 ms max. (DC).  
 3. Lamp loads have an inrush current of 10 times the steady-state current.  
 4. Motor loads have an inrush current of 6 times the steady-state current.

## Ratings for Models with Indicators and Indicator Replacement

## Ratings for Indicators

| Classification    | Indicator | Model     | Rated voltage    | Leakage current | Internal resistance |
|-------------------|-----------|-----------|------------------|-----------------|---------------------|
| SPDT double-break | Neon lamp | D4A-0300N | 125 VAC, 250 VAC | Approx. 0.47 mA | 150 kΩ              |
|                   | LED       | D4A-0E00N | 24 VDC           | Approx. 1.3 mA  | 15 kΩ               |
| DPDT double-break | Neon lamp | D4A-0L00N | 125 VAC, 250 VAC | Approx. 0.28 mA | 240 kΩ              |
|                   | LED       | D4A-0P00N | 48 VDC           | Approx. 1.4 mA  | ---                 |

## Approved Standard Ratings

## UL/CSA

## A600

## D4A-□1□□N (SPDT, Double-break, Without Indicator)

| Rated voltage | Carry current | Current (A) |       | Volt-amperes (VA) |       |
|---------------|---------------|-------------|-------|-------------------|-------|
|               |               | Make        | Break | Make              | Break |
| 120 VAC       | 10 A          | 60          | 6     | 7,200             | 720   |
| 240 VAC       |               | 30          | 3     |                   |       |
| 480 VAC       |               | 15          | 1.5   |                   |       |
| 600 VAC       |               | 12          | 1.2   |                   |       |

## A300

## D4A-□3□□N (SPDT, Double-break, With Neon Lamp)

| Rated voltage | Carry current | Current (A) |       | Volt-amperes (VA) |       |
|---------------|---------------|-------------|-------|-------------------|-------|
|               |               | Make        | Break | Make              | Break |
| 120 VAC       | 10 A          | 60          | 6     | 7,200             | 720   |
| 240 VAC       |               | 30          | 3     |                   |       |

## B600

## D4A-□5□□N (DPDT, Double-break, Simultaneous Operation)

## D4A-□7□□N (DPDT, Double-break, Sequential Operation)

## D4A-□9□□N (DPDT, Double-break, Center Neutral Operation)

| Rated voltage | Carry current | Current (A) |       | Volt-amperes (VA) |       |
|---------------|---------------|-------------|-------|-------------------|-------|
|               |               | Make        | Break | Make              | Break |
| 120 VAC       | 5 A           | 30          | 3     | 3,600             | 360   |
| 240 VAC       |               | 15          | 1.5   |                   |       |
| 480 VAC       |               | 7.5         | 0.75  |                   |       |
| 600 VAC       |               | 6.0         | 0.6   |                   |       |

## CCC (GB14048.5)

| Applicable category and ratings |
|---------------------------------|
| AC-15 2 A/125 VAC               |

## Characteristics

|  |   |   |  |
|--|---|---|--|
| Degree of protection (reference standards) |   | IP67 and NEMA 1, 2, 3, 4X, 5, 6P, 12, and 13  |  |
| Durability *2                              | Mechanical: *1  | SPDT, double-break, roller lever: 50,000,000 operations min.<br>DPDT, double-break, roller lever: 30,000,000 operations min.  |  |
|  | Electrical:   | SPDT, double-break: for 125 VAC, 10 A resistive load: 1,000,000 operations min.<br>DPDT, double-break: for 125 VAC, 5 A resistive load: 750,000 operations min.                         |  |
| Operating speed                            |   | 1 mm/s to 2 m/s (in case of D4A-3101N roller lever model)   |  |
| Operating frequency                        | Mechanical:   | 300 operations/minute   |  |
|  | Electrical:   | 30 operations/minute  |  |
| Rated frequency                            |   | 50/60 Hz  |  |
| Insulation resistance                      |   | 100 M $\Omega$ min. (at 500 VDC) between terminals of the same polarity, between current-carrying metal parts and ground, and between each terminal and non-current-carrying metal part |  |
| Contact resistance                         |   | 25 m $\Omega$ max. (initial value)  |  |
| Temperature rise                           |   | 50°C max.   |  |
| Dielectric strength                        | Between terminals of same polarity                        | 1,000 VAC, 50/60 Hz for 1 min.  |  |
|  | Between current-carrying metal parts and ground           | 2,200 VAC, 50/60 Hz for 1 min. *3   |  |
|  | Between each terminal and non-current-carrying metal part | 2,200 VAC, 50/60 Hz for 1 min. *3   |  |
| Pollution degree (operating environment)   |   | 3   |  |
| Protection against electric shock          |   | Class I (with grounding terminal)   |  |
| Vibration resistance                       | Malfunction: *4   | 10 to 55 Hz, 1.5-mm double amplitude  |  |
|  | Destruction:  | 1,000 m/s <sup>2</sup> min.   |  |
| Shock resistance                           | Malfunction: *4   | SPDT, double-break, roller lever: 600 m/s <sup>2</sup> min.<br>DPDT, double-break, roller lever: 300 m/s <sup>2</sup> min.  |  |
|  |   | Ambient operating humidity  |  |
| Ambient operating humidity                 |   | 35% to 95%RH (with no icing)  |  |
| Weight                                     |   | Approx. 290 g (in case of D4A-3101N )   |  |

Note: The above figures are initial values.

\*1. Excluding maintained models.

\*2. The values are calculated at an operating temperature of +5°C to +35°C, and an operating humidity of 40% to 70%RH. Contact your OMRON sales representative for more detailed information on other operating environments.

\*3. 1,500 VAC is applied to the indicator lamp type.

\*4. Not including Flexible rods (cat whisker, plastic rod, coil spring, and spring wire types).

| Item                | Type | Roller lever *1 | Plunger, flexible rod *2 | With indicator |
|---------------------|------|-----------------|--------------------------|----------------|
| Ambient temperature |      | -40°C to +100°C | -20°C to +100°C          | -10°C to +80°C |

\*1. Excluding low-torque and high-sensitivity models.

\*2. Including roller lever low-torque and high-sensitivity operating models.

## Engineering Data

**Electrical Durability (SPDT Double-break)** (Ambient temperature: +5°C to +35°C; ambient humidity: 40% to 70%RH)



**Electrical Durability (DPDT Double-break)**



## Structure and Nomenclature

### Structure (DPDT Double-break)

#### Head

With the Roller Lever and Side Plunger Switches, the direction of the switch head can be varied to any of the four directions by loosening the roller lever switch screws at the four corners of the head.

The Roller Lever Switch employs a system which allows selection of the operation of only one side (left or right) or both sides without use of any tools.

**Operating Position Mark (arrow)**

#### Bearings

The copper-alloy bearings ensure long life expectancy.

#### Receptacle

The plug-in type receptacle provides adequate space for wiring.

#### Conduit Opening \*1, \*2

G 1/2 conduit threads featuring high sealing property are used. (Consult your OMRON representative for details on SC connectors). A terminal box with 1/2-14NPT conduit threads is also available on request.

#### Sealed Gasket

The employed full-cover method prevents the gasket from direct exposure to oil or water spray.

#### Roller

The roller actuator is made of hardened stainless steel and excels in resistance to wear.

#### Lever

With the Roller Lever Switch, the lever can be installed anywhere in a 360° range (180° if the lever is reversed and attached to the shaft).

#### Oil Seal

Improved sealing property is ensured with a double-seal construction (a oil seal plus an X-ring seal).

#### Switch Box

Boasts long life expectancy (50 million mechanical operations or more with the 2-pole Double-break Switches and 30 million mechanical operations or more with the DPDT Double-break Switches).

#### Ground Terminal Screw

A ground terminal is provided to enhance safety.

#### Switch Box Screw

A Phillips screw is used to secure the switch housing for ease of use, and features a measure to prevent the screw from coming off.

### Easy-maintenance Block Mounting

Block mounting makes it possible to easily assemble or disassemble the head, switch body, and receptacle of the D4A-□N by tightening or loosening the attached screws.



Note: 1. NBR is used in rubber components.

Fluoro-rubber sealed types use fluoro-rubber.

2. For Roller Levers, there is some lever play in the free position (about 2 mm), but this is due to the structure of the head and does not interfere with performance.

\*1. A Receptacle and Terminal Box with 1/2-14NPT conduit threads are also available for the North America market.

\*2. The conduit thread indication has been changed from "PF1/2" to "G1/2" accompanying the JIS B 0202 revision.

This changes applies only to the indication; thread sizes and pitches have not been affected.

**Contact Forms (Switch Boxes)  
STDP Double-break Switches**

| Type                | Contact model     |  |  | Operating pattern |
|---------------------|-------------------|--|--|-------------------|
|                     | Without indicator | With neon lamp indicator *             | With LED indicator *                   |                   |
| 1NC/1NO snap-action | D4A-0100N<br>     | D4A-0300N<br>                          | D4A-0E00N<br>                          |                   |
|                     |                   | <b>Lamp Unit Internal Circuits</b><br> | <b>Lamp Unit Internal Circuits</b><br> |                   |

\* Switches with indicators are factory-set to light when the switch is not operated.

**DTDP Double-break Switches**

Each of these Switches can be used to replace two limit switches in applications, such as high-speed control in machine tools and switching motors between forward and reverse, that previously required 2 limit switches. This simplifies wiring, saves space, and reduces costs.

| Type   | Contact model     |                            |                      | Operating pattern | Remarks   |
|--|-------------------|----------------------------|----------------------|-------------------|---|
|  | Without indicator | With neon lamp indicator * | With LED indicator * |                   |   |
| 2NC/2NO snap-action, simultaneous operation                  | D4A-0500N         | D4A-0L00N                  | D4A-0P00N            |                   | Head is compatible with double-break head. Can be switched for operation on both sides of actuator. |
| 2NC/2NO snap-action, sequential operation (2-step operation) | D4A-0700N         | ---                        | ---                  |                   | Use the D4A-0017N Special Head.   |
| 2NC/2NO snap-action, central neutral operation               | D4A-0900N         | ---                        | ---                  |                   | Use the D4A-0018N Special Head.   |

| Item                       | Without indicator                       | With neon lamp indicator * | With LED indicator * |
|----------------------------|---|----------------------------|----------------------|
| Contact form               | D4A-0500N<br>D4A-0700N<br>D4A-0900N<br> | D4A-0L00N<br>              | D4A-0P00N<br>        |
| Lamp unit internal circuit | ---                                     |                            |                      |

\* Switches with indicators are factory-set to light when the switch is not operated, but the setting can be changed to light for operation (dotted lines).



## Dimensions and Operating Characteristics

(Unit: mm)

### Set Model Numbers

(The box in a model number indicates the switch box type.)

**Roller Lever Switches Note: Levers of the side rotary type are optionally available.**

#### Standard

D4A-3□01N, D4A-4□01N

#### High-sensitivity

D4A-3□02N, D4A-4□02N

#### Low-torque

D4A-3□03N, D4A-4□03N

#### High-sensitivity/ Lowtorque

D4A-3□04N, D4A-4□04N

#### Sequential Operation

D4A-4□17N

#### Center Neutral Operating

D4A-4□18N



#### Maintained

D4A-3□05N, D4A-4□05N



Note: Unless otherwise specified, a tolerance of ±0.4 mm applies to all dimensions.

| Operating characteristics | Model   | SPDT Double-break |           |           |           |           | DPDT Double-break |           |           |           |           |  |           |
|---------------------------|---------|-------------------|-----------|-----------|-----------|-----------|-------------------|-----------|-----------|-----------|-----------|--|-----------|
|                           |         | D4A-3□01N         | D4A-3□02N | D4A-3□03N | D4A-3□04N | D4A-3□05N | D4A-4□01N         | D4A-4□02N | D4A-4□03N | D4A-4□04N | D4A-4□05N | D4A-4□17N                                      | D4A-4□18N |
| Operating force           | OF max. | 0.39 N·m          | 0.39 N·m  | 0.2 N·m   | 0.2 N·m   | 0.39 N·m  | 0.39 N·m          | 0.39 N·m  | 0.2 N·m   | 0.2 N·m   | 0.39 N·m  | 0.39 N·m                                       | 0.39 N·m  |
| Release force             | RF min. | 0.05 N·m          | 0.05 N·m  | ---       | ---       | ---       | 0.05 N·m          | 0.05 N·m  | ---       | ---       | ---       | 0.05 N·m                                       | 0.02 N·m  |
| Pretravel                 | PT max. | 15° (12°)         | 7° (6°)   | 15° (12°) | 7° (6°)   | 65° (60°) | 15° (12°)         | 7° (6°)   | 15° (12°) | 7° (6°)   | 65° (60°) | 1-stage:<br>12° (10°)<br>2-stage:<br>20° (17°) | 19° (15°) |
| Overtravel                | OT min. | 70°               | 75°       | 70°       | 75°       | 20°       | 70°               | 75°       | 70°       | 75°       | 20°       | 65°  | 65°       |
| Movement Differential     | MD max. | 5° (4°)           | 4° (3°)   | 5° (4°)   | 4° (3°)   | 35° (30°) | 7° (6°)           | 5° (4°)   | 7° (6°)   | 5° (4°)   | 35° (30°) | 6° (5°)  | 5° (4°)   |

Note: The figures in the parentheses are average values.

## Side Plunger Switches

### Standard

D4A-3□06N  
D4A-4□06N



### Horizontal Roller

D4A-3□07-HN  
D4A-4□07-HN



### Vertical Roller

D4A-3□07-VN  
D4A-4□07-VN



### Adjustable

D4A-3□08N  
D4A-4□08N



| Model                 | SPDT Double-break |             |             |           | DPDT Double-break |             |             |           |
|-----------------------|-------------------|-------------|-------------|-----------|-------------------|-------------|-------------|-----------|
|                       | D4A-3□06N         | D4A-3□07-HN | D4A-3□07-VN | D4A-3□08N | D4A-4□06N         | D4A-4□07-HN | D4A-4□07-VN | D4A-4□08N |
| Operating force       | OF max.           | 19.61 N     | 19.61 N     | 19.61 N   | 19.61 N           | 19.61 N     | 19.61 N     | 19.61 N   |
| Release force         | RF min.           | 4.90 N      | 4.90 N      | 4.90 N    | 4.90 N            | 4.90 N      | 4.90 N      | 4.90 N    |
| Pretravel             | PT max.           | 2.4 mm      | 2.4 mm      | 2.4 mm    | 2.4 mm            | 2.4 mm      | 2.4 mm      | 2.4 mm    |
| Overtavel             | OT min.           | 5.1 mm      | 5.1 mm      | 5.1 mm    | 5.1 mm            | 5.1 mm      | 5.1 mm      | 5.1 mm    |
| Movement Differential | MD max.           | 0.6 mm      | 0.6 mm      | 0.6 mm    | 0.6 mm            | 1.0 mm      | 1.0 mm      | 1.0 mm    |
| OP *                  |                   | 34±0.8 mm   | 44±0.8 mm   | 44±0.8 mm | 41 to 47.5 mm     | 34±0.8 mm   | 44±0.8 mm   | 44±0.8 mm |

\* Operating position

## Top Plunger Switches

### Standard

D4A-3□09N  
D4A-4□09N



### Roller Plunger

D4A-3□10N  
D4A-4□10N



### Adjustable

D4A-3□11N  
D4A-4□11N



| Model                 | SPDT double-break |           |           | DPDT double-break |           |           |
|-----------------------|-------------------|-----------|-----------|-------------------|-----------|-----------|
|                       | D4A-3□09N         | D4A-3□10N | D4A-3□11N | D4A-4□09N         | D4A-4□10N | D4A-4□11N |
| Operating force       | OF max.           | 17.65 N   | 17.65 N   | 17.65 N           | 17.65 N   | 17.65 N   |
| Release force         | RF min.           | 4.90 N    | 4.90 N    | 4.90 N            | 4.90 N    | 4.90 N    |
| Pretravel             | PT max.           | 1.6 mm    | 1.6 mm    | 1.6 mm            | 1.6 mm    | 1.6 mm    |
| Overtavel             | OT min.           | 5.1 mm    | 5.1 mm    | 5.1 mm            | 5.1 mm    | 5.1 mm    |
| Movement Differential | MD max.           | 0.4 mm    | 0.4 mm    | 1.0 mm            | 1.0 mm    | 1.0 mm    |
| OP *                  |                   | 46±0.8 mm | 56±0.8 mm | 55.5 to 62 mm     | 46±0.8 mm | 56±0.8 mm |

\* Operating position

Note: A Fork Lever Lock can be used with D4A-□□05N models only.

Flexible Rod

Spring wire  
D4A-3□12N  
D4A-4□12N



Plastic Rod  
D4A-3□14N  
D4A-4□14N



Cat Whisker  
D4A-3□15N  
D4A-4□15N



Coil Spring  
D4A-3□16N  
D4A-4□16N



Note: Unless otherwise specified, a tolerance of ±0.4 mm applies to all dimensions.

| Model                   | SPDT Double-break |           |           |           | DPDT Double-break |           |           |           |
|-------------------------|-------------------|-----------|-----------|-----------|-------------------|-----------|-----------|-----------|
|                         | D4A-3□12N         | D4A-3□14N | D4A-3□15N | D4A-3□16N | D4A-4□12N         | D4A-4□14N | D4A-4□15N | D4A-4□16N |
| Operating force OF max. | 0.98 N            |           | 1.47 N    |           | 0.98 N            |           | 1.47 N    |           |
| Pretravel PT max.       | 15° (5°)          |           | 15° (5°)  |           | 15° (5°)          |           | 15° (5°)  |           |

Note: The figures in the parentheses are average values.

## Levers (for Roller Lever Switches)

Note: No D4A-0003N or D4A-0004N head should be used with the adjustable roller lever or mechanical malfunctioning could result because the total weight of the adjustable roller lever is comparatively large. Use a standard-load head (D4A-0001N or D4A-0002N) instead.

**Roller Lever  
D4A-A00**



**Roller Lever  
D4A-B06**



**Fork Lever Lock  
D4A-E30**



**Roller Lever  
D4A-A10**



**Adjustable Roller Lever  
D4A-C00**



**Fork Lever Lock  
D4A-E20**



**Roller Lever  
D4A-A20**



**Adjustable Rod Lever  
D4A-D00**



**Fork Lever Lock  
D4A-E10**



**Roller Lever  
D4A-A30**



**Fork Lever Lock  
D4A-E00**



**Nylon Loop Lever  
D4A-F00**



Note: Unless otherwise specified, a tolerance of  $\pm 0.4$  mm applies to all dimensions.

**Head and Lever Positions**

- The operating head can be positioned and locked in any of four 90° positions and a lever can lock in any position through 360° around the shaft of the Limit Switch. Furthermore, the lever can be reversed and attached to the shaft (refer to the figures below on the right hand side). Therefore the roller is compatible with a wide movement range of a dog.
- A Fork Lever Lock can be used with maintained models (D4A-0005N) only.

Remove the head from the Switch by loosening the screws (the screws can be loosened but not removed from the head).

Four, M4 x 12

The operating head can be positioned and locked in any of four 90° positions.

The lever can lock in any position through 360° around the shaft. The lever can be reversed and attached to the shaft, in which case the switching operation should complete in a range of 0° to 180°.

There are four kinds of fork lever locks. The position of each roller is different. It is possible to use D4A-E00 through D4A-E30 levers instead, if they are reversed before attaching. They can be used with D4A-□□05N models only.

D4A-E00

D4A-E10

D4A-E20

D4A-E30

By loosening the Allen-head bolt on an adjustable roller lever or rod lever, the length of the lever can be adjusted.

D4A-C00

D4A-D00 Loosen the bolt to adjust the length of the lever.  
Adjustable between 33 and 91 mm

D4A-D00

Loosen the screw to adjust the length of the rod.

**Lever Position**

**D4A-A00**

**D4A-A10**

**D4A-A20**

**D4A-A30**

**Nameplate**

1U

OMRON D4A- ← The whole switch model without lever is printed.

NEMA A600 TYPE 3, 4, 4X, 6P and 13 IND. CONT. EQ.

4 3 NO  
1 2 NC

UL LISTED 782Y

MUST BE SAME POLARITY

2A 125VAC SWITCH BODY ONLY D4A-010N ← The type of switch box is printed. (The type is also indicated on the head and receptacle.)

A014179 083424 MADE IN JAPAN

When ordering, do not confuse set model numbers and model numbers for individual blocks.

**Compatibility with D4A-□**

The D4A-□N is compatible with the D4A-□ when the following accessories are attached to the D4A-□N.

+
+

D4A-□  
Receptacle box

D4A-□N  
Switch box

D4A-□N  
Head

The D4A-□N without the above accessories is not compatible with the D4A-□.

## Safety Precautions

For details, be sure to read *Safety Precautions for All Limit Switches*.

### Precautions for Correct Use

#### Operating Environment

- Seal material may deteriorate if a Switch is used outdoor or where subject to special cutting oils, solvents, or chemicals. Always appraise performance under actual application conditions and set suitable maintenance and replacement periods.
- Install Switches where they will not be directly subject to cutting chips, dust, or dirt. The Actuator and Switch must also be protected from the accumulation of cutting chips or sludge.



- Constantly subjecting a Switch to vibration or shock can result in wear, which can lead to contact interference with contacts, operation failure, reduced durability, and other problems. Excessive vibration or shock can lead to false contact operation or damage. Install Switches in locations not subject to shock and vibration and in orientations that will not produce resonance.
- The Switches have physical contacts. Using them in environments containing silicon gas will result in the formation of silicon oxide (SiO<sub>2</sub>) due to arc energy. If silicon oxide accumulates on the contacts, contact interference can occur. If silicon oil, silicon filling agents, silicon cables, or other silicon products are present near the Switch, suppress arcing with contact protective circuits (surge killers) or remove the source of silicon gas.

#### Changing the Operating Direction

##### Roller Lever Switch

The head of the side rotary type can be converted in seconds to CW, CCW, or both-way operation. Follow the procedures on the right hand side for conversion (not applicable to the Maintained, Sequential Operating, Center Neutral Operating Switches).

| Operating Part (Rear of Head) | Procedures   |
|-------------------------------|--|
|                               | <ol style="list-style-type: none"> <li>Dismount the head by loosening the four screws that secure it.</li> <li>Turn over the head to set the desired operation (CW, CCW, or both). The desired side can be selected by setting the mode selector knob shown in the figure. This knob is factory set to the "CW+CCW" (both-way operation) position.</li> <li>When set to the CW position, the head rotates in clockwise direction. When set to the CCW position, the head rotates in counterclockwise direction. In either case, be sure to accurately align the arrow mark to the setting position.</li> </ol> |

#### Lighting Mode Selection of Indicators (SPDT only)

The lighting mode of the operation indicator can be changed easily between two modes: lighting when the Switch is operating and lighting when the Switch is not operating.

| Lights When Not Operating *1 | Lights When Operating *2 |
|------------------------------|--------------------------|
|                              |                          |
|                              |                          |

- \*1. The lamp is lit when the actuator is at the free position. The lamp will be off when the contacts of the Limit Switch have been actuated and snapped to each other at the operating position.
- \*2. The lamp is lit when the contacts have been released and snapped only from the operating position.

Change the lighting mode as follows:

- Push the claw securing the lamp section to the right (do not push strongly).
- Remove the lamp section.
- Mount the lamp section so that legend "NC-ON" or "NO-ON" will appear in the display window.



In either case, the lamp will not light when the load is ON.

#### Mounting

| Model                     | G1/2 Conduit |          |
|---------------------------|--------------|----------|
|                           | D4A-3□□N     | D4A-4□□N |
| Front Mounting            |              |          |
| Rear Mounting (Rear View) |              |          |

## Screw Tightening Torques for Heads and Switch Boxes

To maintain the high sealing capability of the Limit Switch, tighten the screws for the head and switch box with the following torques:

Head (four 12-mm M4 screws): 1.2 to 1.4 N-m

Switch box (two 20-mm M5 screws): 2.4 to 2.7 N-m

## Solderless Terminals

The D4A-□N with DPDT double-break incorporates solderless terminals.

## Operation

- The operating methods, cam and dog shapes, operating frequency, and overtravel (OT) have a significant effect on the service life and accuracy of the Limit Switch. The shape of the cam should be as smooth as possible.
- A marginal overtravel (OT) value should be set. The ideal value is the rated OT value x 0.7.
- The actuator should not be remodeled to change the operating position.

## Connectors

To satisfy IP67, apply sealing tape to the connector conduit.

Appropriate external diameter of cables is 5.5 to 14 dia.

Use OMRON's SC-□M Series.

Tighten the Connectors to a torque of 1.8 to 2.2 N-m.

## Maintenance and Repair

The user must not maintain or repair equipment incorporating any D4A-N model. Contact the manufacturer of the equipment for any maintenance or repairs required.

## Appropriate Tightening Torque

A loose screw may cause malfunctions. Be sure to tighten each screw to the proper tightening torque as shown in the table.



| No. | Type  | Appropriate tightening torque |
|-----|---|-------------------------------|
| 1   | Terminal screws (M3.5 screws) (including grounding terminals) | 0.78 to 0.88 N-m              |
| 2   | Head mounting screws  | 1.18 to 1.37 N-m              |
| 3   | Switch box mounting screws                                    | 2.35 to 2.75 N-m              |
| 4*  | Body mounting screws  | 4.90 to 5.88 N-m              |
| 5   | Connectors  | 1.77 to 2.16 N-m              |
| 6   | Actuator mounting screws                                      | 2.45 to 2.65 N-m              |

\* When using M5 Allen-head bolts, particularly when the head direction has been changed, check the torque of each screw and make sure that the screws are free of foreign substances, and that each screw is tightened to the proper torque.

## How to Order

The D4A-□N is compatible with the D4A-□ when the following accessories are attached to the D4A-□N.



\* The D4A-□N without the above accessories is not compatible with the D4A-□.



# Precautions for All Limit Switches

(Not including Safety Switches)

**Note:** Refer to the *Precautions* section for each Switch for specific precautions applicable to each Switch.

## Precautions for Safe Use

- If the Switch is to be used as a switch in an emergency stop circuit or in a safety circuit for preventing accidents resulting in injuries or deaths, use a Switch with a direct opening mechanism, use the NC contacts with a forced release mechanism, and set the Switch so that it will operate in direct opening mode.  
For safety, install the Switch using one-way rotational screws or other similar means to prevent it from easily being removed. Protect the Switch with an appropriate cover and post a warning sign near the Switch in order to ensure the safety.
- Do not supply electric power when wiring. Otherwise electric shock may result.
- Keep the electrical load below the rated value.
- Be sure to evaluate the Switch under actual working conditions after installation.
- Do not touch the charged switch terminals while the Switch has carry current, otherwise electric shock may result.
- If the Switch has a ground terminal, be sure to connect the ground terminal to a ground wire.
- Do not disassemble the Switch while electric power is being supply. Otherwise electric shock may result.
- The durability of the Switch greatly varies with switching conditions. Before using the Switch, be sure to test the Switch under actual conditions. Make sure that the number of switching operations is within the permissible range.  
If a deteriorated Switch is used continuously, insulation failures, contact weld, contact failures, switch damage, or switch burnout may result.
- Maintain an appropriate insulation distance between wires connected to the Switch.
- Some types of load have a great difference between normal current and inrush current. Make sure that the inrush current is within the permissible value. The greater the inrush current in the closed circuit is, the greater the contact abrasion or shift will be. Consequently, contact weld, contact separation failures, or insulation failures may result. Furthermore, the Switch may become broken or damaged.

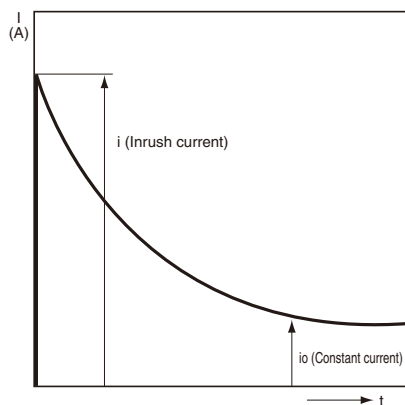

## Wiring

Pay the utmost attention so that each terminal is wired correctly. If the terminal is wired incorrectly, the Switch will not function. Furthermore, not only will the Switch have a bad influence on the external circuit, the Switch itself may become damaged or burnt.

## Mounting

- Do not modify the actuator, otherwise the operating characteristics and performance of the actuator will change.
- Do not enlarge the mounting holes of the Switch or modify the Switch. Doing so may result in insulation failures, housing damage, or physical injuries.
- Be sure to evaluate the Switch under actual working conditions after installation.
- Do not apply oil, grease, or other lubricants to the moving parts of the actuator, otherwise the actuator may not operate correctly. Furthermore, intrusion of oil, grease, or other lubricants inside the Switch may reduce sliding characteristic or cause failures in the Switch.
- Mount the Switch and secure it with the specified screws tightened to the specified torque along with flat washers and springs. The actuator of a Pushbutton Limit Switch mounted to a panel with excessive tightening torque may not operate correctly.
- Be sure to wire the Switch so that the conduit opening is free of metal powder or any other impurities.
- If glue or bonding agent is applied, make sure that it does not adhere to the movable parts or intrude inside the Switch, otherwise the Switch may not work correctly or cause contact failure. Some types of glue or bonding agent may generate a gas that may have a bad influence on the Switch. Pay the utmost attention when selecting the glue or locking agent.
- Do not drop or disassemble the Switch, otherwise the Switch will not be capable of full performance. Furthermore, the Switch may become broken or burnt.
- Some models allow changes in head directions. When changing the head of such a model, make sure that the head is free of any foreign substance. Tighten each screw of the head to the rated torque.
- Be sure to take measures so that no foreign material, oil, or water will penetrate into the Switch through the conduit opening. Be sure to attach a connector suited to the cable thickness and tighten the connector securely to the rated torque.
- Do not impose shock or vibration on the actuator while it is fully pressed. Otherwise, the actuator will partially abrade and an actuation failure may result.

## Wiring

- If the wiring method is incorrect, the wires may get caught on objects or the lead wires may be pulled excessively. Make sure that the lead wires are sufficiently long and secure them along the wiring path.

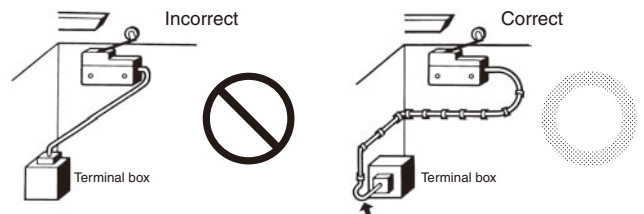

- Pay the utmost attention so that each terminal is wired correctly. If a terminal is wired incorrectly, the Limit Switch will not function properly. Furthermore, not only will the Limit Switch have an adverse influence on external circuits, the Limit Switch itself may become damaged or burnt.

## Precautions for Correct Use

For details, refer to *Precautions for Correct Use* in the *Technical Guide for Limit Switches*.



## Precautions for Correct Use

### Switch Operation

- The Switch in actual operation may cause accidents that cannot be foreseen from the design stage. Therefore, the Switch must be practically tested before actual use.
- When testing the Switch, be sure to apply the actual load condition together with the actual operating environment.
- All the performance ratings in this catalog are provided under the following conditions unless otherwise specified.

#### Inductive load:

A minimum power factor of 0.4 (AC) or a maximum time constant of 7 ms (DC)

#### Lamp load:

An inrush current 10 times higher than the normal current

#### Motor load:

An inrush current 6 times higher than the normal current

(1) Ambient temperature: +5°C to +35°C

(2) Ambient humidity: 40% to 70%RH

Note: An inductive load causes a problem especially in DC circuitry. Therefore, it is essential to know the time constants (L/R) of the load.



### Mechanical Characteristics

#### Operating Force, Stroke, and Contact Characteristics

- The following graph indicates the relationship between operating force and stroke or stroke and contact force. In order to operate the Limit Switch with high reliability, it is necessary to use the Limit Switch within an appropriate contact force range. If the Limit Switch is used in a normally closed condition, the dog must be installed so that the actuator will return to the FP when the actuator is actuated by the dog. If the Limit Switch is used in a normally open condition, the actuator must be pressed to 70% to 100% of the OT (i.e., 60% to 80% of the TT) and any slight fluctuation must be absorbed by the actuator.
- If the full stroke is set close to the OP or RP, contact instability may result. If the full stroke is set to the TTP, the actuator or switch may become damaged due to the inertia of the dog. In that case, adjust the stroke with the mounting panel or the dog. Refer to page 11, Dog Design, page 12, Stroke Settings vs. Dog Movement Distance, and page 12, Dog Surface for details.

- The following graph shows an example of changes in contact force according to the stroke. The contact force near the OP or RP is unstable, and the Limit Switch cannot maintain high reliability. Furthermore, the Limit Switch cannot withstand strong vibration or shock.



- If the Limit Switch is used so that the actuator is constantly pressed, it will fail quickly and reset faults may occur. Inspect the Limit Switch periodically and replace it as required.

#### Mechanical Conditions for Switch Selection

- The actuator must be selected according to the operating method. (Refer to page 9.)
- Check the operating speed and switching frequency.
  1. If the operating speed is extremely low, the switching of the movable contact will become unstable, thus resulting in incorrect contact or contact weld.
  2. If the operating speed is extremely high, the Switch may break due to shock. If the switching frequency is high, the switching of the contacts cannot catch up with the switching frequency. Make sure that the switching frequency is within the rated switching frequency.
- Do not impose excessive force on the actuator, otherwise the actuator may become damaged or not operate correctly.
- Make sure that the stroke is set within the suitable range specified for the model, or otherwise the Switch may break.

#### Electrical Characteristics

##### Electrical Characteristics for Switch Selection

- The switching load capacity of the Switch greatly varies between AC and DC. Always be sure to apply the rated load. The control capacity will drastically drop if it is a DC load. This is because a DC load has no current zero-cross point, unlike an AC load. Therefore, if an arc is generated, it may continue comparatively for a long time. Furthermore, the current direction is always the same, which results in a contact relocation phenomena whereby the contacts easily stick to each other and do not separate when the surfaces of the contacts are uneven.
- If the load is inductive, counter-electromotive voltage will be generated. The higher the voltage is, the higher the generated energy will be, which will increase the abrasion of the contacts and contact relocation phenomena. Be sure to use the Switch within the rated conditions.
- If the load is a minute voltage or current load, use a dedicated Switch for minute loads. The reliability of silver-plated contacts, which are used by standard Switches, will be insufficient if the load is a minute voltage or current load.

## Contact Protective Circuit

Apply a contact protective circuit to increase the contact durability, prevent noise, and suppress the generation of carbide or nitric acid. Be sure to apply the contact protective circuit correctly, otherwise an adverse effect may occur.

The following provides typical examples of contact protective circuits. If the Switch is used in an excessively humid location for switching a load that easily generates arcs, such as an inductive load, the arcs

may generate NO<sub>x</sub>, which will change into HNO<sub>3</sub> if it reacts with moisture.

Consequently, the internal metal parts may corrode and the Switch may fail. Be sure to select the ideal contact preventive circuit from the following.

Also, load operating times may be delayed somewhat if a contact protective circuit (a surge killer) is used.

## Typical Examples of Contact Protective Circuits

| Circuit example              | Applicable current |               | Feature and details | Element selection   |   |
|------------------------------|--------------------|---------------|---------------------|---|---|
|                              | AC                 | DC            |                     |   |   |
| CR circuit                   |                    | Conditional * | ○                   | * When AC is switched, the load impedance must be lower than the CR impedance.  | <p>C: 1 to 0.5 μF × switching current (A)<br/>R: 0.5 to 1 Ω × switching voltage (V)</p> <p>The values may change according to the characteristics of the load.</p> <p>The capacitor suppresses the spark discharge of current when the contacts are open. The resistor limits the inrush current when the contacts are closed again. Consider the roles of the capacitor and resistor and determine ideal capacitance and resistance values through testing.</p> <p>Generally, use a capacitor that has a dielectric strength of between 200 and 300 V. Use an AC capacitor for an AC circuit, i.e., a capacitor that has no polarity.</p> <p>If, however, the arc shutoff capacity between the contacts is a problem at high DC voltages, it may be more effective to connect a capacitor and resistor across the contacts rather than the load. Performing testing to determine the most suitable method.</p> |
|                              |                    | ○             | ○                   | The operating time will be greater if the load is a relay or solenoid. Connecting the CR circuit in parallel to the load is effective when the power supply voltage is 24 or 48 V and in parallel to the contacts when the power supply voltage is 100 to 200 V.  |   |
| Diode method                 |                    | ×             | ○                   | Energy stored in the coil is changed into current by the diode connected in parallel to the load. Then the current flowing to the coil is consumed and Joule heat is generated by the resistance of the inductive load. The reset time delay with this method is longer than that in the CR method.   | The diode must withstand a peak inverse voltage 10 times higher than the circuit voltage and a forward current as high or higher than the load current.   |
| Diode and Zener diode method |                    | ×             | ○                   | This method will be effective if the reset time delay caused by the diode method is too long.   | If a suitable Zener voltage is not used, the load may fail to operate depending on the environment. Use a Zener diode with a Zener voltage that is about 1.2 times the power supply voltage.  |
| Varistor method              |                    | ○             | ○                   | This method makes use of constant-voltage characteristic of the varistor so that no high voltage is imposed on the contacts. This method causes a reset time delay. Connecting a varistor in parallel to the load is effective when the supply voltage is 24 to 48 V and in parallel to the contacts when the supply voltage is 100 to 200 V. | Select a varistor with a cut voltage V <sub>c</sub> that satisfies the following formula. For AC, the voltage must be multiplied by the square root of 2.<br>V <sub>c</sub> > Power supply voltage × 1.5<br>If V <sub>c</sub> is set too high, effectiveness will be reduced because high voltages will not be cut.   |

Do not apply contact protective circuits (surge killers) as shown below.

|  |  |  |
|--|--|--|
|  |  | This circuit effectively suppresses arcs when the contacts are OFF. When the contacts are open, capacity is stored in the capacitor, and short-circuit current of the capacitor will flow when the contacts are turned ON, which may cause contacts to weld. |
|  |  | This circuit effectively suppresses arcs when the contacts are OFF. When the contacts are ON again, however, charge current will flow to the capacitor, which may result in contact weld.  |

## Using Switches for Micro Loads

Contact faults may occur if a Switch for a general-load is used to switch a micro load circuit. Use switches in the ranges shown in the diagram on the right. However, even when using micro load models within the operating range shown here, if inrush current occurs when the contact is opened or closed, it may increase contact wear and so decrease durability. Therefore, insert a contact protection circuit where necessary. The minimum applicable load is the N-level reference value. This value indicates the malfunction reference level for the reliability level of 60% ( $\lambda_{60}$ ).

The equation,  $\lambda_{60} = 0.5 \times 10^{-6}/\text{operations}$  indicates that the estimated malfunction rate is less than 1/2,000,000 operations with a reliability level of 60%.



# Technical Guide for Limit Switches

## Connections

- Do not connect a Single Limit Switch to two power supplies that are different in polarity or type.

Power Connection Examples  
(Connection of Different Polarities)



Incorrect Power Connection Example  
(Connection of Different Power Supplies)  
There is a risk of AC and DC mixing.



Connect the load to the same polarities.

- Do not design a circuit where voltage is imposed between contacts, otherwise contact welding may result.



- Do not use a circuit that will short-circuit if an error occurs, otherwise the charged part may melt and break off.



- Application of Switch to a Low-voltage, Low-current Electronic Circuit.

- If bouncing or chattering of the contacts results and causes problems, take the following countermeasures.
    - Insert an integral circuit.
    - Suppress the generation of pulse from the contact bouncing or chattering of the contacts so that it is less than the noise margin of the load.
  - Conventional silver-plated contacts are not suited to this application. Use gold-plated contacts, which are ideal for handling minute voltage or current loads.
  - The contacts of the Switch used for an emergency stop must be normally closed with a positive opening mechanism.
- In order to protect the Switch from damage due to short-circuits, be sure to connect a quick-response fuse with a breaking current 1.5 to 2 times larger than the rated current to the Switch in series. When complying with EN approved ratings, use a 10-A IEC 60269-compliant gI or gG fuse.

## Operating Environment

- Do not use the Switch by itself in atmospheres containing flammable or explosive gases. Arcs and heating resulting from switching may cause fire or explosion.
- Use protective covers to protect Switches that are not specified as waterproof or airtight whenever they are used in locations subject to splattering or spraying oil or water, or to accumulation of dust or dirt.



- The materials of Limit Switch may change in quality or deteriorate if the Limit Switch is used outdoors or any other location where the Limit Switch is exposed to special machining oil. Consult your OMRON representative before selecting the model.
- Be sure to install the Switch so that the Switch is free from dust or metal powder. The actuator and the switch casing must be protected from the accumulation of dust or metal powder.



- Do not use the Switch in locations where the Switch is exposed to hot water at a temperature greater than 60°C or steam.
- Do not use the Switch under temperatures or other environmental conditions not within the specified ranges. The rated permissible ambient temperature range varies with the model. Refer to the specifications in this catalog. If the Switch is exposed to radical temperature changes, the thermal shock may deform the Switch and the Switch may malfunction.



- Be sure to protect the Switch with a cover if the Switch is in a location where the Switch may be actuated by mistake or where the Switch is likely cause an accident.



- If vibration or shock is continuously imposed on the Switch, contact failure, malfunction, or decrease in service life may be caused by abrasive powder generated from the internal parts. If excessive vibration or shock is imposed on the Switch, the contacts may malfunction or become damaged. Make sure to install the Switch in locations free of constant vibration or shock.
- Do not use the Switch with silver-plated contacts for long periods if the switching frequency of the Switch is comparatively low or the load is minute. Otherwise, sulfuric film will be generated on the contacts and contact failures may result. Use the Switch with gold-plated contacts or use a dedicated Switch for minute loads instead.

- Do not use the Switch in locations with corrosive gas, such as sulfuric gas ( $H_2S$  or  $SO_2$ ), ammonium gas ( $NH_3$ ), nitric gas ( $HNO_3$ ), or chlorine gas ( $Cl_2$ ), or high temperature and humidity. Otherwise, contact failure or corrosion damage may result.
- If the Switch is used in locations with silicone gas, arc energy may create silicon dioxide ( $SiO_2$ ) on the contacts and a contact failure may result. If there is silicone oil, silicone sealant, or wire covered with silicone close to the Switch, attach a contact protective circuit to suppress the arcing of the Switch or eliminate the source of silicone gas generation.

## Regular Inspection and Replacement

- If the Switch is normally closed with low switching frequency (e.g., once or less than once a day), a reset failure may result due to the deterioration of the parts of the Switch. Regularly inspect the Switch and make sure that the Switch is in good working order.
- In addition to the mechanical durability or electrical durability of the Switch described previously, the durability of the Switch may decrease due to the deterioration of each part, especially rubber, resin, and metal. Regularly inspect the Switch and replace any part that has deteriorated in order to prevent accidents from occurring.
- If the Switch is not turned On or OFF for a long time, oxidation of the contacts may decrease contact reliability. Faulty continuity may result in accidents.
- Be sure to mount the Switch securely in a clean location to ensure ease of inspection and replacement. The Switch with operation indicator is available, which is ideal if the location is dark or does not allow easy inspection or replacement.



## Storage of Switch

- When storing the Switch, make sure that the location is free of corrosive gas, such as  $H_2S$ ,  $SO_2$ ,  $NH_3$ ,  $HNO_3$ , or  $Cl_2$ , or dust and does not have a high temperature or humidity.
- Be sure to inspect the Switch before use if it has been stored for three months or more.

## Weather Resistance, Cold Resistance, and Heat Resistance

Silicon rubber is used to increase resistance to weather, cold, and heat. Silicon rubber, however, can generate silicon gas. (This can occur at room temperature, but the amount of silicon gas generated increases at higher temperatures.) Silicon gas will react as a result of arc energy and form silicon oxide ( $SiO_2$ ). If silicon oxide accumulates on the contacts, contact interference can occur and can interfere with the device. Before using a Switch, test it under actual application conditions (including the environment and operating frequency) to confirm that no problems will occur in actual.

## Outdoor Use

- If the Limit Switch is used in places with sludge or dust powder spray, make sure that the mechanical parts are sealed with a rubber cap.
- The rubber materials exposed to ozone may deteriorate. Check that the rubber parts are made of environment-resistive materials, such as chloroprene, silicone, or fluorine rubber.
- Due to capillary attraction, rainwater may enter the Limit Switch through the lead wires or sheath. Be sure to cover the wire connections in a terminal box so that they are not directly exposed to rainwater.
- If the Limit Switch is used outdoors, the steel parts of the Limit Switch (such as the screws and plunger parts) may corrode. Models with resistance against climatic conditions have been added to the series. Consider using outdoor models, such as the WL-□P1 or D4C-□P.
- "Limit Switch is used outdoors" refers to an environment where the Limit Switch is exposed directly to rainwater or sunlight (e.g., multistory parking facilities) excluding locations with corrosive gas or salty breezes. A Limit Switch used outdoors may not release due to icing and may not satisfy specified standards.

## Operation

- Carefully determine the position and shape of the dog or cam so that the actuator will not abruptly snap back, thus causing shock. In order to operate the Limit Switch at a comparatively high speed, use a dog or cam that keeps the Limit Switch turned ON for a sufficient time so that the relay or valve will be sufficiently energized.
- The method of operation, the shape of the cam or dog, the operating frequency, and the travel after operation have a large influence on the durability and operating accuracy of the Limit Switch. The cam or dog must be smooth in shape.



- Appropriate force must be imposed on the actuator by the cam or dog in both rotary operation and linear operation. If the dog touches the lever as shown below, the operating position will not be stable.



# Technical Guide for Limit Switches

- Unbalanced force must not be imposed on the actuator. Otherwise, wear and tear on the actuator may result.



- With a roller actuator, the dog must touch the actuator at a right angle. The actuator or shaft may deform or break if the dog touches the actuator (roller) at an oblique angle.



- Make sure that the actuator does not exceed the OT (overtravel) range, otherwise the Limit Switch may malfunction. When mounting the Limit Switch, be sure to adjust the Limit Switch carefully while considering the whole movement of the actuator.



- The Limit Switch may soon malfunction if the OT is excessive. Therefore, adjustments and careful consideration of the position of the Limit Switch and the expected OT of the operating body are necessary when mounting the Limit Switch.



- When using a pin-plunger actuator, make sure that the stroke of the actuator and the movement of the dog are located along a single straight line.



- Be sure to use the Limit Switch according to the characteristics of the actuator. If a roller arm lever actuator is used, do not attempt to actuate the Limit Switch in the direction shown below.

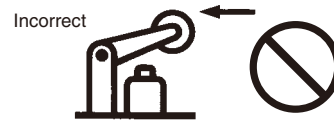

- Do not modify the actuator to change the OP.
- With the long actuator of an Adjustable Roller Lever Switch, the following countermeasures against lever shaking are recommended.
  1. Make the rear edge of the dog smooth with an angle of 15° to 30° or make it in the shape of a quadratic curve.
  2. Design the circuit so that no error signal will be generated.
  3. Use a switch that is actuated in one direction only. (Alternatively, set the Switch so that it is operated only in one direction.)
- With a bevel plunger actuator, make sure that the width of the dog is wider than that of the plunger.



## Dog Design

### Speed and Angle of Dog and Relationship with Actuator

Before designing a dog, carefully consider the operating speed and angle of the dog ( $\phi$ ) and their relationship with the shape of the actuator. The optimum operating speed ( $V$ ) of a standard dog at an angle of  $30^\circ$  to  $45^\circ$  is 0.5 m/s maximum.

### Roller Lever Switches

#### (1) Non-overtravel Dog

**Dog speed: 0.5 m/s max. (standard speed)**



| $\phi$                   | V max. (m/s)     | y                   |
|--------------------------|------------------|---------------------|
| $30^\circ$               | 0.4              | 0.8 (TT)            |
| $45^\circ$               | 0.25             | 80% of total travel |
| $60^\circ$               | 0.1              |                     |
| $60^\circ$ to $90^\circ$ | 0.05 (low speed) |                     |

**Dog speed:  $0.5 \text{ m/s} \leq V \leq 2 \text{ m/s}$  (high speed)**



| $\theta$                 | $\phi$                   | V max. (m/s) | y               |
|--------------------------|--------------------------|--------------|-----------------|
| $45^\circ$               | $45^\circ$               | 0.5          | 0.5 to 0.8 (TT) |
| $50^\circ$               | $40^\circ$               | 0.6          | 0.5 to 0.8 (TT) |
| $60^\circ$ to $55^\circ$ | $30^\circ$ to $35^\circ$ | 1.3          | 0.5 to 0.7 (TT) |
| $75^\circ$ to $65^\circ$ | $15^\circ$ to $25^\circ$ | 2            | 0.5 to 0.7 (TT) |

Note: The above y values indicate the ratio ranges based on TT (total travel). Therefore, the optimum pressing distance of the dog is between 50% and 80% (or 50% and 70%).

#### (2) Overtravel Dog

**Dog speed: 0.5 m/s max.**

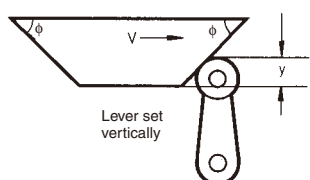

| $\phi$                   | V max. (m/s)     | y                   |
|--------------------------|------------------|---------------------|
| $30^\circ$               | 0.4              | 0.8 (TT)            |
| $45^\circ$               | 0.25             | 80% of total travel |
| $60^\circ$               | 0.1              |                     |
| $60^\circ$ to $90^\circ$ | 0.05 (low speed) |                     |

**Dog speed: 0.5 m/s min.**

If the speed of the overtravel dog is comparatively high, make the rear edge of the dog smooth at an angle of  $15^\circ$  to  $30^\circ$  or make it in the shape of a quadratic curve. Then lever shaking will be reduced.



| $\theta$                 | $\phi$                   | V max. (m/s) | y               |
|--------------------------|--------------------------|--------------|-----------------|
| $45^\circ$               | $45^\circ$               | 0.5          | 0.5 to 0.8 (TT) |
| $50^\circ$               | $40^\circ$               | 0.6          | 0.5 to 0.8 (TT) |
| $60^\circ$ to $55^\circ$ | $30^\circ$ to $35^\circ$ | 1.3          | 0.5 to 0.7 (TT) |
| $75^\circ$ to $65^\circ$ | $15^\circ$ to $25^\circ$ | 2            | 0.5 to 0.7 (TT) |

Note: The above y values indicate the ratio ranges based on TT (total travel). Therefore, the optimum pressing distance of the dog is between 50% and 80% (or 50% and 70%).

### Plunger Switches

If the dog overrides the actuator, the front and rear of the dog may be the same in shape, provided that the dog is not designed to be separated from the actuator abruptly.

**Roller Plunger**



| $\phi$     | V max. (m/s) | y               |
|------------|--------------|-----------------|
| $30^\circ$ | 0.25         | 0.6 to 0.8 (TT) |
| $20^\circ$ | 0.5          | 0.5 to 0.7 (TT) |

**Ball Plunger**



| $\phi$     | V max. (m/s) | y               |
|------------|--------------|-----------------|
| $30^\circ$ | 0.25         | 0.6 to 0.8 (TT) |
| $20^\circ$ | 0.5          | 0.5 to 0.7 (TT) |

**Bevel Plunger**



| $\phi$     | V max. (m/s) | y               |
|------------|--------------|-----------------|
| $30^\circ$ | 0.25         | 0.6 to 0.8 (TT) |
| $20^\circ$ | 0.5          | 0.5 to 0.7 (TT) |

Note: The above y values indicate the ratio ranges based on TT (total travel). Therefore, the optimum pressing distance of the dog is between 60% and 80% (or 50% and 70%).

### Fork Lever Lock Models



Note: Design the shape of the dog so that it does not come in contact with the other roller lever when the actuator is inverted.

## Stroke Settings vs. Dog Movement Distance

- The following information on stroke settings is based on the movement distance of the dog instead of the actuator angle. The following is the optimum stroke of the Limit Switch.  
Optimum stroke:  $PT + \{\text{Rated OT} \times (0.7 \text{ to } 1.0)\}$   
In terms of angles, the optimum stroke is expressed as  $\theta_1 + \theta_2$ .

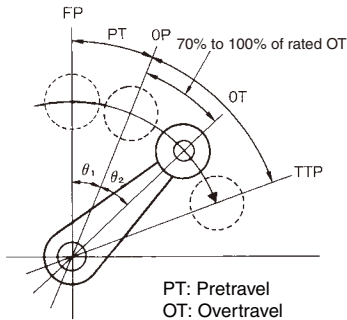

- The movement distance of the dog based on the optimum stroke is expressed by the following formula.  
Movement distance of dog

$$X = R \sin \theta + \frac{R (1 - \cos \theta)}{\tan \phi} \text{ (mm)}$$

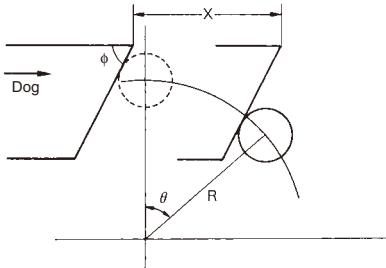

- $\phi$ : Dog angle
- $\theta$ : Optimum stroke angle
- R: Actuator length
- X: Dog movement distance

- The distance between the reference line and the bottom of the dog based on the optimum stroke is expressed by the following formula.  
 $Y = a + b + r$  (mm)

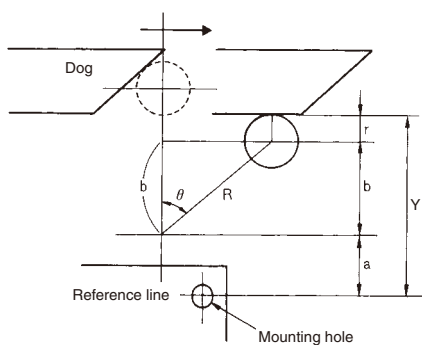

- a: Distance between reference line and actuator fulcrum
- b:  $R \cos \theta$
- r: Roller radius
- Y: Distance between reference line and bottom of dog

## Dog Surface

The surface of dog touching the actuator should be 6.3 S in quality and a hardness of approximately HV450. For smooth operation of the actuator, apply molybdenum disulfide grease to the actuator and the dog touching the actuator. This is ideal for Limit Switches of drip-proof construction and Multiple Limit Switches.

## Maintenance and Repairs

The user of the system must not attempt to perform maintenance and repairs. Contact the manufacturer of the system concerning maintenance and repairs.

## Other

- The standard material for the switch seal is nitrile rubber (NBR), which has superior resistance to oil. Depending on the type of oil or chemicals in the application environment, however, NBR may deteriorate, e.g., swell or shrink. Confirm performance in advance.
- The correct Switch must be selected for the load to ensure contact reliability. Refer to precautions for micro loads in individual product information for details.
- When using a Limit Switch with a long lever or long rod lever, make sure that the lever is in the downward direction.
- Wire the leads as shown in the following diagram.

### Correct Wiring



### Incorrect Wiring



- Reduced ambient temperature tends to result in hardening of the actuator's rubber seal. Therefore, reset may be delayed or reset may fail if the Switch is used with the actuator continually pressed in. Contact your OMRON representative if the Switch is to be used for this type of environment or application.

## Read and Understand This Catalog

Please read and understand this catalog before purchasing the products. Please consult your OMRON representative if you have any questions or comments.

## Warranty and Limitations of Liability

### WARRANTY

OMRON's exclusive warranty is that the products are free from defects in materials and workmanship for a period of one year (or other period if specified) from date of sale by OMRON.

OMRON MAKES NO WARRANTY OR REPRESENTATION, EXPRESS OR IMPLIED, REGARDING NON-INFRINGEMENT, MERCHANTABILITY, OR FITNESS FOR PARTICULAR PURPOSE OF THE PRODUCTS. ANY BUYER OR USER ACKNOWLEDGES THAT THE BUYER OR USER ALONE HAS DETERMINED THAT THE PRODUCTS WILL SUITABLY MEET THE REQUIREMENTS OF THEIR INTENDED USE. OMRON DISCLAIMS ALL OTHER WARRANTIES, EXPRESS OR IMPLIED.

### LIMITATIONS OF LIABILITY

OMRON SHALL NOT BE RESPONSIBLE FOR SPECIAL, INDIRECT, OR CONSEQUENTIAL DAMAGES, LOSS OF PROFITS, OR COMMERCIAL LOSS IN ANY WAY CONNECTED WITH THE PRODUCTS, WHETHER SUCH CLAIM IS BASED ON CONTRACT, WARRANTY, NEGLIGENCE, OR STRICT LIABILITY.

In no event shall responsibility of OMRON for any act exceed the individual price of the product on which liability is asserted.

IN NO EVENT SHALL OMRON BE RESPONSIBLE FOR WARRANTY, REPAIR, OR OTHER CLAIMS REGARDING THE PRODUCTS UNLESS OMRON'S ANALYSIS CONFIRMS THAT THE PRODUCTS WERE PROPERLY HANDLED, STORED, INSTALLED, AND MAINTAINED AND NOT SUBJECT TO CONTAMINATION, ABUSE, MISUSE, OR INAPPROPRIATE MODIFICATION OR REPAIR.

## Application Considerations

### SUITABILITY FOR USE

OMRON shall not be responsible for conformity with any standards, codes, or regulations that apply to the combination of products in the customer's application or use of the product.

At the customer's request, OMRON will provide applicable third party certification documents identifying ratings and limitations of use that apply to the products. This information by itself is not sufficient for a complete determination of the suitability of the products in combination with the end product, machine, system, or other application or use.

The following are some examples of applications for which particular attention must be given. This is not intended to be an exhaustive list of all possible uses of the products, nor is it intended to imply that the uses listed may be suitable for the products:

- Outdoor use, uses involving potential chemical contamination or electrical interference, or conditions or uses not described in this catalog.
- Nuclear energy control systems, combustion systems, railroad systems, aviation systems, medical equipment, amusement machines, vehicles, safety equipment, and installations subject to separate industry or government regulations.
- Systems, machines, and equipment that could present a risk to life or property.

Please know and observe all prohibitions of use applicable to the products.

NEVER USE THE PRODUCTS FOR AN APPLICATION INVOLVING SERIOUS RISK TO LIFE OR PROPERTY WITHOUT ENSURING THAT THE SYSTEM AS A WHOLE HAS BEEN DESIGNED TO ADDRESS THE RISKS, AND THAT THE OMRON PRODUCT IS PROPERLY RATED AND INSTALLED FOR THE INTENDED USE WITHIN THE OVERALL EQUIPMENT OR SYSTEM.

## Disclaimers

### CHANGE IN SPECIFICATIONS

Product specifications and accessories may be changed at any time based on improvements and other reasons.

It is our practice to change model numbers when published ratings or features are changed, or when significant construction changes are made. However, some specifications of the product may be changed without any notice. When in doubt, special model numbers may be assigned to fix or establish key specifications for your application on your request. Please consult with your OMRON representative at any time to confirm actual specifications of purchased product.

### DIMENSIONS AND WEIGHTS

Dimensions and weights are nominal and are not to be used for manufacturing purposes, even when tolerances are shown.

### ERRORS AND OMISSIONS

The information in this catalog has been carefully checked and is believed to be accurate; however, no responsibility is assumed for clerical, typographical, or proofreading errors, or omissions.

### PERFORMANCE DATA

Performance data given in this catalog is provided as a guide for the user in determining suitability and does not constitute a warranty. It may represent the result of OMRON's test conditions, and the users must correlate it to actual application requirements. Actual performance is subject to the OMRON Warranty and Limitations of Liability.

### PROGRAMMABLE PRODUCTS

OMRON shall not be responsible for the user's programming of a programmable product, or any consequence thereof.

### COPYRIGHT AND COPY PERMISSION

This catalog shall not be copied for sales or promotions without permission.

This catalog is protected by copyright and is intended solely for use in conjunction with the product. Please notify us before copying or reproducing this catalog in any manner, for any other purpose. If copying or transmitting this catalog to another, please copy or transmit it in its entirety.





## Стандарт Электрон Связь

Мы молодая и активно развивающаяся компания в области поставок электронных компонентов. Мы поставляем электронные компоненты отечественного и импортного производства напрямую от производителей и с крупнейших складов мира.

Благодаря сотрудничеству с мировыми поставщиками мы осуществляем комплексные и плановые поставки широчайшего спектра электронных компонентов.

Собственная эффективная логистика и склад в обеспечивает надежную поставку продукции в точно указанные сроки по всей России.

Мы осуществляем техническую поддержку нашим клиентам и предпродажную проверку качества продукции. На все поставляемые продукты мы предоставляем гарантию .

Осуществляем поставки продукции под контролем ВП МО РФ на предприятия военно-промышленного комплекса России , а также работаем в рамках 275 ФЗ с открытием отдельных счетов в уполномоченном банке. Система менеджмента качества компании соответствует требованиям ГОСТ ISO 9001.

Минимальные сроки поставки, гибкие цены, неограниченный ассортимент и индивидуальный подход к клиентам являются основой для выстраивания долгосрочного и эффективного сотрудничества с предприятиями радиоэлектронной промышленности, предприятиями ВПК и научно-исследовательскими институтами России.

С нами вы становитесь еще успешнее!

### Наши контакты:

**Телефон:** +7 812 627 14 35

**Электронная почта:** [sales@st-electron.ru](mailto:sales@st-electron.ru)

**Адрес:** 198099, Санкт-Петербург,  
Промышленная ул, дом № 19, литера Н,  
помещение 100-Н Офис 331