

CUTE-3-M

~25° medium beam with 1.5 mm high location pins

TECHNICAL SPECIFICATIONS:

Dimensions	Ø 35.0 mm
Height	15 mm
Fastening	glue, pin
ROHS compliant	yes ⓘ

MATERIAL SPECIFICATIONS:

Component	Type	Material	Colour	Finish
CUTE-3-M	Multi-lens	PMMA	clear	



ORDERING INFORMATION:

Component	Qty in box	MOQ	MPQ	Box weight (kg)
C11334_CUTE-3-M » Box size: 480 x 280 x 300 mm	630	90	45	6.8

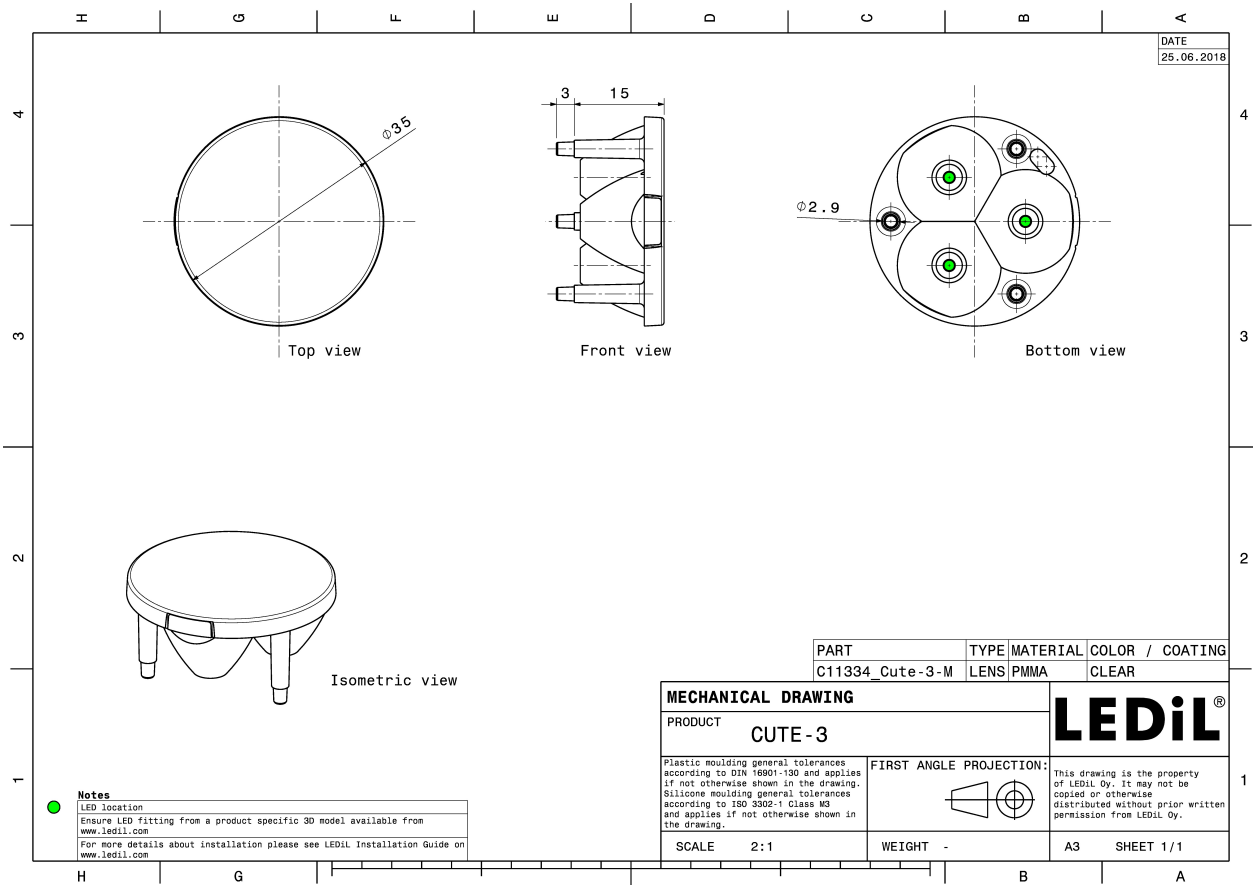

PHOTOMETRIC DATA (MEASURED):

CREE 

LED XM-L
FWHM 25.0°
Efficiency 90 %
Peak intensity cd/lm
LEDs/each optic 1
Light colour White
Required components:

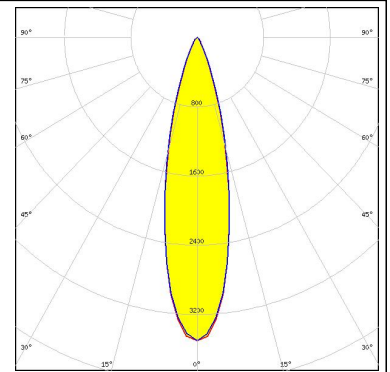
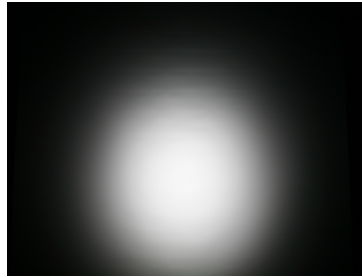

CREE 

LED XM-L2
FWHM 26.0°
Efficiency 89 %
Peak intensity 3.700 cd/lm
LEDs/each optic 1
Light colour White
Required components:

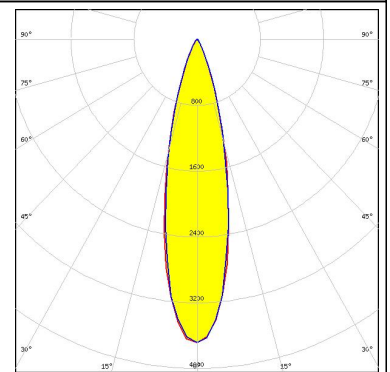
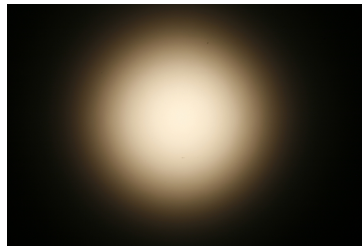

CREE 

LED XP-E
FWHM 22.0°
Efficiency 91 %
Peak intensity cd/lm
LEDs/each optic 1
Light colour White
Required components:

CREE 

LED XP-G
FWHM 24.0°
Efficiency 91 %
Peak intensity cd/lm
LEDs/each optic 1
Light colour White
Required components:

PHOTOMETRIC DATA (MEASURED):

CREE

LED XP-L HD
FWHM 24.0°
Efficiency 88 %
Peak intensity 3.900 cd/lm
LEDs/each optic 1
Light colour White
Required components:



LUMILEDS

LED LUXEON A
FWHM 24.0°
Efficiency %
Peak intensity cd/lm
LEDs/each optic 1
Light colour White
Required components:

LUMILEDS

LED LUXEON Rebel
FWHM 22.0°
Efficiency 91 %
Peak intensity cd/lm
LEDs/each optic 1
Light colour White
Required components:

LUMILEDS

LED LUXEON Rebel ES
FWHM 24.0°
Efficiency 92 %
Peak intensity cd/lm
LEDs/each optic 1
Light colour White
Required components:

PHOTOMETRIC DATA (MEASURED):

LUMILEDS

LED LUXEON T
FWHM 23.0°
Efficiency 89 %
Peak intensity 4.200 cd/lm
LEDs/each optic 1
Light colour White
Required components:

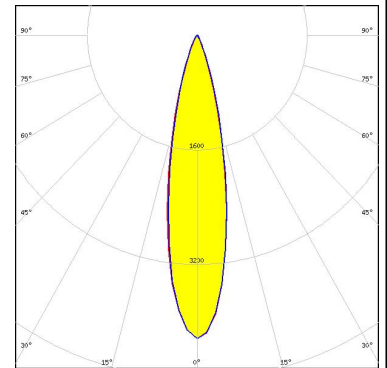

LUMILEDS

LED LUXEON TX
FWHM 25.0°
Efficiency 88 %
Peak intensity 4.300 cd/lm
LEDs/each optic 1
Light colour White
Required components:

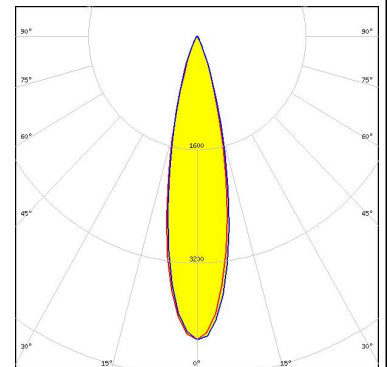
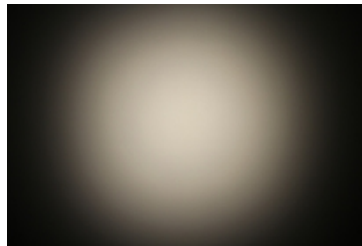

NICHIA

LED NCSxx19A
FWHM 25.0°
Efficiency 88 %
Peak intensity cd/lm
LEDs/each optic 1
Light colour White
Required components:

NICHIA

LED NVSxx19A
FWHM 25.0°
Efficiency 88 %
Peak intensity cd/lm
LEDs/each optic 1
Light colour White
Required components:

PHOTOMETRIC DATA (MEASURED):

OSRAM

Opto Semiconductors

LED OSLON SSL 150
FWHM 24.0°
Efficiency %
Peak intensity cd/lm
LEDs/each optic 1
Light colour White
Required components:

OSRAM

Opto Semiconductors

LED OSLON SSL 80
FWHM 22.0°
Efficiency 89 %
Peak intensity cd/lm
LEDs/each optic 1
Light colour White
Required components:

TOSHIBA

Leading Innovation >>>

LED TL1L3
FWHM 26.0°
Efficiency 86 %
Peak intensity 2.600 cd/lm
LEDs/each optic 1
Light colour White
Required components:

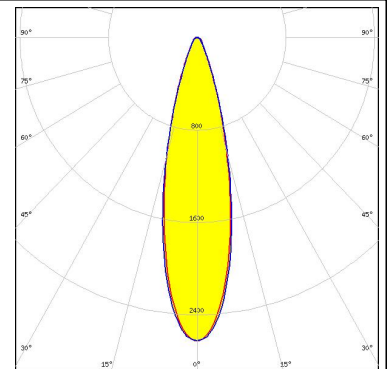
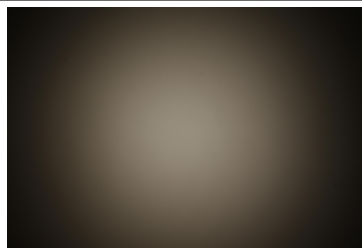

PHOTOMETRIC DATA (SIMULATED):



LED XM-L HVW
FWHM 33.0°
Efficiency %
Peak intensity cd/lm
LEDs/each optic 1
Light colour White
Required components:



LED XT-E HVW
FWHM 30.0°
Efficiency %
Peak intensity cd/lm
LEDs/each optic 1
Light colour White
Required components:



LED LUXEON H50-2
FWHM 30.0°
Efficiency 90 %
Peak intensity 2.700 cd/lm
LEDs/each optic 1
Light colour White
Required components:

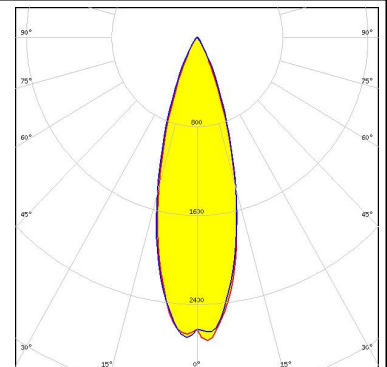

LED NVSxx19B/NVSxx19C
FWHM 30.0°
Efficiency 89 %
Peak intensity 2.530 cd/lm
LEDs/each optic 1
Light colour White
Required components:

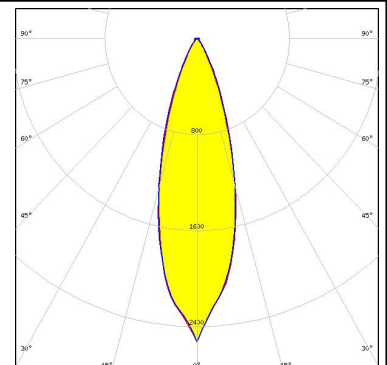

PHOTOMETRIC DATA (SIMULATED):

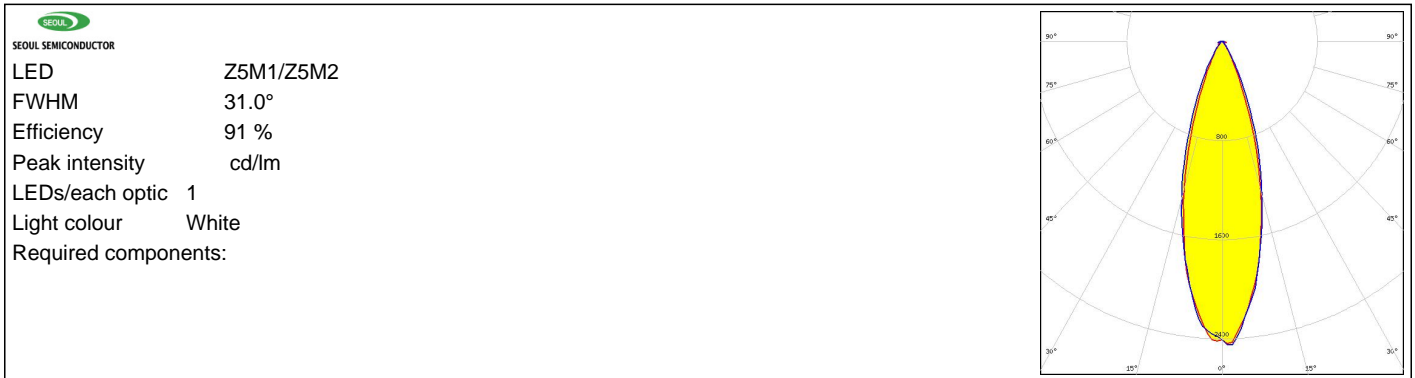

GENERAL INFORMATION:

NOTE: The typical beam angle will be changed by different color, chip size and chip position tolerance. The typical total beam angle is the full angle measured where the luminous intensity is half of the peak value.

MATERIALS:

As part of our continuous research and improvement processes, and to ensure the best possible quality and availability of our products, LEDiL reserves the right to change material grades without notice.

PRODUCT DATA USER AGREEMENT AND DISCLAIMER:

The measured data in the provided downloadable LEDiL Product Datasheets and Mechanical 2D-Drawings is rounded and provided as reference for planning. LEDiL Oy's optical specifications have been verified by conducting performance testing of the products in accordance with the company's quality system. The reported data are averaged results of multiple measurements with typical variation. LEDiL Oy reserves the right to without prior notification make changes and improvements to its products.

LEDiL Oy assumes neither warranty, nor guarantee nor any other liability of any kind for the contents and correctness of the provided data. The provided data has been generated with highest diligence but the provided data may in reality not represent the complete possible variation range of all intrinsic parameters. Therefore, in certain cases a deviation from the provided data could occur.

LEDiL Oy reserves the right to undertake technical changes of its products without further notification which could lead to changes in the provided data. LEDiL Oy assumes no liability of any kind for the possible deviation from any provided data or any other damage resulting from the usage of the provided data.

The user agrees to this disclaimer and user agreement with the download or usage of the provided files.

LEDiL Oy

Joensuunkatu 13
FI-24240 SALO
Finland

LEDiL Inc.

228 West Page Street
Suite D
Sycamore IL 60178
USA

Local sales and technical support

[www.ledil.com/
where_to_buy](http://www.ledil.com/where_to_buy)

Shipping locations

Salo, Finland
Hong Kong, China

Distribution Partners

[www.ledil.com/
where_to_buy](http://www.ledil.com/where_to_buy)



**Стандарт
Электрон
Связь**

Мы молодая и активно развивающаяся компания в области поставок электронных компонентов. Мы поставляем электронные компоненты отечественного и импортного производства напрямую от производителей и с крупнейших складов мира.

Благодаря сотрудничеству с мировыми поставщиками мы осуществляем комплексные и плановые поставки широчайшего спектра электронных компонентов.

Собственная эффективная логистика и склад в обеспечивает надежную поставку продукции в точно указанные сроки по всей России.

Мы осуществляем техническую поддержку нашим клиентам и предпродажную проверку качества продукции. На все поставляемые продукты мы предоставляем гарантию .

Осуществляем поставки продукции под контролем ВП МО РФ на предприятия военно-промышленного комплекса России , а также работаем в рамках 275 ФЗ с открытием отдельных счетов в уполномоченном банке. Система менеджмента качества компании соответствует требованиям ГОСТ ISO 9001.

Минимальные сроки поставки, гибкие цены, неограниченный ассортимент и индивидуальный подход к клиентам являются основой для выстраивания долгосрочного и эффективного сотрудничества с предприятиями радиоэлектронной промышленности, предприятиями ВПК и научно-исследовательскими институтами России.

С нами вы становитесь еще успешнее!

Наши контакты:

Телефон: +7 812 627 14 35

Электронная почта: sales@st-electron.ru

Адрес: 198099, Санкт-Петербург,
Промышленная ул, дом № 19, литера Н,
помещение 100-Н Офис 331