



25W Multiple-Stage Output Current LED Power Supply **LCM-25DA** series



■ Features

- Output current level selectable by DIP S.W.
- 180~277VAC input only
- Built-in active PFC function
- Protections: Short circuit / Over temperature
- Cooling by free air convection
- Fully isolated plastic case
- Class II power unit, no FG
- Built-in DALI interface and push dimming function
- IP20 design
- Logarithm or linear dimming curve selectable (Meet IEC62386-207)
- No load power consumption <0.5W(Note.7)
- Power supplies synchronization function up to 10 units
- 3 years warranty

■ Applications

- Indoor LED lighting
- Office LED lighting
- LED decorative lighting

■ Description

LCM-25DA is a 25W LED power supply that one single unit supplies multiple current levels, 350mA/ 500mA/600mA/700mA/900mA/1050mA. The current levels are able to be easily switched by adjusting the built-in DIP switch. LCM-25DA also provides the dimming function that is controlled by push dimming or DALI signal. Moreover, the synchronization design allows the dimming for up to 10 units of LCM-25DA to be controlled simultaneously.

■ Model Encoding

LCM - 25 DA

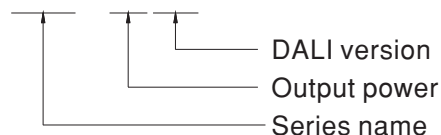

**SPECIFICATION**

MODEL		LCM-25DA					
OUTPUT	SELECTABLE CURRENT <small>Note.3</small>	350mA	500mA	600mA	700mA	900mA	1050mA
	DC VOLTAGE RANGE	6 ~ 54V	6 ~ 50V	6 ~ 42V	6 ~ 36V	6 ~ 28V	6 ~ 24V
	RATED POWER	18.9W	25.2W				
	RIPPLE CURRENT	± 5.0%					
	RIPPLE & NOISE (max.) <small>Note.2</small>	400mVp-p					
	NO LOAD OUTPUT VOLTAGE (max.)	59V			41V		
	CURRENT ACCURACY	± 5.0%					
	SETUP, RISE TIME <small>Note.5</small>	500ms, 50ms / 230VAC at full load					
HOLD UP TIME (Typ.)	30ms / 230VAC at full load						
INPUT	VOLTAGE RANGE <small>Note.4</small>	180 ~ 277VAC	254 ~ 392VDC				
	FREQUENCY RANGE	47 ~ 63Hz					
	POWER FACTOR (Typ.)	PF ≥ 0.94/230VAC, PF ≥ 0.91/277VAC at full load (Please refer to "Power Factor Characteristic" section)					
	TOTAL HARMONIC DISTORTION	THD < 20% when output loading ≥ 50% at 230VAC input and output loading ≥ 75% at 277VAC input					
	EFFICIENCY (Typ.) <small>Note.6</small>	86%					
	AC CURRENT (Typ.)	0.17A/230VAC	0.15A/277VAC				
	INRUSH CURRENT(max.)	COLD START 20A(t _{width} =260μs measured at 50% I _{peak}) at 230VAC					
LEAKAGE CURRENT	< 0.5mA / 240VAC						
PROTECTION	SHORT CIRCUIT	Constant current limiting, recovers automatically after fault condition is removed					
	OVER TEMPERATURE	Shut down o/p voltage, recovers automatically after temperature goes down					
FUNCTION	DIMMING	Please refer to "Dimming Operation" section					
	SYNCHRONIZATION	Please refer to "Synchronization Operation" section					
ENVIRONMENT	WORKING TEMP.	-30 ~ +60°C (Please refer to "Derating Curve" section)					
	WORKING HUMIDITY	20 ~ 90% RH non-condensing					
	STORAGE TEMP., HUMIDITY	-40 ~ +80°C, 10 ~ 95% RH					
	TEMP. COEFFICIENT	± 0.03%/°C (0 ~ 50°C)					
	VIBRATION	10 ~ 500Hz, 2G 10min./1cycle, period for 60min. each along X, Y, Z axes					
SAFETY & EMC	SAFETY STANDARDS	UL8750, CSA C22.2 NO.250.0-08, ENEC EN61347-1, EN61347-2-13, EN62384 independent approved					
	DALI STANDARDS	Comply with IEC62386-101,102,207					
	WITHSTAND VOLTAGE	I/P-O/P:3.75KVAC ; I/P-DA ±:1.875KVAC ; O/P-DA ±:1.875KVAC					
	ISOLATION RESISTANCE	I/P-O/P:>100M Ohms / 500VDC / 25°C / 70% RH					
	EMC EMISSION	Compliance to EN55015, EN61000-3-2 Class C(≥ 50% load) ; EN61000-3-3					
OTHERS	EMC IMMUNITY	Compliance to EN61000-4-2,3,4,5,6,8,11, EN55024, EN61547 light industry level (surge 2KV), criteria A					
	MTBF	213.3K hrs min.	MIL-HDBK-217F (25°C)				
	DIMENSION	105*68*23mm (L*W*H)					
	PACKING	0.17Kg ; 72pcs/13.2Kg/1.04CUFT					
NOTE	1. All parameters NOT specially mentioned are measured at 230VAC input, rated load and 25°C of ambient temperature. 2. Ripple & noise are measured at 20MHz of bandwidth by using a 12" twisted pair-wire terminated with a 0.1uf & 47uf parallel capacitor. 3. Please refer to "DIP Switch Table" section. 4. Derating may be needed under low input voltage. Please check the static characteristics for more details. 5. Length of set up time is measured at first cold start. Turning ON/OFF the power supply may lead to increase of the set up time. 6. Efficiency is measured at 500mA/50V output set by DIP switch. 7. No load power consumption<0.5W is measured at 230VAC, with lighting fixture connected and output current dimmed to 0%. 8. The power supply is considered as a component that will be operated in combination with final equipment. Since EMC performance will be affected by the complete installation, the final equipment manufacturers must re-qualify EMC Directive on the complete installation again.						

■ Block Diagram

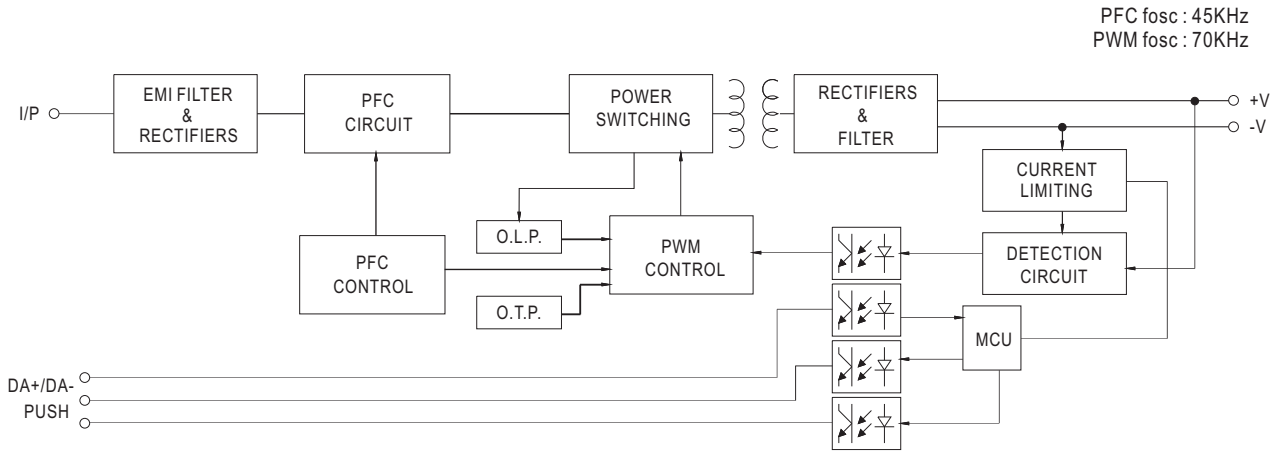

■ Derating Curve

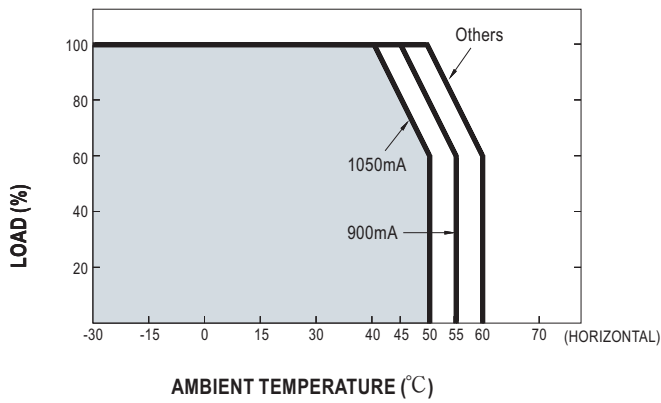

■ Static Characteristics

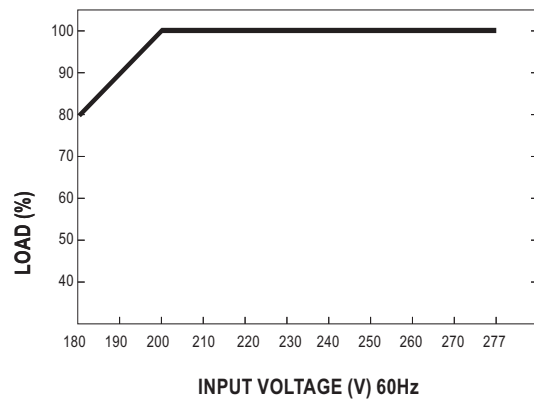

■ DIP Switch Table

LCM-25DA is a multiple-stage output current supply, selection of output current through DIP switch as table below.

Io	DIP S.W.	1	2	3	4	5	6
350mA		----	----	----	----	----	----
500mA		ON	----	----	----	----	----
600mA		ON	ON	----	----	----	----
700mA(Factory Setting)		ON	ON	ON	----	----	ON
900mA		ON	ON	ON	ON	----	ON
1050mA		ON	ON	ON	ON	ON	ON

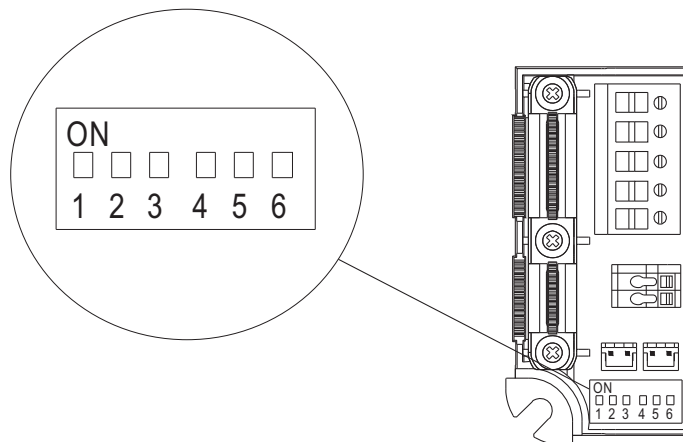

Power Factor Characteristic

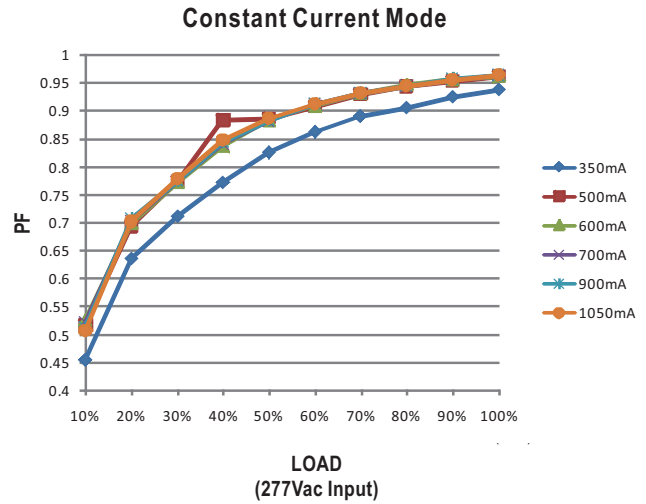
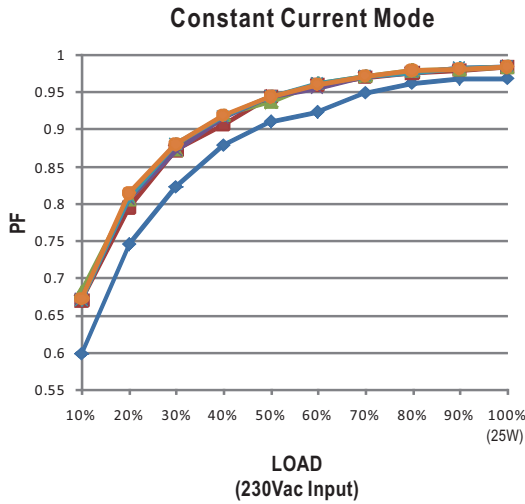

Total Harmonic Distortion Characteristic

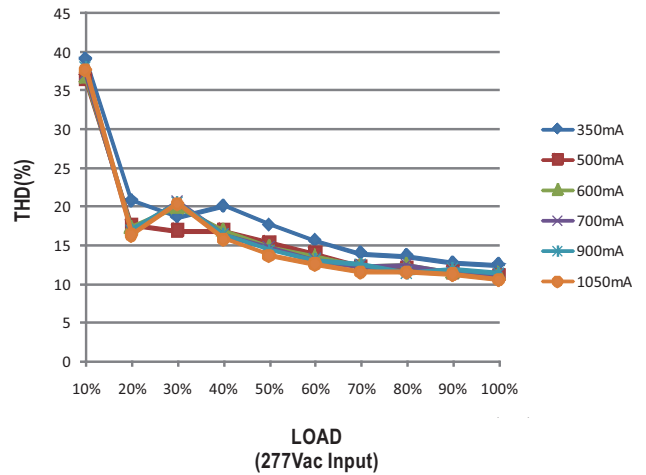
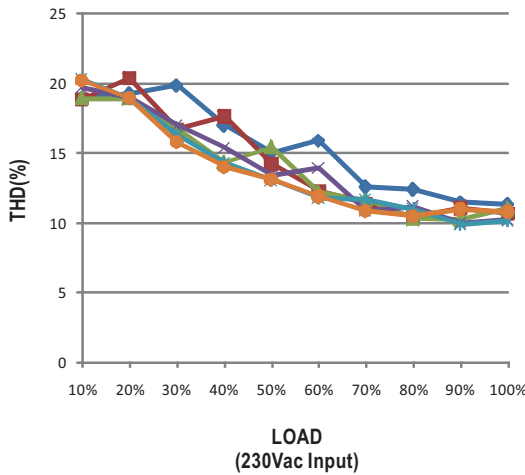

Efficiency vs Load

LCM-25DA possess superior working efficiency that up to 86% can be reached in field applications.

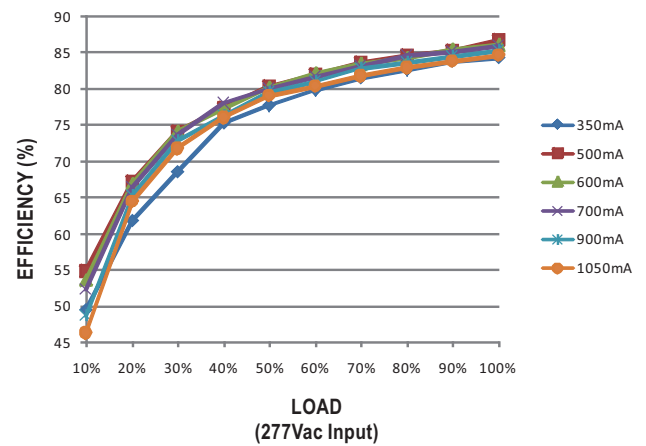
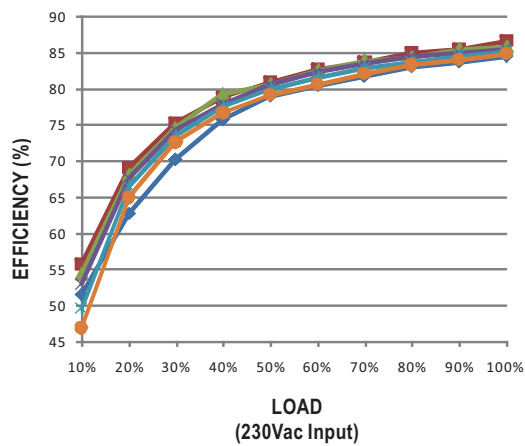

■ Dimming Operation

※ PUSH dim(primary side)

Ignore	To avoid reaction on AC spike	<0.05 sec.
Short push	Push to turn ON-OFF	0.1~1 sec.
Long push	Dimming up or down	1.5~10 sec.
Reset push	Setting light to 100%	>11 sec.

- Maximum number of drivers up to 10 pcs.
- Maximum length of the cable, from push button to the last driver is 135 meters.
- Factory setting at 100%.
- Every long pushing action will change the dimming direction.

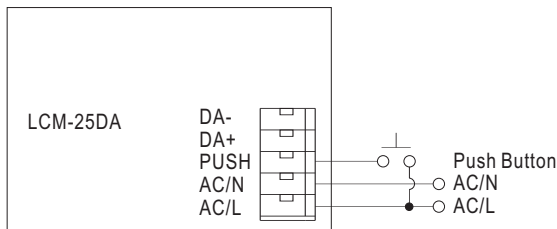

Warning: The push button can only be connected in between the PUSH terminal of LCM-25DA and AC/L (brown or black color). It would cause short circuit if it is connected to AC/N.

※ DALI interface(primary side)

- DALI protocol including 16 groups and 64 addresses.
- First step is fixed at 6% of output.
- Maximum DALI cable length is 300 meters.(based on a 1.5 mm² or 14 AWG cable)

■ Synchronization Operation

- 10 drivers(max.) synchronization (1 master + 9 slaves).
- Maximum cable length between each units : 20 meters.
- Maximum cable length from the master unit to each end of the last slave units : 120 meters.

※ Please make sure all units are set to 100% dimming setting (factory default) before synchronization.

- The lighting units driven by LCM units(Slaves) can be dimmed synchronously through a LCM unit(the master) directly controlled via DALI or push dim dimming function. The wiring is shown as follows.

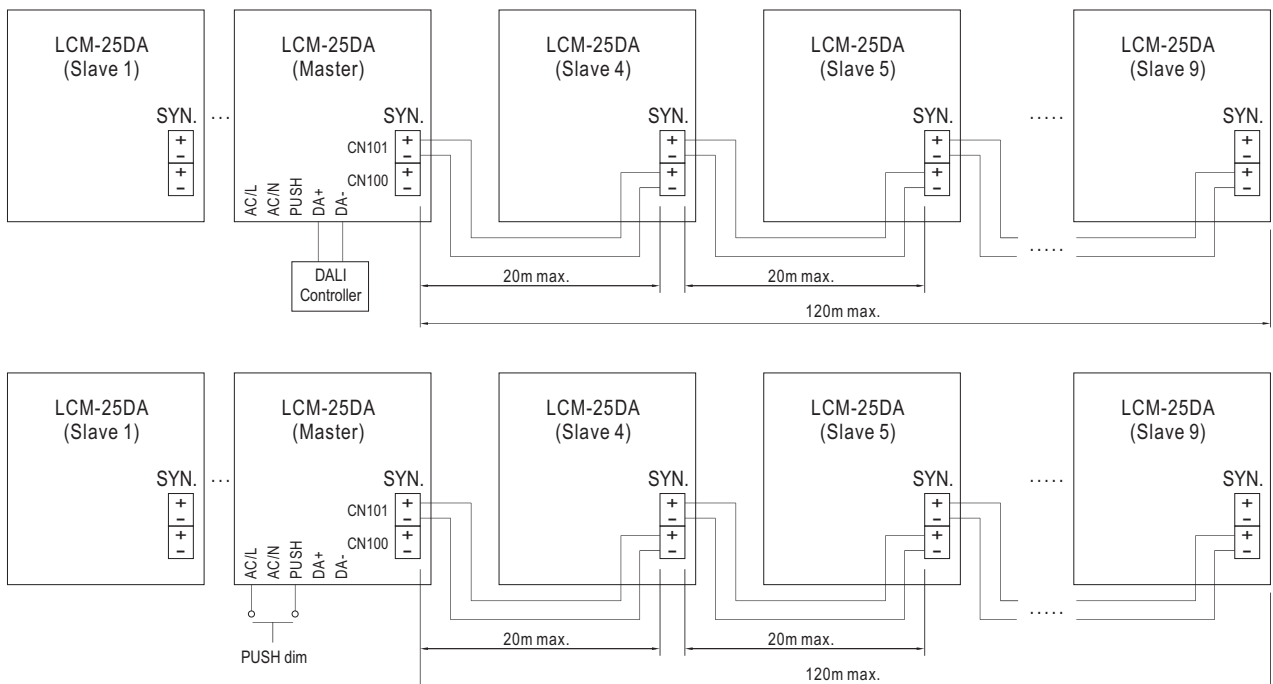

- CN100, CN101 : used to synchronously control the LCM units in parallel.

Mechanical Specification

Case No. LCM-25 Unit:mm

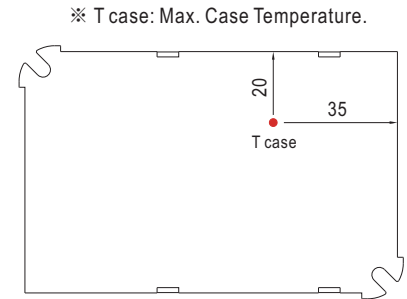
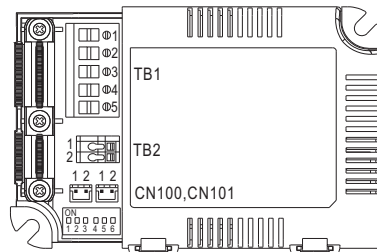
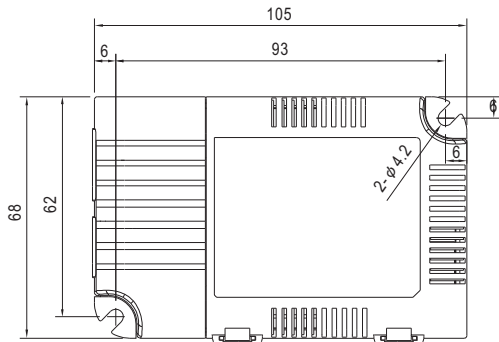

Bottom View

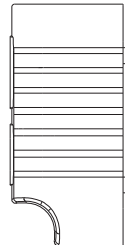
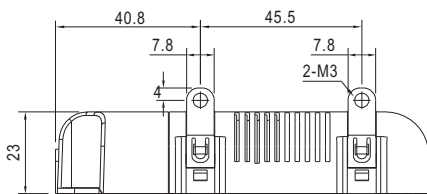

Terminal Pin No. Assignment(TB2)

Pin No.	Assignment
1	+Vo
2	-Vo

SYN. Connector(CN100/CN101):JST B2B-PH-KL or equivalent

Pin No.	Assignment	Mating Housing	Terminal
1	-	JST PHR-2 or equivalent	JST SPH-002T-P0.5S or equivalent
2	+		

Terminal Pin No. Assignment(TB1)

Pin No.	Assignment	Pin No.	Assignment
1	AC/L	4	DA+
2	AC/N	5	DA-
3	PUSH		

Note:Please use wires with a cross section of 0.5~2.5mm²(14~20AWG) for TB1 and wires with a cross section of 0.5~1.5 mm²(16~20AWG) for TB2. Please use wires with a cross section of 0.126~0.205mm²(24~26AWG) for CN100/CN101

Installation Manual

Please refer to : <http://www.meanwell.com/webnet/search/InstallationSearch.html>



Стандарт Электрон Связь

Мы молодая и активно развивающаяся компания в области поставок электронных компонентов. Мы поставляем электронные компоненты отечественного и импортного производства напрямую от производителей и с крупнейших складов мира.

Благодаря сотрудничеству с мировыми поставщиками мы осуществляем комплексные и плановые поставки широчайшего спектра электронных компонентов.

Собственная эффективная логистика и склад в обеспечивает надежную поставку продукции в точно указанные сроки по всей России.

Мы осуществляем техническую поддержку нашим клиентам и предпродажную проверку качества продукции. На все поставляемые продукты мы предоставляем гарантию .

Осуществляем поставки продукции под контролем ВП МО РФ на предприятия военно-промышленного комплекса России , а также работаем в рамках 275 ФЗ с открытием отдельных счетов в уполномоченном банке. Система менеджмента качества компании соответствует требованиям ГОСТ ISO 9001.

Минимальные сроки поставки, гибкие цены, неограниченный ассортимент и индивидуальный подход к клиентам являются основой для выстраивания долгосрочного и эффективного сотрудничества с предприятиями радиоэлектронной промышленности, предприятиями ВПК и научно-исследовательскими институтами России.

С нами вы становитесь еще успешнее!

Наши контакты:

Телефон: +7 812 627 14 35

Электронная почта: sales@st-electron.ru

Адрес: 198099, Санкт-Петербург,
Промышленная ул, дом № 19, литера Н,
помещение 100-Н Офис 331