

NTMFS5H400NL

Power MOSFET

40 V, 0.80 mΩ, 330 A, Single N-Channel

Features

- Small Footprint (5x6 mm) for Compact Design
- Low $R_{DS(on)}$ to Minimize Conduction Losses
- Low Q_G and Capacitance to Minimize Driver Losses
- These Devices are Pb-Free and are RoHS Compliant

MAXIMUM RATINGS ($T_J = 25^\circ\text{C}$ unless otherwise noted)

Parameter	Symbol	Value	Unit
Drain-to-Source Voltage	V_{DSS}	40	V
Gate-to-Source Voltage	V_{GS}	± 20	V
Continuous Drain Current $R_{\theta JC}$ (Notes 1, 3)	Steady State	$T_C = 25^\circ\text{C}$	I_D 330 A
		$T_C = 100^\circ\text{C}$	210
Power Dissipation $R_{\theta JC}$ (Note 1)	Steady State	$T_C = 25^\circ\text{C}$	P_D 160 W
		$T_C = 100^\circ\text{C}$	66
Continuous Drain Current $R_{\theta JA}$ (Notes 1, 2, 3)	Steady State	$T_A = 25^\circ\text{C}$	I_D 46 A
		$T_A = 100^\circ\text{C}$	29
Power Dissipation $R_{\theta JA}$ (Notes 1 & 2)	Steady State	$T_A = 25^\circ\text{C}$	P_D 3.3 W
		$T_A = 100^\circ\text{C}$	1.3
Pulsed Drain Current	$T_A = 25^\circ\text{C}, t_p = 10 \mu\text{s}$	I_{DM} 900	A
Operating Junction and Storage Temperature	T_J, T_{stg}	-55 to +150	$^\circ\text{C}$
Source Current (Body Diode)	I_S	180	A
Single Pulse Drain-to-Source Avalanche Energy ($I_{L(pk)} = 49 \text{ A}$)	E_{AS}	360	mJ
Lead Temperature for Soldering Purposes (1/8" from case for 10 s)	T_L	260	$^\circ\text{C}$

Stresses exceeding those listed in the Maximum Ratings table may damage the device. If any of these limits are exceeded, device functionality should not be assumed, damage may occur and reliability may be affected.

THERMAL RESISTANCE MAXIMUM RATINGS

Parameter	Symbol	Value	Unit
Junction-to-Case – Steady State	$R_{\theta JC}$	0.76	$^\circ\text{C}/\text{W}$
Junction-to-Ambient – Steady State (Note 2)	$R_{\theta JA}$	38	

1. The entire application environment impacts the thermal resistance values shown, they are not constants and are only valid for the particular conditions noted.
2. Surface-mounted on FR4 board using a 650 mm², 2 oz. Cu pad.
3. Maximum current for pulses as long as 1 second is higher but is dependent on pulse duration and duty cycle.



ON Semiconductor®

www.onsemi.com

$V_{(BR)DSS}$	$R_{DS(ON)} \text{ MAX}$	$I_D \text{ MAX}$
40 V	0.80 mΩ @ 10 V	330 A
	1.1 mΩ @ 4.5 V	

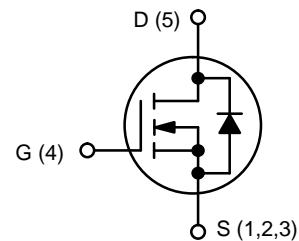

N-CHANNEL MOSFET

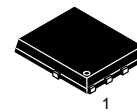

DFN5 (SO-8FL) CASE 488AA STYLE 1

MARKING DIAGRAM

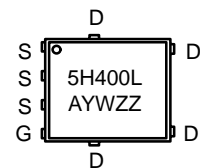

5H400L = Specific Device Code
 A = Assembly Location
 Y = Year
 W = Work Week
 ZZ = Lot Traceability

ORDERING INFORMATION

See detailed ordering, marking and shipping information on page 5 of this data sheet.

NTMFS5H400NL

ELECTRICAL CHARACTERISTICS (T_J = 25°C unless otherwise specified)

Parameter	Symbol	Test Condition	Min	Typ	Max	Unit
OFF CHARACTERISTICS						
Drain-to-Source Breakdown Voltage	V _{(BR)DSS}	V _{GS} = 0 V, I _D = 250 μA	40			V
Drain-to-Source Breakdown Voltage Temperature Coefficient	V _{(BR)DSS} /T _J			11.9		mV/°C
Zero Gate Voltage Drain Current	I _{DSS}	V _{GS} = 0 V, V _{DS} = 40 V	T _J = 25 °C		10	μA
			T _J = 125°C		250	
Gate-to-Source Leakage Current	I _{GSS}	V _{DS} = 0 V, V _{GS} = 20 V			100	nA

ON CHARACTERISTICS (Note 4)

Gate Threshold Voltage	V _{GS(TH)}	V _{GS} = V _{DS} , I _D = 250 μA	1.2		2.0	V
Threshold Temperature Coefficient	V _{GS(TH)} /T _J			-4.8		mV/°C
Drain-to-Source On Resistance	R _{DS(on)}	V _{GS} = 10 V	I _D = 50 A	0.60	0.80	mΩ
		V _{GS} = 4.5 V	I _D = 50 A	0.85	1.1	
Forward Transconductance	g _{FS}	V _{DS} = 15 V, I _D = 50 A		350		S

CHARGES, CAPACITANCES & GATE RESISTANCE

Input Capacitance	C _{ISS}	V _{GS} = 0 V, f = 1 MHz, V _{DS} = 20 V		7700		pF
Output Capacitance	C _{OSS}			1800		
Reverse Transfer Capacitance	C _{RSS}			87		
Output Charge	Q _{OSS}	V _{GS} = 0 V, V _{DD} = 20 V		80		nC
Total Gate Charge	Q _{G(TOT)}	V _{GS} = 4.5 V, V _{DS} = 20 V; I _D = 50 A		54		nC
Total Gate Charge	Q _{G(TOT)}	V _{GS} = 10 V, V _{DS} = 20 V; I _D = 50 A		120		
Threshold Gate Charge	Q _{G(TH)}	V _{GS} = 4.5 V, V _{DS} = 20 V; I _D = 50 A		11		
Gate-to-Source Charge	Q _{GS}			20		
Gate-to-Drain Charge	Q _{GD}			13		
Plateau Voltage	V _{GP}			2.7		V

SWITCHING CHARACTERISTICS (Note 5)

Turn-On Delay Time	t _{d(ON)}	V _{GS} = 4.5 V, V _{DS} = 20 V, I _D = 50 A, R _G = 1.0 Ω		20		ns
Rise Time	t _r			140		
Turn-Off Delay Time	t _{d(OFF)}			51		
Fall Time	t _f			17		

DRAIN-SOURCE DIODE CHARACTERISTICS

Forward Diode Voltage	V _{SD}	V _{GS} = 0 V, I _S = 50 A	T _J = 25°C		0.76	1.2	V
			T _J = 125°C		0.6		
Reverse Recovery Time	t _{RR}	V _{GS} = 0 V, di _S /dt = 100 A/μs, I _S = 50 A		66		ns	
Charge Time	t _a			35			
Discharge Time	t _b			31			
Reverse Recovery Charge	Q _{RR}			100			nC

Product parametric performance is indicated in the Electrical Characteristics for the listed test conditions, unless otherwise noted. Product performance may not be indicated by the Electrical Characteristics if operated under different conditions.

4. Pulse Test: pulse width ≤ 300 μs, duty cycle ≤ 2%.

5. Switching characteristics are independent of operating junction temperatures.

NTMFS5H400NL

TYPICAL CHARACTERISTICS

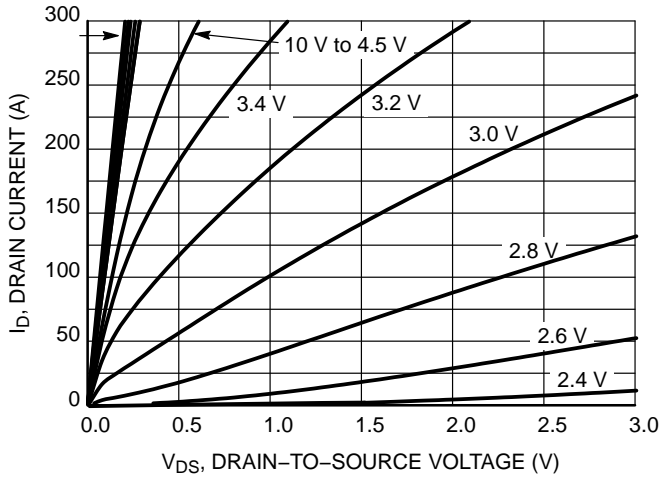

Figure 1. On-Region Characteristics

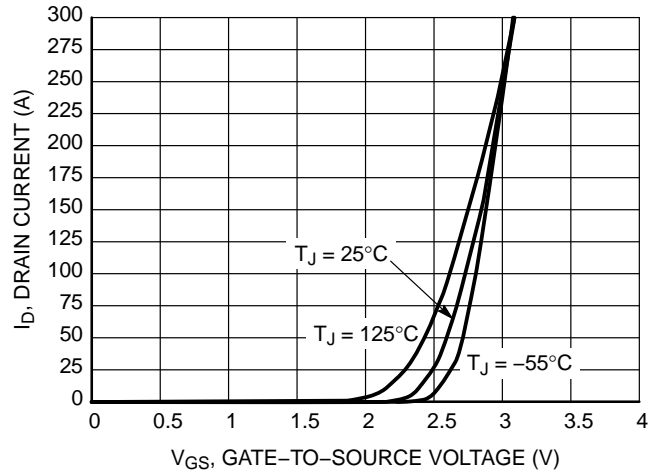

Figure 2. Transfer Characteristics

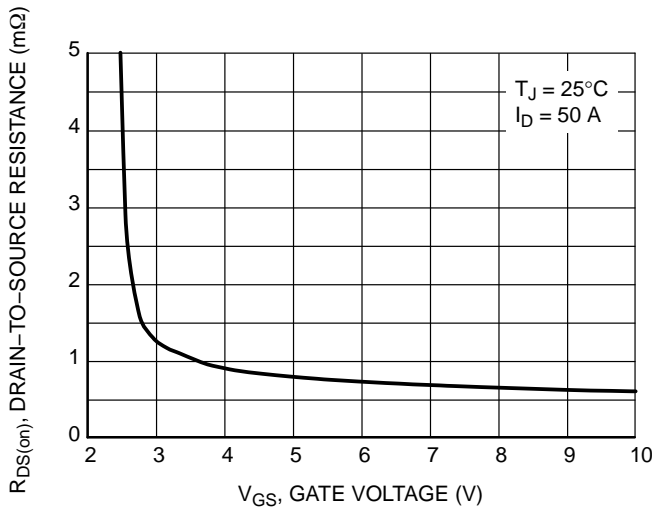

Figure 3. On-Resistance vs. Gate-to-Source Voltage

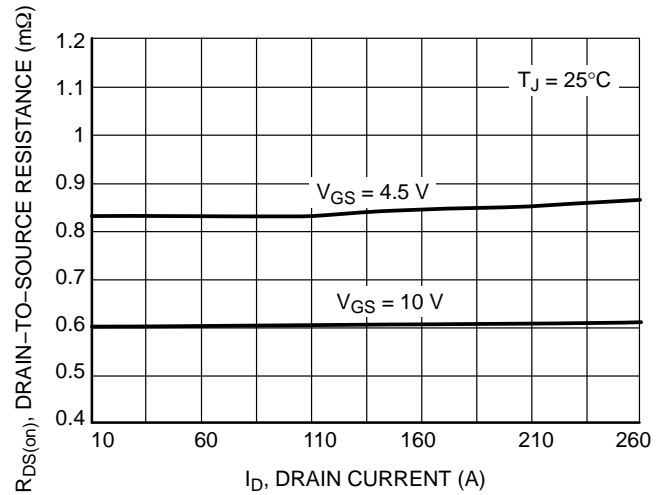

Figure 4. On-Resistance vs. Drain Current and Gate Voltage

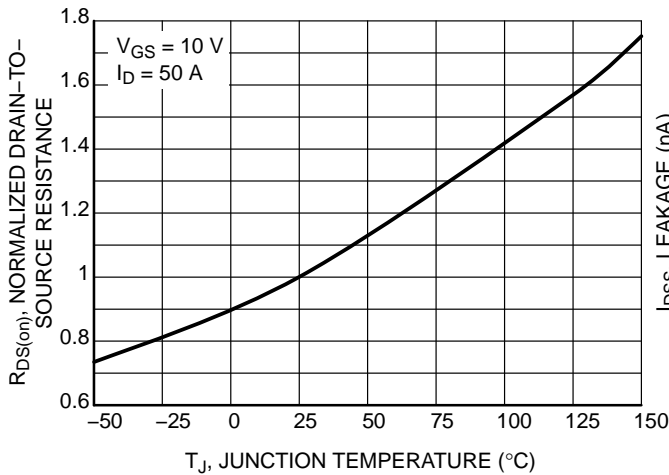

Figure 5. On-Resistance Variation with Temperature

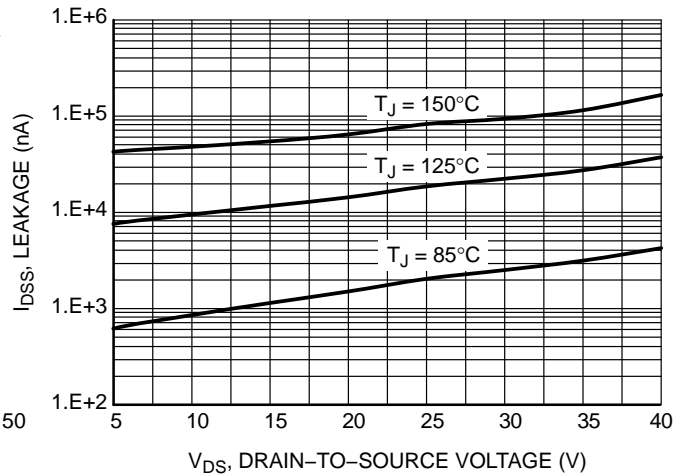

Figure 6. Drain-to-Source Leakage Current vs. Voltage

NTMFS5H400NL

TYPICAL CHARACTERISTICS

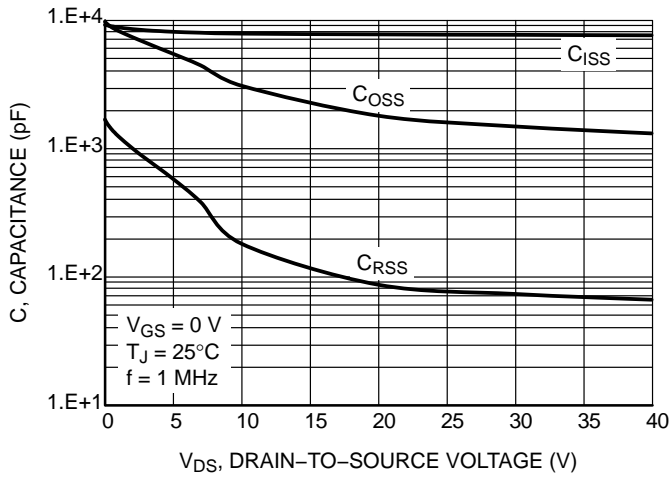

Figure 7. Capacitance Variation

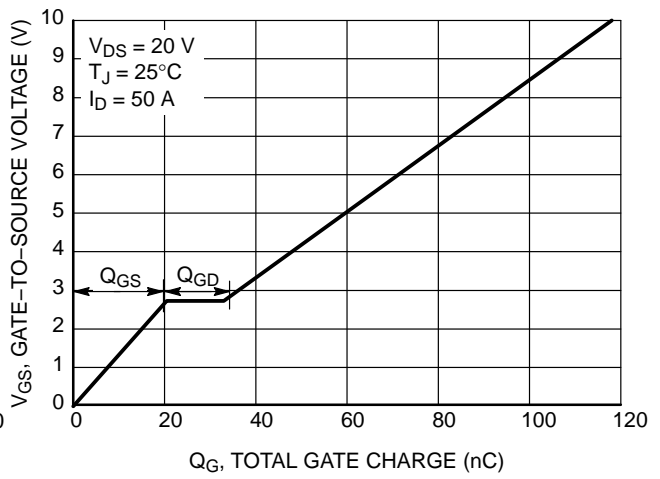

Figure 8. Gate-to-Source vs. Total Charge

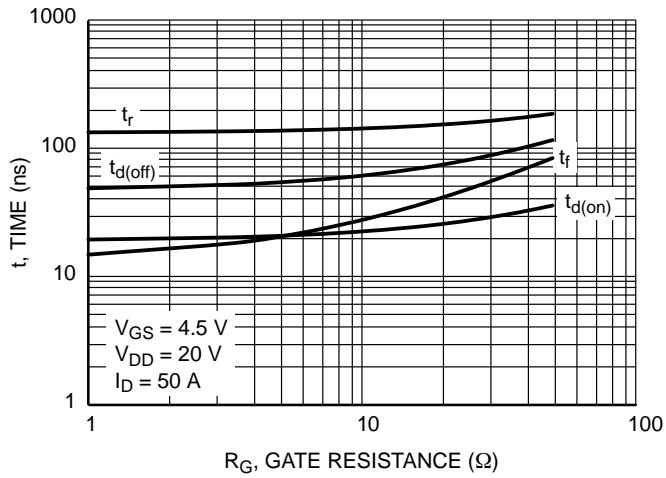

Figure 9. Resistive Switching Time Variation vs. Gate Resistance

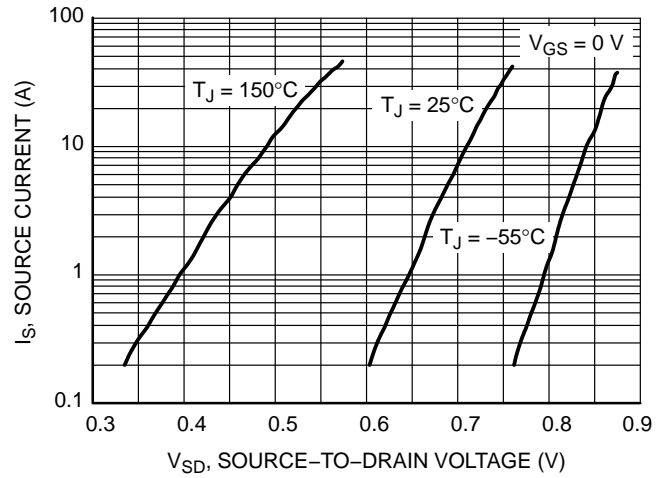

Figure 10. Diode Forward Voltage vs. Current

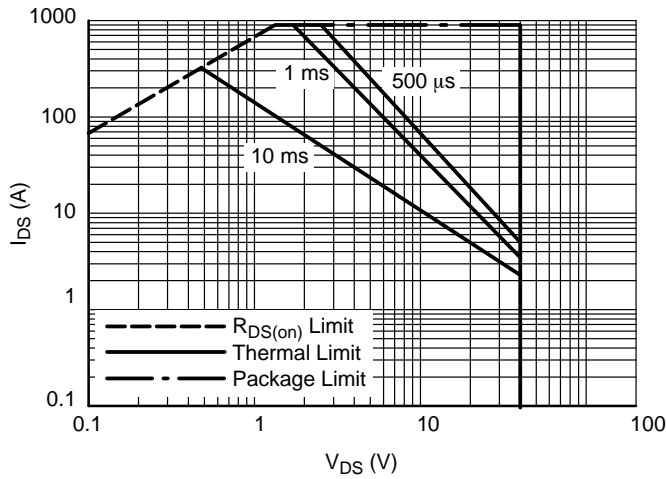

Figure 11. Safe Operating Area

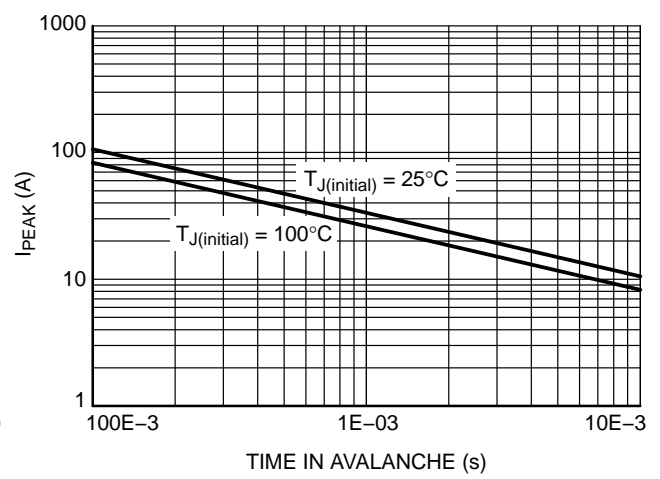

Figure 12. I_{PEAK} vs. Time in Avalanche

NTMFS5H400NL

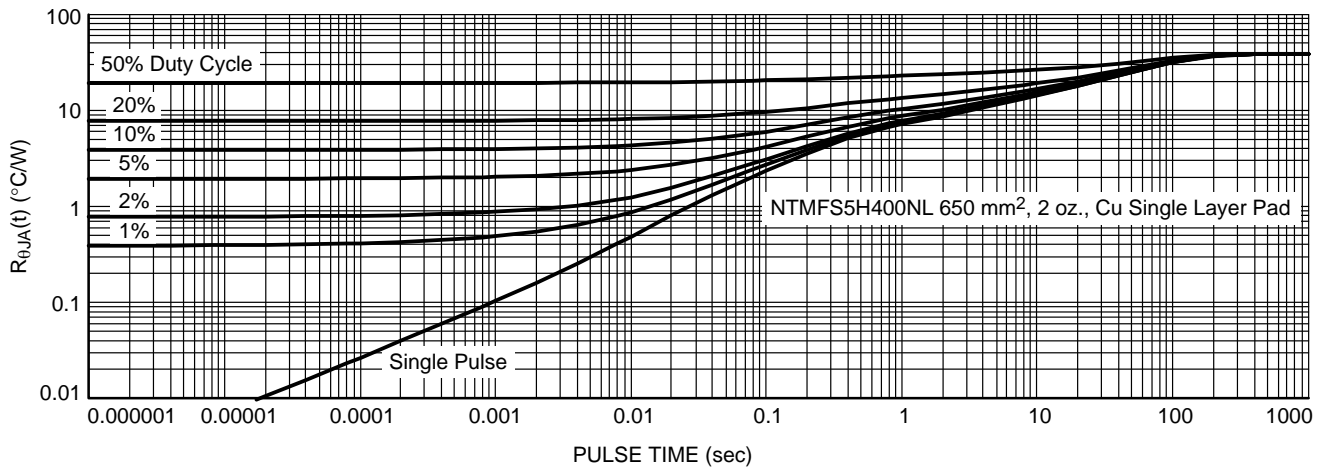

Figure 13. Thermal Characteristics

DEVICE ORDERING INFORMATION

Device	Marking	Package	Shipping†
NTMFS5H400NLT1G	5H400L	DFN5 (Pb-Free)	1500 / Tape & Reel
NTMFS5H400NLT3G	5H400L	DFN5 (Pb-Free)	5000 / Tape & Reel

†For information on tape and reel specifications, including part orientation and tape sizes, please refer to our Tape and Reel Packaging Specifications Brochure, BRD8011/D.

NTMFS5H400NL

PACKAGE DIMENSIONS

DFN5 5x6, 1.27P
(SO-8FL)
CASE 488AA
ISSUE M

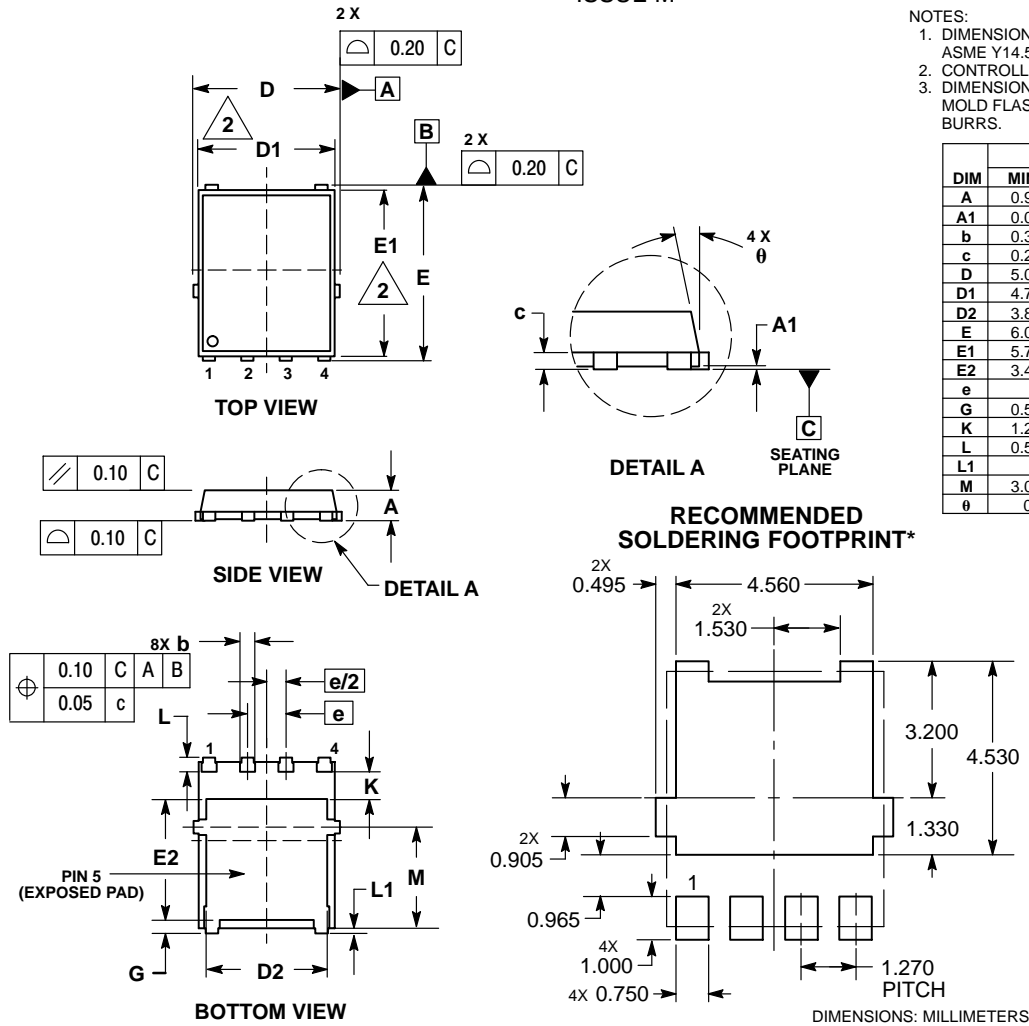

NOTES:

1. DIMENSIONING AND TOLERANCING PER ASME Y14.5M, 1994.
2. CONTROLLING DIMENSION: MILLIMETER.
3. DIMENSION D1 AND E1 DO NOT INCLUDE MOLD FLASH PROTRUSIONS OR GATE BURRS.

STYLE 1:

1. SOURCE
2. SOURCE
3. SOURCE
4. GATE
5. DRAIN

*For additional information on our Pb-Free strategy and soldering details, please download the ON Semiconductor Soldering and Mounting Techniques Reference Manual, SOLDERRM/D.

ON Semiconductor and the are registered trademarks of Semiconductor Components Industries, LLC (SCILLC) or its subsidiaries in the United States and/or other countries. SCILLC owns the rights to a number of patents, trademarks, copyrights, trade secrets, and other intellectual property. A listing of SCILLC's product/patent coverage may be accessed at www.onsemi.com/site/pdf/Patent-Marketing.pdf. SCILLC reserves the right to make changes without further notice to any products herein. SCILLC makes no warranty, representation or guarantee regarding the suitability of its products for any particular purpose, nor does SCILLC assume any liability arising out of the application or use of any product or circuit, and specifically disclaims any and all liability, including without limitation special, consequential or incidental damages. "Typical" parameters which may be provided in SCILLC data sheets and/or specifications can and do vary in different applications and actual performance may vary over time. All operating parameters, including "Typicals" must be validated for each customer application by customer's technical experts. SCILLC does not convey any license under its patent rights nor the rights of others. SCILLC products are not designed, intended, or authorized for use as components in systems intended for surgical implant into the body, or other applications intended to support or sustain life, or for any other application in which the failure of the SCILLC product could create a situation where personal injury or death may occur. Should Buyer purchase or use SCILLC products for any such unintended or unauthorized application, Buyer shall indemnify and hold SCILLC and its officers, employees, subsidiaries, affiliates, and distributors harmless against all claims, costs, damages, and expenses, and reasonable attorney fees arising out of, directly or indirectly, any claim of personal injury or death associated with such unintended or unauthorized use, even if such claim alleges that SCILLC was negligent regarding the design or manufacture of the part. SCILLC is an Equal Opportunity/Affirmative Action Employer. This literature is subject to all applicable copyright laws and is not for resale in any manner.

PUBLICATION ORDERING INFORMATION

LITERATURE FULFILLMENT:

Literature Distribution Center for ON Semiconductor
19521 E. 32nd Pkwy, Aurora, Colorado 80011 USA
Phone: 303-675-2175 or 800-344-3860 Toll Free USA/Canada
Fax: 303-675-2176 or 800-344-3867 Toll Free USA/Canada
Email: orderlit@onsemi.com

N. American Technical Support: 800-282-9855 Toll Free USA/Canada
Europe, Middle East and Africa Technical Support: Phone: 421 33 790 2910
Japan Customer Focus Center Phone: 81-3-5817-1050

ON Semiconductor Website: www.onsemi.com

Order Literature: <http://www.onsemi.com/orderlit>

For additional information, please contact your local Sales Representative



Стандарт Электрон Связь

Мы молодая и активно развивающаяся компания в области поставок электронных компонентов. Мы поставляем электронные компоненты отечественного и импортного производства напрямую от производителей и с крупнейших складов мира.

Благодаря сотрудничеству с мировыми поставщиками мы осуществляем комплексные и плановые поставки широчайшего спектра электронных компонентов.

Собственная эффективная логистика и склад в обеспечивает надежную поставку продукции в точно указанные сроки по всей России.

Мы осуществляем техническую поддержку нашим клиентам и предпродажную проверку качества продукции. На все поставляемые продукты мы предоставляем гарантию .

Осуществляем поставки продукции под контролем ВП МО РФ на предприятия военно-промышленного комплекса России , а также работаем в рамках 275 ФЗ с открытием отдельных счетов в уполномоченном банке. Система менеджмента качества компании соответствует требованиям ГОСТ ISO 9001.

Минимальные сроки поставки, гибкие цены, неограниченный ассортимент и индивидуальный подход к клиентам являются основой для выстраивания долгосрочного и эффективного сотрудничества с предприятиями радиоэлектронной промышленности, предприятиями ВПК и научно-исследовательскими институтами России.

С нами вы становитесь еще успешнее!

Наши контакты:

Телефон: +7 812 627 14 35

Электронная почта: sales@st-electron.ru

Адрес: 198099, Санкт-Петербург,
Промышленная ул, дом № 19, литера Н,
помещение 100-Н Офис 331