

3mm (T1) Package Discrete LED GREEN, Ultra Bright

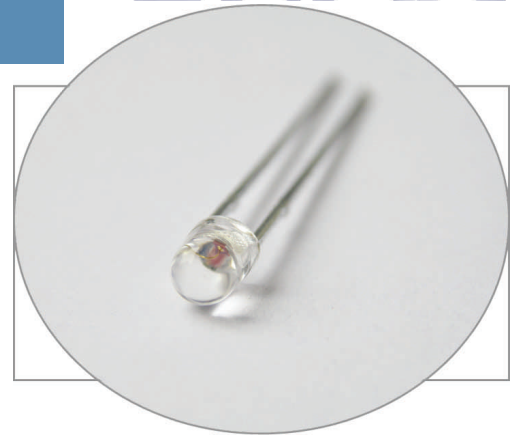

3SUGC-X

- ◆ Industry Standard 3mm (T1) Package
- ◆ RoHS Compliant
- ◆ Water Clear Lens
- ◆ Available in Flange (F), Standard (Blank), and Shouldered (S) Lead Frame styles
- ◆ Up to 300 mcd Luminous Intensity at 20 mA
- ◆ Ideal for Back Lighting, Status Indication, and Display
- ◆ Recommended for Bivar Flexible Light Pipe assemblies

Bivar 3mm T1 Package Ultra Bright LED is ideal for those applications where intensive ambient lighting exists such as Back Lighting, Signage, and Sunlight Readable applications. Bivar offers water clear LED lens for maximum light output. The Flanged LED is ideal for Panel Mount Clip & Ring assemblies, the Standard Lead frame LED is ideal for vertical spacer assemblies without lead bends, and the Shouldered Lead frame LED has a built in strain relief feature which is ideal for Right Angle Holder assemblies that require lead bends. A long lead version is also available with a “-LL” suffix added to the part numbers.

Part Number	Material	Emitted Color	Peak. Wavelength λ_p (nm) TYP.	Lens Appearance	Viewing Angle
3SUGC-F	AlGaInP	GREEN	570nm	Water Clear	20°
3SUGC				Water Clear	30°
3SUGC-S				Water Clear	30°

Part Number Designation



Bivar reserves the right to make changes at any time without notice.

3mm (T1) Package Discrete LED GREEN, Ultra Bright



Outline Dimensions

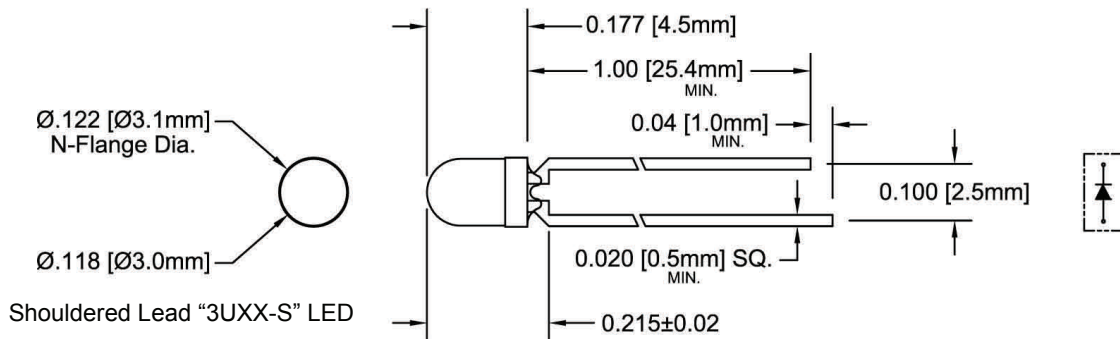

Recommended Mounting
Hole Size = $\varnothing.032^{+.003}_{-.002}$

NOTE: Add suffix -LL for long lead.
Changes 1.00 Min. to 1.57 Min.
Standard Lead Only

- Outline Drawings Notes:**
1. All dimensions are in inches [millimeters].
 2. Standard tolerance: $\pm 0.010''$ unless otherwise noted.
 3. Tolerance of overall epoxy outline: $\pm 0.020''$ unless otherwise noted.
 4. Epoxy meniscus may extend to 0.060" max.

Bivar reserves the right to make changes at any time without notice.

3mm (T1) Package Discrete LED GREEN, Ultra Bright



Absolute Maximum Ratings

T_A = 25°C unless otherwise noted

Power Dissipation	100 mW
Forward Current (DC)	30 mA
Peak Forward Current ¹	150 mA
Reverse Voltage	5 V
Operating Temperature Range	-25 ~ +85°C
Storage Temperature Range	-30 ~ +100°C
Lead Soldering Temperature (3 mm from the base of the epoxy bulb) ²	260°C

Notes: 1. 10% Duty Cycle, Pulse Width ≤ 0.1 msec. 2. Solder time less than 5 seconds at temperature extreme.

Electrical / Optical Characteristics

T_A = 25°C & I_F = 20 mA unless otherwise noted

Part Number	Forward Voltage (V) ¹			Recommend Forward Current (mA)			Reverse Current (μA)	Dominant Wavelength (nm) ²			Luminous Intensity I _v (mcd)			Viewing Angle 2Θ ½ (deg)
	MIN	TYP	MAX	MIN	TYP	MAX	MAX	MIN	TYP	MAX	MIN	TYP	MAX	TYP
3SUGC-F								/	/	/	/	300	/	20
3SUGC	/	2.1	2.4	/	20	/	100	/	/	/	/	300	/	30
3SUGC-S								/	/	/	/	300	/	30

Notes: 1. Tolerance of forward voltage : ±0.05V. 2. Tolerance of dominant wavelength : ±1.0nm.

Bivar reserves the right to make changes at any time without notice.

3mm (T1) Package Discrete LED GREEN, Ultra Bright



Typical Electrical / Optical Characteristics

$T_A = 25^\circ\text{C}$ unless otherwise noted

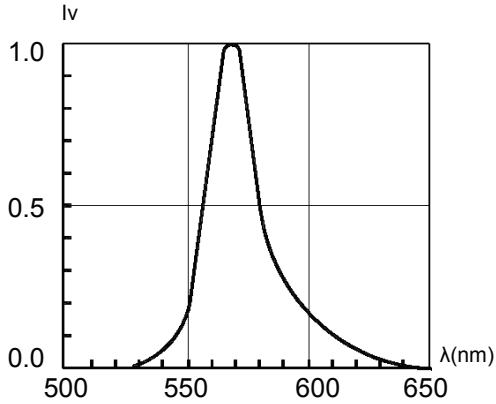

Fig. 1 Relative Luminous Intensity vs. Wavelength @ 20mA



Fig. 2 Directivity Radiation Diagram

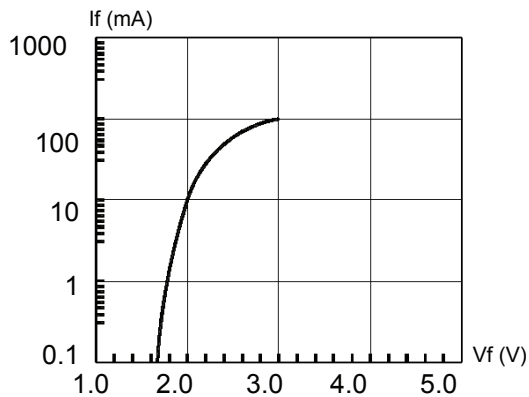

Fig. 3 Forward Current vs. Forward Voltage

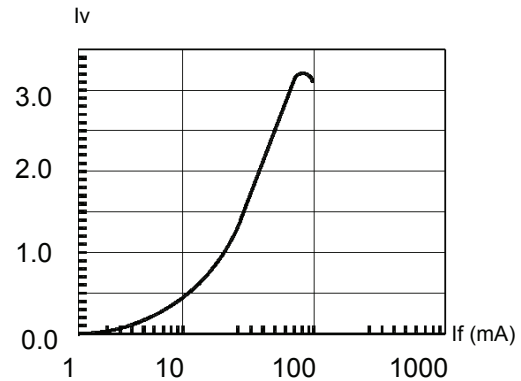

Fig. 4 Relative Luminous Intensity vs. Forward Current Normalize @ 20 mA

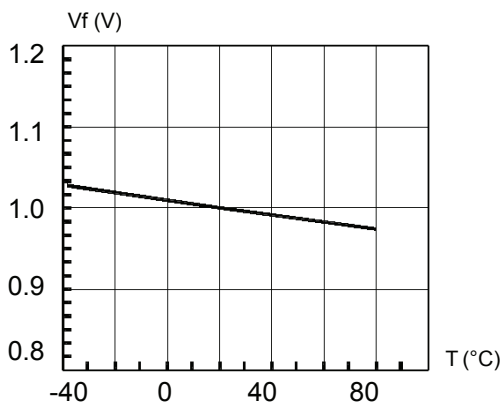

Fig. 5 Forward Voltage vs. Temperature

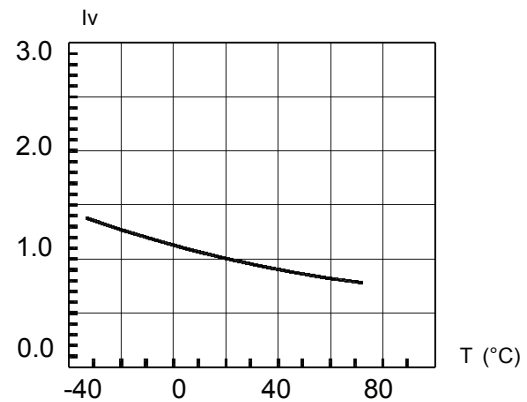

Fig. 6 Relative Luminous Intensity vs. Temperature

Bivar reserves the right to make changes at any time without notice.

3mm (T1) Package Discrete LED GREEN, Ultra Bright



Recommended Soldering Conditions

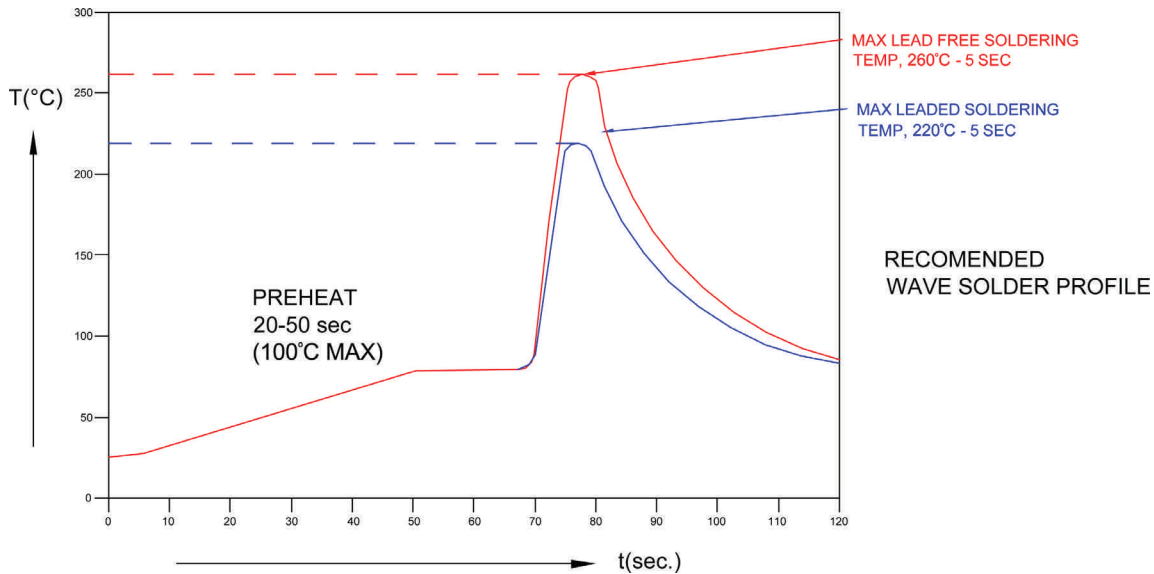

Recommended Lead Free Wave Soldering Profile	
Preheat Temperature: 100°C Max.	Peak Temperature: 260°C Max.
Preheat Time: 20 ~ 50 Seconds	Solder Time Above 217°C: 5 Seconds Max.
Note: Turn off top heater at preheat to prevent the lamp body directly exposed to the heat source.	

Packaging and Labeling Plan



Bivar, Inc.	MSL 1
4 Thomas, Irvine, CA 92618-2593	
LOT: XXX.XXXXX.XX	
Part: XXXX-XXX-XXX	
Quantity: .500	RoHS Compliant

AntiStatic Poly Bag with Desiccant
(500 pcs Max. per Bag)

Bivar reserves the right to make changes at any time without notice.



Стандарт Электрон Связь

Мы молодая и активно развивающаяся компания в области поставок электронных компонентов. Мы поставляем электронные компоненты отечественного и импортного производства напрямую от производителей и с крупнейших складов мира.

Благодаря сотрудничеству с мировыми поставщиками мы осуществляем комплексные и плановые поставки широчайшего спектра электронных компонентов.

Собственная эффективная логистика и склад в обеспечивает надежную поставку продукции в точно указанные сроки по всей России.

Мы осуществляем техническую поддержку нашим клиентам и предпродажную проверку качества продукции. На все поставляемые продукты мы предоставляем гарантию .

Осуществляем поставки продукции под контролем ВП МО РФ на предприятия военно-промышленного комплекса России , а также работаем в рамках 275 ФЗ с открытием отдельных счетов в уполномоченном банке. Система менеджмента качества компании соответствует требованиям ГОСТ ISO 9001.

Минимальные сроки поставки, гибкие цены, неограниченный ассортимент и индивидуальный подход к клиентам являются основой для выстраивания долгосрочного и эффективного сотрудничества с предприятиями радиоэлектронной промышленности, предприятиями ВПК и научно-исследовательскими институтами России.

С нами вы становитесь еще успешнее!

Наши контакты:

Телефон: +7 812 627 14 35

Электронная почта: sales@st-electron.ru

Адрес: 198099, Санкт-Петербург,
Промышленная ул, дом № 19, литера Н,
помещение 100-Н Офис 331