

MIC2033



High-Accuracy, High-Side, Fixed Current Limit Power Switch

General Description

The MIC2033 is a high-side MOSFET power distribution switch providing increased system reliability utilizing 5% current limit accuracy.

The MIC2033 has an operating input voltage range from 2.5V to 5.5V, is internally current limited and has thermal shutdown to protect the device and system. The MIC2033 is offered with either active-high or active-low logic level enable input controls, has an open drain fault status output flag with a built-in 32ms delay that asserts low during over current or thermal shutdown conditions.

The MIC2033 is available in several different fixed current limit options: 0.5A, 0.8A, 1A, and 1.2A. A capacitor adjustable soft-start circuit minimizes inrush current in applications where high capacitive loads are used.

The MIC2033 is offered in both 6-pin SOT-23 and 6-pin 2mm x 2mm thin DFN packages. The MIC2033 has an operating junction temperature range of -40°C to $+125^{\circ}\text{C}$.

Data sheets and support documentation can be found on Micrel's web site at: www.micrel.com.

Features

- $\pm 5\%$ current limit accuracy
- Input supply range from 2.5V to 5.5V
- Low quiescent current: 100 μA typical (switch ON)
- 75m Ω typical $R_{\text{DS(ON)}}$ at 5V
- Current limit options: 0.5A, 0.8A, 1A, and 1.2A
- Soft-start control via an external capacitor
- Undervoltage lockout (UVLO)
- Fast response time (10 μs) to short circuit loads
- Fault status output flag
- Logic controlled enable (active-high, active-low)
- Thermal shutdown
- Pin compatible with MIC2005
- 6-pin 2mm x 2mm thin DFN and 6-pin SOT-23 packages
- Junction temperature range from -40°C to $+125^{\circ}\text{C}$

Applications

- USB peripherals and USB 2.0/3.0 compatible
- DTV/STB
- Notebooks and consumer electronics
- General purpose power distribution

Typical Application

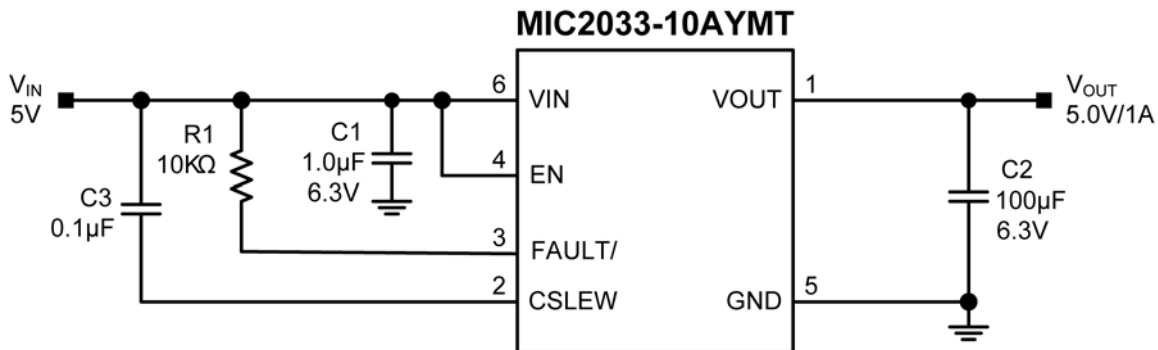

Ordering Information

Part Number	Top Mark	Current Limit	Enable	Package
MIC2033-05AYM6	<u>35A</u>	0.5A	Active High	SOT-23-6L
MIC2033-05BYM6	<u>35B</u>	0.5A	Active Low	SOT-23-6L
MIC2033-05AYMT	3A5	0.5A	Active High	6-pin 2mm x 2mm Thin DFN
MIC2033-05BYMT	3B5	0.5A	Active Low	6-pin 2mm x 2mm Thin DFN
MIC2033-55AYM6*	55A	0.55A	Active High	SOT-23-6L
MIC2033-55AYMT*	5A5	0.55A	Active High	6-pin 2mm x 2mm Thin DFN
MIC2033-08AYM6	<u>38A</u>	0.8A	Active High	SOT-23-6L
MIC2033-08BYM6	<u>38B</u>	0.8A	Active Low	SOT-23-6L
MIC2033-08AYMT	3A8	0.8A	Active High	6-pin 2mm x 2mm Thin DFN
MIC2033-08BYMT	3B8	0.8A	Active Low	6-pin 2mm x 2mm Thin DFN
MIC2033-10AYM6	<u>31A</u>	1.0A	Active High	SOT-23-6L
MIC2033-10BYM6	<u>31B</u>	1.0A	Active Low	SOT-23-6L
MIC2033-10AYMT	3A1	1.0A	Active High	6-pin 2mm x 2mm Thin DFN
MIC2033-10BYMT	3B1	1.0A	Active Low	6-pin 2mm x 2mm Thin DFN
MIC2033-12AYM6	<u>32A</u>	1.2A	Active High	SOT-23-6L
MIC2033-12BYM6	<u>32B</u>	1.2A	Active Low	SOT-23-6L
MIC2033-12AYMT	3A2	1.2A	Active High	6-pin 2mm x 2mm Thin DFN
MIC2033-12BYMT	3B2	1.2A	Active Low	6-pin 2mm x 2mm Thin DFN

Notes:

1. Under bar symbol () may not be to scale.
2. Thin DFN is a GREEN RoHS compliant package. Lead finish is NiPdAu. Mold compound is Halogen Free.
3. * Contact Micrel for availability.

Pin Configuration

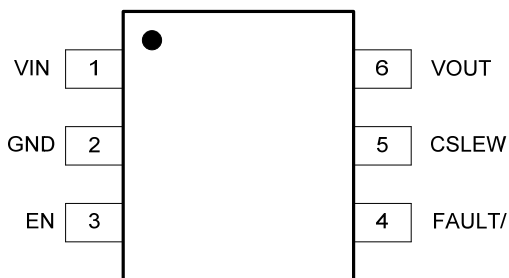

SOT-23 6-Lead (M6)

Top View

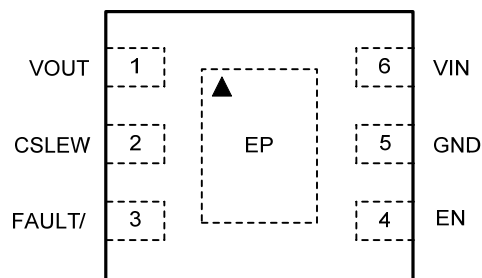

2mm x 2mm 6-pin Thin DFN (MT)

Top View

Notes:

1. Thin DFN ▲ = Pin 1 identifier.

Pin Description

Pin Number		Pin Name	Pin Function
SOT-23-6L	6-pin 2mmx2mm Thin DFN		
1	6	VIN	Input: Power switch and logic supply input.
2	5	GND	Ground: Input and output return pin.
3	4	EN	Enable (Input): Logic compatible, enable control input that allows turn-on/-off of the switch. Do not leave the EN pin floating.
4	3	FAULT/	Fault Status Flag (Output): Active-low, open-drain output. A logic LOW state indicates an over current or thermal shutdown condition. An over current condition must last longer than t_{FAULT} in order to assert FAULT/. A pull-up resistor (10k Ω recommended) to an external supply is required.
5	2	CSLEW	Slew Rate Control: Adjustable soft-start input. Adding a small value capacitor from CSLEW to VIN slows the turn-on time of the power MOSFET.
6	1	VOUT	Switch Output: Power switch output.
—	EP	ePad	Exposed Pad: Exposed pad on bottom side of package. Connect to electrical ground for optimum thermal dissipation.

Absolute Maximum Ratings⁽¹⁾

V_{IN} to GND	-0.3V to +6V
V_{OUT} to GND	-0.3V to V_{IN}
V_{CSLEW} to GND	-0.3V to +6V
V_{EN} to GND	-0.3V to +6V
$V_{FAULT/}$ to GND	-0.3V to +6V
FAULT/ Current ($I_{FAULT/}$)	25mA
Maximum Power Dissipation (P_D)	Internally Limited
Lead Temperature (soldering, 10 sec.)	260°C
Storage Temperature (T_S)	-65°C to +150°C
ESD Rating ⁽²⁾	
HBM	3kV
MM	300V

Operating Ratings⁽³⁾

Supply Voltage (V_{IN})	+2.5V to +5.5V
V_{EN} , $V_{FAULT/}$	-0.3V to +5.5V
V_{CSLEW} , V_{OUT}	-0.3V to V_{IN}
Ambient Temperature Range (T_A)	-40°C to +85°C
Junction Temperature (T_J)	-40°C to +125°C
Package Thermal Resistance	
SOT-23-6 (θ_{JA})	177.2°C/W
6-pin 2mm × 2mm DFN (θ_{JA})	90°C/W

Electrical Characteristics⁽⁴⁾

$V_{IN} = V_{EN} = 5V$; $C_{IN} = 1\mu F$; $C_{CSLEW} = 0.1\mu F$; $C_{OUT} = 1\mu F$; $T_J = 25^\circ C$. **Bold** values indicate $-40^\circ C \leq T_J \leq +125^\circ C$, unless noted.

Symbol	Parameter	Condition	Min.	Typ.	Max.	Units	
Power Supply Input							
V_{IN}	Input Voltage Range		2.5		5.5	V	
V_{UVLO}	Input Supply Under-voltage Lockout Threshold	V_{IN} rising	2.0	2.25	2.5	V	
		V_{IN} falling	1.9	2.15	2.4		
$V_{UVLOHYS}$	Input Supply Under-voltage Lockout Threshold Hysteresis	V_{IN} rising or V_{IN} falling		100		mV	
I_{DD}	Supply Current	Switch OFF ($I_{OUT} = 0A$)	Active High Enable (A): $V_{EN} = 0V$, $V_{IN} = 5V$		0.75	5	μA
			Active Low Enable (B): $V_{EN} = V_{IN} = 5V$				
		Switch ON ($I_{OUT} = 0A$)	Active High Enable (A): $V_{EN} = 1.5V$, $V_{IN} = 5V$		100	300	
			Active Low Enable (B): $V_{EN} = 0V$, $V_{IN} = 5V$				
Power MOSFET							
$R_{DS(ON)}$	Switch On-Resistance	$V_{IN} = 2.5V$, $I_{OUT} = 350mA$		100	177	m Ω	
		$V_{IN} = 3.3V$, $I_{OUT} = 350mA$		85	145		
		$V_{IN} = 5V$, $I_{OUT} = 350mA$		75	125		
I_{LKG}	Output Leakage Current	Switch Off, $V_{OUT} = 0V$		0.22	15	μA	
Current Limit							
I_{LIMIT}	Current Limit	MIC2033-05xxxx, $V_{OUT} = 0.8 \times V_{IN}$	0.475	0.50	0.525	A	
		MIC2033-55xxx, $V_{OUT} = 0.8 \times V_{IN}$ ⁽⁵⁾	0.517	0.550	0.578		
		MIC2033-08xxxx, $V_{OUT} = 0.8 \times V_{IN}$	0.76	0.80	0.84		
		MIC2033-10xxxx, $V_{OUT} = 0.8 \times V_{IN}$	0.95	1.00	1.05		
		MIC2033-12xxxx, $V_{OUT} = 0.8 \times V_{IN}$	1.14	1.20	1.26		
I/O							
V_{EN}	Enable Voltage	Logic Low			0.5	V	
		Logic High	1.5				

I_{EN}	Enable Input Current	$0V \leq V_{EN} \leq 5V$		1		μA
----------	----------------------	--------------------------	--	---	--	---------

Electrical Characteristics⁽⁴⁾ (Continued)

Symbol	Parameter	Condition	Min.	Typ.	Max.	Units
$R_{FAULT/}$	FAULT/ Output Resistance	$I_{OUT} = 10mA$			25	Ω
I_{FAULT_OFF}	FAULT/ Off Current	$V_{FAULT/} = V_{IN}$			10	μA
I_{CSLEW}	CSLEW Input Current	$V_{CSLEW} = V_{IN}$		0.6		μA
Thermal Protection						
T_{SD}	Thermal Shutdown Threshold	T_J Rising		157		$^{\circ}C$
T_{SDHYS}	Thermal Shutdown Hysteresis			15		$^{\circ}C$
Timing Specifications (AC Parameters)						
t_{RISE}	Output Turn-on Rise Time ⁽⁶⁾	$R_{LOAD} = 10\Omega; C_{OUT} = 1\mu F$		700		μs
t_{FALL}	Output Turn-off Fall Time ⁽⁶⁾	$V_{EN} = OFF; R_{LOAD} = 10\Omega; C_{OUT} = 1\mu F$		32		μs
t_{ON_DLY}	Output Turn-on Delay ⁽⁶⁾	$R_{LOAD} = 10\Omega; C_{OUT} = 1\mu F$		700		μs
t_{OFF_DLY}	Output Turn-off Delay ⁽⁶⁾	$R_{LOAD} = 10\Omega; C_{OUT} = 1\mu F$		5		μs
t_{SC_RESP}	Short Circuit Response Time ⁽⁶⁾	$V_{OUT} = 0V$ (short circuit)		10		μs
$t_{FAULT/}$	Over-current Fault Response Delay Time ⁽⁶⁾		16	32	49	ms

Notes:

1. Exceeding the absolute maximum rating may damage the device.
2. Devices are ESD sensitive. Handling precautions recommended. Human body model (HBM), 1.5k Ω in series with 100pF.
3. The device is not guaranteed to function outside its operating rating.
4. Specification for packaged product only.
5. Preliminary.
6. See Timing Diagrams (Figures 1-3).

Timing Diagrams

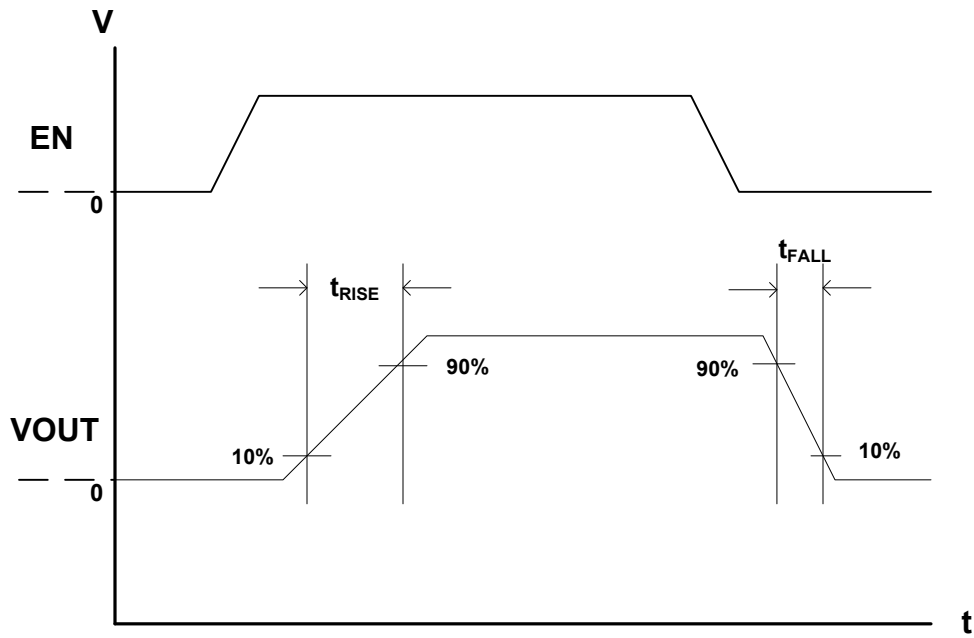

Figure 1. Output Rise/Fall Time

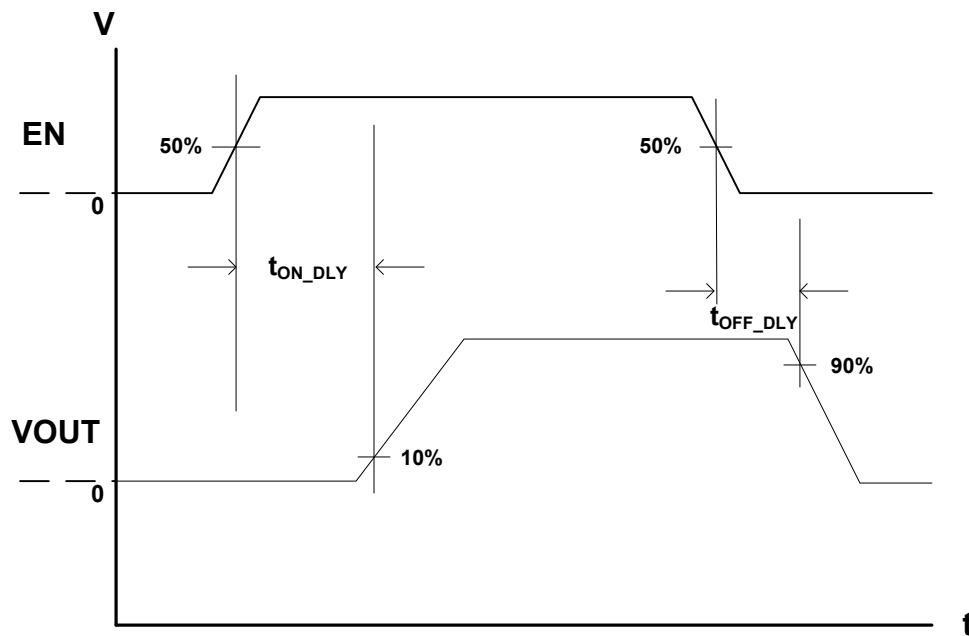

Figure 2. Turn-On/Off Delay

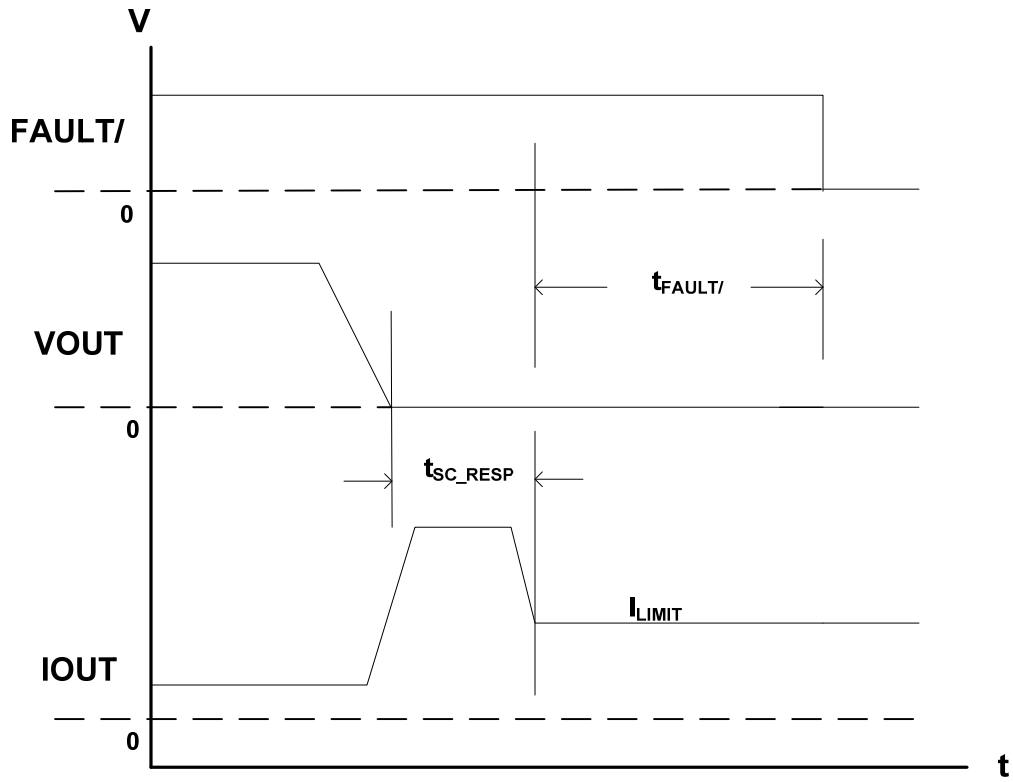
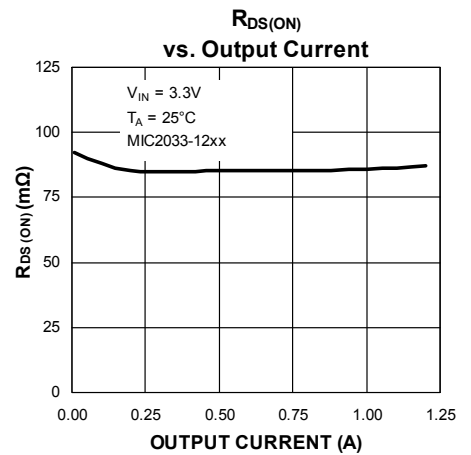
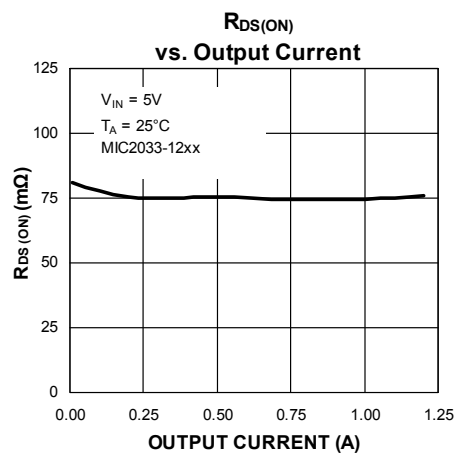
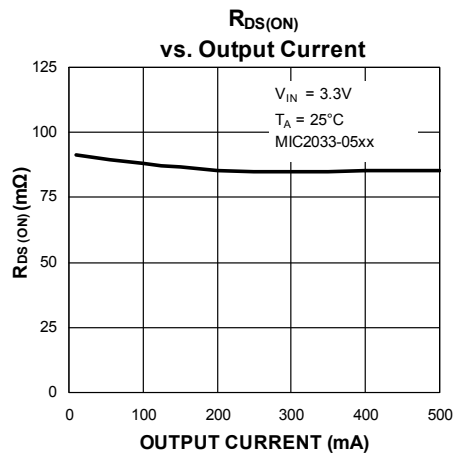
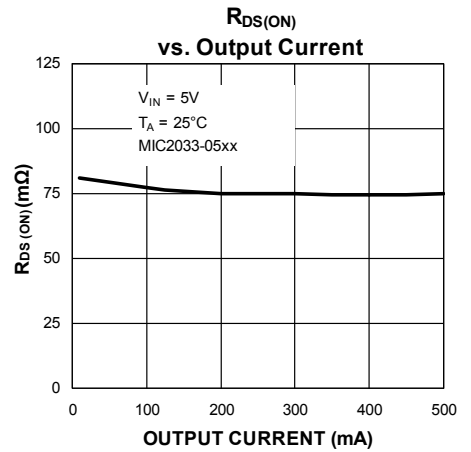
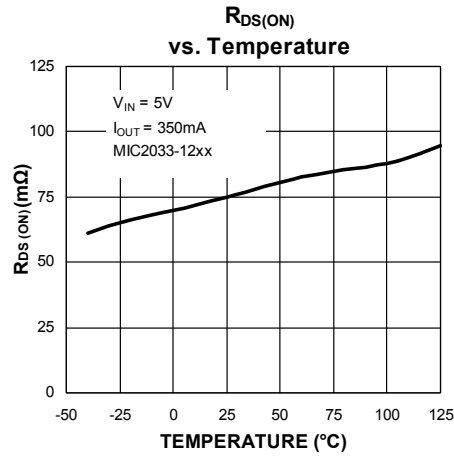
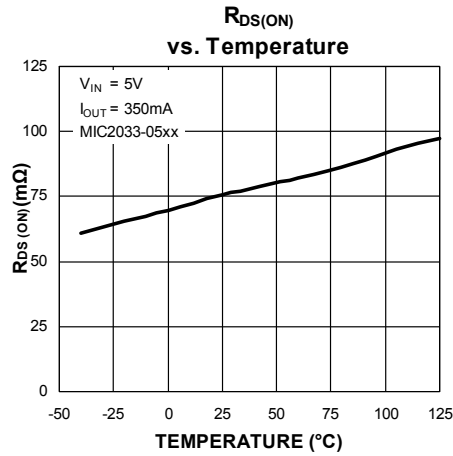
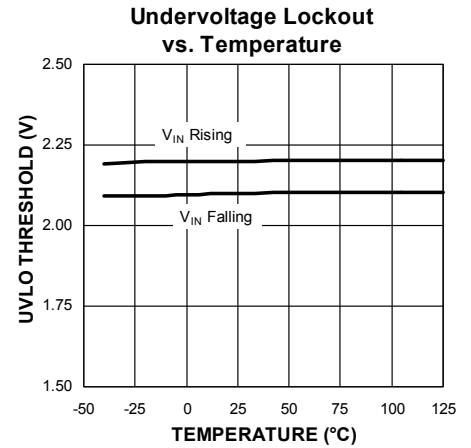
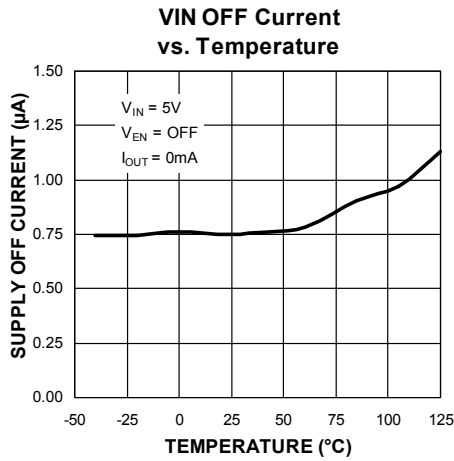
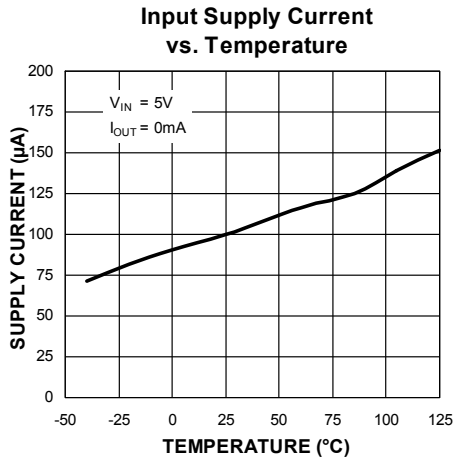
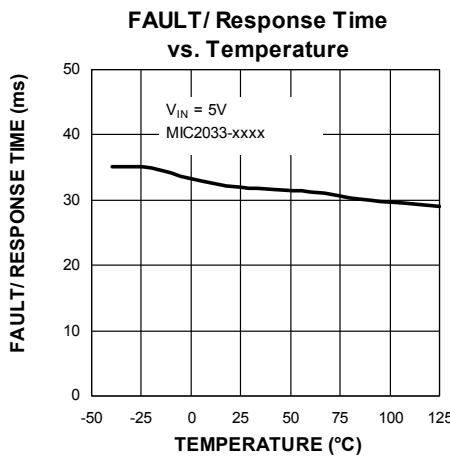
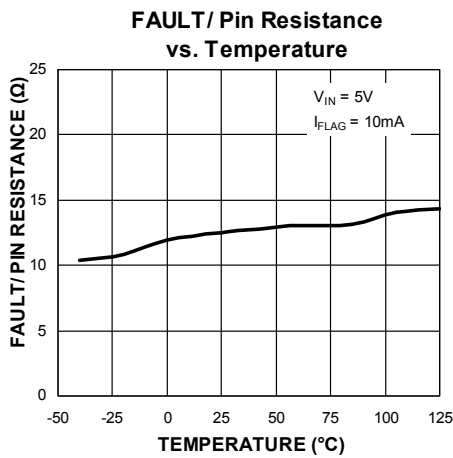
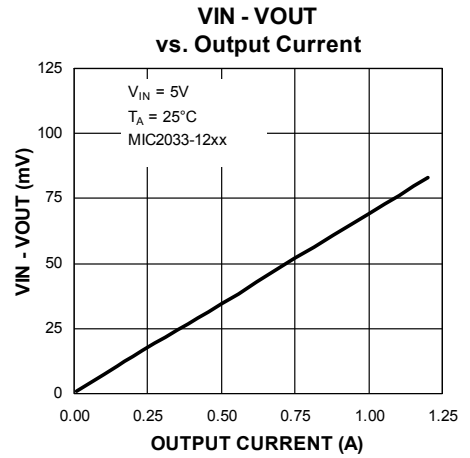
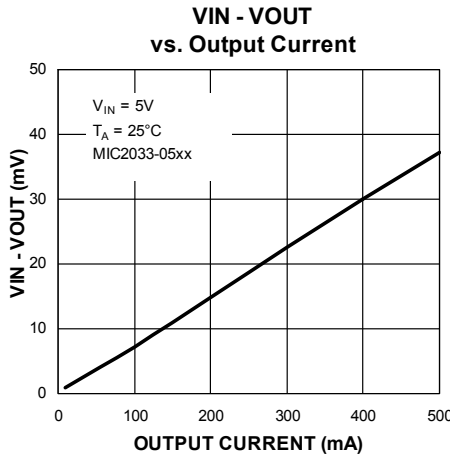
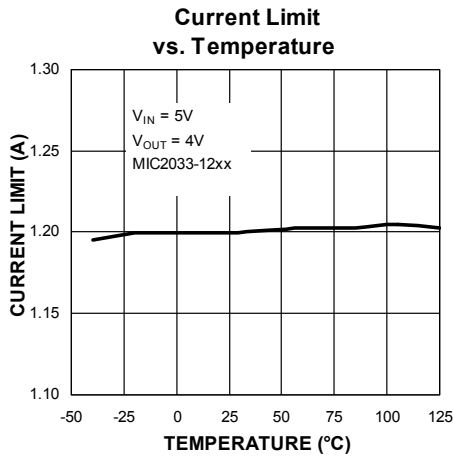
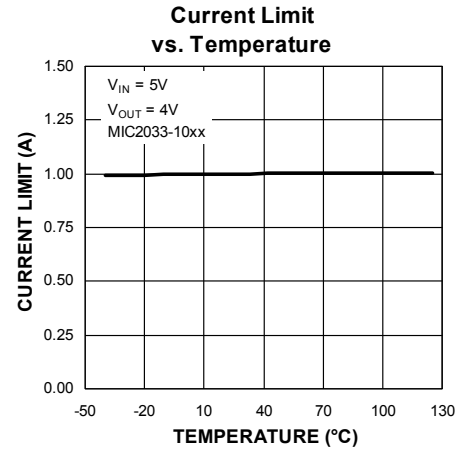
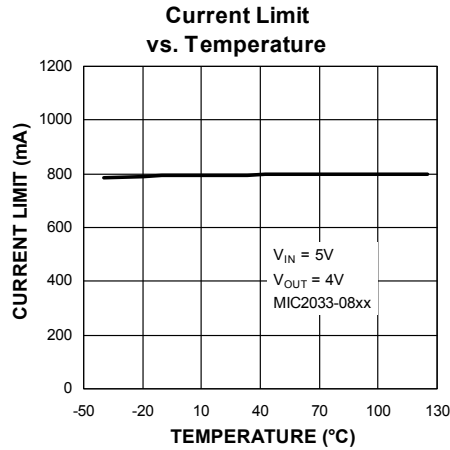
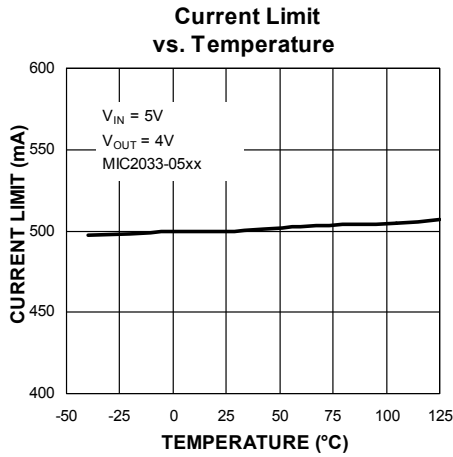

Figure 3. Short Circuit Response Time and Over Current Fault Flag Delay

Typical Characteristics



Typical Characteristics (Continued)



Functional Characteristics

Soft-Start Turn-On

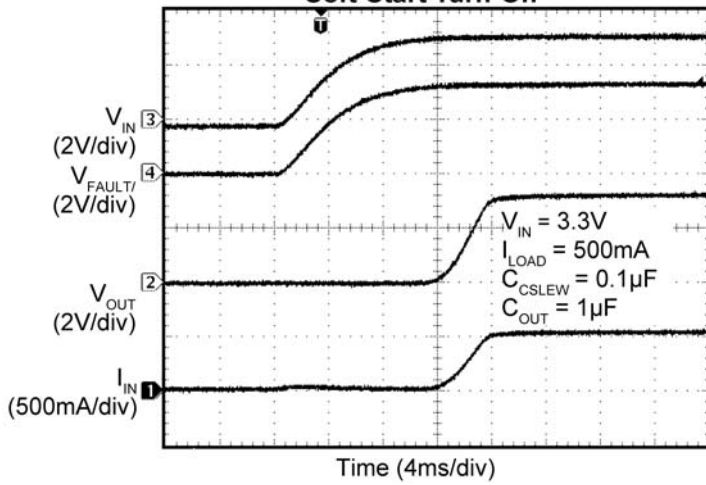

Soft-Start Turn-Off

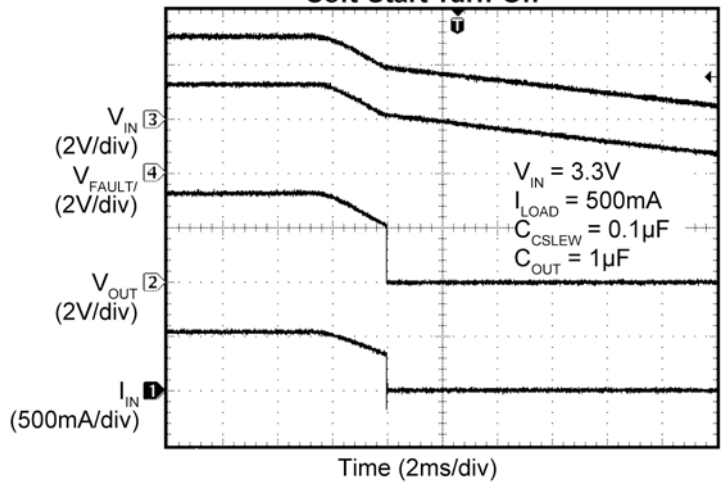

Enable Turn-On

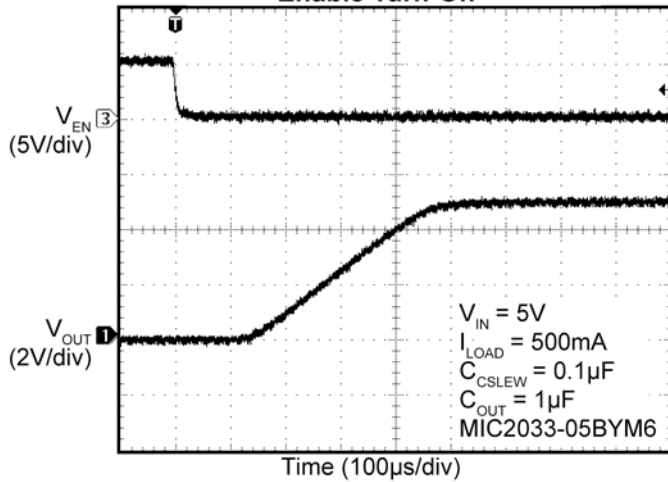

Enable Turn-Off

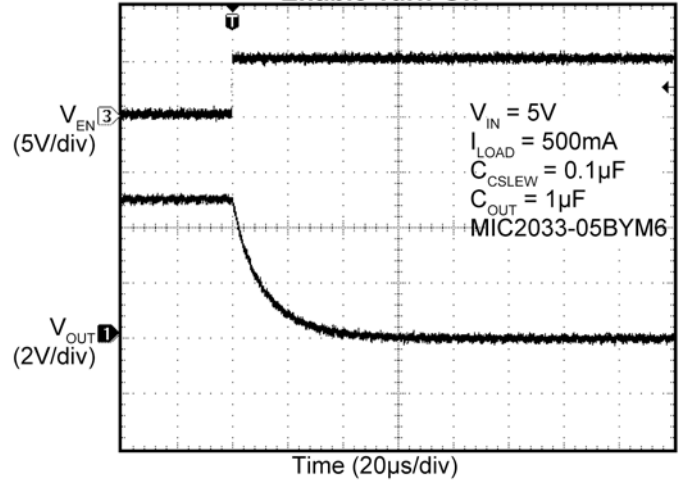

Turn-On Into Short Circuit

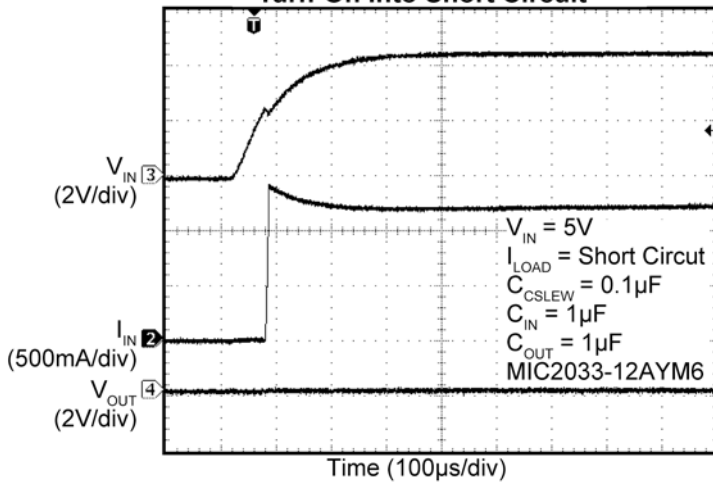

Current Limit Response, 400mA Steady State Load

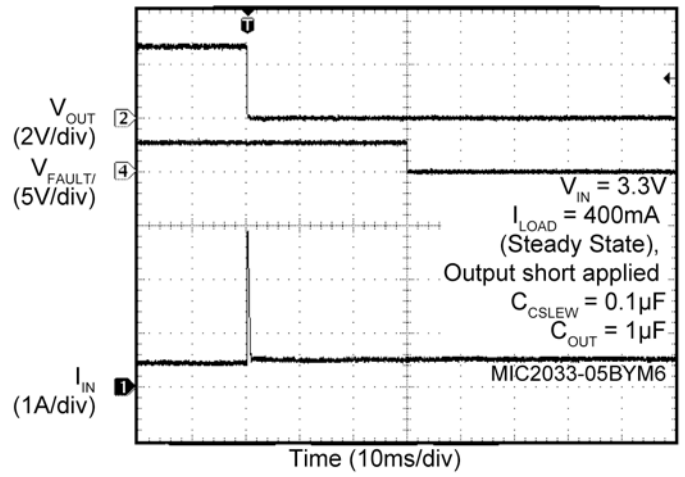

Functional Characteristics (Continued)

Current Limit Response

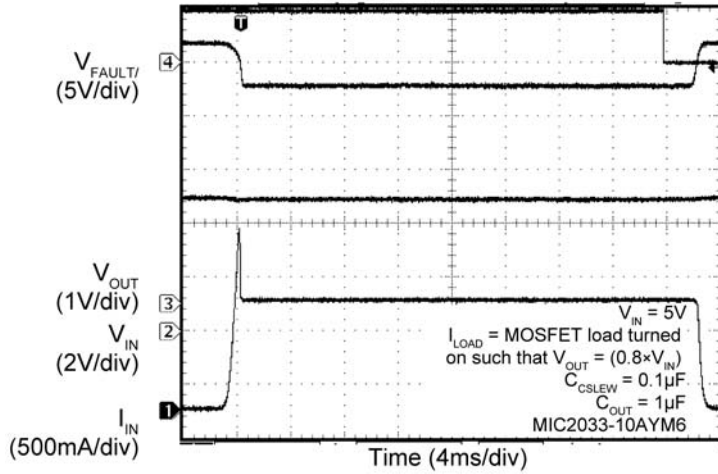

Output Recovery from Short Circuit

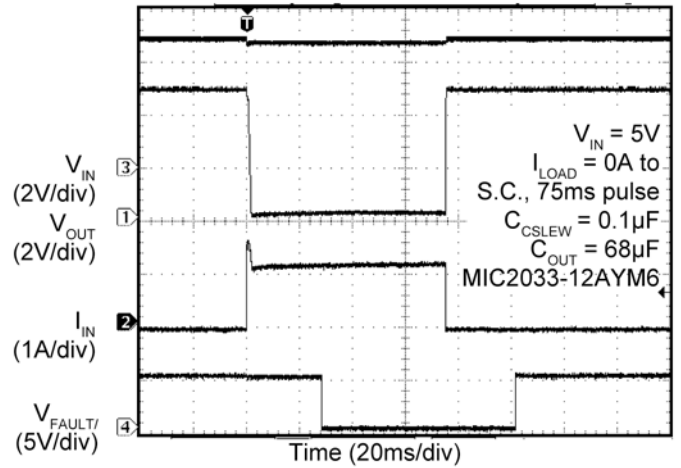

V_{OUT} Recovery from Thermal Shutdown

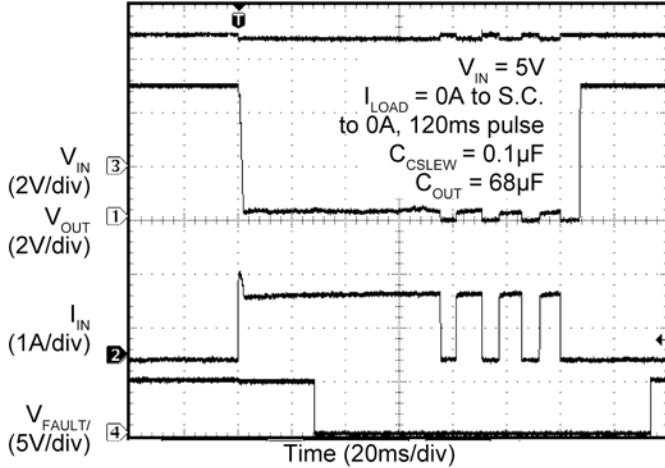

Turn-On Into Minimal Overload

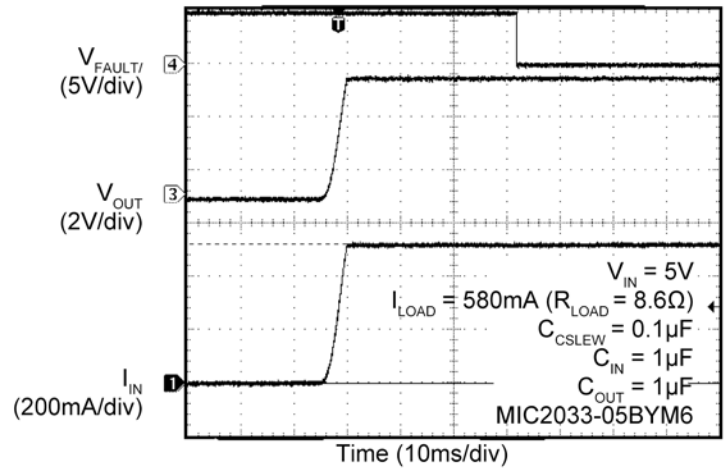

Turn-On Into 50% Overload

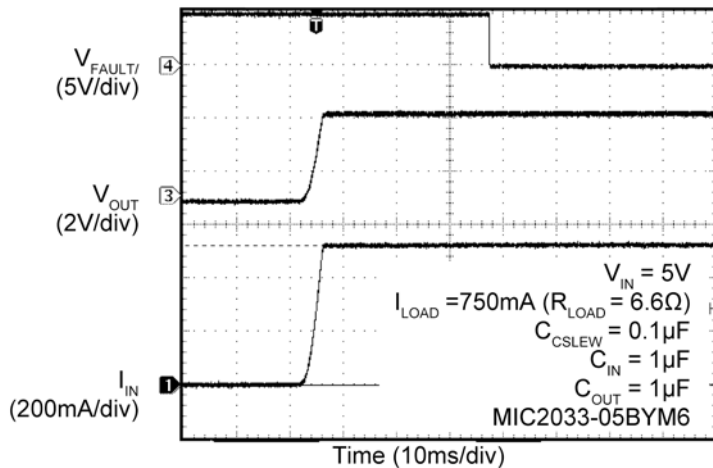

1.5A Overload Response

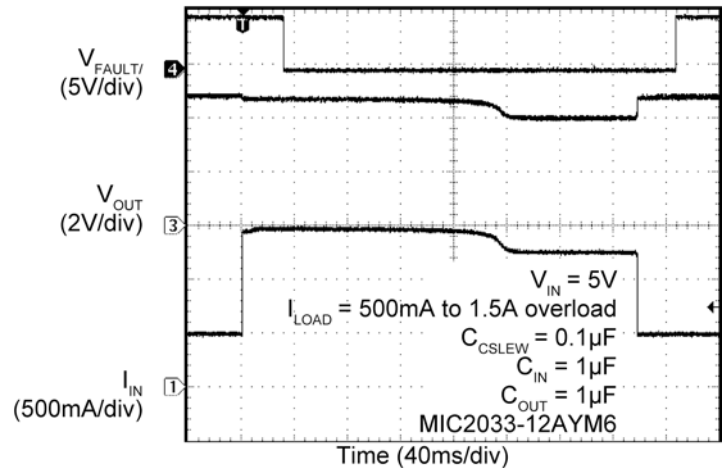

Functional Diagram

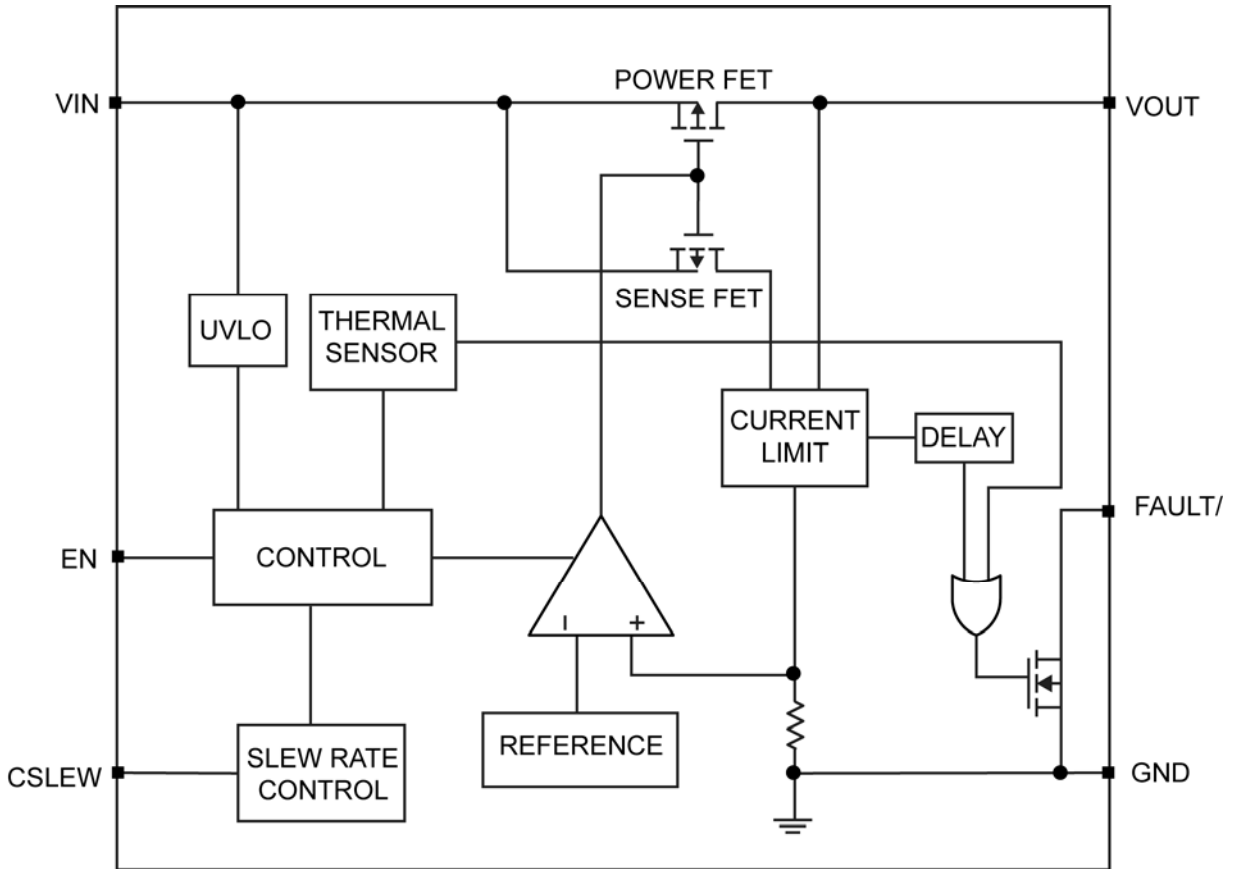

Figure 4. MIC2033 Block Diagram

Functional Description

The MIC2033 is a high-side MOSFET power distribution switch providing increased system reliability utilizing 5% current limit accuracy. The MIC2033 has an operating input voltage range from 2.5V to 5.5V and is internally current limited and has thermal shutdown that protects the device and system.

Soft-Start

Soft-start reduces the power supply input surge current at startup by controlling the output voltage rise time. The input surge appears while the output capacitor is charged up. A slower output rise time will draw a lower input surge current.

During soft-start, an internal current sink discharges the external capacitor at C_{SLEW} to ground to control the ramp of the output voltage. The output voltage rise time is dependent upon the value of C_{SLEW} , the input voltage, output voltage, and the current limit. The value of the C_{SLEW} external capacitor is recommended to be in the range of 0.1 μ F to 1 μ F.

Input Capacitor

A 1 μ F to 10 μ F ceramic input capacitor is recommended for most applications.

The input capacitor must be placed on the same side of the board and next to the MIC2033 to minimize the voltage ringing during transient and short circuit conditions. It is also recommended to use two vias for each end of the capacitor to connect to the power and ground plane.

X7R or X5R dielectric ceramic capacitors are recommended because of their temperature performance. X7R-type capacitors change capacitance by 15% over their operating temperature range and are the most stable type of ceramic capacitors. Z5U and Y5V dielectric capacitors change value by as much as 50% and 60% respectively over their operating temperature ranges. To use a ceramic chip capacitor with Y5V dielectric, the value must be much higher than an X7R ceramic or a tantalum capacitor to ensure the same capacitance value over the operating temperature range.

Output Capacitor

The output capacitor type and placement criteria are the same as the input capacitor. See the *Input Capacitor* section for a detailed description.

Enable

The MIC2033 offers either an active high or active low enable input (EN) that allows ON/OFF control of the switch output. The current through the device reduces to near “zero” when the device is shutdown, with only microamperes of leakage current. The EN input may be

directly tied to V_{IN} or driven by a voltage that is equal to or less than V_{IN} , but do not leave this pin floating.

Current Limit

The MIC2033 is available with four fixed current limit settings: 0.5A, 0.8A, 1A, and 1.2A. If the output current exceeds the set current limit, then the MIC2033 switch will enter constant current limit mode. The maximum allowable current limit may be less than the full specified and/or expected current if the MIC2033 is not mounted on a circuit board with sufficiently low thermal resistance. The MIC2033 responds within 10 μ s to short circuits to limit the output current and also provides an output fault flag that will assert (low) for an over current condition that lasts longer than 32ms.

Thermal Design

To help reduce the thermal resistance, the ePad (underneath the IC) should be soldered to the PCB ground and the placement of thermal vias either underneath or near the ePad is highly recommended. Thermal design requires the following application-specific parameters:

- Maximum ambient temperature (T_A)
- Output current (I_{OUT})
- Input voltage (V_{IN})
- Current Limit (I_{LIMIT})

When the MIC2033 is in constant current limit mode, it may exceed the over temperature threshold. If this occurs, the over temperature condition will shut down the MIC2033 switch and the fault status flag will go active (assert low). After the switch cools down, it will turn on again. The MIC2033 power dissipation can be maximized by either lowering the thermal resistance on the exposed pad (only the DFN package has an exposed pad) on the printed circuit board, or by limiting the maximum allowable ambient temperature.

Thermal Measurements

It is always wise to measure the IC's case temperature to make sure that it is within its operating limits. Although this might seem like a very elementary task, it is very easy to get erroneous results. The most common mistake is to use the standard thermal couple that comes with the thermal voltage meter. This thermal couple wire gauge is large, typically 22 gauge, and behaves like a heatsink, resulting in a lower case measurement.

There are two suggested methods for measuring the IC case temperature: a thermal couple or an infrared thermometer. If a thermal couple is used, it must be constructed of 36 gauge wire or higher to minimize the wire heatsinking effect. In addition, the thermal couple tip must be covered in either thermal grease or thermal glue

to make sure that the thermal couple junction is making good contact to the case of the IC. This thermal couple from Omega (5SC-TT-K-36-36) is adequate for most applications.

To avoid this messy thermal couple grease or glue, an infrared thermometer is recommended. Most infrared

thermometers' spot size is too large for an accurate reading on small form factor ICs. However, an IR thermometer from Optris has a 1mm spot size, which makes it ideal for the 3mm × 3mm DFN package. Also, get the optional stand. The stand makes it easy to hold the beam on the IC for long periods of time.

Evaluation Board Schematic

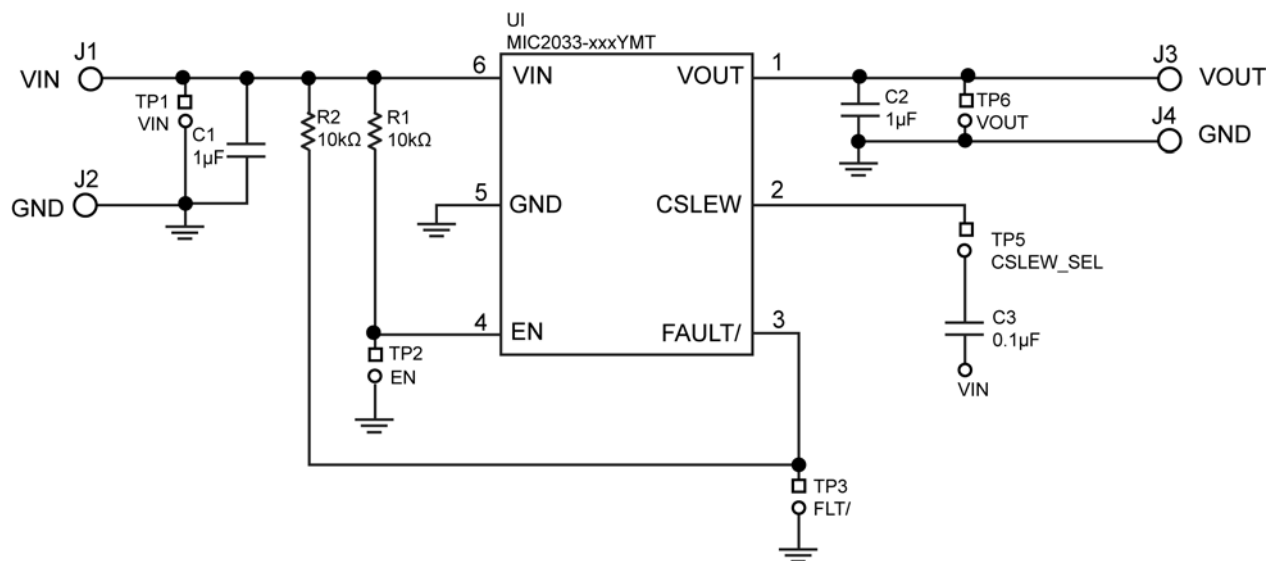

Bill of Materials

Item	Part Number	Manufacturer	Description	Qty.
C1, C2	C1608X5R0J105K	TDK ⁽¹⁾	1µF/6.3V ceramic capacitor, X5R, 0603	2
	06036D105KAT2A	AVX ⁽²⁾		
C3	06033C104KAT2A	TDK	0.1µF/25V ceramic capacitor, X7R, 0603	1
	C1608X7R1E104K	AVX		
R1, R2	CRCW060310K0FKEA	Vishay/Dale ⁽³⁾	10kΩ, film resistor, 0603, 1%	2
U1	MIC2033-xxxYMT	Micrel ⁽⁴⁾	High-accuracy, high-side, fixed current limit power switch	1

Notes:

1. TDK: www.tdk.com.
2. AVX.: www.avx.com.
3. Vishay: www.vishay.com.
4. Micrel, Inc.: www.micrel.com

PCB Layout (MIC2033-xxxYMT Evaluation Board)

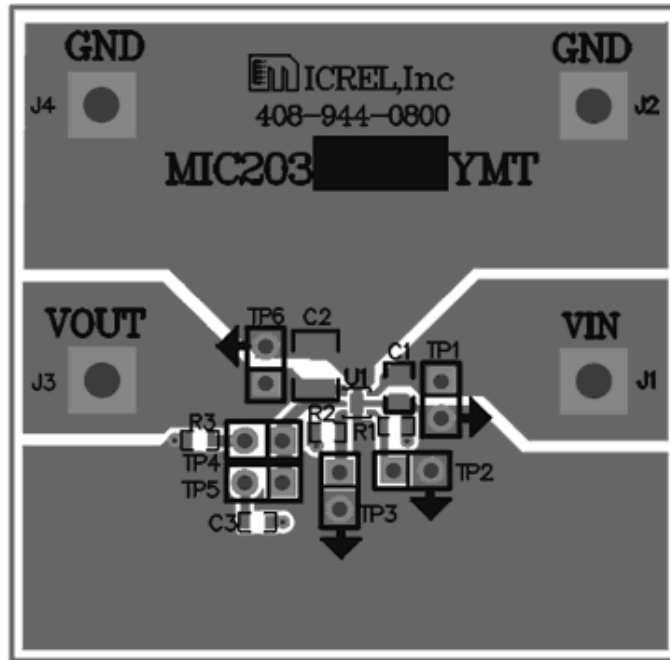

MIC2033-xxxYMT Evaluation Board – Top Layer

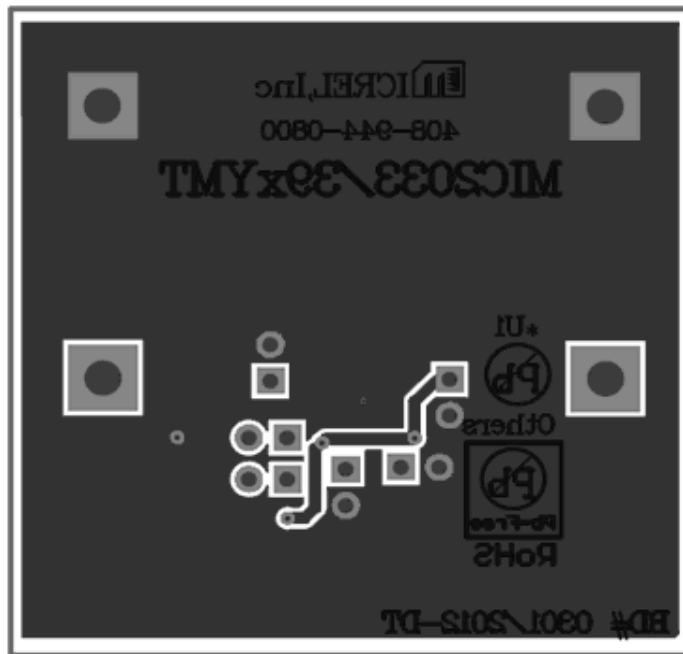

MIC2033-xxxYMT Evaluation Board – Bottom Layer

Package Information

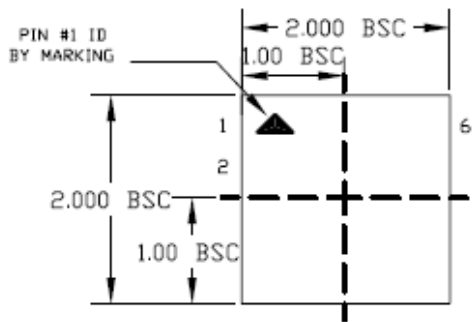

TOP VIEW

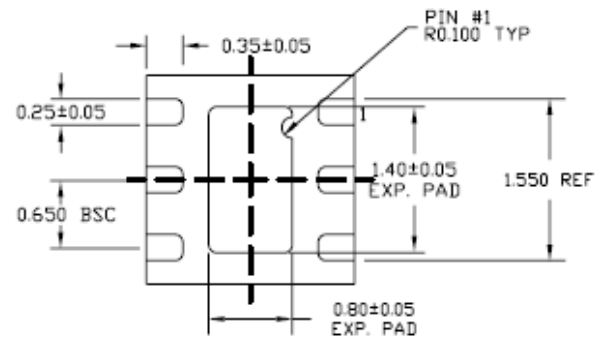

BOTTOM VIEW

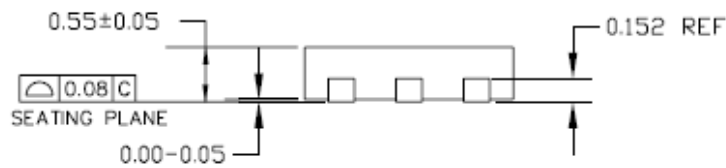

SIDE VIEW

6-Pin 2mm x 2mm Thin DFN (MT)

Package Information (Continued)

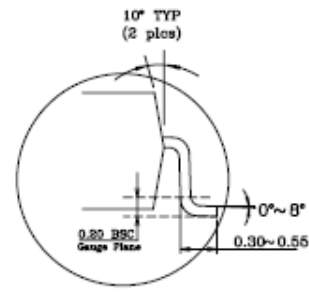
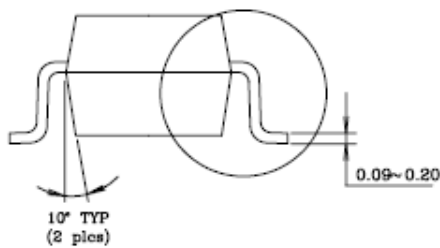
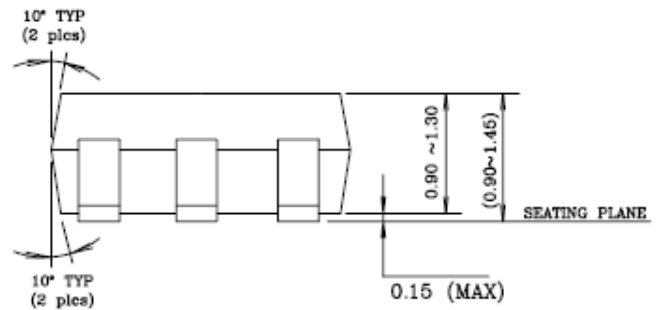
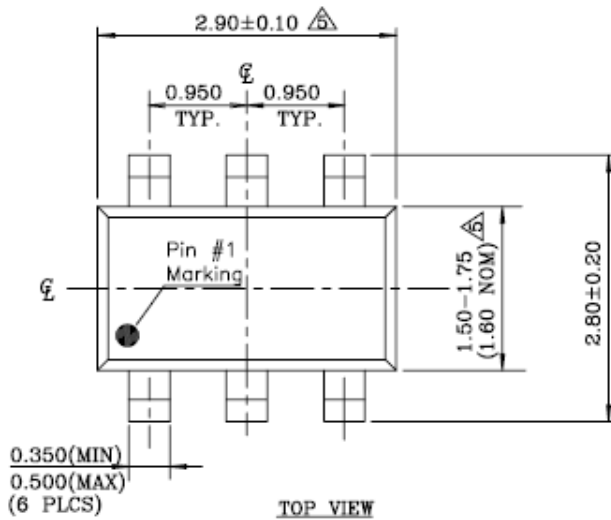

NOTE:

1. Dimensions and tolerances are as per ANSI Y14.5M, 1982.
 2. Package surface to be mirror finish.
 3. Die is facing up for mold. Die is facing down for trim/form, ie. reverse trim/form.
 4. The footlength measuring is based on the gauge plane method.
- Dimension are exclusive of mold flash & gate burr.

SOT23-6L (M6)

MICREL, INC. 2180 FORTUNE DRIVE SAN JOSE, CA 95131 USA
TEL +1 (408) 944-0800 FAX +1 (408) 474-1000 WEB <http://www.micrel.com>

Micrel makes no representations or warranties with respect to the accuracy or completeness of the information furnished in this data sheet. This information is not intended as a warranty and Micrel does not assume responsibility for its use. Micrel reserves the right to change circuitry, specifications and descriptions at any time without notice. No license, whether express, implied, arising by estoppel or otherwise, to any intellectual property rights is granted by this document. Except as provided in Micrel's terms and conditions of sale for such products, Micrel assumes no liability whatsoever, and Micrel disclaims any express or implied warranty relating to the sale and/or use of Micrel products including liability or warranties relating to fitness for a particular purpose, merchantability, or infringement of any patent, copyright or other intellectual property right

Micrel Products are not designed or authorized for use as components in life support appliances, devices or systems where malfunction of a product can reasonably be expected to result in personal injury. Life support devices or systems are devices or systems that (a) are intended for surgical implant into the body or (b) support or sustain life, and whose failure to perform can be reasonably expected to result in a significant injury to the user. A Purchaser's use or sale of Micrel Products for use in life support appliances, devices or systems is a Purchaser's own risk and Purchaser agrees to fully indemnify Micrel for any damages resulting from such use or sale.

© 2012 Micrel, Incorporated.

Mouser Electronics

Authorized Distributor

Click to View Pricing, Inventory, Delivery & Lifecycle Information:

[Micrel:](#)

[MIC2033-55AYMT T5](#) [MIC2033-55AYMT TR](#) [MIC2033-05AYMT T5](#) [MIC2033-10AYM6 T5](#) [MIC2033-08BYM6 T5](#)
[MIC2033-08AYMT T5](#) [MIC2033-10BYM6 T5](#) [MIC2033-08AYM6 T5](#) [MIC2033-08AYM6 TR](#) [MIC2033-10AYMT TR](#)
[MIC2033-05AYMT TR](#) [MIC2033-05AYM6 TR](#) [MIC2033-10AYM6 TR](#) [MIC2033-05BYM6 T5](#) [MIC2033-12AYM6 TR](#)
[MIC2033-10BYMT TR](#)

[Microchip:](#)

[MIC2033-12AYM6-T5](#) [MIC2033-12BYMT-T5](#) [MIC2033-05AYMT-TR](#) [MIC2033-12AYMT-TR](#) [MIC2033-05BYM6-T5](#)
[MIC2033-05BYMT-T5](#) [MIC2033-12AYMT-T5](#) [MIC2033-12BYM6-TR](#) [MIC2033-05BYMT-TR](#) [MIC2033-08BYMT-T5](#)
[MIC2033-10BYM6-T5](#) [MIC2033-55AYM6-TR](#) [MIC2033-05AYMT-T5](#) [MIC2033-08BYM6-TR](#) [MIC2033-08AYMT-TR](#)
[MIC2033-10AYMT-T5](#) [MIC2033-10BYM6-TR](#) [MIC2033-08AYM6-TR](#) [MIC2033-10AYM6-T5](#) [MIC2033-08AYMT-T5](#)
[MIC2033-55AYMT-T5](#) [MIC2033-10BYMT-T5](#) [MIC2033-55AYM6-T5](#) [MIC2033-55AYMT-TR](#) [MIC2033-05AYM6-T5](#)
[MIC2033-12AYM6-TR](#) [MIC2033-05BYM6-TR](#) [MIC2033-10AYM6-TR](#) [MIC2033-05AYM6-TR](#) [MIC2033-12BYMT-TR](#)
[MIC2033-12BYM6-T5](#) [MIC2033-08BYM6-T5](#) [MIC2033-08BYMT-TR](#) [MIC2033-08AYM6-T5](#) [MIC2033-10AYMT-TR](#)
[MIC2033-10BYMT-TR](#)



Стандарт Электрон Связь

Мы молодая и активно развивающаяся компания в области поставок электронных компонентов. Мы поставляем электронные компоненты отечественного и импортного производства напрямую от производителей и с крупнейших складов мира.

Благодаря сотрудничеству с мировыми поставщиками мы осуществляем комплексные и плановые поставки широчайшего спектра электронных компонентов.

Собственная эффективная логистика и склад в обеспечивает надежную поставку продукции в точно указанные сроки по всей России.

Мы осуществляем техническую поддержку нашим клиентам и предпродажную проверку качества продукции. На все поставляемые продукты мы предоставляем гарантию .

Осуществляем поставки продукции под контролем ВП МО РФ на предприятия военно-промышленного комплекса России , а также работаем в рамках 275 ФЗ с открытием отдельных счетов в уполномоченном банке. Система менеджмента качества компании соответствует требованиям ГОСТ ISO 9001.

Минимальные сроки поставки, гибкие цены, неограниченный ассортимент и индивидуальный подход к клиентам являются основой для выстраивания долгосрочного и эффективного сотрудничества с предприятиями радиоэлектронной промышленности, предприятиями ВПК и научно-исследовательскими институтами России.

С нами вы становитесь еще успешнее!

Наши контакты:

Телефон: +7 812 627 14 35

Электронная почта: sales@st-electron.ru

Адрес: 198099, Санкт-Петербург,
Промышленная ул, дом № 19, литера Н,
помещение 100-Н Офис 331