

EVALUATION KIT
AVAILABLE

Remote Antenna, Current-Sense and LDO/Switches

General Description

The MAX16946/MAX16947 high-voltage, high-side, current-sense LDO/switches feature internal current limiting to prevent system damage due to fault conditions. The MAX16946 provides a fixed regulated 8.5V output voltage or an adjustable 3.3V to 15V output voltage. The MAX16946 can also be configured as a switch, while the MAX16947 is only available as a switch. The input voltage range for both devices extends from 4.5V to 18V (45V tolerant), making the devices ideal for providing phantom power to remote radio-frequency low-noise amplifiers (LNAs) in automotive applications.

The devices monitor the load current and provide an analog output voltage proportional to the sensed load current. Accurate internal current limit protects the input supply against both overload and short-circuit conditions. Two open-drain fault indicator outputs indicate to the microprocessor when a short circuit, an open-load condition, or a short-to-battery condition exists. An over-temperature shutdown is also indicated by means of the current-sense amplifier's output voltage.

A fault-blanking feature allows the devices to ignore momentary faults such as those caused by the charging of capacitive loads during hot-swapping, preventing false alarms to the system. The devices feature short-to-battery protection to latch off the internal LDO/pass switch during a short-to-battery event. During a thermal overload, the devices reduce power dissipation by going into thermal shutdown. They include an active-low, high-voltage-compatible shutdown input to place them in low-power shutdown mode.

The MAX16946 is available in thermally enhanced, 16-pin TQFN-EP and QSOP-EP packages. The MAX16947 is available in a 16-pin QSOP package. Both devices operate over the -40°C to $+105^{\circ}\text{C}$ temperature range.

Ordering Information

PART	PIN-PACKAGE	OUTPUT
MAX16946GEE/V+**	16 QSOP-EP*	Switch or LDO
MAX16946GTE/V+	16 TQFN-EP*	Switch or LDO
MAX16947GEE/V+**	16 QSOP	Switch

Note: All devices are specified over the -40°C to $+105^{\circ}\text{C}$ operating temperature range.

/V Denotes an automotive qualified part.

+ Denotes a lead(Pb)-free/RoHS-compliant package.

*EP = Exposed pad.

**Future product—contact factory for availability.

Features

- ◆ Switch Phantom Power-On/Off Under μC Control
- ◆ Precision Adjustable Current Limit
300mA (max), $T_A = +105^{\circ}\text{C}$
500mA (max), $T_A = +85^{\circ}\text{C}$ (MAX16946 in SW Mode Only)
- ◆ Regulated Output Voltage (MAX16946)—8.5V
Fixed or Adjustable Between 3.3V and 15V
- ◆ Current Measurement Analog Voltage Output
- ◆ Detect Open-Load and Short-Circuit Conditions
- ◆ Provide Open-Drain Fault Signals ($\overline{\text{SC}}$ and $\overline{\text{OL}}$)
- ◆ Overcurrent Blanking During Startup
- ◆ Thermal Shutdown
- ◆ AEC-Q100 Qualified
- ◆ -40°C to $+105^{\circ}\text{C}$ Operating Temperature Range

Applications

Remote LNA Phantom Power
Automotive Safety and Infotainment
Automotive Remote Module Power

Functional Diagram

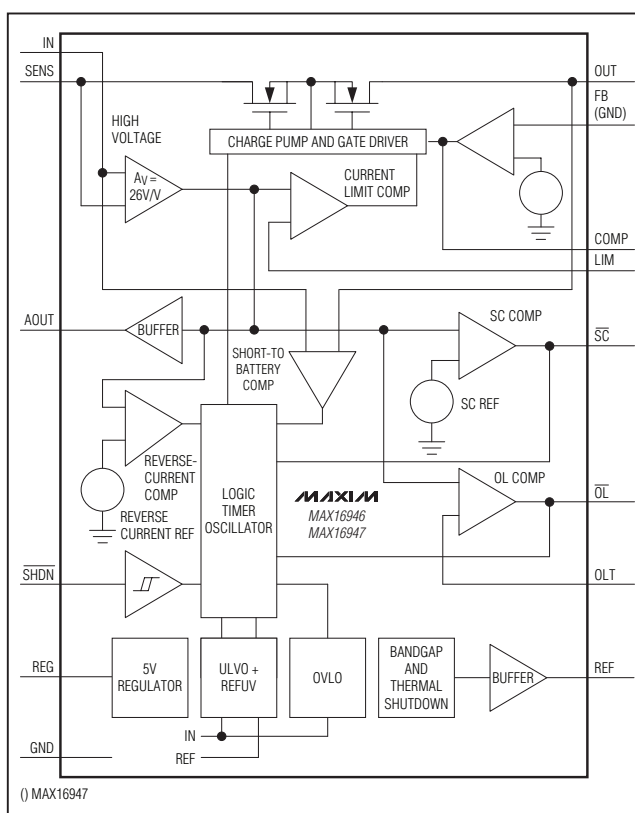

Remote Antenna, Current-Sense and LDO/Switches

ABSOLUTE MAXIMUM RATINGS

\overline{SC} , \overline{OL} , REG to GND	-0.3V to +6.0V
OLT, LIM, FB, AOUT, REF, COMP to GND	-0.3V to (V _{REG} + 0.3V)
IN, SENS, \overline{SHDN} to GND	-0.3V to +28V
IN, SENS, \overline{SHDN} to GND (< 1s).....	-0.3V to +45V
OUT to GND	-0.3V to +20V
IN to SENS.....	-0.3V to +0.3V
Continuous Power Dissipation (T _A = +70°C)	
QSOP (derate 9.5mW/°C above +70°C)	761mW
QSOP-EP (derate 22.7mW/°C above +70°C).....	1818mW
TQFN-EP (derate 25mW/°C above +70°C)	2000mW

Junction-to-Ambient Thermal Resistance (θ _{JA}) (Note 1)	
QSOP	105°C/W
QSOP-EP	44°C/W
TQFN-EP	40°C/W
Junction-to-Case Thermal Resistance (θ _{JC}) (Note 1)	
QSOP	37°C/W
QSOP-EP	6°C/W
TQFN-EP	6°C/W
Operating Temperature Range	-40°C to +105°C
Junction Temperature	-40°C to +150°C
Storage Temperature Range.....	-65°C to +150°C
Lead Temperature (soldering, 10s)	+300°C
Soldering Temperature (reflow)	+260°C

Note 1: Package thermal resistances were obtained using the method described in JEDEC specification JESD51-7, using a four-layer board. For detailed information on package thermal considerations, refer to www.maxim-ic.com/thermal-tutorial.

Stresses beyond those listed under "Absolute Maximum Ratings" may cause permanent damage to the device. These are stress ratings only, and functional operation of the device at these or any other conditions beyond those indicated in the operational sections of the specifications is not implied. Exposure to absolute maximum rating conditions for extended periods may affect device reliability.

ELECTRICAL CHARACTERISTICS

(V_{IN} = 12V, V_{GND} = 0V, T_A = -40°C to +105°C, unless otherwise noted. Typical values are at T_A = T_J = +25°C.)

PARAMETER	SYMBOL	CONDITIONS		MIN	TYP	MAX	UNITS
POWER SWITCH/LDO							
IN Operating Supply Range	V _{IN}	Full performance		4.5		18	V
		Output switched off (Note 2)				28	V
		Output switched off for < 1s (Note 2)				45	V
IN Supply Current	I _{CC}	V _{SHDN} > 2.4V, T _A = +25°C			2.1	2.6	mA
IN Shutdown Supply Current	I _{SD}	V _{SHDN} = V _{GND} , T _A = +25°C, V _{IN} = 12V				7	µA
Undervoltage Lockout (Rising)	V _{UVLO}	Falling V _{IN}			3.5		V
		Rising V _{IN}			3.9		
		Hysteresis			0.4		
Internal Switch Voltage Drop	V _{SW}	Measured between SENS and OUT while sourcing 100mA, FB grounded, SW operation, T _A = +25°C, 4.5V < V _{IN} < 18V				0.20	V
		Measured between SENS and OUT while sourcing 100mA, FB grounded, SW operation, T _A = +105°C, 4.5V < V _{IN} < 18V (Note 2)			0.2	0.25	V
Internal Voltage Regulator	V _{REG}	I _{REG} = 0mA, T _A = +25°C			5		V
Feedback Voltage	V _{FB}	MAX16946 only, LDO mode with FB connected to external resistive divider	I _{OUT} = 5mA to 150mA, 4.5V ≤ V _{IN} ≤ 18V	0.97	1	1.03	V
			I _{OUT} = 2mA to 200mA, 4.5V < V _{IN} ≤ 18V	0.95	1	1.05	V

Remote Antenna, Current-Sense and LDO/Switches

MAX16946/MAX16947

ELECTRICAL CHARACTERISTICS (continued)

($V_{IN} = 12V$, $V_{GND} = 0V$, $T_A = -40^{\circ}C$ to $+105^{\circ}C$, unless otherwise noted. Typical values are at $T_A = T_J = +25^{\circ}C$.)

PARAMETER	SYMBOL	CONDITIONS	MIN	TYP	MAX	UNITS
Feedback Input Bias Current	I _{FB}	V _{FB} = 1.0V, LDO mode, T _A = +25°C	-0.5		+0.5	μA
		V _{FB} = 1.0V, LDO mode, T _A = +105°C		0		
Fixed 8.5V to LDO Mode Feedback Threshold	V _{FB_TH}	Switching to LDO mode from fixed 8.5V	3.3		4.2	V
Adjustable Output Voltage Range	V _{OUT}	LDO mode with external resistive divider, V _{IN} > V _{OUT} + V _{DROPOUT} (Note 3)	3.3		15	V
FB Load Regulation		V _{IN} - V _{OUT} ≥ 2V, I _{OUT} = 5mA to 100mA, LDO mode		-2		%
FB Line Regulation		V _{IN} - V _{OUT} ≥ 2V, I _{OUT} = 6mA, LDO mode		20		mV/V
Fixed 8.5V Output Voltage	V _{OUT_8.5V}	I _{OUT} = 5mA, LDO mode with internal resistive divider, 9V ≤ V _{IN} ≤ 18V	8.33	8.5	8.67	V
Power-Supply Rejection Ratio	PSRR	V _{IN} - V _{OUT} ≥ 2V, f = 100Hz, LDO mode		50		dB
Startup Response Time	t _{ST}	\overline{SHDN} rising to switch/LDO on, time needed to charge C _{COMP} = 0.1μF		10		ms
OUT Pulldown Resistor Value	R _{OUT_OFF}	V \overline{SHDN} = V _{GND} , T _A = +25°C			250	kΩ
COMP Power-Down Resistor Value	R _{COMP_OFF}	V \overline{SHDN} = V _{GND} , T _A = +25°C			120	kΩ
CURRENT-SENSE AMPLIFIER						
AOUT Gain	A _V	V _{AOUT} /(V _{IN} - V _{SENS}), measured with V _{IN} - V _{SENS} = 20mV and 100mV, 4.5V < V _{IN} < 18V	25.35	26	26.65	V/V
Current-Sense Amplifier Input Voltage Range	V _{INR}	Drop across the shunt resistor, normal operation	0		125	mV
AOUT Zero-Current Output Voltage	V _{AOUT_ZS}	(V _{IN} - V _{SENS}) = 0V, 4.5V < V _{IN} < 18V	0.368	0.4	0.432	V
Maximum AOUT Voltage	V _{AOUT_FS}	(V _{IN} - V _{SENS}) = 125mV, if V _{LIM} = V _{REF} then V _{AOUT(MAX)} = 3V		3.65		V
AOUT Drive Capability	I _{AOUT}	(V _{IN} - V _{SENS}) = 30mV	1.0			mA
AOUT Leakage Current	I _{AOUT_LEAK}	V \overline{SHDN} = V _{GND} , T _A = +25°C	2			μA
SENS Leakage Current	I _{SENS_LEAK}	V \overline{SHDN} = V _{GND} , T _A = +25°C			2	μA
REFERENCE						
REF Output Voltage	V _{REF}	4.5V < V _{IN} < 18V	2.94	3	3.06	V
REF Undervoltage	V _{REF_UV}	V _{REF} falling	2.18		2.72	V
REF Output Current	I _{REF}		100			μA
REF Leakage Current	I _{REF_LEAK}	V \overline{SHDN} = V _{GND} , T _A = +25°C			2	μA
FAILURE DETECTION COMPARATORS						
Open-Load Comparator Input Common-Mode Range	V _{VOLT_CMR}	(Note 2)	0.4		1.7	V
Open-Load Comparator Offset Voltage	V _{VOLT_OS}	V _{VOLT} = 1.05V	-40	0	+40	mV

Remote Antenna, Current-Sense and LDO/Switches

ELECTRICAL CHARACTERISTICS (continued)

($V_{IN} = 12V$, $V_{GND} = 0V$, $T_A = -40^{\circ}C$ to $+105^{\circ}C$, unless otherwise noted. Typical values are at $T_A = T_J = +25^{\circ}C$.)

PARAMETER	SYMBOL	CONDITIONS	MIN	TYP	MAX	UNITS
OLT Input Bias Current	I_{OLT}	$V_{OLT} = 1.05V$, $T_A = +25^{\circ}C$	-0.5		+0.5	μA
		$V_{OLT} = 1.05V$, $T_A = +105^{\circ}C$		0		
Initial Open-Load Blanking Time	t_{OL}	A switched open load is blanked for t_{OL}	100			ms
Open-Load Glitch Immunity	t_{OL_GLITCH}	$I_{OUT} < I_{OL}$	10		100	μs
Current-Limit Comparator Input Common-Mode Range	V_{LIM_CMR}	If V_{LIM} is derived from REF then maximum voltage at LIM is 3V (Note 2)	1.7		3.65	V
Current-Limit Comparator Input Offset Voltage	V_{LIM_OS}	$V_{LIM} = 2.675V$	-80	0	+80	mV
LIM Input Bias Current	I_{LIM_BIAS}	$V_{LIM} = 2.675V$, $T_A = +25^{\circ}C$	-0.5		+0.5	μA
		$V_{LIM} = 2.675V$, $T_A = +105^{\circ}C$		0		
Short-Circuit AOUT Voltage Threshold	V_{SC}	Rising V_{AOUT} at which the \overline{SC} output asserts low, hysteresis of 40mV, $4.5V < V_{IN} < 18V$	1.65	1.7	1.75	V
Short-Circuit Current Blanking Time	t_{BLANK}	$I_{OUT} > I_{SC}$	100			ms
Delay Time Before Retry After Short-Circuit Current Turn-Off	t_{RETRY}	$I_{OUT} > I_{SC}$	1100			ms
IN Overvoltage Lockout Threshold	V_{OVLO}	V_{IN} rising, hysteresis = 0.5V (typ)	19	21	23	V
Short-to-BAT Threshold in Off-State	V_{OUT_BAT}	Short to battery detected when $V_{IN} - V_{OUT} < V_{OUT_BAT}$	0	250	500	mV
Reverse-Current Detection Level	V_{REV}	Power switch on (SW or LDO mode), $V_{REV} = V_{IN} - V_{SENS}$, $V_{REV} = -9.6mV$ produces $V_{AOUT} = 150mV$, $V_{REV} = -5.7mV$ produces $V_{AOUT} = 250mV$	-9.6		-5.7	mV
Reverse-Current Shutdown Time	t_{SD_REV}	Delay to shut down switch or LDO after V_{REV} exceeds -7.7mV (typ), $T_A = +25^{\circ}C$			5	μs
Feedback Voltage Out of Range	V_{FB_ERR}	LDO mode	1.12		1.28	V
Reverse-Current Blanking Time for Short-Circuit Events	t_{REV_BLANK}	Switching on and off into a temporary load (short-circuit events)		16		ms
OVERTEMPERATURE PROTECTION						
Thermal Shutdown Threshold	T_{SHDN}			+170		$^{\circ}C$
Thermal Shutdown Hysteresis	T_{HYST}			15		$^{\circ}C$
LOGIC						
\overline{SC} , \overline{OL} Output-Voltage Low	V_{OL}	Sinking current = 1mA			0.4	V
\overline{SC} , \overline{OL} Open-Drain Leakage Current	I_{SC_LEAK} , I_{OL_LEAK}	\overline{SC} , \overline{OL} not asserted, $V_{\overline{SC}} = V_{\overline{OL}} = 5V$, $T_A = +25^{\circ}C$			1	μA

Remote Antenna, Current-Sense and LDO/Switches

MAX16946/MAX16947

ELECTRICAL CHARACTERISTICS (continued)

($V_{IN} = 12V$, $V_{GND} = 0V$, $T_A = -40^{\circ}C$ to $+105^{\circ}C$, unless otherwise noted. Typical values are at $T_A = T_J = +25^{\circ}C$.)

PARAMETER	SYMBOL	CONDITIONS	MIN	TYP	MAX	UNITS
SHDN Input-Voltage High	V_{SHDN_HI}		2.7			V
SHDN Input-Voltage Low	V_{SHDN_LO}				0.8	V
SHDN Input Current	I_{SHDN}	$V_{SHDN} > 6V$		5		μA
SHDN Off-Time	t_{SHDN_OFF}		150	256	420	μs

Note 2: Guaranteed by design and not production tested.

Note 3: $V_{DROPOUT}$ is voltage from V_{IN} to V_{OUT} and includes drop across the sense resistor and internal power FET. Additionally, $V_{OUT} + V_{DROPOUT} < V_{OVLO(MIN)} = 19V$.

Typical Operating Characteristics

($V_{IN} = 14V$, $R_{SENSE} = 0.5\Omega$, $T_A = +25^{\circ}C$, unless otherwise noted.)

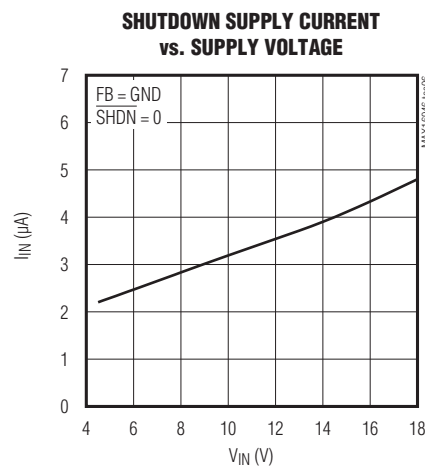
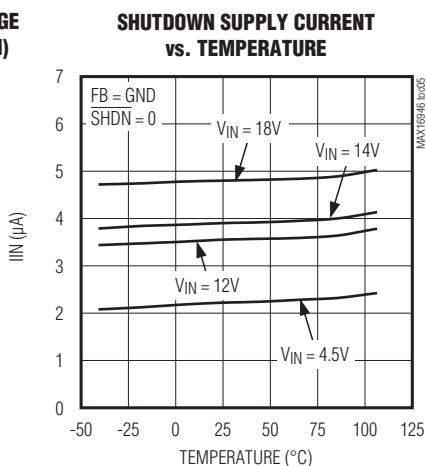
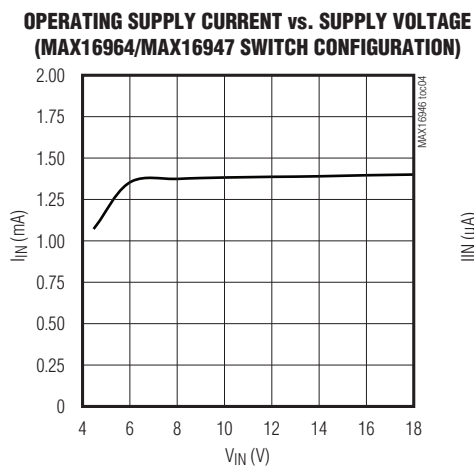
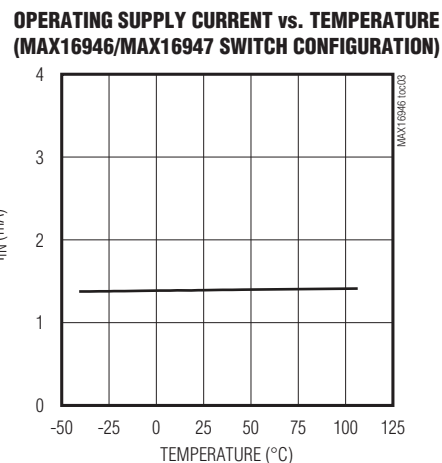
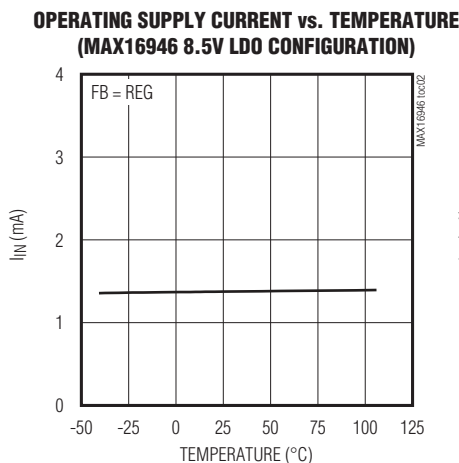
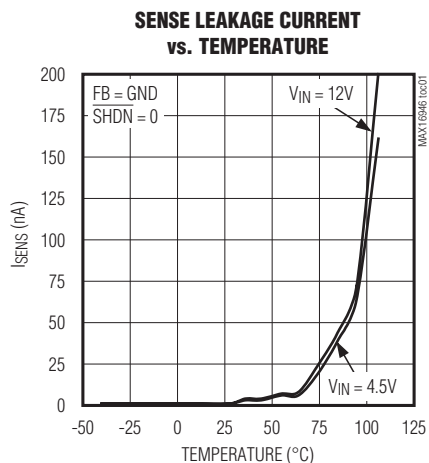

Remote Antenna, Current-Sense and LDO/Switches

Typical Operating Characteristics (continued)

($V_{IN} = 14V$, $R_{SENSE} = 0.5\Omega$, $T_A = +25^\circ C$, unless otherwise noted.)

DROPOUT VOLTAGE vs. LOAD CURRENT (SWITCHED OUTPUT)

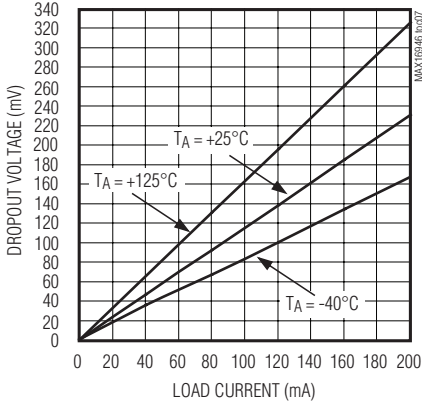

DROPOUT VOLTAGE vs. LOAD CURRENT (OUTPUT = 5V)

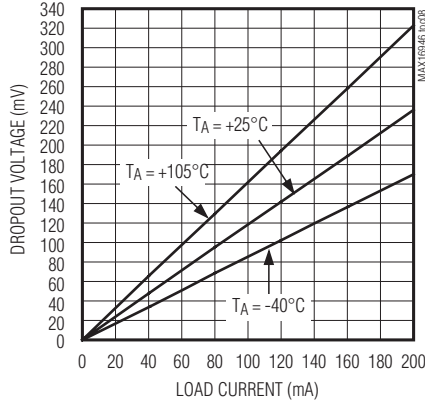

DROPOUT VOLTAGE vs. LOAD CURRENT (OUTPUT = 8.5V)

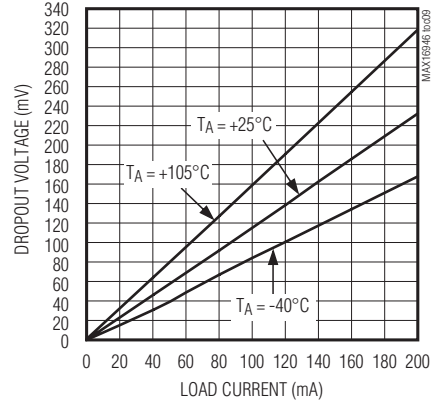

DROPOUT VOLTAGE vs. SUPPLY VOLTAGE (SWITCHED OUTPUT)

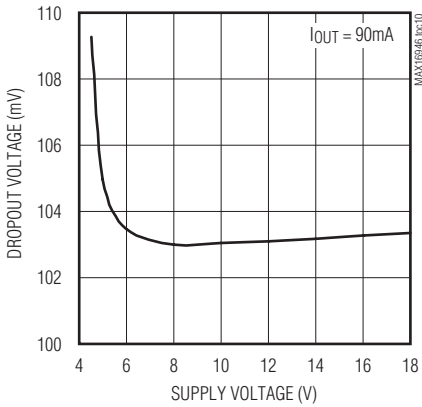

OUTPUT VOLTAGE vs. TEMPERATURE

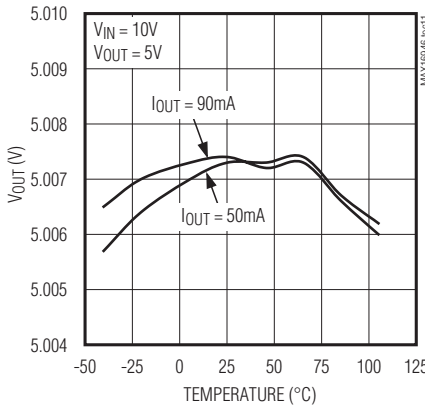

OUTPUT VOLTAGE vs. TEMPERATURE (MAX16946 8.5V LDO CONFIGURATION)

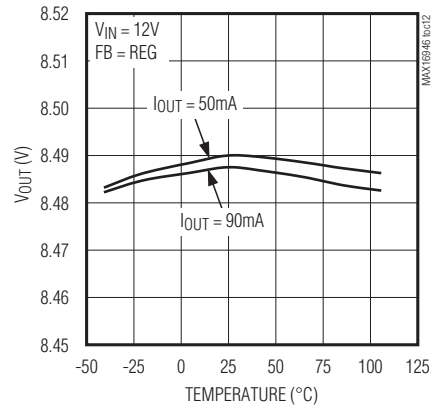

REF OUTPUT VOLTAGE vs. TEMPERATURE

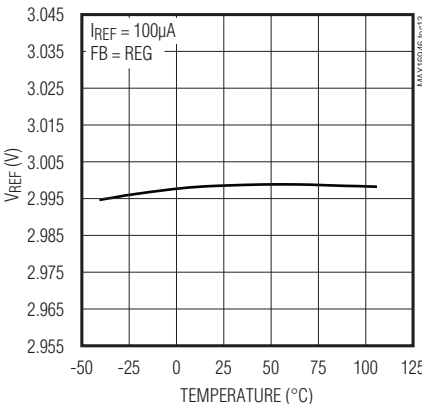

POWER-SUPPLY REJECTION RATIO vs. FREQUENCY

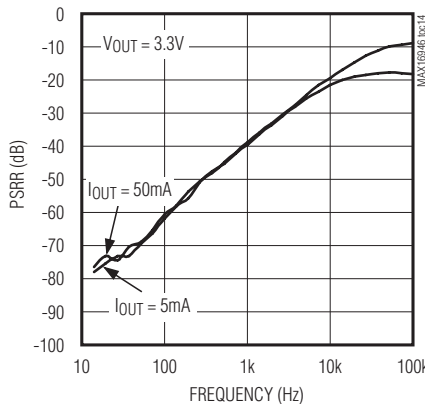

POWER-SUPPLY REJECTION RATIO vs. FREQUENCY

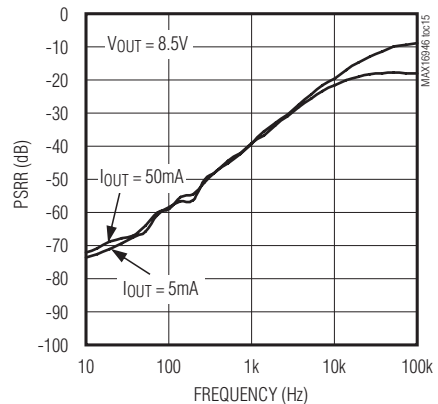

Remote Antenna, Current-Sense and LDO/Switches

Typical Operating Characteristics (continued)

($V_{IN} = 14V$, $R_{SENSE} = 0.5\Omega$, $T_A = +25^\circ C$, unless otherwise noted.)

MAX16946/MAX16947

**LOAD TRANSIENT RESPONSE
(5V LDO MODE)**

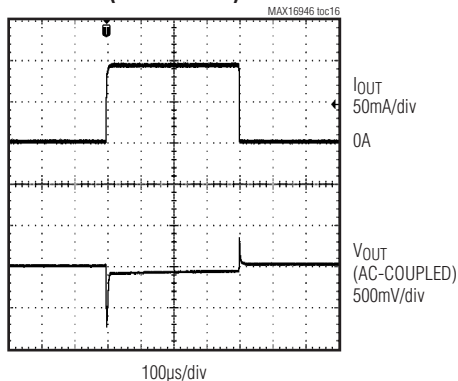

**LINE TRANSIENT RESPONSE
(5V LDO MODE)**

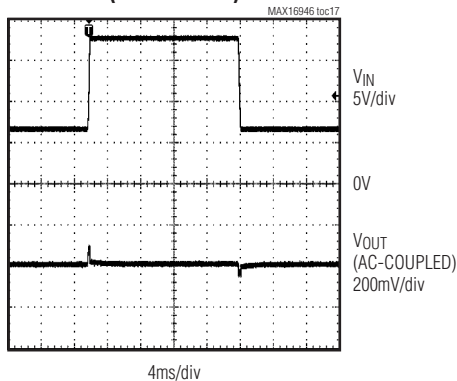

**POWER-UP WAVEFORMS
($V_{OUT} = 8.5V$, $I_{OUT} = 90mA$)**

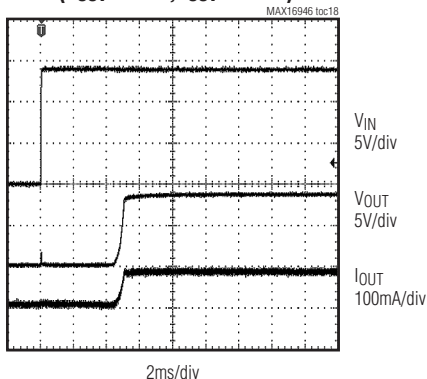

**POWER-UP WAVEFORMS
(SW MODE, $I_{OUT} = 90mA$)**

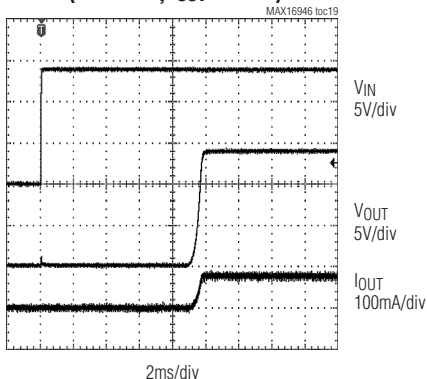

**STARTUP WAVEFORMS
($V_{OUT} = 8.5V$, $I_{OUT} = 90mA$)**

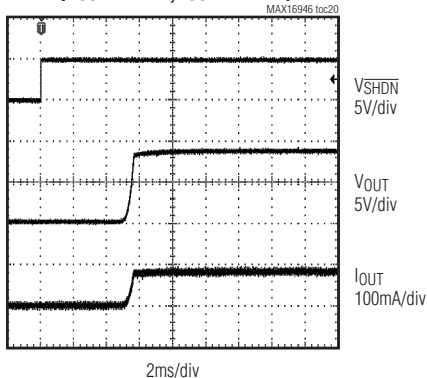

**STARTUP WAVEFORMS
(SW MODE, $I_{OUT} = 90mA$)**

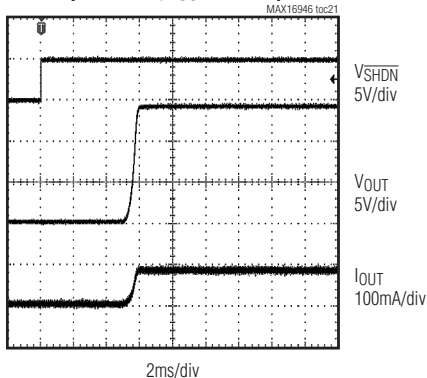

Remote Antenna, Current-Sense and LDO/Switches

Typical Operating Characteristics (continued)

($V_{IN} = 14V$, $R_{SENSE} = 0.5\Omega$, $T_A = +25^\circ C$, unless otherwise noted.)

HIGH-VOLTAGE LINE TRANSIENT RESPONSE (MAX16947)

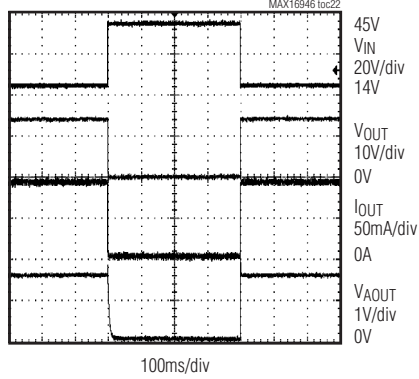

AOUT GAIN vs. TEMPERATURE

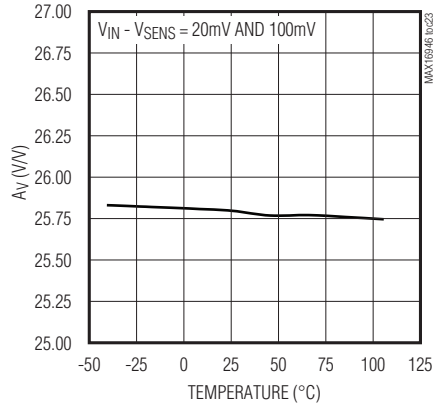

CURRENT-SENSE AMPLIFIER GAIN vs. TEMPERATURE

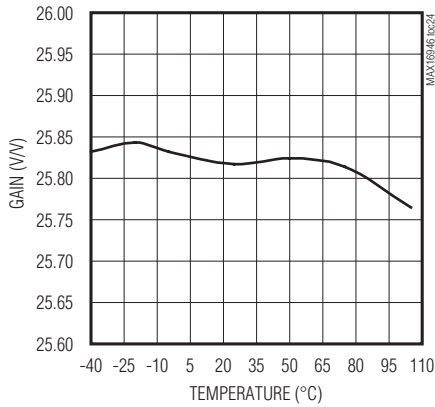

OVERCURRENT BLANKING TIME vs. TEMPERATURE

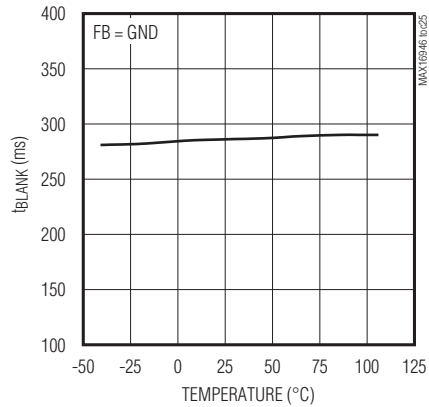

OVERCURRENT BLANKING TIME vs. SUPPLY VOLTAGE

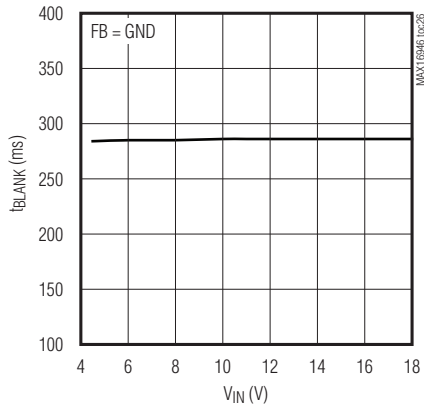

DROPOUT VOLTAGE (V_{SENS} - V_{OUT}) vs. TEMPERATURE (MAX16946 SWITCH CONFIGURATION)

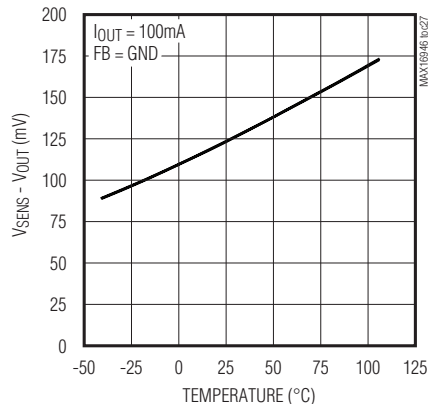

Remote Antenna, Current-Sense and LDO/Switches

Typical Operating Characteristics (continued)

($V_{IN} = 14V$, $R_{SENSE} = 0.5\Omega$, $T_A = +25^\circ C$, unless otherwise noted.)

**DROPOUT VOLTAGE ($V_{SENS} - V_{OUT}$) vs. TEMPERATURE
(MAX16946 8.5V LDO CONFIGURATION)**

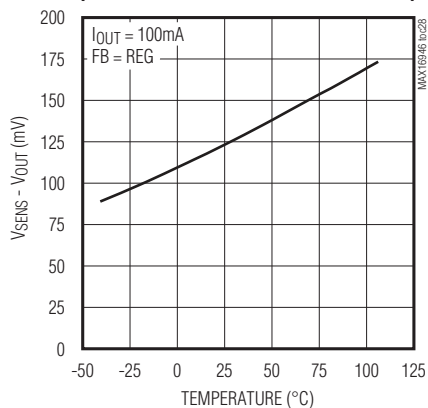

**OPEN-LOAD FAULT
($V_{OUT} = 8.5V$, $I_{OUT} = 50mA$)**

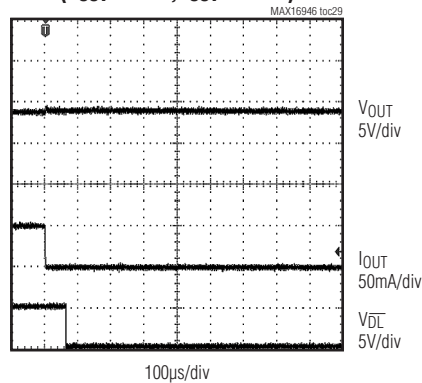

**CLEARING OPEN-LOAD FAULT
($V_{OUT} = 8.5V$, $I_{OUT} = 50mA$)**

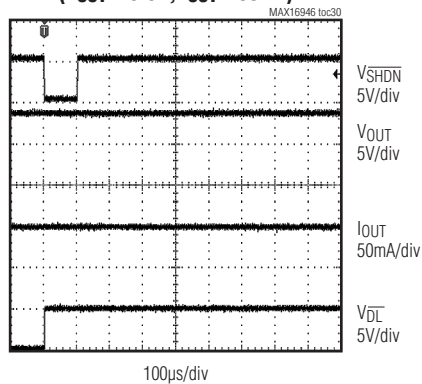

MAX16946/MAX16947

Remote Antenna, Current-Sense and LDO/Switches

Pin Configurations

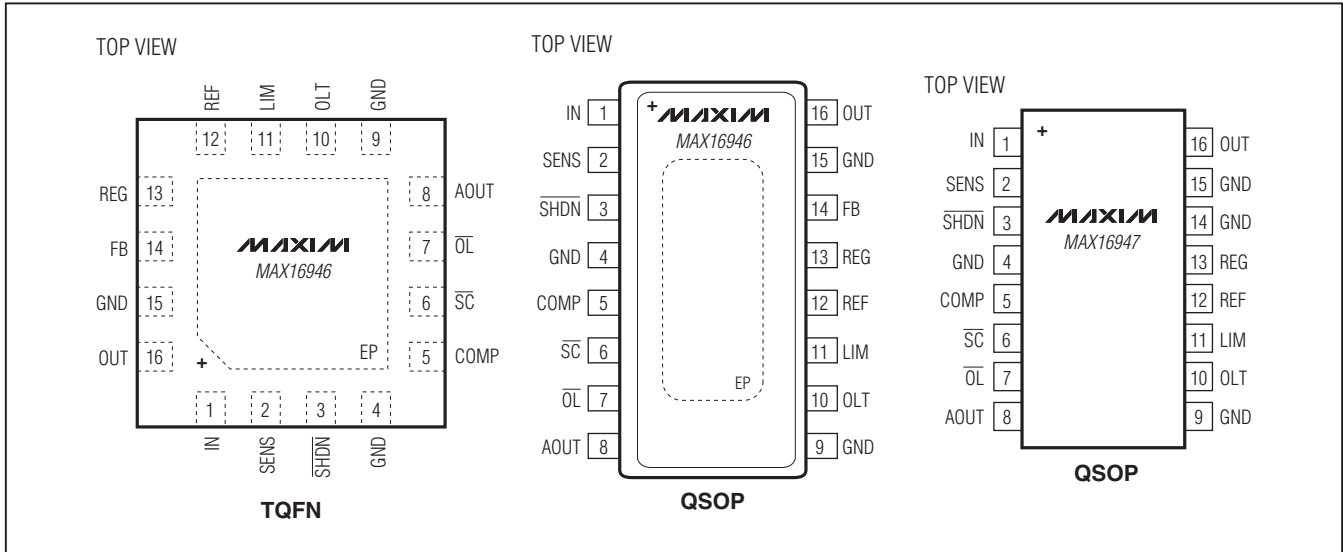

Pin Description

PIN		NAME	FUNCTION
MAX16946	MAX16947		
1	1	IN	Input Voltage. Bypass IN to GND with a low-ESR ceramic capacitor with a minimum value of 0.1µF.
2	2	SENS	Current-Sense Amplifier Input. Connect the sense resistor between SENS and IN.
3	3	$\overline{\text{SHDN}}$	Active-Low Shutdown Input. Drive $\overline{\text{SHDN}}$ low for more than 360µs to turn off the device. Pulsing $\overline{\text{SHDN}}$ low for less than $t_{\text{SHDN_OFF}}$ clears the $\overline{\text{OL}}$ output. $\overline{\text{SHDN}}$ is high-voltage compatible and is connected to IN for normal operation.
4, 9, 15	4, 9, 14, 15	GND	Ground
5	5	COMP	LDO Compensation. Connect a 0.1µF ceramic capacitor between COMP and GND to compensate the LDO.
6	6	$\overline{\text{SC}}$	Open-Drain Short-Circuit Indicator Output. $\overline{\text{SC}}$ goes low when the load current is greater than the set short-circuit current threshold or when there is a short-to-battery fault. Connect $\overline{\text{SC}}$ to a 10kΩ pullup resistor. See Table 1.
7	7	$\overline{\text{OL}}$	Open-Drain Open-Load Indicator Output. $\overline{\text{OL}}$ goes low when the load current is lower than the set open-load current threshold or when there is a short-to-battery fault. Connect $\overline{\text{OL}}$ to a 10kΩ pullup resistor. See Table 1.
8	8	AOUT	Current Monitor Voltage Output. AOUT can be used to measure the load current by means of an external ADC. AOUT has a current drive capability of 1mA. Bypass AOUT to GND with a 15nF ceramic capacitor. See Table 1.
10	10	OLT	Open-Load Current Threshold Setting Input. A resistive divider between REF, OLT, and GND sets the open-load current threshold.
11	11	LIM	Current-Limit Setting input. Connect a resistive divider from REF, LIM, and GND to set the current limit of the switch or LDO. Alternatively, externally drive LIM (not to exceed 3.65V) to set the current limit.

Remote Antenna, Current-Sense and LDO/Switches

Pin Description (continued)

PIN		NAME	FUNCTION
MAX16946	MAX16947		
12	12	REF	+3V Nominal Reference Output. REF has a current drive capability of 100μA.
13	13	REG	Internal Regulator +5V Output. REG powers all internal blocks. Do not use REG to supply power to external circuitry. Bypass REG to GND with a 1μF capacitor.
14	—	FB	Feedback Input (MAX16946 Only). Connect FB to GND to configure the MAX16946 as a switch. Connect FB to REG for an LDO with a fixed 8.5V output. Connect to the center tap of an external resistive divider connected between OUT and GND to adjust the output voltage of the LDO.
16	—	OUT	Switch or LDO Output (MAX16946 Only). OUT is either a switch or LDO output depending on the connection of FB.
—	16	OUT	Switch Output
—	—	EP	Exposed Pad (MAX16946 Only). Connect EP to the ground plane for optimal heat dissipation. Do not use EP as the only electrical ground connection.

MAX16946/MAX16947

Detailed Description

The MAX16946/MAX16947 high-voltage, high-side, current-sense LDO/switches feature internal current limiting to prevent system damage due to fault conditions. The MAX16946 provides a regulated 8.5V output voltage fixed or adjustable from 3.3V to 15V. The MAX16946 can also be configured as a switch, while the MAX16947 is only available as a switch. The input voltage range for both devices extends from 4.5V to 18V (45V tolerant), making the devices ideal for providing phantom power to remote radio-frequency low-noise amplifiers (LNAs) in automotive applications.

The devices monitor the load current and provide an analog output voltage proportional to the sensed load current. Accurate internal current-limit protects the input supply against both overload and short-circuit conditions. Two open-drain fault indicator outputs indicate to the microprocessor when a short circuit, an open-load condition, or a short-to-battery condition exists. An over-temperature shutdown is also indicated by means of the current-sense amplifier's output voltage.

A fault-blanking feature allows the devices to ignore momentary faults such as those caused by the charging of capacitive loads during hot-swapping, preventing false alarms to the system. The devices feature short-to-battery protection to latch off the internal LDO/pass switch during a short-to-battery event and thermal

overload. They include an active-low, high-voltage-compatible shutdown input to place them in low-power shutdown mode.

Current-Sense Amplifier

The integrated current-sense amplifier employs a differential amplifier that amplifies the voltage between IN and SENS. A sense resistor, R_{SENSE} , is connected across IN and SENS. Typical sense resistor values range between 0.25Ω and 2Ω . When the load current passes through the sense resistor, a voltage drop develops across it. The current-sense amplifier amplifies this voltage.

The current-sense amplifier features an internally fixed gain of $A_V = 26V/V$ (typ). The following equations show the relationship between the current-sense amplifier output voltage (V_{AOUT}) and load current:

$$(V_{IN} - V_{SENS})(V) = I_{LOAD}(A) \times R_{SENSE}(\Omega)$$

$$V_{AOUT}(V) = A_V(V/V) \times (V_{IN} - V_{SENS})(V) + 0.4V$$

If LIM is connected to REF, the maximum output voltage of AOUT is $V_{AOUT_FS} = 3V$. If LIM is externally driven to 3.65V, the maximum output voltage of AOUT extends to $V_{AOUT_FS} = 3.65V$. The maximum AOUT voltage is always equal to V_{LIM} , the voltage at LIM.

AOUT is the output of an internal buffer with 1mA current drive capability. Bypass AOUT to ground with a 15nF ceramic capacitor.

Remote Antenna, Current-Sense and LDO/Switches

Load Protection

The devices monitor the load current through an external sense resistor and perform the following actions:

- If the monitored current is lower than the set open-load current, the devices signal that there is an open-load (see the *Open Load* section).
- If the monitored current is greater than the set short-circuit current (I_{SC}), the devices enter the short-circuit mode (see the *Short Circuit and Current Limit* section).

The devices also perform a short-to-battery detection before the internal switch turns on. During normal operation, reverse-current detection protects the devices from short-to-battery events (see the *Short-to-Battery and Reverse-Current Detection* section).

In addition, thermal shutdown protects the devices from overheating (see the *Thermal Shutdown* section).

Two open-drain fault indicator outputs (\overline{OL} and \overline{SC}) and the AOUT voltage indicate the devices' status (Table 1).

Open Load

If the load current drops below the open-load current threshold, the \overline{OL} output latches low. An open-load condition does not turn off the internal switch. To unlatch the \overline{OL} output, pulse \overline{SHDN} low for less than $t_{\overline{SHDN_OFF}}$ (150 μ s min). Keeping \overline{SHDN} low for longer than $t_{\overline{SHDN_OFF}}$ shuts down the device.

The open-load current threshold is adjustable. Connect a resistive divider between REF, the open-load current threshold adjustment input (OLT), and GND to set the open-load current threshold (see the *Open-Load Current Threshold Selection* section).

Short Circuit and Current Limit

If the load current exceeds the set short-circuit current threshold (I_{SC}), the t_{BLANK} timer begins counting. During this period, the load current is limited to the current limit set by the voltage at LIM. If the overcurrent condition persists beyond t_{BLANK} , \overline{SC} asserts low and the internal switch turns off. The timer resets if the overcurrent condition disappears before the blanking time (t_{BLANK}) has elapsed.

If the switch is turned off at the end of t_{BLANK} , a retry timer (t_{RETRY}) starts immediately after the blanking time has elapsed, and during that time the switch stays off. At the end of t_{RETRY} , the switch turns on again while \overline{SC} stays low. If the fault still exists, the cycle repeats. If the fault has been removed, the switch stays on and \overline{SC} goes high after the blanking time t_{BLANK} . During retry when the switch is off, the current through the switch is zero. Blanking time and retry time have fixed values of 100ms (min) and 1100ms (min), respectively.

Figures 1–4 show the response of the devices to the presence and removal of overcurrent conditions.

The current-limit threshold is adjustable. Connect a resistive divider between REF, the current-limit setting input (LIM), and GND to set the current-limit threshold. Alternatively, externally drive LIM (not to exceed 3.65V) to set the current-limit threshold (see the *Current-Limit Threshold Selection* section).

The short-circuit current threshold depends on the value of the sense resistor and is calculated as follows:

$$I_{SC} = \frac{1.3V}{R_{SENSE} \times A_V}$$

where A_V is the gain of the internal current-sense amplifier and is equal to 26V/V and R_{SENSE} is the sense resistor value.

Remote Antenna, Current-Sense and LDO/Switches

MAX16946/MAX16947

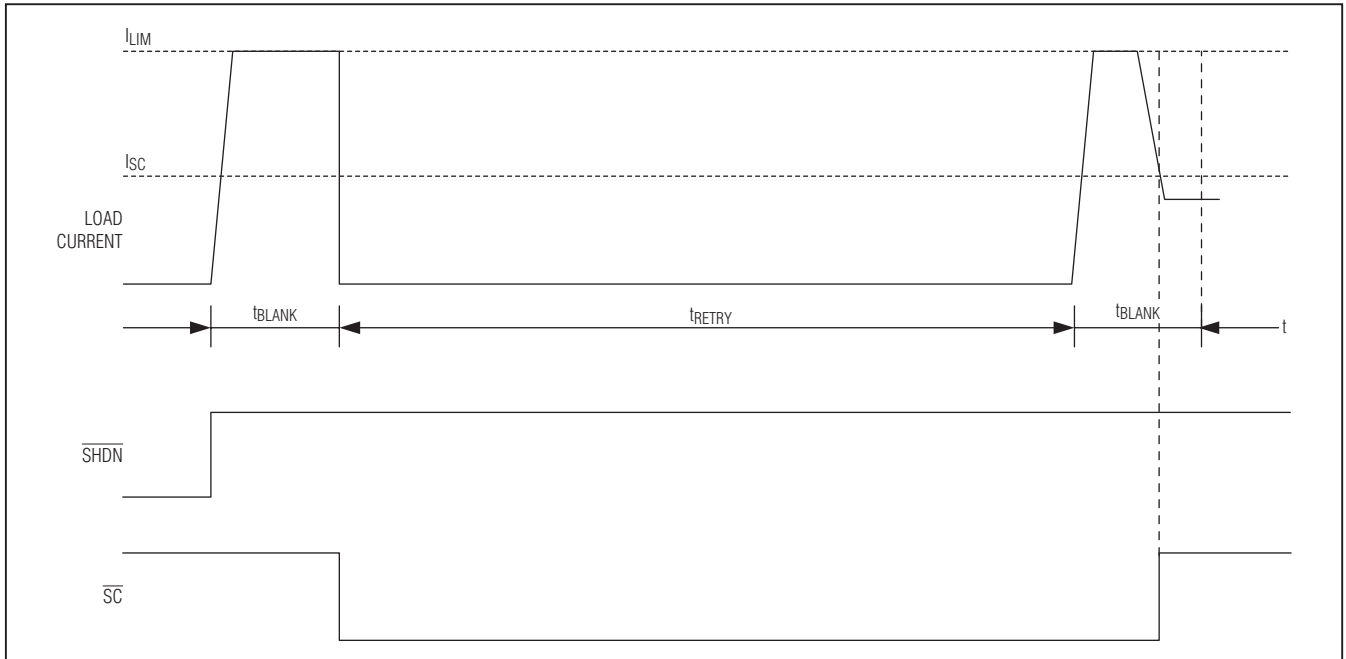

Figure 1. Turn-On into Temporary Short Circuit

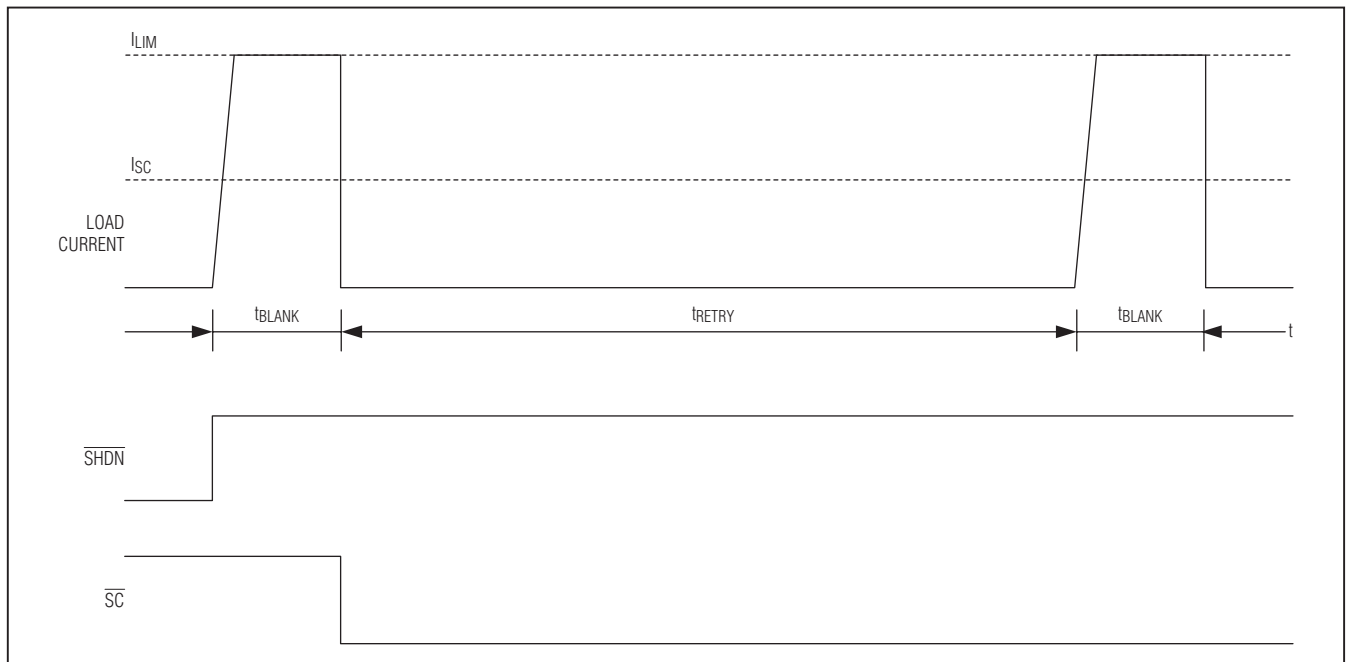

Figure 2. Turn-On into Hard Short Circuit

Remote Antenna, Current-Sense and LDO/Switches

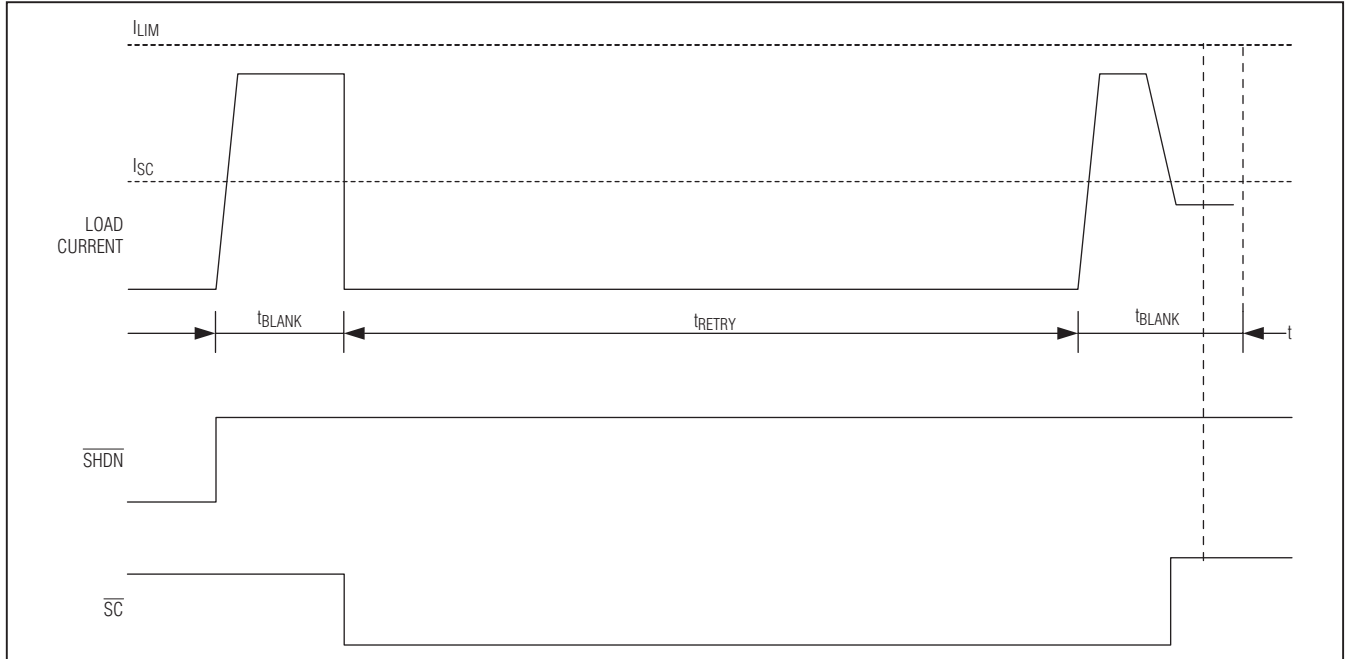

Figure 3. Turn-On into Temporary Heavy Load

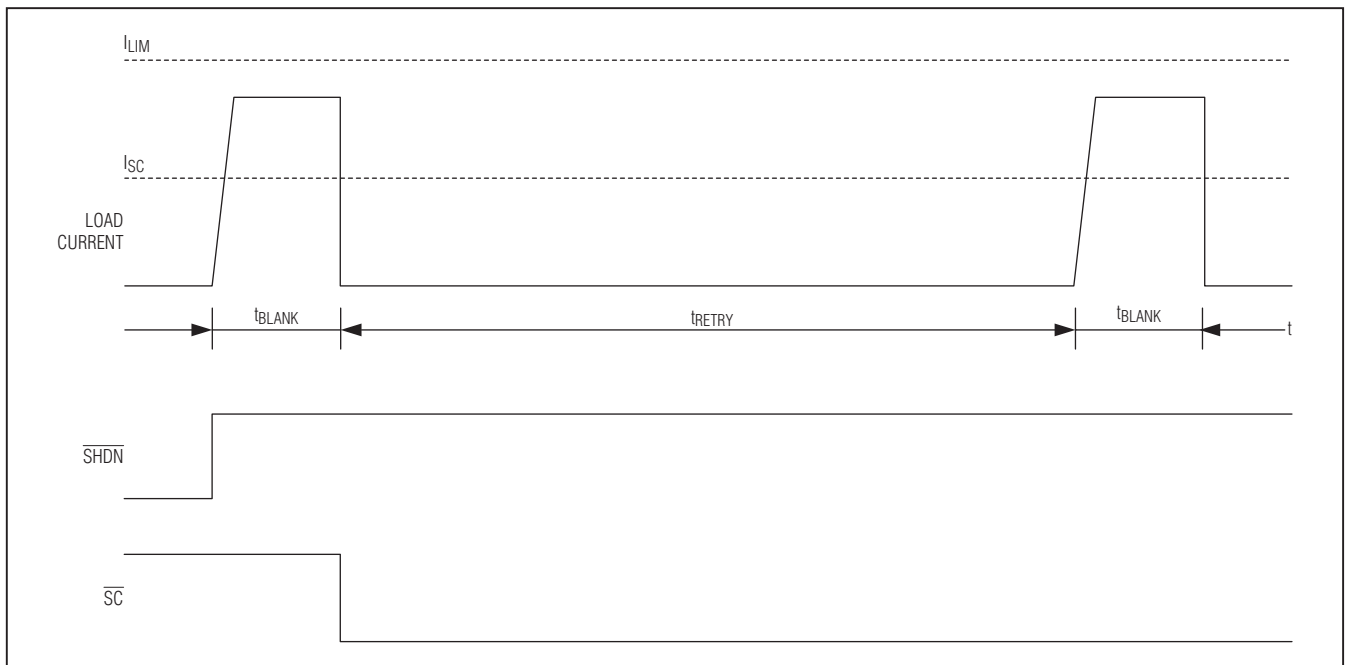

Figure 4. Turn-On into Heavy Load

Remote Antenna, Current-Sense and LDO/Switches

Short-to-Battery and Reverse-Current Detection

It is possible for OUT to be shorted to the battery due to a fault in the system. The devices detect this failure by comparing the OUT voltage and the IN voltage before the switch turns on. Every time the switch turns on, such as at the end of the retry time, or once the thermal shutdown condition disappears, the short-to-battery detection is performed. At this point, if the device detects the short-to-battery fault, the switch stays off and both \overline{SC} and \overline{OL} assert low (Table 1).

Series inductance and the output capacitor can produce ringing during a short-circuit condition, resulting in an output voltage that temporarily exceeds the input voltage. Blanking is implemented during and immediately after a short-circuit event to prevent false triggering of the reverse-current detection. The reverse-current blanking time (t_{REV_BLANK}) is 16ms (typ). If the reverse current produces a V_{SENSE} ($V_{IN} - V_{SENSE}$) less than -7.7mV (typ) for a duration greater than the blanking time, the device latches off the switch and both \overline{SC} and \overline{OL} assert low.

Thermal Shutdown

Thermal-shutdown circuitry protects the devices from overheating. The switch turns off immediately when the junction temperature exceeds +170°C (typ) (Table 1). The switch turns on again after the device temperature drops by approximately +15°C (typ). Thermal shutdown is indicated by 0V on AOUT.

Undervoltage and Overvoltage Lockout

The devices include undervoltage lockout circuitry (UVLO) to prevent erroneous switch operation when the

input voltage goes below 3.5V (typ) during startup and brownout conditions. Input voltages of less than 3.5V inhibit operation of the device by turning off the internal charge pump and the switch.

These devices also feature an overvoltage lockout (OVLO) threshold of 21V (typ). When V_{IN} is greater than V_{OVLO} , the device immediately turns off the switch and the internal charge pump.

Shutdown (\overline{SHDN})

The devices feature an active-low shutdown input (\overline{SHDN}) to place them into a low-power shutdown mode. The devices turn off and consume a 7 μ A maximum (at $V_{IN} = 12V$) of shutdown current when \overline{SHDN} is driven low for greater than 360 μ s. Driving \overline{SHDN} high initiates a device turn-on with short-to-battery detection. Pulsing \overline{SHDN} low for less than $t_{\overline{SHDN_OFF}}$ clears the \overline{OL} output.

Internal Reference (REF)

The devices feature a 3V bandgap reference output, stable over supply voltage and temperature. The reference has a current drive capability of 100 μ A. Use resistive dividers connected to REF to set the open-load current threshold and the current-limit threshold. Do not use REF to drive external circuitry.

Internal +5V Linear Regulator (REG)

The devices feature an internal regulator that regulates the input voltage to +5V to power all internal circuitry. Bypass the regulator output (REG) to GND with a 1 μ F ceramic capacitor. Do not use this regulator to power external circuitry.

Table 1. MAX16946/MAX16947 Status Truth Table

\overline{SC}	\overline{OL}	VAOUT (V)	DEVICE STATUS	ACTION TAKEN
1	1	$(I_{LOAD} \times R_{SENSE}) \times 26 + 0.4$	Normal operation	None
0	1	$(I_{LOAD} \times R_{SENSE}) \times 26 + 0.4$	Short circuit	Autoretry
1	0	$(I_{LOAD} \times R_{SENSE}) \times 26 + 0.4$	Open load	\overline{OL} latched low
0	0	0.4 after switching off	Reverse current (on-state)	Switch/LDO latched off
			OUT short-to-battery (off-state), V_{OUT} too high (LDO mode)	Switch/LDO turned off as long as condition persists
1	1	0	Thermal shutdown, V_{IN} overvoltage, V_{IN} undervoltage	Switch/LDO and AOUT turns off as long as condition persists
			REF undervoltage	Switch/LDO, AOUT, and REF turned off as long as condition persists

Remote Antenna, Current-Sense and LDO/Switches

Applications Information

Choosing the Sense Resistor

Ideally, the maximum load current develops the full-scale sense voltage across the current-sense resistor. The current-sense amplifier output voltage is given by:

$$V_{AOUT} = A_V \times (V_{IN} - V_{SENS}) + 0.4V$$

where V_{AOUT} is the output voltage of the current-sense amplifier, and A_V is the gain of the current-sense amplifier of 26V/V (typ).

Calculate the maximum value for R_{SENSE} , so that the amplified differential voltage across IN and SENS does not exceed the short-circuit AOUT voltage threshold of $V_{SC} = 1.7V$ (typ), which is defined in the *Electrical Characteristics* table:

$$R_{SENSE} = \frac{V_{SC} - 0.4V}{I_{LOAD(FULL_SCALE)} \times A_V}$$

Typical sense resistor values range between 0.25Ω and 2Ω.

During normal operation, when the load current is less than the short-circuit current threshold, the maximum AOUT voltage is equal to V_{SC} . When a short circuit to ground is present and the device goes into autoretry, the maximum AOUT voltage extends to V_{LIM} , the voltage at LIM.

Keep inductance low if I_{SENSE} has a large high-frequency component. Wire-wound resistors have the highest inductance, while metal film is somewhat better. Low-inductance, metal-film resistors are also available. Instead of being spiral wrapped around a core, as in

metal-film or wire-wound resistors, they are a straight band of metal and are available in values under 1Ω.

Because of the high current that flows through R_{SENSE} , eliminate parasitic trace resistance from causing errors in the sense voltage.

Open-Load Current Threshold Selection

A resistive divider between REF, OLT, and GND sets the open-load current threshold. See Figure 5.

Use the following formula to set the desired open-load current threshold:

$$R_2 = \frac{R_1}{\left(\frac{V_{REF}}{R_{SENSE} \times I_{OL} \times A_V + 0.4V} - 1 \right)}$$

where I_{OL} is the desired open-load current threshold, A_V is the current-sense amplifier gain (26V/V typical), and V_{REF} is the reference voltage (3V typ). Size R_1 and R_2 large enough so that the equivalent resistance of the resistive dividers used to set the open-load and current-limit thresholds does not exceed the REF output 100μA drive capability.

For example, to set the open-load current threshold at 10mA, using a 0.5Ω sense resistor, use the following method to calculate the value of R_1 and R_2 :

$$R_2 = \frac{R_1}{\left(\frac{3V}{0.5\Omega \times 0.01A \times 26V/V + 0.4V} - 1 \right)}$$

Choose $R_1 = 470k\Omega$ and calculate R_2 as 100kΩ.

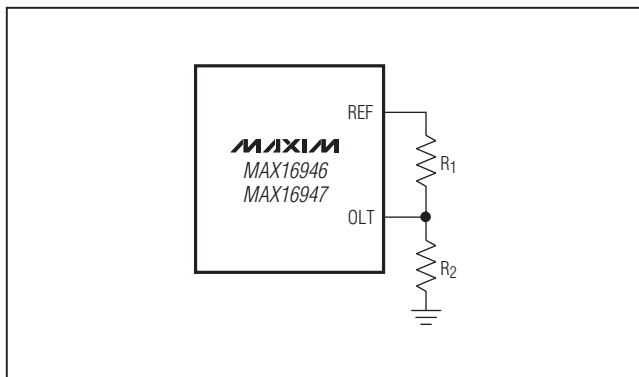

Figure 5. Open-Load Current Threshold Selection

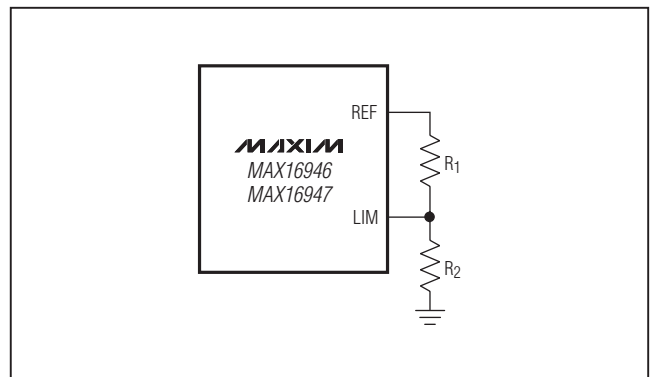

Figure 6. Current-Limit Threshold Selection

Remote Antenna, Current-Sense and LDO/Switches

Current-Limit Threshold Selection

A resistive divider between REF, LIM, and GND sets the current-limit threshold. See Figure 6.

Use the following formula to set the desired current-limit threshold:

$$R_2 = \frac{R_1}{\left(\frac{V_{REF}}{R_{SENSE} \times I_{CL} \times A_V + 0.4V} - 1 \right)}$$

where I_{CL} is the desired current-limit threshold, A_V is the current-sense amplifier gain (26V/V typ), and V_{REF} is the reference voltage (3V typ). Size R_1 and R_2 large enough so that the equivalent resistance of the resistive dividers used to set the open-load and current-limit thresholds does not exceed the REF output 100 μ A drive capability.

For example, to set the current-limit threshold at 120mA, using a 0.5 Ω sense resistor, use the following method to calculate the value of R_1 and R_2 :

$$R_2 = \frac{R_1}{\left(\frac{3V}{0.5\Omega \times 0.120A \times 26V/V + 0.4V} - 1 \right)}$$

Choose $R_1 = 83k\Omega$ and calculate R_2 as 156k Ω .

Using an External Reference

Use an external reference with resistive dividers as an alternative means of setting the current-limit and open-load current thresholds. The equations shown in the *Open-Load Current Threshold Selection* and *Current-Limit Threshold Selection* sections are still applicable when using an external reference. In those equations, set V_{REF} equal to the voltage of the external reference.

When using the devices' 3V reference, the maximum voltage at LIM is $V_{LIM} = 3V$ and is obtained by connecting LIM to REF. When using an external reference, set the voltage at LIM to no greater than $V_{LIM(MAX)} = 3.65V$.

Fixed/Adjustable Output Voltage

The MAX16946 is configurable to provide a fixed 8.5V output or as an adjustable LDO with an output between 3.3V and 15V. Connect a resistive divider between OUT, FB, and GND to set the output to the desired voltage, as shown in Figure 7. Connect FB to REG to configure the MAX16946 as an 8.5V LDO, as shown in Figure 8. FB is regulated to 1.0V with $\pm 3\%$ accuracy for a load current between 5mA and 150mA. The accuracy falls to $\pm 5\%$ for a load current between 2mA and 200mA. Select a value for R_1 and calculate R_2 as follows:

$$R_2 = \frac{R_1}{\left(\frac{V_{OUT}}{V_{FB}} - 1 \right)}$$

Select R_1 so that the maximum input bias current at FB is negligible compared to the total current going through R_1 .

Compensation Capacitor

Compensate the LDO regulator by bypassing COMP to GND with a 0.1 μ F ceramic capacitor.

Input Capacitor

Connect a low-leakage ceramic capacitor from IN to GND to limit the input-voltage drop during momentary output short-circuit conditions and to protect the device against transients due to inductance in the IN line. For example, use at least a 0.1 μ F ceramic capacitor if the input inductance (including any stray inductance) is estimated to be 20 μ H. Larger capacitor values reduce the voltage undershoot and voltage overshoot in case of reverse current at the input.

Output Capacitor

In an analogous fashion to the input capacitor, an output capacitor protects the device against transients due to any series inductance in the output. Under no conditions should the voltage on OUT go below -0.3V as specified in the *Absolute Maximum Ratings* section. A Schottky diode is required to clamp transients that go below ground. For example, with a 2.2mH series inductance, to avoid excessive ringing at the output, bypass OUT to GND with not more than 0.1 μ F capacitance. Additionally, bypassing OUT to GND with a 2.2 μ F ceramic capacitor in series with a 10 Ω resistor reduces ringing caused by load current transients through a maximum 2.2mH series inductance.

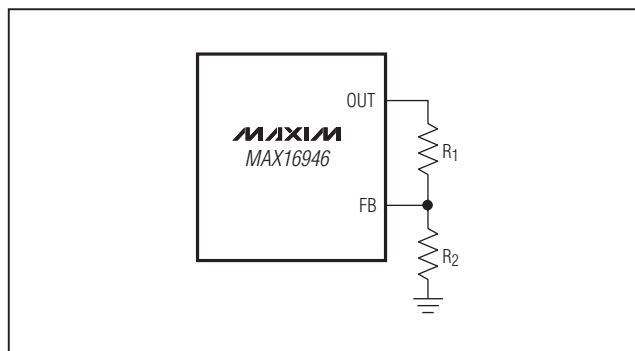

Figure 7. Adjustable Output-Voltage Selection

Remote Antenna, Current-Sense and LDO/Switches

Layout and Thermal Dissipation

To optimize the switch response time to output short-circuit condition, it is very important to keep all traces as short as possible to reduce the effect of undesirable parasitic inductance. Place input and output capacitors as close as possible to the device (no more than 5mm). IN and OUT must be connected with wide short traces to the power bus. During normal operation in switch mode, the power dissipation is small and the package temperature change is minimal. In LDO mode, the power dissipation is given by:

$$(V_{IN} - V_{OUT}) \times I_{LOAD} + V_{IN} \times I_{IN}$$

If the output is continuously shorted to ground at the maximum supply voltage, the devices are protected because the total power dissipated during the short is scaled down by the duty cycle imposed by the protection:

$$P_{(MAX)} = \frac{V_{IN(MAX)} \times I_{OUT(MAX)} \times t_{BLANK}}{t_{RETRY} + t_{BLANK}}$$

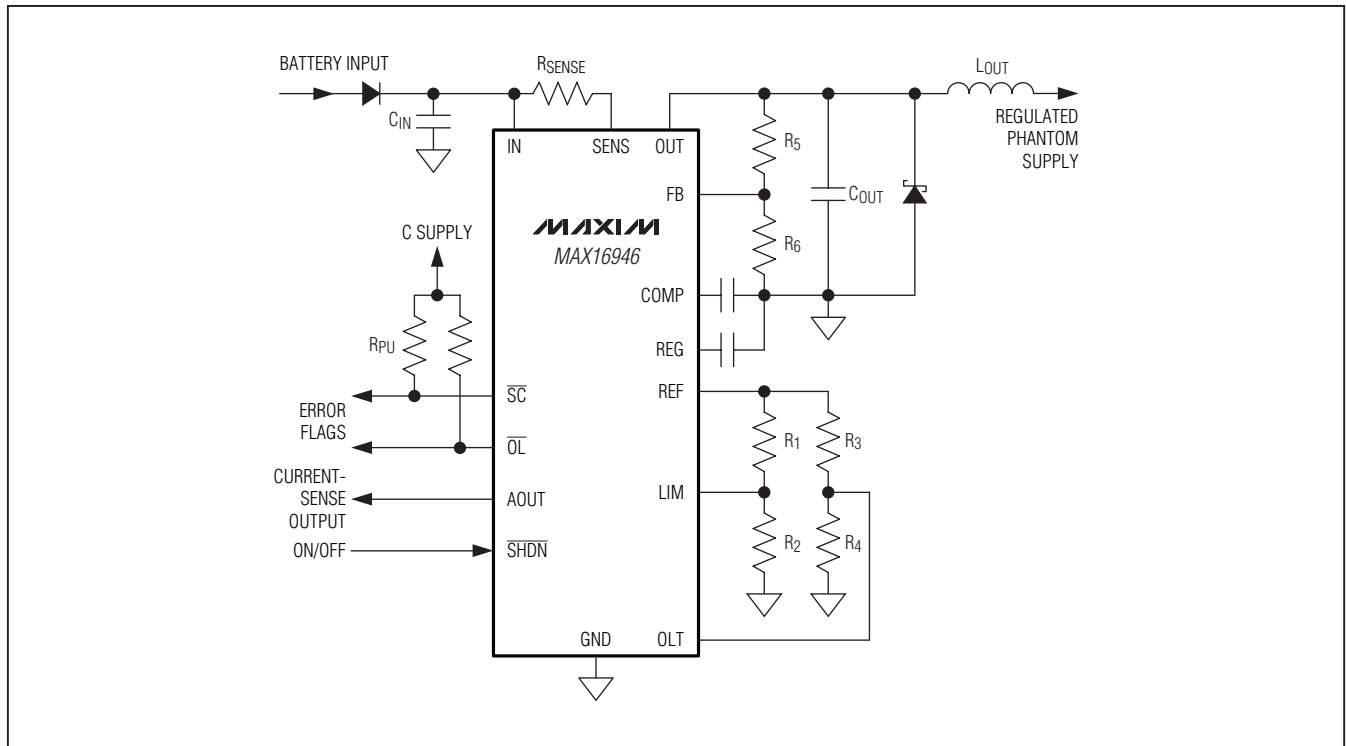

Figure 8. LDO with Adjustable Output Voltage (3.3V to 15V)

Remote Antenna, Current-Sense and LDO/Switches

MAX16946/MAX16947

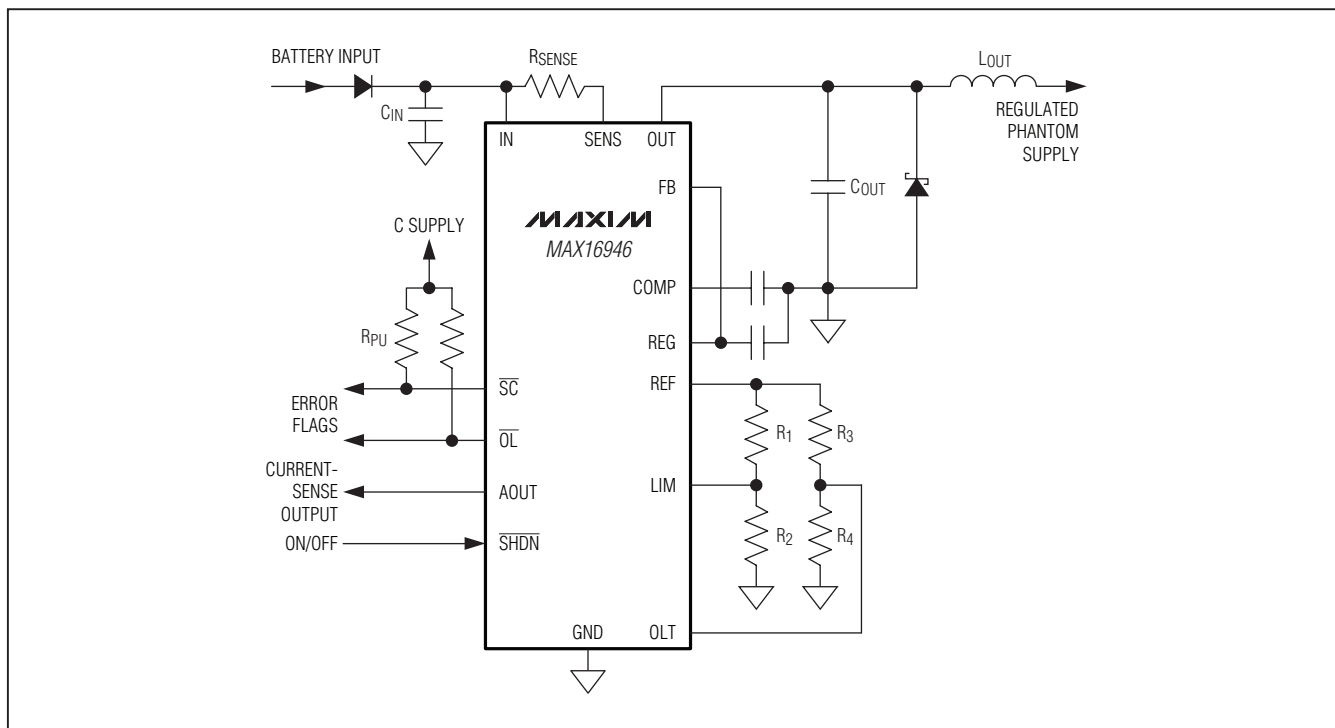

Figure 9. LDO with Fixed 8.5V Output

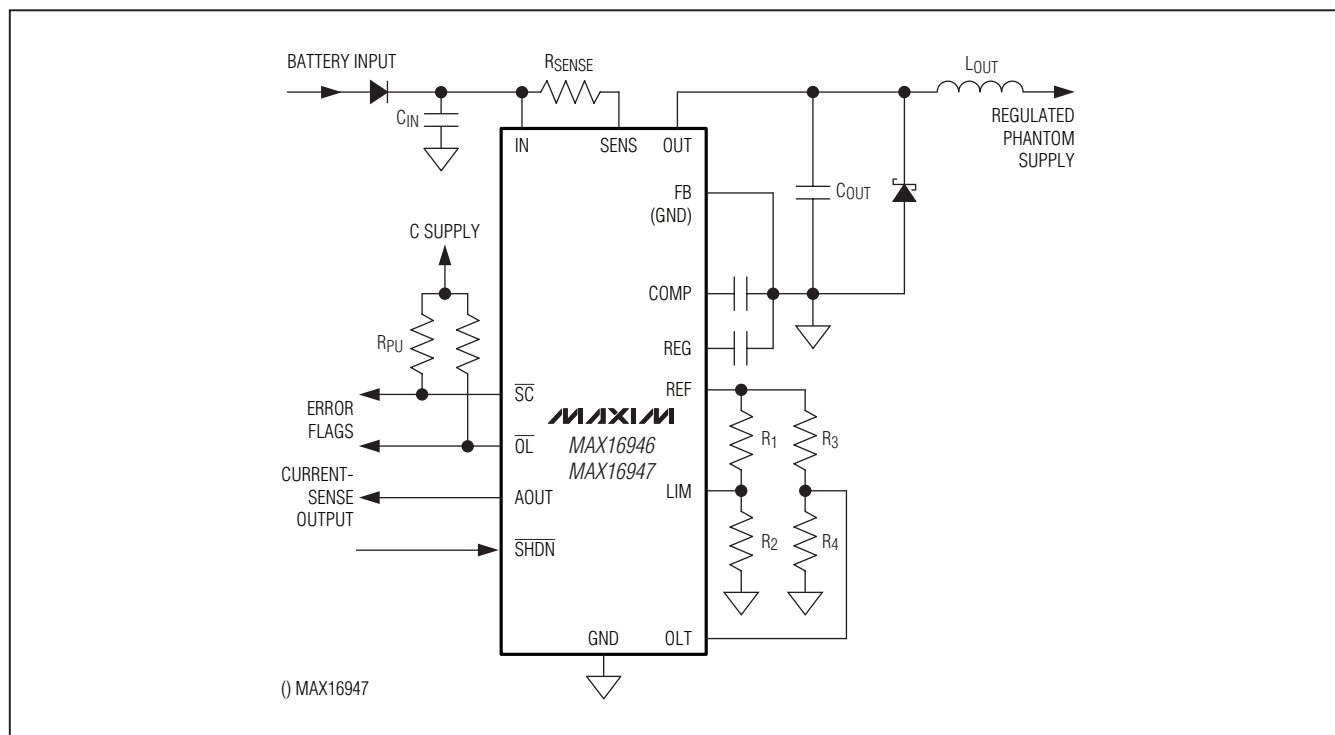

Figure 10. Input Switched to Output

Remote Antenna, Current-Sense and LDO/Switches

Chip Information

PROCESS: BiCMOS

Package Information

For the latest package outline information and land patterns, go to www.maxim-ic.com/packages. Note that a "+", "#", or "-" in the package code indicates RoHS status only. Package drawings may show a different suffix character, but the drawing pertains to the package regardless of RoHS status.

PACKAGE TYPE	PACKAGE CODE	OUTLINE NO.	LAND PATTERN NO.
16 QSOP	E16+5	21-0055	90-0167
16 QSOP-EP	E16E+10	21-0112	90-0239
16 TDFN-EP	T1644+4	21-0139	90-0070

Remote Antenna, Current-Sense and LDO/Switches

Revision History

REVISION NUMBER	REVISION DATE	DESCRIPTION	PAGES CHANGED
0	9/10	Initial release	—

MAX16946/MAX16947

Maxim cannot assume responsibility for use of any circuitry other than circuitry entirely embodied in a Maxim product. No circuit patent licenses are implied. Maxim reserves the right to change the circuitry and specifications without notice at any time.

Maxim Integrated Products, 120 San Gabriel Drive, Sunnyvale, CA 94086 408-737-7600 _____ 21



**Стандарт
Электрон
Связь**

Мы молодая и активно развивающаяся компания в области поставок электронных компонентов. Мы поставляем электронные компоненты отечественного и импортного производства напрямую от производителей и с крупнейших складов мира.

Благодаря сотрудничеству с мировыми поставщиками мы осуществляем комплексные и плановые поставки широчайшего спектра электронных компонентов.

Собственная эффективная логистика и склад в обеспечивает надежную поставку продукции в точно указанные сроки по всей России.

Мы осуществляем техническую поддержку нашим клиентам и предпродажную проверку качества продукции. На все поставляемые продукты мы предоставляем гарантию .

Осуществляем поставки продукции под контролем ВП МО РФ на предприятия военно-промышленного комплекса России , а также работаем в рамках 275 ФЗ с открытием отдельных счетов в уполномоченном банке. Система менеджмента качества компании соответствует требованиям ГОСТ ISO 9001.

Минимальные сроки поставки, гибкие цены, неограниченный ассортимент и индивидуальный подход к клиентам являются основой для выстраивания долгосрочного и эффективного сотрудничества с предприятиями радиоэлектронной промышленности, предприятиями ВПК и научно-исследовательскими институтами России.

С нами вы становитесь еще успешнее!

Наши контакты:

Телефон: +7 812 627 14 35

Электронная почта: sales@st-electron.ru

Адрес: 198099, Санкт-Петербург,
Промышленная ул, дом № 19, литера Н,
помещение 100-Н Офис 331