

## IF140, IF140A N-Channel JFET

### Features

- InterFET [N0014L Geometry](#)
- Low Noise: 4 nV/√Hz Typical
- High Gain: 4.5mS Typical
- Low Ciss: 3.0pF Maximum
- Replacement for IF142
- RoHS Compliant
- SMT, TH, and Bare Die Package options.

### Applications

- Low Noise, High Gain Amplifiers

### Description

The -20V InterFET IF140 and IF140A are targeted for low noise high gain amplifier stages for mid to high frequencies designs. Gate leakages are typically 2pA at room temperatures. The TO-72 package is hermetically sealed and suitable for military applications.

TO-72 Bottom View

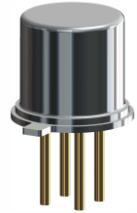
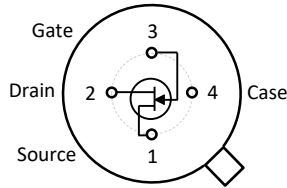

SOT23 Top View

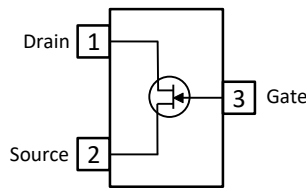

### Product Summary

Parameters	IF140 Min	IF140A Min	Unit
BV <sub>GSS</sub> Gate to Source Breakdown Voltage	-20	-20	V
I <sub>DSS</sub> Drain to Source Saturation Current	5	5	mA
V <sub>GS(off)</sub> Gate to Source Cutoff Voltage	-0.3	-0.3	V
G <sub>FS</sub> Forward Transconductance	3.5	3.5	mS

### Ordering Information Custom Part and Binning Options Available

Part Number	Description	Case	Packaging
IF140T72; IF140AT72	Through-Hole	TO-72	Bulk
IF140ST3; IF140AST3	Surface Mount	SOT23	Bulk
IF140ST3TR; IF140AST3TR	7" Tape and Reel: Max 3,000 Pieces 13" Tape and Reel: Max 9,000 Pieces	SOT23	Minimum 1,000 Pieces Tape and Reel
IF140COT; IF140ACOT	Chip Orientated Tray (COT Waffle Pack)	COT	400/Waffle Pack
IF140CFT; IF140ACFT	Chip Face-up Tray (CFT Waffle Pack)	CFT	400/Waffle Pack



**Disclaimer:** It is the Buyers responsibility for designing, validating and testing the end application under all field use cases and extreme use conditions. Guaranteeing the application meets required standards, regulatory compliance, and all safety and security requirements is the responsibility of the Buyer. These resources are subject to change without notice.

## Electrical Characteristics

### Maximum Ratings (@ $T_A = 25^\circ\text{C}$ , Unless otherwise specified)

Parameters	Value	Unit
$V_{RGS}$ Reverse Gate Source and Gate Drain Voltage	-20	V
$I_{FG}$ Continuous Forward Gate Current	10	mA
$P_D$ Continuous Device Power Dissipation	375	mW
$P$ Power Derating	3	mW/ $^\circ\text{C}$
$T_J$ Operating Junction Temperature	-55 to 125	$^\circ\text{C}$
$T_{STG}$ Storage Temperature	-65 to 200	$^\circ\text{C}$

### Static Characteristics (@ $T_A = 25^\circ\text{C}$ , Unless otherwise specified)

Parameters	Conditions	IF140		IF140A		Unit
		Min	Max	Min	Max	
$V_{(BR)GSS}$ Gate to Source Breakdown Voltage	$V_{DS} = 0V, I_G = -1\mu\text{A}$	-20		-20		V
$I_{GSS}$ Gate to Source Reverse Current	$V_{GS} = -15V, V_{DS} = 0V, T_A = 25^\circ\text{C}$		-0.1		-0.1	nA
	$V_{GS} = -15V, V_{DS} = 0V, T_A = 150^\circ\text{C}$		-0.2		-0.2	nA
$V_{GS(F)}$ Gate to Source Forward Voltage	$V_{DS} = 0V, I_G = 1\text{mA}$		1		1	V
$V_{GS(OFF)}$ Gate to Source Cutoff Voltage	$V_{DS} = 15V, I_D = 5\text{nA}$		-6		-6	V
$V_{GS}$ Gate to Source Voltage	$V_{DS} = 15V, I_D = 50\mu\text{A}$		-5	-2.5	-6	V
$I_{DSS}$ Drain to Source Saturation Current	$V_{GS} = 0V, V_{DS} = 15V$ (Pulsed)	5	15	5	15	mA

### Dynamic Characteristics (@ $T_A = 25^\circ\text{C}$ , Unless otherwise specified)

Parameters	Conditions	IF140		IF140A		Unit
		Min	Max	Min	Max	
$G_{FS}$ Forward Transconductance	$V_{DS} = 15V, V_{GS} = 0V, f = 1\text{kHz}$	3.5		3.5		mS
$G_{OS}$ Output Conductance	$V_{DS} = 15V, V_{GS} = 0V, f = 1\text{kHz}$		0.05		0.05	mS
$C_{iss}$ Input Capacitance	$V_{DS} = 15V, V_{GS} = 0V, f = 1\text{MHz}$		3		3	pF
$C_{rss}$ Reverse Transfer Capacitance	$V_{DS} = 15V, V_{GS} = 0V, f = 1\text{MHz}$		0.6		0.6	pF
$e_n$ Equivalent Circuit Input Noise Voltage	$V_{DS} = 12V, V_{GS} = 0V, f = 10\text{Hz}$	4 (typ)		4 (typ)		nV/ $\sqrt{\text{Hz}}$

## Typical IF140 Characteristics

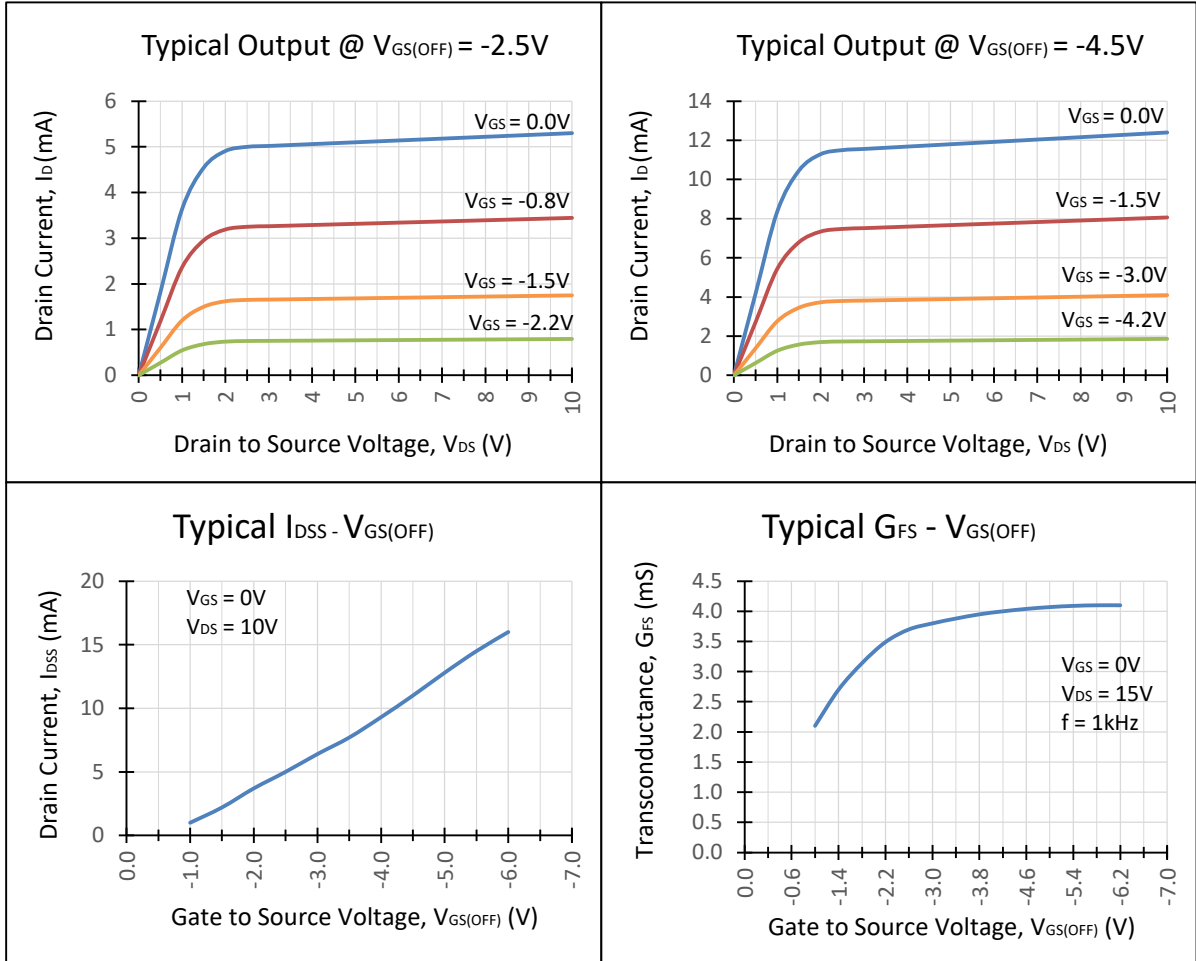

**Typical IF140 Characteristics (Continued)**

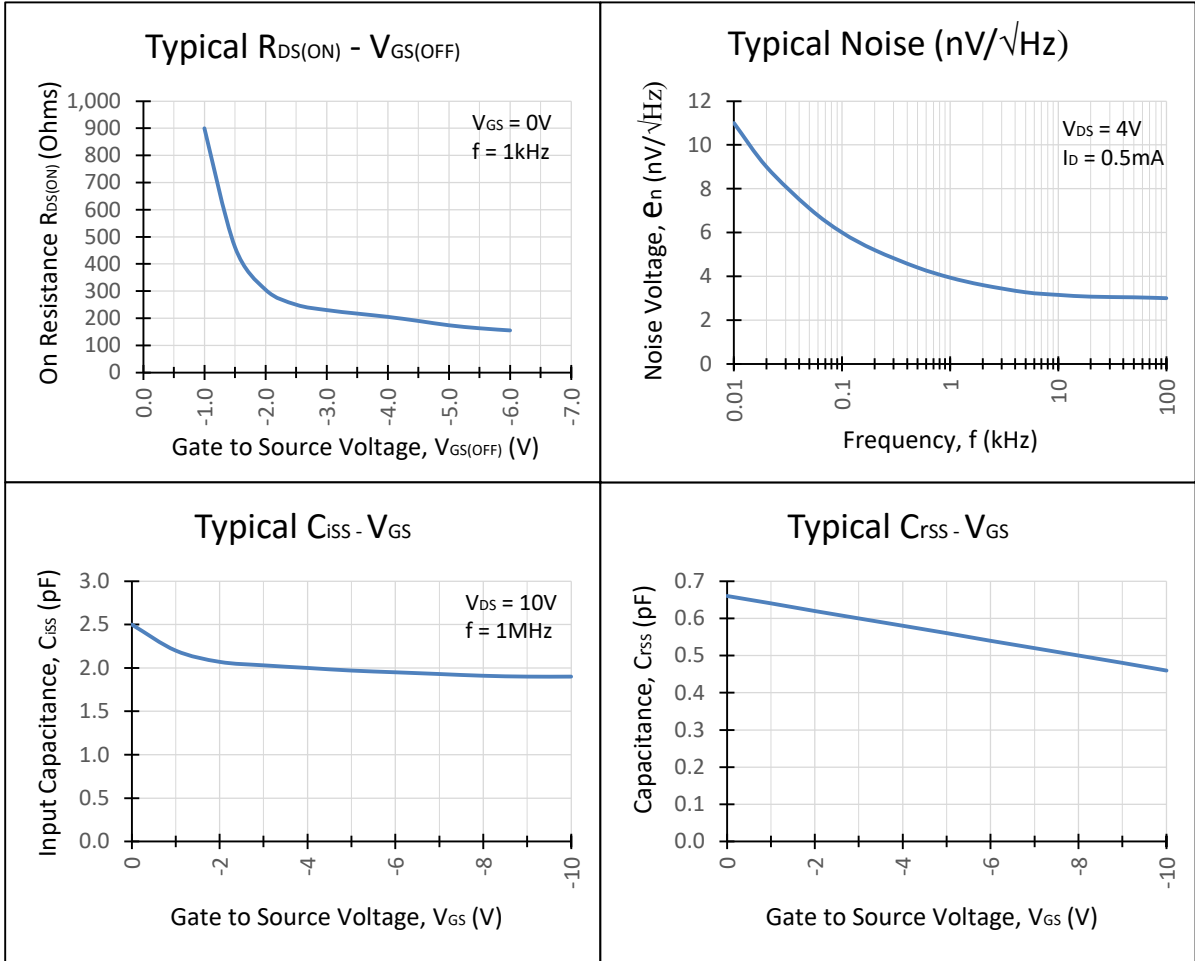

## SOT23 (TO-236AB) Mechanical and Layout Data

### Package Outline Data



1. All linear dimensions are in millimeters.
2. Package weight approximately 0.12 grams
3. Molded plastic case UL 94V-0 rated
4. For Tape and Reel specifications refer to InterFET CTC-021 Tape and Reel Specification, Document number: IF39002
5. Bulk product is shipped in standard ESD shipping material
6. Refer to JEDEC standards for additional information.

### Suggested Pad Layout



1. All linear dimensions are in millimeters.
2. The suggested land pattern dimensions have been provided for reference only. A more robust pattern may be desired for wave soldering.

## TO-72 Mechanical and Layout Data

### Package Outline Data

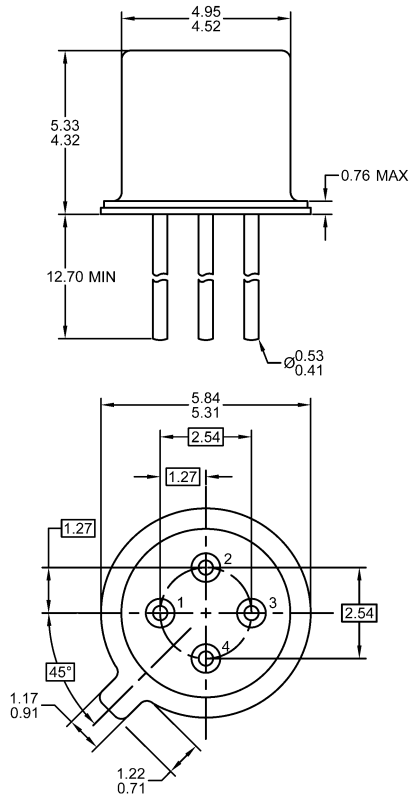

1. All linear dimensions are in millimeters.
2. Four leaded device. Not all leads are shown in drawing views.
3. Package weight approximately 0.31 grams
4. Bulk product is shipped in standard ESD shipping material
5. Refer to JEDEC standards for additional information.

### Suggested Through-Hole Layout

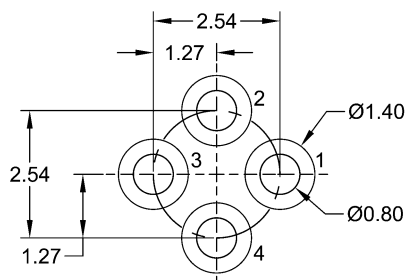

1. All linear dimensions are in millimeters.
2. The suggested land pattern dimensions have been provided as a straight lead reference only. A more robust pattern may be desired for wave soldering and/or bent lead configurations.



## Стандарт Электрон Связь

Мы молодая и активно развивающаяся компания в области поставок электронных компонентов. Мы поставляем электронные компоненты отечественного и импортного производства напрямую от производителей и с крупнейших складов мира.

Благодаря сотрудничеству с мировыми поставщиками мы осуществляем комплексные и плановые поставки широчайшего спектра электронных компонентов.

Собственная эффективная логистика и склад в обеспечивает надежную поставку продукции в точно указанные сроки по всей России.

Мы осуществляем техническую поддержку нашим клиентам и предпродажную проверку качества продукции. На все поставляемые продукты мы предоставляем гарантию .

Осуществляем поставки продукции под контролем ВП МО РФ на предприятия военно-промышленного комплекса России , а также работаем в рамках 275 ФЗ с открытием отдельных счетов в уполномоченном банке. Система менеджмента качества компании соответствует требованиям ГОСТ ISO 9001.

Минимальные сроки поставки, гибкие цены, неограниченный ассортимент и индивидуальный подход к клиентам являются основой для выстраивания долгосрочного и эффективного сотрудничества с предприятиями радиоэлектронной промышленности, предприятиями ВПК и научно-исследовательскими институтами России.

С нами вы становитесь еще успешнее!

### Наши контакты:

**Телефон:** +7 812 627 14 35

**Электронная почта:** [sales@st-electron.ru](mailto:sales@st-electron.ru)

**Адрес:** 198099, Санкт-Петербург,  
Промышленная ул, дом № 19, литера Н,  
помещение 100-Н Офис 331