

Great for Irregularities and Lamination, an Easy-to-use Mark Sensor





 Be sure to read *Safety Precautions* on page 5.

Ordering Information

Sensors



 Green

Appearance	Connection method	Sensing distance	Spot diameter	Model	
				NPN output	PNP output
	Connector (M12)*	 10 ± 3 mm	1 × 4 mm	E3M-VG11	E3M-VG16
			4 × 1 mm	E3M-VG21	E3M-VG26



* Switchable between vertical and horizontal directions with a rotation connector.

Accessories (Order Separately)





Mounting Brackets

Appearance	Model	Quantity	Remarks
	E39-L131	1	---
	E39-L132	1	For rear mounting

Sensor I/O Connectors

Cable	Appearance	Cable type	Model
Standard	Straight 	2 m	XS2F-D421-D80-A
		5 m	XS2F-D421-G80-A
	L-shaped 	2 m	XS2F-D422-D80-A
		5 m	XS2F-D422-G80-A

Ratings and Specifications

Item	Model	E3M-VG11	E3M-VG21	E3M-VG16	E3M-VG26
Sensing distance		10 ± 3 mm			
Spot size (horizontal × vertical) *4		1 × 4 mm 	4 × 1 mm 	1 × 4 mm 	4 × 1 mm 
Light source (wavelength)		Green LED (525 nm)			
Power supply voltage		10 to 30 VDC including 10% (p.p) ripple			
Current consumption		100 mA max.			
Control output		Load power supply voltage: 30 VDC max., Load current: 100 mA max. (Residual voltage: 1.2 V max.), NPN open collector output		Load power supply voltage: 30 VDC max., Load current: 100 mA max. (Residual voltage: 2 V max.), PNP open collector output	
Remote control input *1		ON: Short-circuit to 0 V or 1.5 V max. (Outflow current 1 mA max.) OFF: Open or Vcc-1.5 V to Vcc (Leakage current 0.1 mA max.)		ON: Vcc-1.5 V to Vcc (Inlet current 3 mA max.) OFF: Open or 1.5 V max. (Leakage current 0.1 mA max.)	
Remote control output *1		Load power supply voltage: 30 VDC max., Load current: 100 mA max. (Residual voltage: 1.2 V max.), NPN open collector output		Load power supply voltage: 30 VDC max., Load current: 100 mA max. (Residual voltage: 2 V max.), PNP open collector output	
Bank selection		2-bank selection (Performed by remote control only. Refer to the remote control function for details.)			
Protective circuits		Power supply reverse polarity protection, Load short-circuit protection			
Response time		ON: 50 μs max., OFF: 70 μs max.			
Sensitivity adjustment		Teaching system			
Ambient illumination (Receiver side)		Incandescent lamp: 3,000 lx max., Sunlight 10,000 lx max.			
Ambient temperature range		Operating: -20 to 55°C, Storage: -30 to 70°C (with no icing)			
Ambient humidity range		Operating: 35% to 85%, Storage: 35% to 95% (with no condensation)			
Insulation resistance		20 MΩmin. at 500 VDC			
Dielectric strength		1,000 VAC, 50/60 Hz for 1 min			
Vibration resistance *2		Destruction: 10 to 55 Hz, 1-mm double amplitude or 150 m/s ² for 2 hours each in X, Y and Z directions			
Shock resistance *3		Destruction: 500 m/s ² 3 times each in X, Y and Z directions			
Degree of protection		IEC 60529 IP67 (with Protective Cover attached)			
Connection method		M12 Connector			
Weight (packed state)		Approx. 100 g			
Material	Case	PBT (polybutylene terephthalate)			
	Lens	Mechacrylic resin			
Accessories		Instruction manual			

*1. A single cable is shared for remote control input and answer-back output.

*2. 0.75-mm double amplitude or 100 m/s² when using a Mounting Bracket.

*3. 300 m/s² when using a Mounting Bracket.

*4. The spot size is measured with the light emitter facing forward and the Sensor body standing vertically.

Engineering Data (Typical)

Sensing Distance vs Incident Level Characteristics

E3M-VG1□

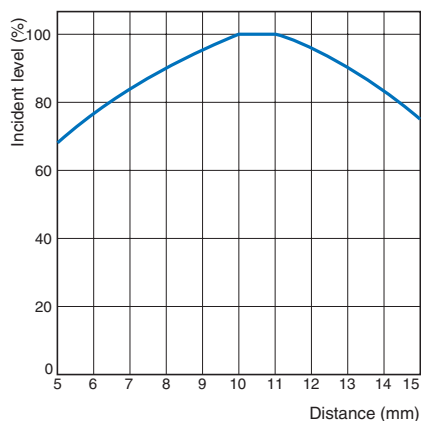

Angle - Incident Level Characteristics (X Direction)

E3M-VG1□/-VG2□

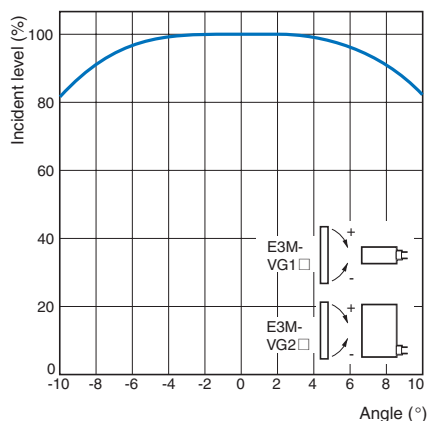

Angle - Incident Level Characteristics (Y Direction)

E3M-VG1□/-VG2□

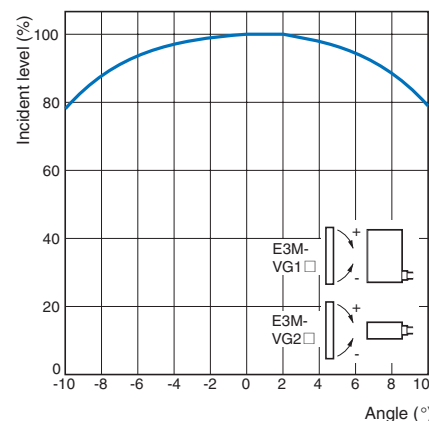

Color Detection

E3M-VG□□

	White	Red	Yellow/red	Yellow	Yellow/green	Green	Blue/green	Blue	Purple	Red/purple	Black
White	○	○	○	○	○	○	○	○	○	○	○
Red	○	○	○	○	○	○	○	○	○	×	△
Yellow/red	○	○	○	○	○	○	○	○	×	○	○
Yellow	○	○	○	○	○	○	○	○	○	○	○
Yellow/green	○	○	○	○	○	○	○	○	○	○	○
Green	○	○	○	○	○	○	○	○	○	○	○
Blue/green	○	○	○	○	○	○	○	△	○	○	○
Blue	○	○	○	○	○	○	△	△	○	○	○
Purple	○	○	×	○	○	○	○	△	○	○	○
Red/purple	○	×	○	○	○	○	○	○	○	○	×
Black	○	△	○	○	○	○	○	○	○	×	○

○: Detectable △: Detectable but unstable ×: Not detectable

Difference in Incident Level by Color Conditions

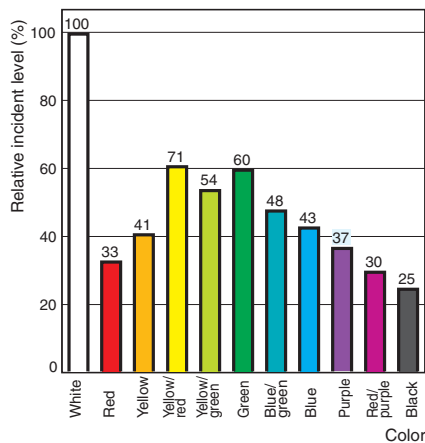

Standard Sensing Object and Colors (Standard Color Card (230 Colors) for Japan Color Enterprise Co., Ltd.)

Color (11 standard colors)	Munsell color notation
White	N9.5
Red	4R 4.5/12.0
Yellow/red	4YR 6.0/11.5
Yellow	5Y 8.5/11.0
Yellow/green	3GY 6.5/10.0
Green	3G 6.5/9.0
Blue/green	5BG 4.5/10.0
Blue	3PB 5.0/10.0
Purple	7P 5.0/10.0
Red/purple	6RP 4.5/12.5
Black	N2.0

I/O Circuit Diagrams

NPN output

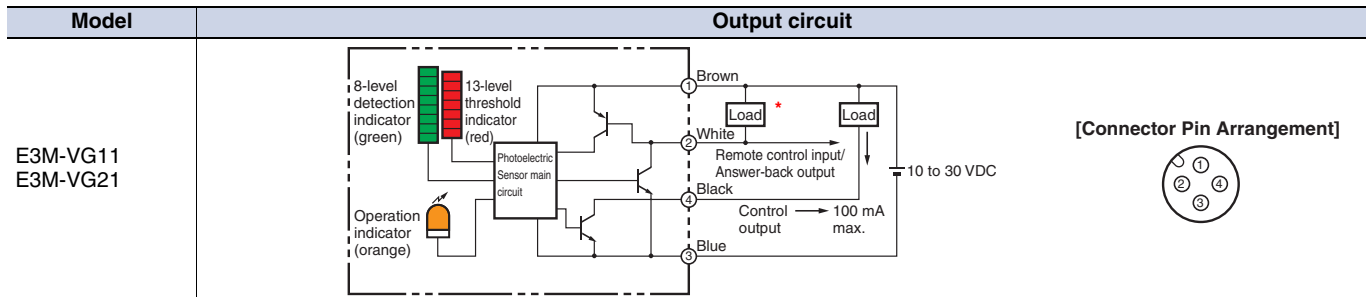

* A single cable is shared for remote control input and answer-back output. Be sure to install a load as shown in the diagram for the remote control function.

PNP output

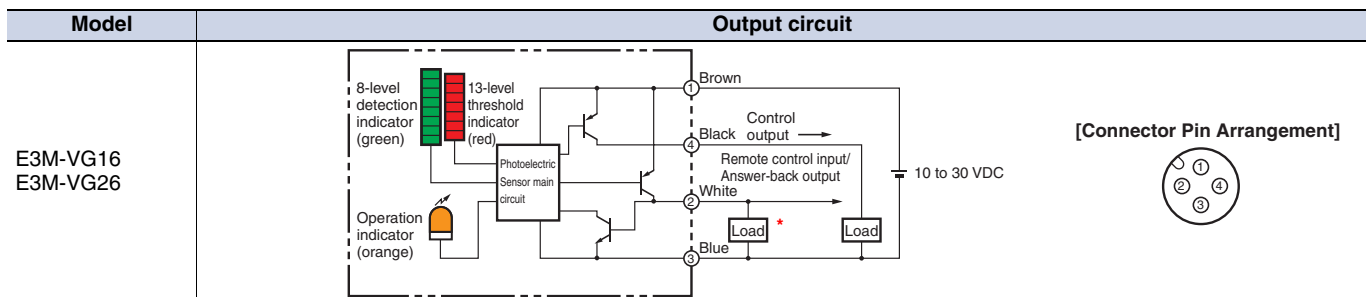

* A single cable is shared for remote control input and answer-back output. Be sure to install a load as shown in the diagram for the remote control function.

Plug (Sensor I/O Connector)

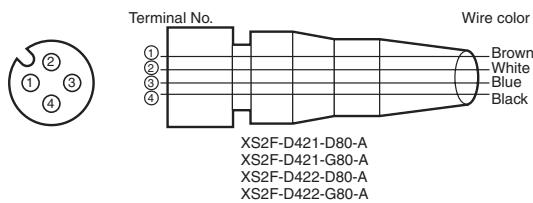

Class	Wire color	Connector pin No.	Application
DC	Brown	1	Power supply (+V)
	White	2	*
	Blue	3	Power supply (0 V)
	Black	4	Output

* Used for both of remote control input and answer-back output

Technical Guide

Detection of Metal or Glossy Objects

Color detection can be improved by inclining the Sensor to prevent it from picking up regular reflection.

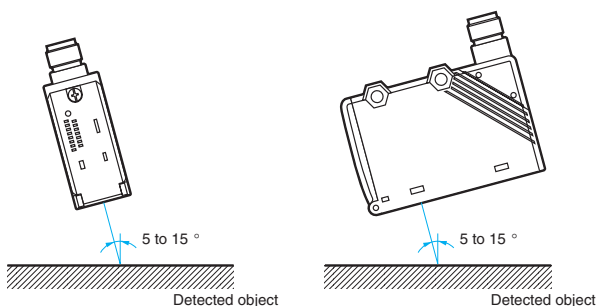

Nomenclature

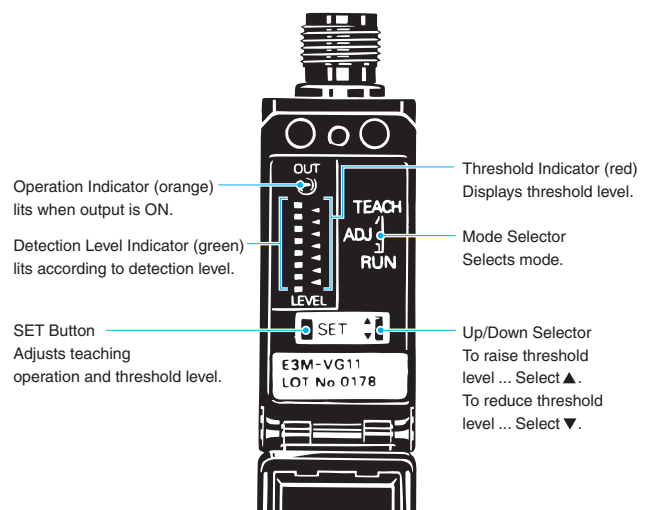

Safety Precautions

Refer to *Warranty and Limitations of Liability*.

 **WARNING**

This product is not designed or rated for ensuring safety of persons either directly or indirectly. Do not use it for such purposes.



Precautions for Correct Use

Do not use the product in atmospheres or environments that exceed product ratings.

● Designing

Power Supply

A power supply with full- or half-wave rectification cannot be connected.

● Wiring

Tensile Strength of Cables

The tensile strength of the cable should not exceed 50 N.

● Mounting

Tightening Force

The tightening force applied to the Fiber Unit should not exceed 1.2 N·m.

Mounting the Sensor

If Sensors are mounted face-to-face, make sure that the optical axes are not in opposition to each other. Otherwise, mutual interference may result.

● Others

EEPROM Writing Error

An EEPROM error may result if the power supply to the Sensor fails or the Sensor is influenced by static noise. The threshold indicators will flash if there is an EEPROM error, in which case perform teaching and make threshold level settings again.

(Unit: mm)

Dimensions

Unless otherwise specified, the tolerance class IT16 is used for dimensions in this data sheet.

Sensors

E3M-VG

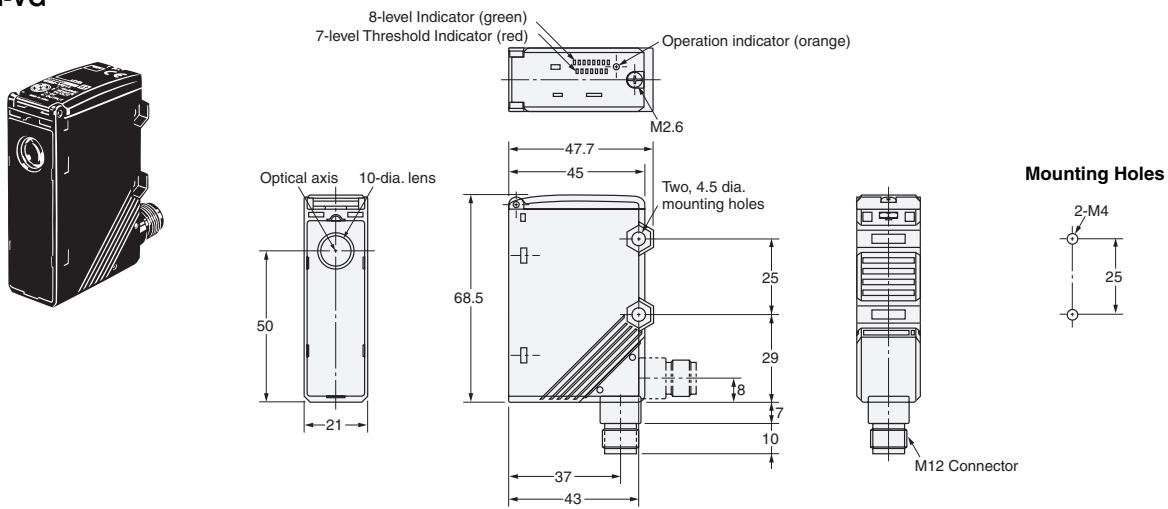

Accessories (Order Separately)

Mounting Brackets

Read and Understand This Catalog

Please read and understand this catalog before purchasing the products. Please consult your OMRON representative if you have any questions or comments.

Warranty and Limitations of Liability

WARRANTY

OMRON's exclusive warranty is that the products are free from defects in materials and workmanship for a period of one year (or other period if specified) from date of sale by OMRON.

OMRON MAKES NO WARRANTY OR REPRESENTATION, EXPRESS OR IMPLIED, REGARDING NON-INFRINGEMENT, MERCHANTABILITY, OR FITNESS FOR PARTICULAR PURPOSE OF THE PRODUCTS. ANY BUYER OR USER ACKNOWLEDGES THAT THE BUYER OR USER ALONE HAS DETERMINED THAT THE PRODUCTS WILL SUITABLY MEET THE REQUIREMENTS OF THEIR INTENDED USE. OMRON DISCLAIMS ALL OTHER WARRANTIES, EXPRESS OR IMPLIED.

LIMITATIONS OF LIABILITY

OMRON SHALL NOT BE RESPONSIBLE FOR SPECIAL, INDIRECT, OR CONSEQUENTIAL DAMAGES, LOSS OF PROFITS OR COMMERCIAL LOSS IN ANY WAY CONNECTED WITH THE PRODUCTS, WHETHER SUCH CLAIM IS BASED ON CONTRACT, WARRANTY, NEGLIGENCE, OR STRICT LIABILITY.

In no event shall the responsibility of OMRON for any act exceed the individual price of the product on which liability is asserted.

IN NO EVENT SHALL OMRON BE RESPONSIBLE FOR WARRANTY, REPAIR, OR OTHER CLAIMS REGARDING THE PRODUCTS UNLESS OMRON'S ANALYSIS CONFIRMS THAT THE PRODUCTS WERE PROPERLY HANDLED, STORED, INSTALLED, AND MAINTAINED AND NOT SUBJECT TO CONTAMINATION, ABUSE, MISUSE, OR INAPPROPRIATE MODIFICATION OR REPAIR.

Application Considerations

SUITABILITY FOR USE

OMRON shall not be responsible for conformity with any standards, codes, or regulations that apply to the combination of products in the customer's application or use of the products.

At the customer's request, OMRON will provide applicable third party certification documents identifying ratings and limitations of use that apply to the products. This information by itself is not sufficient for a complete determination of the suitability of the products in combination with the end product, machine, system, or other application or use.

The following are some examples of applications for which particular attention must be given. This is not intended to be an exhaustive list of all possible uses of the products, nor is it intended to imply that the uses listed may be suitable for the products:

- Outdoor use, uses involving potential chemical contamination or electrical interference, or conditions or uses not described in this catalog.
- Nuclear energy control systems, combustion systems, railroad systems, aviation systems, medical equipment, amusement machines, vehicles, safety equipment, and installations subject to separate industry or government regulations.
- Systems, machines, and equipment that could present a risk to life or property.

Please know and observe all prohibitions of use applicable to the products.

NEVER USE THE PRODUCTS FOR AN APPLICATION INVOLVING SERIOUS RISK TO LIFE OR PROPERTY WITHOUT ENSURING THAT THE SYSTEM AS A WHOLE HAS BEEN DESIGNED TO ADDRESS THE RISKS, AND THAT THE OMRON PRODUCTS ARE PROPERLY RATED AND INSTALLED FOR THE INTENDED USE WITHIN THE OVERALL EQUIPMENT OR SYSTEM.

PROGRAMMABLE PRODUCTS

OMRON shall not be responsible for the user's programming of a programmable product, or any consequence thereof.

Disclaimers

CHANGE IN SPECIFICATIONS

Product specifications and accessories may be changed at any time based on improvements and other reasons.

It is our practice to change model numbers when published ratings or features are changed, or when significant construction changes are made. However, some specifications of the products may be changed without any notice. When in doubt, special model numbers may be assigned to fix or establish key specifications for your application on your request. Please consult with your OMRON representative at any time to confirm actual specifications of purchased products.

DIMENSIONS AND WEIGHTS

Dimensions and weights are nominal and are not to be used for manufacturing purposes, even when tolerances are shown.

PERFORMANCE DATA

Performance data given in this catalog is provided as a guide for the user in determining suitability and does not constitute a warranty. It may represent the result of OMRON's test conditions, and the users must correlate it to actual application requirements. Actual performance is subject to the OMRON Warranty and Limitations of Liability.

ERRORS AND OMISSIONS

The information in this document has been carefully checked and is believed to be accurate; however, no responsibility is assumed for clerical, typographical, or proofreading errors, or omissions.

2011.9

In the interest of product improvement, specifications are subject to change without notice.

OMRON Corporation
Industrial Automation Company

<http://www.ia.omron.com/>

(c)Copyright OMRON Corporation 2011 All Right Reserved.



Стандарт Электрон Связь

Мы молодая и активно развивающаяся компания в области поставок электронных компонентов. Мы поставляем электронные компоненты отечественного и импортного производства напрямую от производителей и с крупнейших складов мира.

Благодаря сотрудничеству с мировыми поставщиками мы осуществляем комплексные и плановые поставки широчайшего спектра электронных компонентов.

Собственная эффективная логистика и склад в обеспечивает надежную поставку продукции в точно указанные сроки по всей России.

Мы осуществляем техническую поддержку нашим клиентам и предпродажную проверку качества продукции. На все поставляемые продукты мы предоставляем гарантию .

Осуществляем поставки продукции под контролем ВП МО РФ на предприятия военно-промышленного комплекса России , а также работаем в рамках 275 ФЗ с открытием отдельных счетов в уполномоченном банке. Система менеджмента качества компании соответствует требованиям ГОСТ ISO 9001.

Минимальные сроки поставки, гибкие цены, неограниченный ассортимент и индивидуальный подход к клиентам являются основой для выстраивания долгосрочного и эффективного сотрудничества с предприятиями радиоэлектронной промышленности, предприятиями ВПК и научно-исследовательскими институтами России.

С нами вы становитесь еще успешнее!

Наши контакты:

Телефон: +7 812 627 14 35

Электронная почта: sales@st-electron.ru

Адрес: 198099, Санкт-Петербург,
Промышленная ул, дом № 19, литера Н,
помещение 100-Н Офис 331