

Complete, Direct-Conversion Tuner for DVB-S and Free-to-Air Applications

General Description

The MAX2120 low-cost, direct-conversion tuner IC is designed for satellite set-top and VSAT applications. The IC is intended for QPSK, Digital Video Broadcast (DVB-S), DSS, and free-to-air applications.

The MAX2120 directly converts the satellite signals from the LNB to baseband using a broadband I/Q downconverter. The operating frequency range extends from 925MHz to 2175MHz.

The device includes an LNA and an RF variable-gain amplifier, I and Q downconverting mixers, and baseband lowpass filters with programmable cutoff frequency control and digitally controlled baseband variable-gain amplifiers. Together, the RF and baseband variable-gain amplifiers provide more than 80dB of gain-control range. The IC is compatible with virtually all QPSK demodulators.

The MAX2120 includes fully monolithic VCOs, as well as a complete frequency synthesizer. Additionally, an on-chip crystal oscillator is provided along with a buffered output for driving additional tuners and demodulators. Synthesizer programming and device configuration are accomplished with a 2-wire serial interface. The IC features a VCO autoselect (VAS) function that automatically selects the proper VCO. For multituner applications, the device can be configured to have one of two 2-wire interface addresses. A low-power standby mode is available whereupon the signal path is shut down while leaving the reference oscillator, digital interface, and buffer circuits active, providing a method to reduce power in single and multituner applications.

The MAX2120 is the most advanced DBS tuner available today. The low noise figure eliminates the need for an external LNA. A small number of passive components are needed to form a complete DVB, DBS, or VSAT RF front-end solution. The tuner is available in a very small 28-pin thin QFN package.

Applications

DirecTV and Dish Network DBS
DVB-S
Two-Way Satellite Systems
VSATs
Free-to-Air

Features

- ◆ 925MHz to 2175MHz Frequency Range
- ◆ Monolithic VCO: No Calibration Required
- ◆ -75dBm to 0dBm High Dynamic Range
- ◆ 4MHz to 40MHz Integrated Variable BW LP Filters
- ◆ Single +3.3V \pm 5% Supply
- ◆ Low-Power Standby Mode
- ◆ Address Pin for Multituner Applications
- ◆ Differential I/Q Interface
- ◆ I²C 2-Wire Serial Interface
- ◆ Very Small 28-Pin Thin QFN Package

Ordering Information

PART	TEMP RANGE	PIN-PACKAGE
MAX2120CTI+	0°C to +70°C	28 Thin QFN-EP*

*EP = Exposed paddle.

+Denotes a lead(Pb)-free/RoHS-compliant package.

Pin Configuration/ Functional Diagram

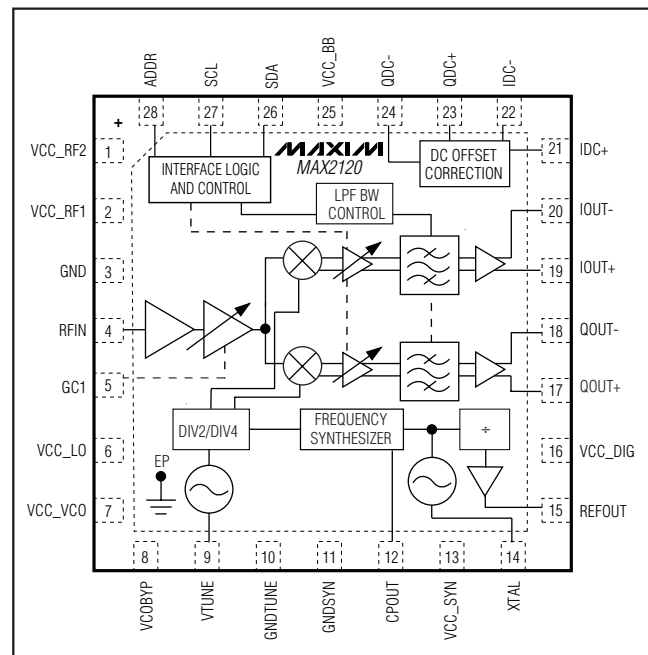

Complete, Direct-Conversion Tuner for DVB-S and Free-to-Air Applications

ABSOLUTE MAXIMUM RATINGS

V_{CC} to GND-0.3V to +3.9V
 All Other Pins to GND-0.3V to (V_{CC} + 0.3V)
 RF Input Power: RFIN+10dBm
 VCOBYP, CPOUT, REFOUT, XTAL, IOUT_, QOUT_, IDC_, and
 QDC_ Short-Circuit Protection.....10s

Continuous Power Dissipation (T_A = +70°C)
 28-Pin Thin QFN (derated 34.5mW/°C above +70°C).....2.75W
 Operating Temperature Range.....0°C to +70°C
 Junction Temperature+150°C
 Storage Temperature Range-65°C to +160°C
 Lead Temperature (soldering, 10s)+300°C
 Soldering Temperature (reflow)+260°C



Stresses beyond those listed under "Absolute Maximum Ratings" may cause permanent damage to the device. These are stress ratings only, and functional operation of the device at these or any other conditions beyond those indicated in the operational sections of the specifications is not implied. Exposure to absolute maximum rating conditions for extended periods may affect device reliability.

DC ELECTRICAL CHARACTERISTICS

(MAX2120 Evaluation Kit: V_{CC} = +3.13V to +3.47V, V_{GC1} = +0.5V (max gain), T_A = 0°C to +70°C. No input signals at RF, baseband I/Os are open circuited, and LO frequency = 2150MHz. Default register settings except BBG[3:0] = 1011. Typical values measured at V_{CC} = +3.3V, T_A = +25°C, unless otherwise noted.) (Note 1)

PARAMETER	CONDITIONS	MIN	TYP	MAX	UNITS
SUPPLY					
Supply Voltage		3.13	3.3	3.47	V
Supply Current	Receive mode, bit STBY = 0		100	160	mA
	Standby mode, bit STBY = 1		3		
ADDRESS SELECT INPUT (ADDR)					
Digital Input-Voltage High, V _{IH}		2.4			V
Digital Input-Voltage Low, V _{IL}				0.5	V
Digital Input-Current High, I _{IH}				50	μA
Digital Input-Current Low, I _{IL}		-50			μA
ANALOG GAIN-CONTROL INPUT (GC1)					
Input Voltage Range	Maximum gain = 0.5V	0.5		2.7	V
Input Bias Current		-50		+50	μA
VCO TUNING VOLTAGE INPUT (VTUNE)					
Input Voltage Range		0.4		2.3	V
2-WIRE SERIAL INPUTS (SCL, SDA)					
Clock Frequency				400	kHz
Input Logic-Level High		0.7 x V _{CC}			V
Input Logic-Level Low				0.3 x V _{CC}	V
Input Leakage Current	Digital inputs = GND or V _{CC}		±0.1	±1	μA
2-WIRE SERIAL OUTPUT (SDA)					
Output Logic-Level Low	I _{SINK} = 1mA			0.4	V

Complete, Direct-Conversion Tuner for DVB-S and Free-to-Air Applications

MAX2120

AC ELECTRICAL CHARACTERISTICS

(MAX2120 Evaluation Kit: $V_{CC} = +3.13V$ to $+3.47V$, $V_{GC1} = +0.5V$ (max gain), $T_A = 0^\circ C$ to $+70^\circ C$. Default register settings except $BBG[3:0] = 1011$. Typical values measured at $V_{CC} = +3.3V$, $T_A = +25^\circ C$, unless otherwise noted.) (Note 1)

PARAMETER	CONDITIONS	MIN	TYP	MAX	UNITS
MAIN SIGNAL PATH PERFORMANCE					
Input Frequency Range	(Note 2)	925		2175	MHz
RF Gain-Control Range (GC1)	$0.5V < V_{GC1} < 2.7V$	65	73		dB
Baseband Gain-Control Range	Bits GC2 = 1111 to 0000	13	15		dB
In-Band Input IP3	(Note 3)		+2		dBm
Out-of-Band Input IP3	(Note 4)		+15		dBm
Input IP2	(Note 5)		+40		dBm
Adjacent Channel Protection	(Note 6)		25		dB
Noise Figure	V_{GC1} is set to 0.5V (maximum RF gain) and $BBG[3:0]$ is adjusted to give a 1V _{P-P} baseband output level for a -75dBm CW input tone at 1500MHz		8		dB
	Starting with the same $BBG[3:0]$ setting as above, V_{GC1} is adjusted to back off RF gain by 10dB (Note 7)		9	12	
Minimum RF Input Return Loss	$925MHz < f_{RF} < 2175MHz$, in 75 Ω system		12		dB
BASEBAND OUTPUT CHARACTERISTICS					
Nominal Output Voltage Swing	$R_{LOAD} = 2k\Omega/10pF$	0.5	1		V _{P-P}
I/Q Amplitude Imbalance	Measured at 500kHz; filter set to 22.27MHz			± 1	dB
I/Q Quadrature Phase Imbalance	Measured at 500kHz; filter set to 22.27MHz			3.5	Degrees
Single-Ended I/Q Output Impedance	Real Z_O , from 1MHz to 40MHz		30		Ω
Output 1dB Compression Voltage	Differential		3		V _{P-P}
Baseband Highpass -3dB Frequency Corner	47nF capacitors at IDC_, QDC_		400		Hz
BASEBAND LOWPASS FILTERS					
Filter Bandwidth Range		4		40	MHz
Rejection Ratio	At 2 x f _{-3dB}		39		dB
Group Delay	Up to 1dB bandwidth		37		ns
Ratio of In-Filter-Band to Out-of-Filter-Band Noise	$f_{INBAND} = 100Hz$ to 22.5MHz, $f_{OUTBAND} = 87.5MHz$ to 112.5MHz		25		dB
FREQUENCY SYNTHESIZER					
RF-Divider Frequency Range		925		2175	MHz
RF-Divider Range (N)		16		2175	
Reference-Divider Frequency Range		4		30	MHz
Reference-Divider Range (R)		1		31	
Phase-Detector Comparison Frequency		1		2	MHz

Complete, Direct-Conversion Tuner for DVB-S and Free-to-Air Applications

AC ELECTRICAL CHARACTERISTICS (continued)

(MAX2120 Evaluation Kit: $V_{CC} = +3.13V$ to $+3.47V$, $V_{GC1} = +0.5V$ (max gain), $T_A = 0^\circ C$ to $+70^\circ C$. Default register settings except $BBG[3:0] = 1011$. Typical values measured at $V_{CC} = +3.3V$, $T_A = +25^\circ C$, unless otherwise noted.) (Note 1)

PARAMETER	CONDITIONS	MIN	TYP	MAX	UNITS
VOLTAGE-CONTROLLED OSCILLATOR AND LO GENERATION					
Guaranteed LO Frequency Range	$T_A = 0^\circ C$ to $+70^\circ C$	925		2175	MHz
LO Phase Noise	$f_{OFFSET} = 10kHz$		-82		dBc/Hz
	$f_{OFFSET} = 100kHz$		-102		
	$f_{OFFSET} = 1MHz$		-122		
XTAL/REFERENCE OSCILLATOR INPUT AND OUTPUT BUFFER					
XTAL Oscillator Frequency Range	Parallel-resonance-mode crystal (Note 8)	4		8	MHz
Input Overdrive Level	AC-coupled sine wave input	0.5	1	2.0	V _{P-P}
XTAL Output-Buffer Divider Range		1		8	
XTAL Output Voltage Swing	4MHz to 30MHz, $C_{LOAD} = 10pF$	1	1.5	2	V _{P-P}
XTAL Output Duty Cycle			50		%

Note 1: Min/max values are production tested at $T_A = +70^\circ C$. Min/max limits at $T_A = 0^\circ C$ and $T_A = +25^\circ C$ are guaranteed by design and characterization.

Note 2: Gain-control range specifications met over this band.

Note 3: In-band IIP3 test conditions: GC1 set to provide the nominal baseband output drive when mixing down a -23dBm tone at 2175MHz to 5MHz baseband ($f_{LO} = 2170MHz$). Baseband gain is set to its default value ($BBG[3:0] = 1011$). Two tones at -26dBm each are applied at 2174MHz and 2175MHz. The IM3 tone at 3MHz is measured at baseband, but is referred to the RF input.

Note 4: Out-of-band IIP3 test conditions: GC1 set to provide nominal baseband output drive when mixing down a -23dBm tone at 2175MHz to 5MHz baseband ($f_{LO} = 2170MHz$). Baseband gain is set to its default value ($BBG[3:0] = 1011$). Two tones at -20dBm each are applied at 2070MHz and 1975MHz. The IM3 tone at 5MHz is measured at baseband, but is referred to the RF input.

Note 5: Input IP2 test conditions: GC1 set to provide nominal baseband output drive when mixing down a -23dBm tone at 2175MHz to 5MHz baseband ($f_{LO} = 2170MHz$). Baseband gain is set to its default value ($BBG[3:0] = 1011$). Two tones at -20dBm each are applied at 925MHz and 1250MHz. The IM2 tone at 5MHz is measured at baseband, but is referred to the RF input.

Note 6: Adjacent channel protection test conditions: GC1 is set to provide the nominal baseband output drive with a 2110MHz 27.5Mbaud signal at -55dBm. GC2 set for mid-scale. The test signal will be set for PR = 7/8 and SNR of -8.5dB. An adjacent channel at $\pm 40MHz$ is added at -25dBm. DVB-S BER performance of $2E-4$ will be maintained for the desired signal. GC2 may be adjusted for best performance.

Note 7: Guaranteed by design and characterization at $T_A = +25^\circ C$.

Note 8: See Table 14 for crystal ESR requirements.

Complete, Direct-Conversion Tuner for DVB-S and Free-to-Air Applications

Typical Operating Characteristics

(MAX2120 Evaluation Kit: $V_{CC} = +3.3V$, baseband output frequency = 5MHz; $V_{GC1} = 1.2V$; $T_A = +25^\circ C$. Default register settings except $BBG[3:0] = 1011$.)

MAX2120

SUPPLY CURRENT vs. SUPPLY VOLTAGE

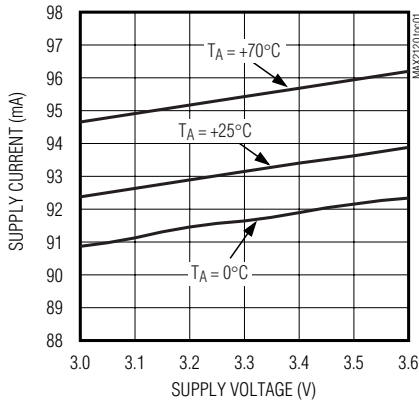

STANDBY MODE SUPPLY CURRENT vs. SUPPLY VOLTAGE

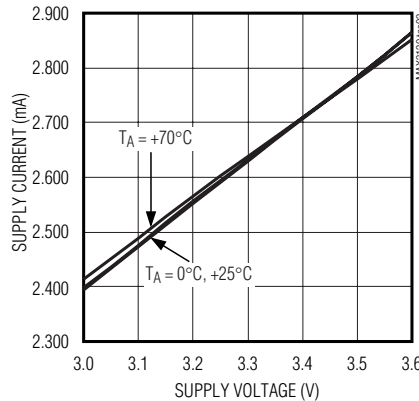

SUPPLY CURRENT vs. BASEBAND FILTER CUTOFF FREQUENCY

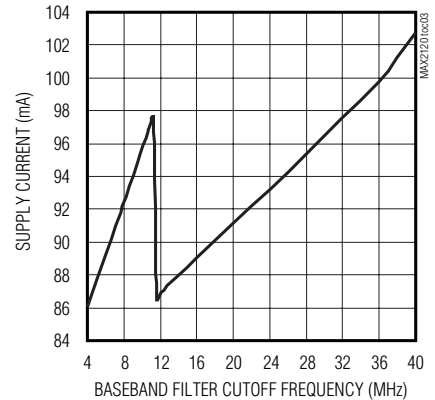

HD3 vs. OUTPUT VOLTAGE

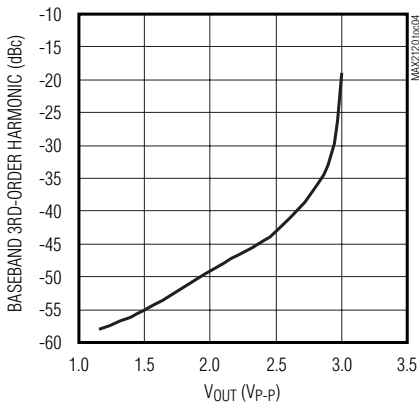

QUADRATURE PHASE vs. LO FREQUENCY

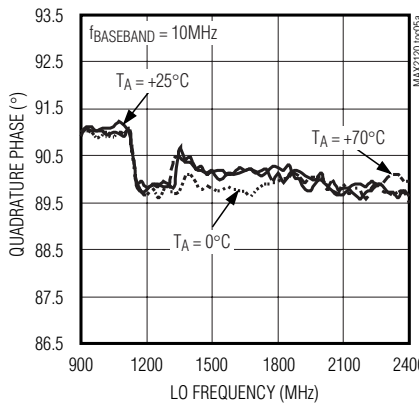

QUADRATURE MAGNITUDE MATCHING vs. LO FREQUENCY

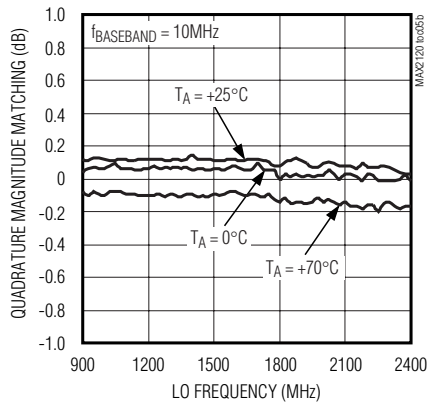

QUADRATURE PHASE vs. BASEBAND FREQUENCY

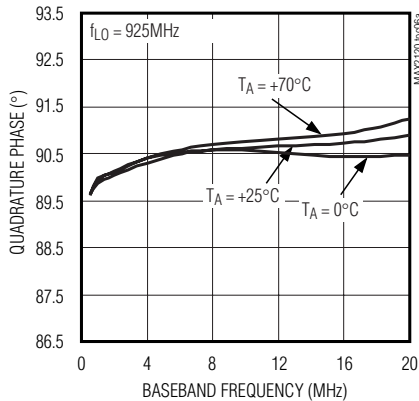

QUADRATURE MAGNITUDE MATCHING vs. BASEBAND FREQUENCY

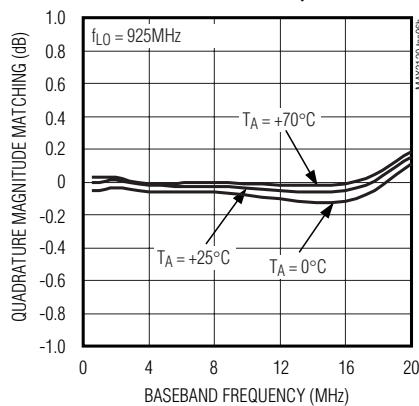

Complete, Direct-Conversion Tuner for DVB-S and Free-to-Air Applications

Typical Operating Characteristics (continued)

(MAX2120 Evaluation Kit: $V_{CC} = +3.3V$, baseband output frequency = 5MHz; $V_{GC1} = 1.2V$; $T_A = +25^\circ C$. Default register settings except $BBG[3:0] = 1011$.)

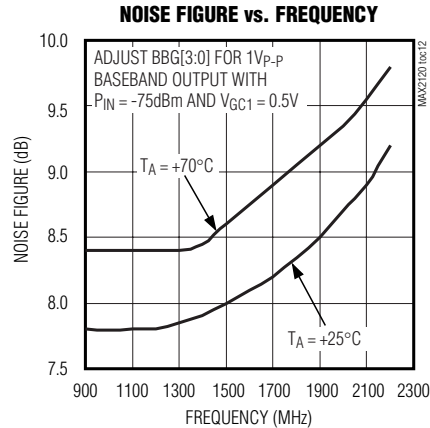
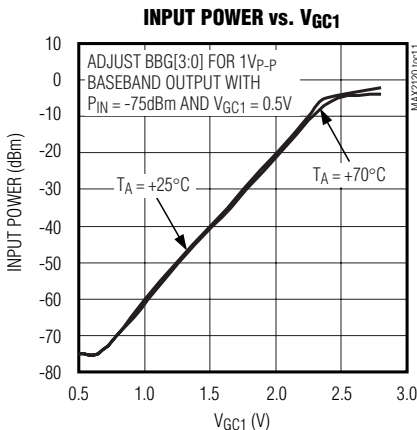
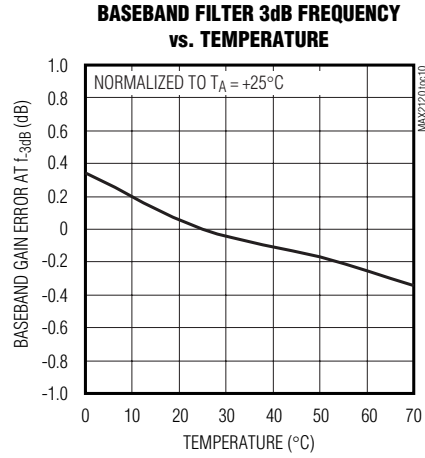
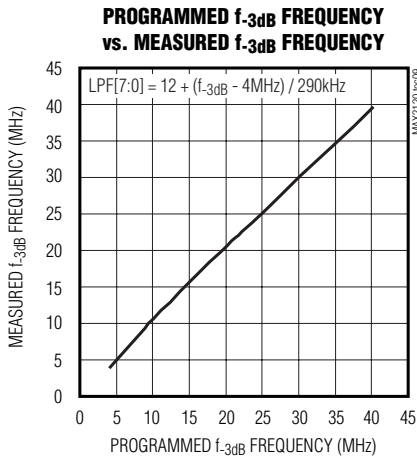
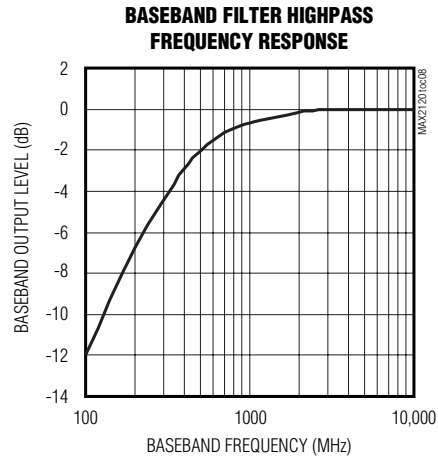
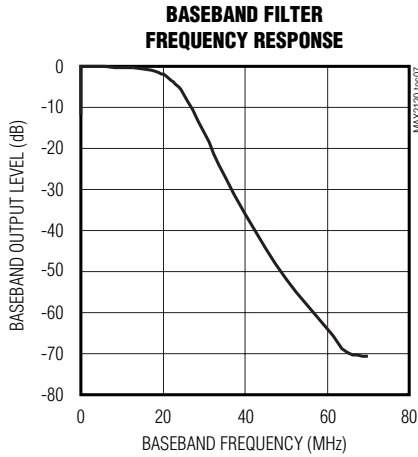

Complete, Direct-Conversion Tuner for DVB-S and Free-to-Air Applications

MAX2120

Typical Operating Characteristics (continued)

(MAX2120 Evaluation Kit: $V_{CC} = +3.3V$, baseband output frequency = 5MHz; $V_{GC1} = 1.2V$; $T_A = +25^{\circ}C$. Default register settings except $BBG[3:0] = 1011$.)

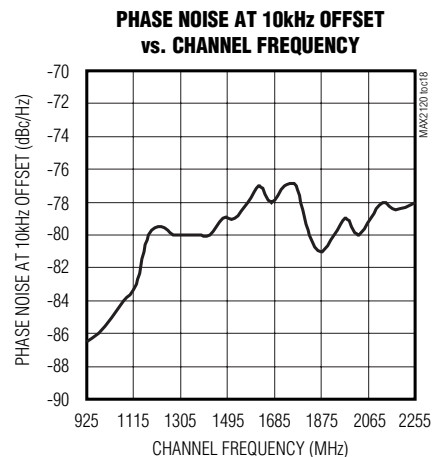
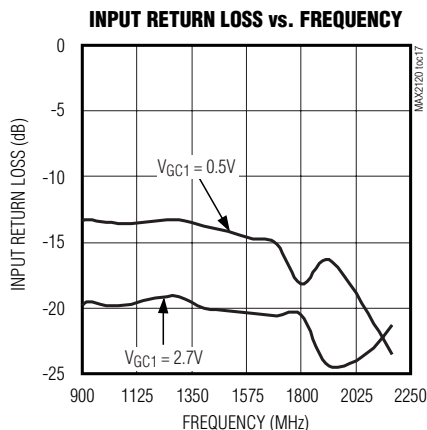
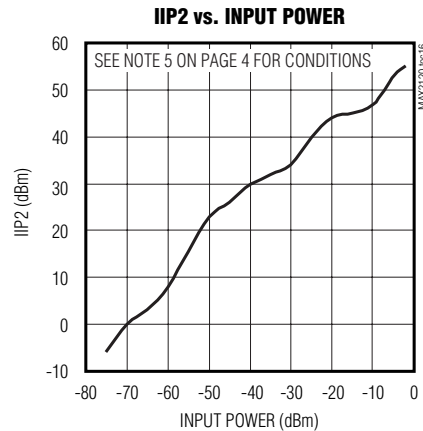
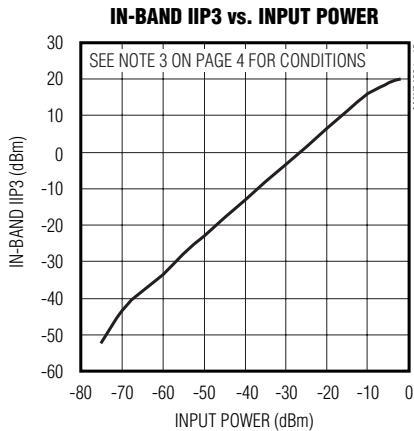
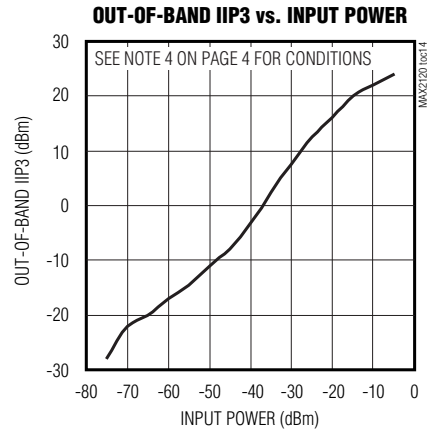
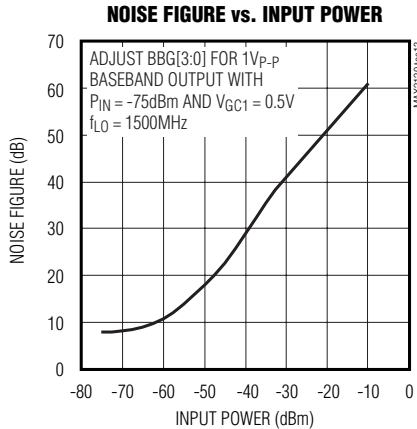

Complete, Direct-Conversion Tuner for DVB-S and Free-to-Air Applications

Typical Operating Characteristics (continued)

(MAX2120 Evaluation Kit: $V_{CC} = +3.3V$, baseband output frequency = 5MHz; $V_{GC1} = 1.2V$; $T_A = +25^{\circ}C$. Default register settings except $BBG[3:0] = 1011$.)

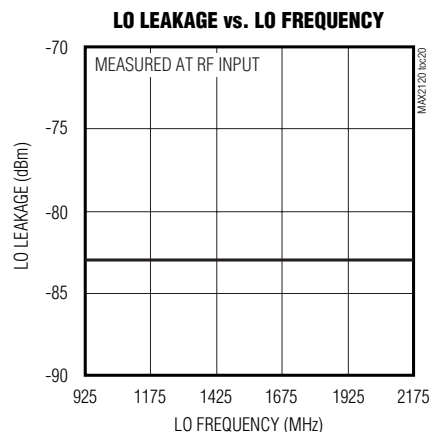
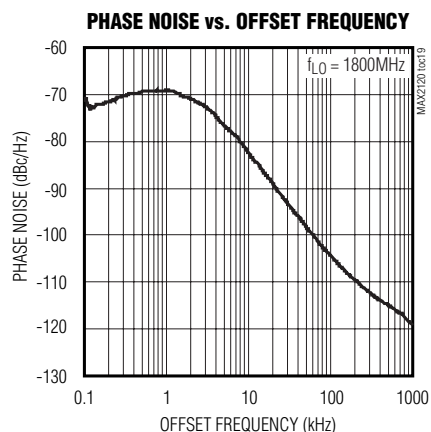

Pin Description

PIN	NAME	FUNCTION
1	VCC_RF2	DC Power Supply for LNA. Connect to a +3.3V low-noise supply. Bypass to GND with a 1nF capacitor connected as close as possible to the pin. Do not share capacitor ground vias with other ground connections.
2	VCC_RF1	DC Power Supply for LNA. Connect to a +3.3V low-noise supply. Bypass to GND with a 1nF capacitor connected as close as possible to the pin. Do not share capacitor ground vias with other ground connections.
3	GND	Ground. Connect to the board's ground plane for proper operation.
4	RFIN	Wideband 75Ω RF Input. Connect to an RF source through a DC-blocking capacitor.
5	GC1	RF Gain-Control Input. High-impedance analog input, with a 0.5V to 2.7V operating range. $V_{GC1} = 0.5V$ corresponds to the maximum gain setting.
6	VCC_LO	DC Power Supply for LO Generation Circuits. Connect to a +3.3V low-noise supply. Bypass to GND with a 1nF capacitor connected as close as possible to the pin. Do not share capacitor ground vias with other ground connections.
7	VCC_VCO	DC Power Supply for VCO Circuits. Connect to a +3.3V low-noise supply. Bypass to GND with a 1nF capacitor connected as close as possible to the pin. Do not share capacitor ground vias with other ground connections.
8	VCOBYP	Internal VCO Bias Bypass. Bypass to GND with a 100nF capacitor connected as close as possible to the pin. Do not share capacitor ground vias with other ground connections.
9	VTUNE	High-Impedance VCO Tune Input. Connect the PLL loop filter output directly to this pin with as short of a connection as possible.
10	GNDTUNE	Ground for VTUNE. Connect to the PCB ground plane.
11	GNDSYN	Ground for Synthesizer. Connect to the PCB ground plane.
12	CPOUT	Charge-Pump Output. Connect this output to the PLL loop filter input with the shortest connection possible.

Complete, Direct-Conversion Tuner for DVB-S and Free-to-Air Applications

Pin Description (continued)

MAX2120

PIN	NAME	FUNCTION
13	VCC_SYN	DC Power Supply for Synthesizer Circuits. Connect to a +3.3V low-noise supply. Bypass to GND with a 1nF capacitor connected as close as possible to the pin. Do not share capacitor ground vias with other ground connections.
14	XTAL	Crystal-Oscillator Interface. Use with an external parallel-resonance-mode crystal by a series 1nF capacitor. See the <i>Typical Operating Circuit</i> .
15	REFOUT	Crystal-Oscillator Buffer Output. A DC-blocking capacitor must be used when driving external circuitry.
16	VCC_DIG	DC Power Supply for Digital Logic Circuits. Connect to a +3.3V low-noise supply. Bypass to GND with a 1nF capacitor connected as close to the pin as possible. Do not share capacitor ground vias with other ground connections.
17	QOUT+	Quadrature Baseband Differential Output. AC-couple with a 47nF capacitor to the demodulator input.
18	QOUT-	
19	IOUT+	In-Phase Baseband Differential Output. AC-couple with a 47nF capacitor to the demodulator input.
20	IOUT-	
21	IDC+	I-Channel baseband DC Offset Correction. Connect a 47nF ceramic chip capacitor from IDC- to IDC+.
22	IDC-	
23	QDC+	Q-Channel Baseband DC Offset Correction. Connect a 47nF ceramic chip capacitor from QDC- to QDC+.
24	QDC-	
25	VCC_BB	DC Power Supply for Baseband Circuits. Connect to a +3.3V low-noise supply. Bypass to GND with a 1nF capacitor connected as close as possible to the pin. Do not share capacitor ground vias with other ground connections.
26	SDA	2-Wire Serial Data Interface. Requires a > 1k Ω pullup resistor to V _{CC} .
27	SCL	2-Wire Serial Clock Interface. Requires a > 1k Ω pullup resistor to V _{CC} .
28	ADDR	Address. ADDR is at logic-high if unconnected.
—	EP	Exposed Paddle. Solder evenly to the board's ground plane for proper operation.

Complete, Direct-Conversion Tuner for DVB-S and Free-to-Air Applications

Detailed Description

Register Description

The MAX2120 includes 12 user-programmable registers and 2 read-only registers. See Table 1 for register con-

figurations. The register configuration of Table 1 shows each bit name and the bit usage information for all registers. Note that all registers must be written after and no earlier than 100µs after the device is powered up.

Table 1. Register Configuration

REG NO	REGISTER NAME	READ/ WRITE	REG ADDRESS	MSB								LSB	
				DATA BYTE									
				D[7]	D[6]	D[5]	D[4]	D[3]	D[2]	D[1]	D[0]		
1	N-Divider MSB	Write	0x00	X	N[14]	N[13]	N[12]	N[11]	N[10]	N[9]	N[8]		
2	N-Divider LSB	Write	0x01	N[7]	N[6]	N[5]	N[4]	N[3]	N[2]	N[1]	N[0]		
3	Charge Pump	Write	0x02	CPMP[1] 0	CPMP[0] 0	CPLIN[1] 0	CPLIN[0] 0	X	X	X	X		
4	Not Used	Write	0x03	X	X	X	X	X	X	X	X		
5	Not Used	Write	0x04	X	X	X	X	X	X	X	X		
6	XTAL Divider/ R-Divider	Write	0x05	XD[2]	XD[1]	XD[0]	R[4]	R[3]	R[2]	R[1]	R[0]		
7	PLL	Write	0x06	D24	CPS	ICP	X	X	X	X	X		
8	VCO	Write	0x07	VCO[4]	VCO[3]	VCO[2]	VCO[1]	VCO[0]	VAS	ADL	ADE		
9	LPF	Write	0x08	LPF[7]	LPF[6]	LPF[5]	LPF[4]	LPF[3]	LPF[2]	LPF[1]	LPF[0]		
10	Control	Write	0x09	STBY	X	PWDN 0	X	BBG[3]	BBG[2]	BBG[1]	BBG[0]		
11	Shutdown	Write	0x0A	X	PLL 0	DIV 0	VCO 0	BB 0	RFMIX 0	RFVGA 0	FE 0		
12	Test	Write	0x0B	CPTST[2] 0	CPTST[1] 0	CPTST[0] 0	X	TURBO 1	LD MUX[2] 0	LD MUX[1] 0	LD MUX[0] 0		
13	Status Byte-1	Read	0x0C	POR	VASA	VASE	LD	X	X	X	X		
14	Status Byte-2	Read	0x0D	VCOSBR[4]	VCOSBR[3]	VCOSBR[2]	VCOSBR[1]	VCOSBR[0]	ADC[2]	ADC[1]	ADC[0]		

0 = Set to "0" for factory-tested operation.
1 = Set to "1" for factory-tested operation.
X = Don't care.

Table 2. N-Divider MSB Register

BIT NAME	BIT LOCATION (0 = LSB)	DEFAULT	FUNCTION
X	7	X	Don't care.
N[14:8]	6-0	0000011	Sets the most significant bits of the PLL integer-divide number (N). Default value is N = 950 decimal. N can range from 16 to 2175.

Table 3. N-Divider LSB Register

BIT NAME	BIT LOCATION (0 = LSB)	DEFAULT	FUNCTION
N[7:0]	7-0	10110110	Sets the least significant bits of the PLL integer-divide number (N). Default value is N = 950 decimal. N can range from 16 to 2175.

Complete, Direct-Conversion Tuner for DVB-S and Free-to-Air Applications

MAX2120

Table 4. Charge-Pump Register

BIT NAME	BIT LOCATION (0 = LSB)	DEFAULT	FUNCTION
CPMP[1:0]	7, 6	00	Charge-pump minimum pulse width. Users must program to 00 upon powering up the device.
CPLIN[1:0]	5, 4	00	Controls charge-pump linearity. 00 = Typically balanced charge and sink currents. Other values are not tested.
X	3-0	X	Don't care.

Table 5. XTAL Buffer and Reference Divider Register

BIT NAME	BIT LOCATION (0 = LSB)	DEFAULT	FUNCTION
XD[2:0]	7, 6, 5	000	Sets the crystal-divider setting. 000 = Divide by 1 (default) 001 = Divide by 2 011 = Divide by 3 100 = Divide by 4 101 through 110 = All divide values from 5 (101) to 7 (110) 111 = Divide by 8
R[4:0]	4-0	00100	Sets the PLL reference-divider (R) number. 00001 = Divide by 1 00010 = Divide by 2 00011 = Divide by 3 00100 = Divide by 4 (default) 00101 through 11110 = All divide values from 3 (00101) to 29 (11110) 11111 = Divide by 31

Table 6. PLL Register

BIT NAME	BIT LOCATION (0 = LSB)	DEFAULT	FUNCTION
D24	7	1	VCO divider setting. 0 = Divide by 2. Use for LO frequencies $\geq 1125\text{MHz}$. 1 = Divide by 4. Use for LO frequencies $< 1125\text{MHz}$.
CPS	6	1	Charge-pump current mode. 0 = Charge-pump current controlled by ICP bit 1 = Charge-pump current controlled by VCO autoselect (VAS)
ICP	5	0	Charge-pump current. 0 = 600 μA typical 1 = 1200 μA typical
X	4-0	X	Don't care.

Complete, Direct-Conversion Tuner for DVB-S and Free-to-Air Applications

Table 7. VCO Register

BIT NAME	BIT LOCATION (0 = LSB)	DEFAULT	FUNCTION
VCO[4:0]	7-3	11001	Controls which VCO is activated when using manual VCO programming mode. This also serves as the starting point for the VCO autoselect mode.
VAS	2	1	VCO Autoselection (VAS) Circuit 0 = Disable VCO selection must be program through I ² C 1 = Enable VCO selection controlled by autoselection circuit
ADL	1	0	Enables or disables the VCO tuning voltage ADC latch when the VCO autoselect mode (VAS) is disabled. 0 = Disables the ADC latch 1 = Latches the ADC value
ADE	0	0	Enables or disables VCO tuning voltage ADC read when the VCO autoselect mode (VAS) is disabled. 0 = Disables ADC read 1 = Enables ADC read

Table 8. Lowpass Filter Register

BIT NAME	BIT LOCATION (0 = LSB)	DEFAULT	FUNCTION
LPF[7:0]	7-0	01001011	Sets the baseband lowpass filter 3dB corner frequency. 3dB corner frequency = 4MHz + (LPF[7:0] - 12) x 290kHz.

Table 9. Control Register

BIT NAME	BIT LOCATION (0 = LSB)	DEFAULT	FUNCTION
STBY	7	0	Software standby control. 0 = Normal operation 1 = Disables the signal path and frequency synthesizer, leaving only the 2-wire bus, crystal oscillator, XTALOUT buffer, and XTALOUT buffer divider active
X	6	X	Don't care.
PWDN	5	0	Factory use only. 0 = Normal operation; other value is not tested.
X	4	X	Don't care.
BBG[3:0]	3-0	0000	Baseband gain setting (1dB typical per step). 0000 = Minimum gain (0dB) ... 1111 = Maximum gain (15dB typical)

Complete, Direct-Conversion Tuner for DVB-S and Free-to-Air Applications

Table 10. Shutdown Register

BIT NAME	BIT LOCATION (0 = LSB)	DEFAULT	FUNCTION
X	7	X	Don't care.
PLL	6	0	PLL enable. 0 = Normal operation 1 = Shuts down the PLL. Value not tested.
DIV	5	0	Divider enable. 0 = Normal operation 1 = Shuts down the divider. Value not tested.
VCO	4	0	VCO enable. 0 = Normal operation 1 = Shuts down the VCO. Value not tested.
BB	3	0	Baseband enable. 0 = Normal operation 1 = Shuts down the baseband. Value not tested.
RFMIX	2	0	RF mixer enable. 0 = Normal operation 1 = Shuts down the RF mixer. Value not tested.
RFVGA	1	0	RF VGA enable. 0 = Normal operation 1 = Shuts down the RF VGA. Value not tested.
FE	0	0	RF front-end enable. 0 = Normal operation 1 = Shuts down the RF front-end. Value not tested.

Table 11. Test Register

BIT NAME	BIT LOCATION (0 = LSB)	DEFAULT	FUNCTION
CPTST[2:0]	7, 6, 5	000	Charge-pump test modes. 000 = Normal operation (default) 001 = Crystal translator ECL to CMOS path 100 = Both source and sink currents enabled 101 = Source current enabled 110 = Sink current enabled 111 = High impedance (both source and sink current disabled)
X	4	X	Don't care.
TURBO	3	0	Charge-pump fast lock. Users must program to 1 upon powering up the device.
LDMUX[2:0]	2, 1, 0	000	REFOUT output. 000 = Normal operation; other values are not tested

Complete, Direct-Conversion Tuner for DVB-S and Free-to-Air Applications

Table 12. Status Byte-1 Register

BIT NAME	BIT LOCATION (0 = LSB)	FUNCTION
POR	7	Power-on reset status. 0 = Chip status register has been read with a stop condition since last power-on 1 = Power-on reset (power cycle) has occurred, default values have been loaded in registers
VASA	6	Indicates whether VCO autoselection was successful. 0 = Indicates the autoselect function is disabled or unsuccessful VCO selection 1 = Indicates successful VCO autoselection
VASE	5	Status indicator for the autoselect function. 0 = Indicates the autoselect function is active 1 = Indicates the autoselect process is inactive
LD	4	PLL lock detector. TURBO bit must be programmed to 1 for valid LD reading. 0 = Unlocked 1 = Locked
X	3-0	Don't care.

Table 13. Status Byte-2 Register

BIT NAME	BIT LOCATION (0 = LSB)	FUNCTION
VCOSBR[4:0]	7-3	VCO band readback.
ADC[2:0]	2, 1, 0	VAS ADC output readback. 000 = Out of lock 001 = Locked 010 = VAS locked 101 = VAS locked 110 = Locked 111 = Out of lock

Complete, Direct-Conversion Tuner for DVB-S and Free-to-Air Applications

2-Wire Serial Interface

The MAX2120 uses a 2-wire I²C-compatible serial interface consisting of a serial data line (SDA) and a serial clock line (SCL). SDA and SCL facilitate bidirectional communication between the MAX2120 and the master at clock frequencies up to 400kHz. The master initiates a data transfer on the bus and generates the SCL signal to permit data transfer. The MAX2120 behaves as a slave device that transfers and receives data to and from the master. SDA and SCL must be pulled high with external pullup resistors (1k Ω or greater) for proper bus operation.

One bit is transferred during each SCL clock cycle. A minimum of nine clock cycles is required to transfer a byte in or out of the MAX2120 (8 bits and an ACK/NACK). The data on SDA must remain stable during the high period of the SCL clock pulse. Changes in SDA while SCL is high and stable are considered control signals (see the *START and STOP Conditions* section). Both SDA and SCL remain high when the bus is not busy. Pullup resistors should be referenced to the MAX2120's V_{CC}.

START and STOP Conditions

The master initiates a transmission with a START condition (S), which is a high-to-low transition on SDA while SCL is high. The master terminates a transmission with a STOP condition (P), which is a low-to-high transition on SDA while SCL is high.

Acknowledge and Not-Acknowledge Conditions

Data transfers are framed with an acknowledge bit (ACK) or a not-acknowledge bit (NACK). Both the master and the MAX2120 (slave) generate acknowledge bits. To generate an acknowledge, the receiving device must pull SDA low before the rising edge of the acknowledge-related clock pulse (ninth pulse) and keep it low during the high period of the clock pulse.

To generate a not-acknowledge condition, the receiver allows SDA to be pulled high before the rising edge of the acknowledge-related clock pulse, and leaves SDA high during the high period of the clock pulse. Monitoring the acknowledge bits allows for detection of unsuccessful data transfers. An unsuccessful data transfer happens if a receiving device is busy or if a system fault has occurred. In the event of an unsuccessful data transfer, the bus master must reattempt communication at a later time.

Slave Address

The MAX2120 has a 7-bit slave address that must be sent to the device following a START condition to initiate communication. The slave address is internally programmed to 1100000. The eighth bit (R/W) following the 7-bit address determines whether a read or write operation will occur.

The MAX2120 continuously awaits a START condition followed by its slave address. When the device recognizes its slave address, it acknowledges by pulling the SDA line low for one clock period; it is ready to accept or send data depending on the R/W bit (Figure 1).

The write/read address is C0/C1 if the ADDR pin is connected to ground. The write/read address is C2/C3 if the ADDR pin is connected to V_{CC}.

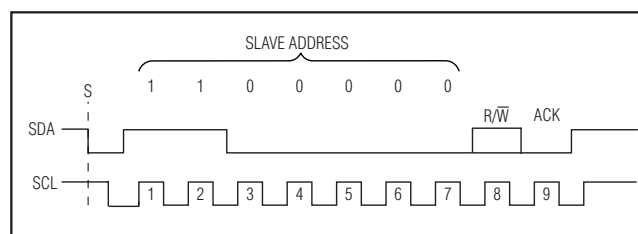

Figure 1. MAX2120 Slave Address Byte with ADDR Pin Connected to Ground

Write Cycle

When addressed with a write command, the MAX2120 allows the master to write to a single register or to multiple successive registers.

A write cycle begins with the bus master issuing a START condition followed by the seven slave address bits and a write bit (R/W = 0). The MAX2120 issues an ACK if the slave address byte is successfully received. The bus master must then send to the slave the address of the first register it wishes to write to (see Table 1 for register addresses). If the slave acknowledges the address, the master can then write one byte to the register at the specified address. Data is written beginning with the most significant bit. The MAX2120 again issues an ACK if the data is successfully written to the register. The master can continue to write data to the successive internal registers with the MAX2120 acknowledging each successful transfer, or it can terminate transmission by issuing a STOP condition. The write cycle will not terminate until the master issues a STOP condition.

Complete, Direct-Conversion Tuner for DVB-S and Free-to-Air Applications

Figure 2 illustrates an example in which registers 0 through 2 are written with 0x0E, 0xD8, and 0xE1, respectively.

Read Cycle

When addressed with a read command, the MAX2120 allows the master to read back a single register, or multiple successive registers.

A read cycle begins with the bus master issuing a START condition followed by the 7 slave address bits and a write bit ($R/\bar{W} = 0$). The MAX2120 issues an ACK if the slave address byte is successfully received. The bus master must then send the address of the first register it

wishes to read (see Table 1 for register addresses). The slave acknowledges the address. Then, a START condition is issued by the master, followed by the 7 slave address bits and a read bit ($R/\bar{W} = 1$). The MAX2120 issues an ACK if the slave address byte is successfully received. The MAX2120 starts sending data MSB first with each SCL clock cycle. At the 9th clock cycle, the master can issue an ACK and continue to read successive registers, or the master can terminate the transmission by issuing a NACK. The read cycle does not terminate until the master issues a STOP condition.

Figure 3 illustrates an example in which registers 0 through 2 are read back.

START	WRITE DEVICE ADDRESS	R/\bar{W}	ACK	WRITE REGISTER ADDRESS	ACK	WRITE DATA TO REGISTER 0x00	ACK	WRITE DATA TO REGISTER 0x01	ACK	WRITE DATA TO REGISTER 0x02	ACK	STOP
	1100000	0	—	0x00	—	0x0E	—	0xD8	—	0x0E1	—	

Figure 2. Example: Write Registers 0 through 2 with 0x0E, 0xD8, and 0xE1, respectively.

S T A R T	DEVICE ADDRESS	R/\bar{W}	A C K	REGISTER ADDRESS	A C K	S T A R T	DEVICE ADDRESS	R/\bar{W}	A C K	REG 00 DATA	A C K	REG 01 DATA	A C K	REG 02 DATA	N A C K	S T O P
	1100000	0		00000000			1100000	1		xxxxxxx		xxxxxxx		xxxxxxx		

Figure 3. Example: Receive data from read registers.

Complete, Direct-Conversion Tuner for DVB-S and Free-to-Air Applications

Applications Information

The MAX2120 downconverts RF signals in the 925MHz to 2175MHz range directly to the baseband I/Q signals. The devices are targeted for digital DBS tuner applications.

RF Input

The RF input of the MAX2120 is internally matched to 75Ω. Only a DC-blocking capacitor is needed. See the *Typical Operating Circuit*.

RF Gain Control

The MAX2120 features a variable-gain low-noise amplifier providing 73dB of RF gain range. The voltage-control (VGC) range is 0.5V (minimum attenuation) to 2.7V (maximum attenuation).

Baseband Variable-Gain Amplifier

The receiver baseband variable-gain amplifiers provide 15dB of gain-control range programmable in 1dB steps. The VGA gain can be serially programmed through the SPI™ interface by setting bits BBG[3:0] in the Control register.

Baseband Lowpass Filter

The MAX2120 includes a programmable on-chip 7th-order Butterworth filter. The -3dB corner frequency of the baseband filter is programmable by setting the bits LPF[7:0] in the Lowpass register. The value of the LPF[7:0] is determined by the following equation:

$$\text{LPF}[7:0]_{\text{dec}} = \frac{(f_{-3\text{dB}} - 4\text{MHz})}{0.29\text{MHz}} + 12,$$

where $f_{-3\text{dB}}$ is in units of MHz.

The filter can be adjusted from approximately 4MHz to 40MHz. Total device supply current depends on the filter BW setting, with increasing current commensurate with increasing -3dB BW.

DC Offset Cancellation

The DC offset cancellation is required to maintain the I/Q output dynamic range. Connecting an external capacitor between IDC+ and IDC- forms a highpass filter for the I channel, and an external capacitor between QDC+ and QDC- forms a highpass filter for the Q channel. Keep the value of the external capacitor less than 47nF to form a typical highpass corner of 400Hz.

XTAL Oscillator

The MAX2120 contains an internal reference oscillator, reference output divider, and output buffer. All that is required is to connect a crystal through a series, 1nF capacitor. To minimize parasitics, place the crystal and series capacitor as close as possible to pin 14 (XTAL pin). See Table 14 for crystal (XTAL) ESR (equivalent series resistance) requirements. The typical input capacitance is 40pF.

VCO Autoselect (VAS)

The MAX2120 includes 24 VCOs. The local oscillator frequency can be manually selected by programming the VCO[4:0] bits in the VCO register. The selected VCO is reported in the Status Byte-2 register (see Table 13).

Alternatively, the MAX2120 can be set to autonomously choose a VCO by setting the VAS bit in the VCO register to logic-high. The VAS routine is initiated once the N-divider LSB register word (REG 2) is loaded.

In the event that only the R-divider register or N-divider MSB register word is changed, the N-divider LSB word must also be loaded last to initiate the VCO autoselect function. The VCO value programmed in the VCO[4:0] register serves as the starting point for the automatic VCO selection process.

During the selection process, the VASE bit in the Status Byte-1 register is cleared to indicate the autoselection function is active. Upon successful completion, bits VASE and VASA are set and the VCO selected is reported in the Status Byte-2 register (see Table 13). If the search is unsuccessful, VASA is cleared and VASE is set. This indicates that searching has ended but no good VCO has been found, and occurs when trying to tune to a frequency outside the VCO's specified frequency range.

Refer to the MAX2112/MAX2120 VAS application note for more information.

Table 14. Maximum Crystal ESR Requirements

ESR _{MAX} (Ω)	XTAL FREQUENCY (MHz)
150	4 < f _{XTAL} ≤ 6
100	6 < f _{XTAL} ≤ 8
40	8 < f _{XTAL} ≤ 13.5

SPI is a trademark of Motorola, Inc.

Complete, Direct-Conversion Tuner for DVB-S and Free-to-Air Applications

3-Bit ADC

The MAX2120 has an internal 3-bit ADC connected to the VCO tune pin (VTUNE). This ADC can be used for checking the lock status of the VCOs.

Table 15 summarizes the ADC trip points, and the VCO lock indication. The VCO autoselect routine will only select a VCO in the “VAS locked” range. This allows room for a VCO to drift over temperature and remain in a valid “locked” range.

The ADC must first be enabled by setting the ADE bit in the VCO register. The ADC reading is latched by a subsequent programming of the ADC latch bit (ADL = 1). The ADC value is reported in the Status Byte-2 register (see Table 13).

Table 15. ADC Trip Points and Lock Status

ADC[2:0]	LOCK STATUS
000	Out of Lock
001	Locked
010	VAS Locked
101	VAS Locked
110	Locked
111	Out of Lock

Standby Mode

The MAX2120 features normal operating mode and standby mode using the I²C interface. Setting a logic-high to the PWDN bit in the Control register enables power-down. In this mode, all circuitries except for the 2-wire-compatible bus are disabled, allowing for programming of the MAX2120 registers while in power-down.

In all cases, register settings loaded prior to entering shutdown are saved upon transition back to active mode. Default register values are provided for the user's convenience only. It's the user's responsibility to load all the registers no sooner than 100µs after the device is powered up.

Layout Considerations

The MAX2120 EV kit serves as a guide for PCB layout. Keep RF signal lines as short as possible to minimize losses and radiation. Use controlled impedance on all high-frequency traces. For proper operation, the exposed paddle must be soldered evenly to the board's ground plane. Use abundant vias beneath the exposed paddle for maximum heat dissipation. Use abundant ground vias between RF traces to minimize undesired coupling. Bypass each VCC pin to ground with a 1nF capacitor placed as close as possible to the pin.

Complete, Direct-Conversion Tuner for DVB-S and Free-to-Air Applications

Typical Operating Circuit

MAX2120

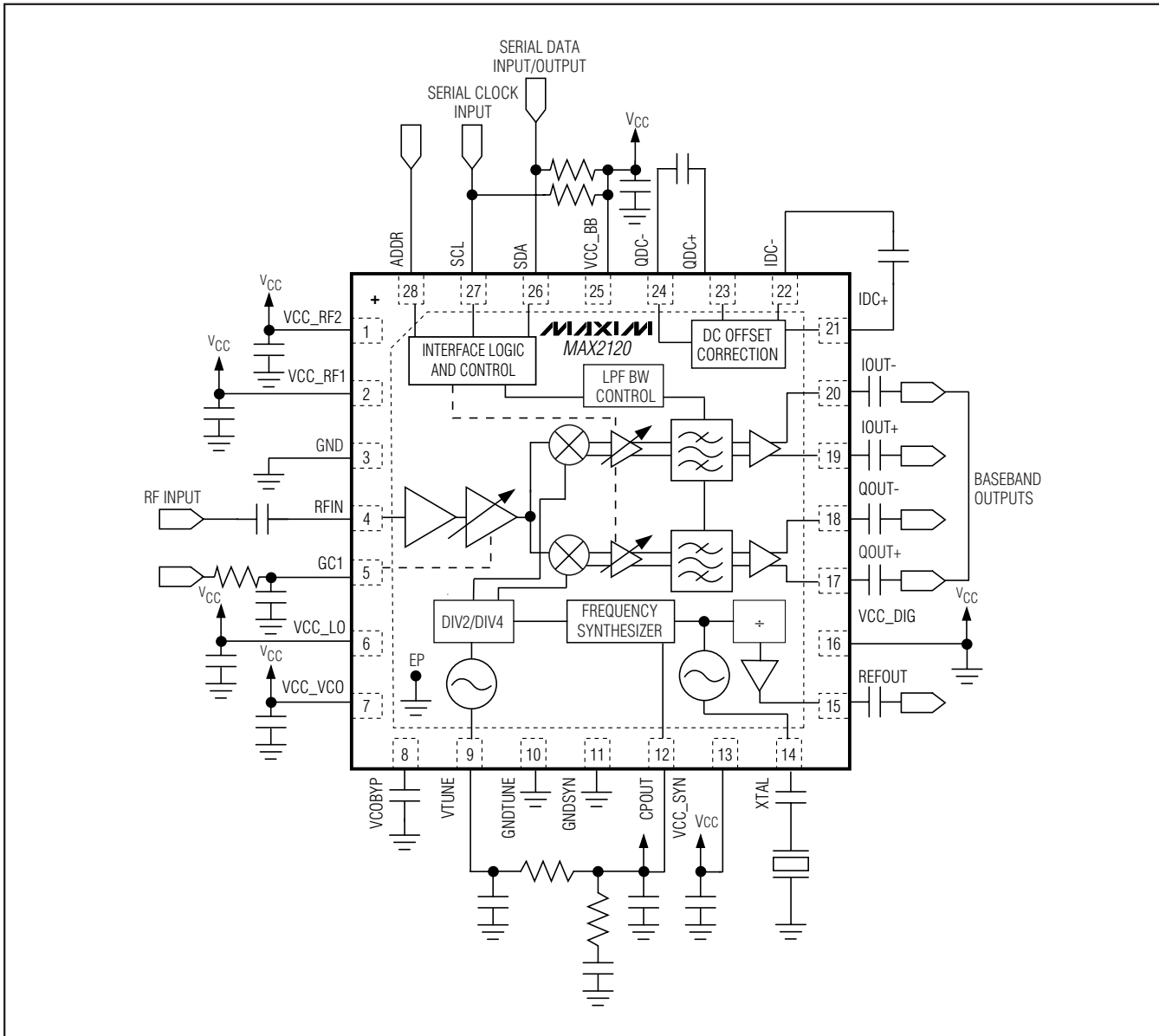

Complete, Direct-Conversion Tuner for DVB-S and Free-to-Air Applications

Chip Information

PROCESS: BiCMOS

Package Information

For the latest package outline information and land patterns, go to www.maxim-ic.com/packages. Note that a "+", "#", or "-" in the package code indicates RoHS status only. Package drawings may show a different suffix character, but the drawing pertains to the package regardless of RoHS status.

PACKAGE TYPE	PACKAGE CODE	OUTLINE NO.	LAND PATTERN NO.
28 TQFN	T2855+3	21-0140	90-0023

Complete, Direct-Conversion Tuner for DVB-S and Free-to-Air Applications

Revision History

REVISION NUMBER	REVISION DATE	DESCRIPTION	PAGES CHANGED
0	6/07	Initial release	—
1	3/08	Corrected errors in data sheet, replaced <i>Read Cycle</i> section and Figure 3, added Table 14	1–18
2	5/10	Corrected D24 bit Function in Table 6	11

MAX2120

Maxim cannot assume responsibility for use of any circuitry other than circuitry entirely embodied in a Maxim product. No circuit patent licenses are implied. Maxim reserves the right to change the circuitry and specifications without notice at any time.

Maxim Integrated Products, 120 San Gabriel Drive, Sunnyvale, CA 94086 408-737-7600 _____ 21



Стандарт Электрон Связь

Мы молодая и активно развивающаяся компания в области поставок электронных компонентов. Мы поставляем электронные компоненты отечественного и импортного производства напрямую от производителей и с крупнейших складов мира.

Благодаря сотрудничеству с мировыми поставщиками мы осуществляем комплексные и плановые поставки широчайшего спектра электронных компонентов.

Собственная эффективная логистика и склад в обеспечивает надежную поставку продукции в точно указанные сроки по всей России.

Мы осуществляем техническую поддержку нашим клиентам и предпродажную проверку качества продукции. На все поставляемые продукты мы предоставляем гарантию .

Осуществляем поставки продукции под контролем ВП МО РФ на предприятия военно-промышленного комплекса России , а также работаем в рамках 275 ФЗ с открытием отдельных счетов в уполномоченном банке. Система менеджмента качества компании соответствует требованиям ГОСТ ISO 9001.

Минимальные сроки поставки, гибкие цены, неограниченный ассортимент и индивидуальный подход к клиентам являются основой для выстраивания долгосрочного и эффективного сотрудничества с предприятиями радиоэлектронной промышленности, предприятиями ВПК и научно-исследовательскими институтами России.

С нами вы становитесь еще успешнее!

Наши контакты:

Телефон: +7 812 627 14 35

Электронная почта: sales@st-electron.ru

Адрес: 198099, Санкт-Петербург,
Промышленная ул, дом № 19, литера Н,
помещение 100-Н Офис 331