

Description

The 74LVC2G34 is a dual buffer gate with standard push - pull outputs. The device is designed for operation with a power supply range of 1.65V to 5.5V. The inputs are tolerant to 5.5V allowing this device to be used in a mixed voltage environment. The device is fully specified for partial power down applications using I_{OFF}. The I_{OFF} circuitry disables the output preventing damaging current backflow when the device is powered down.

The gate performs the positive Boolean function:

$$Y = A$$

Pin Assignments

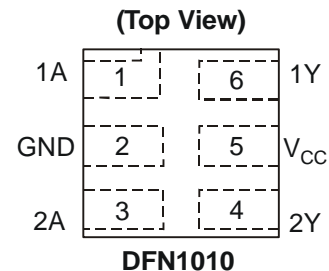
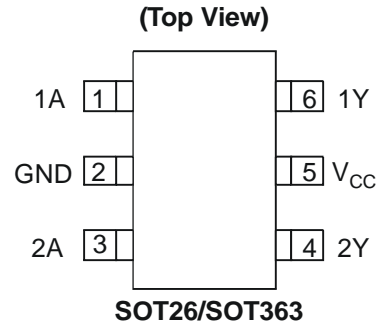

Features

- Wide Supply Voltage Range from 1.65V to 5.5V
- ±24mA Output Drive at 3.0V
- CMOS low power consumption
- IOFF Supports Partial-Power-Down Mode Operation
- Inputs accept up to 5.5V
- ESD Protection Tested per JESD 22
 - Exceeds 200-V Machine Model (A115-A)
 - Exceeds 2000-V Human Body Model (A114-A)
 - Exceeds 1000-V Charged Device Model (C101)
- Latch-Up Exceeds 100mA per JESD 78, Class II
- Range of Package Options
- SOT26, SOT363, and DFN1010 Available in “Green” Molding Compound (no Br, Sb)
- Lead Free Finish/ RoHS Compliant (Note 1)

Applications

- Voltage Level Shifting
- General Purpose Logic
- Power Down Signal Isolation
- Wide array of products such as:
 - PCs, networking, notebooks, netbooks, PDAs
 - Computer peripherals, hard drives, CD/DVD ROM
 - TV, DVD, DVR, set top box
 - Cell Phones, Personal Navigation / GPS
 - MP3 players ,Cameras, Video Recorders

Notes: 1. EU Directive 2002/95/EC (RoHS). All applicable RoHS exemptions applied. Please visit our website at http://www.diodes.com/products/lead_free.html.

Pin Descriptions

Pin Name	Pin NO.	Description
1A	1	Data Input
GND	2	Ground
2A	3	Data Input
2Y	4	Data Output
V _{CC}	5	Supply Voltage
1Y	6	Data Output

Logic Diagram

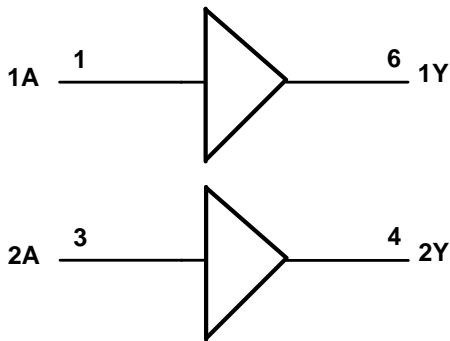

Function Table

Inputs	Output
A	Y
H	H
L	L

Absolute Maximum Ratings (Note 2)

Symbol	Description	Rating	Unit
ESD HBM	Human Body Model ESD Protection	2	KV
ESD CDM	Charged Device Model ESD Protection	1	KV
ESD MM	Machine Model ESD Protection	200	V
V _{CC}	Supply Voltage Range	-0.5 to 6.5	V
V _I	Input Voltage Range	-0.5 to 6.5	V
V _O	Voltage applied to output in high impedance or I _{OFF} state	-0.5 to 6.5	V
V _O	Voltage applied to output in high or low state.	-0.3 to V _{CC} +0.5	V
I _{IK}	Input Clamp Current V _I <0	-50	mA
I _{OK}	Output Clamp Current	-50	mA
I _O	Continuous output current	±50	mA
	Continuous current through V _{DD} or GND	±100	mA
T _J	Operating Junction Temperature	-40 to 150	°C
T _{STG}	Storage Temperature	-65 to 150	°C

Notes: 2. Stresses beyond the absolute maximum may result in immediate failure or reduced reliability. These are stress values and device operation should be within recommend values.

Recommended Operating Conditions (Note 3)

Symbol	Parameter	Min	Max	Unit	
V _{CC}	Operating Voltage	Operating	1.65	5.5	V
		Data retention only	1.5		V
V _{IH}	High-level Input Voltage	V _{CC} = 1.65V to 1.95V	0.65 X V _{CC}		V
		V _{CC} = 2.3V to 2.7V	1.7		
		V _{CC} = 3V to 3.6V	2		
		V _{CC} = 4.5V to 5.5V	0.7 X V _{CC}		
V _{IL}	Low-level input voltage	V _{CC} = 1.65V to 1.95V		0.35 X V _{CC}	V
		V _{CC} = 2.3V to 2.7V		0.7	
		V _{CC} = 3V to 3.6V		0.8	
		V _{CC} = 4.5V to 5.5V		0.3 X V _{CC}	
V _I	Input Voltage	0	5.5	V	
V _O	Output Voltage	0	V _{CC}	V	
I _{OH}	High-level output current	V _{CC} = 1.65V		-4	mA
		V _{CC} = 2.3V		-8	
		V _{CC} = 3V		-16	
		V _{CC} = 4.5V		-24	
I _{OL}	Low-level output current	V _{CC} = 1.65V		4	mA
		V _{CC} = 2.3V		8	
		V _{CC} = 3V		16	
		V _{CC} = 4.5V		24	
				32	

Recommended Operating Conditions (cont.) (Note 3)

Symbol	Parameter	Min	Max	Unit
$\Delta t/\Delta V$	Input transition rise or fall rate	$V_{CC} = 1.8V \pm 0.15V, 2.5V \pm 0.2V$		20
		$V_{CC} = 3.3V \pm 0.3V$		10
		$V_{CC} = 5V \pm 0.5V$		5
T_A	Operating free-air temperature	-40	125	$^{\circ}C$

Notes: 3. Unused inputs should be held at V_{CC} or Ground.

Electrical Characteristics

Symbol	Parameter	Test Conditions	V_{CC}	40 $^{\circ}C$ to 85 $^{\circ}C$		-40 $^{\circ}C$ to 125 $^{\circ}C$		Unit
				Min	Max	Min	Max	
V_{OH}	High Level Output Voltage	$I_{OH} = -100\mu A$	1.65V to 5.5V	$V_{CC} - 0.1$		$V_{CC} - 0.1$		V
		$I_{OH} = -4mA$	1.65V	1.2		0.95		
		$I_{OH} = -8mA$	2.3V	1.9		1.7		
		$I_{OH} = -16mA$	3V	2.4		1.9		
		$I_{OH} = -24mA$		2.3		2.0		
		$I_{OH} = -32mA$	4.5V	3.8		3.4		
V_{OL}	Low Level Output Voltage	$I_{OL} = 100\mu A$	1.65V to 5.5V		0.1		0.1	V
		$I_{OL} = 4mA$	1.65V		0.45		0.70	
		$I_{OL} = 8mA$	2.3V		0.3		0.45	
		$I_{OL} = 16mA$	3V		0.4		0.60	
		$I_{OL} = 24mA$			0.55		0.80	
		$I_{OL} = 32mA$	4.5V		0.55		0.80	
I_I	Input Current	$V_I = 5.5V$ or GND	0 to 5.5V		± 5		± 20	μA
I_{OFF}	Power Down Leakage Current	V_I or $V_O = 5.5V$	0		± 10		± 20	μA
I_{CC}	Supply Current	$V_I = 5.5V$ of GND $I_O = 0$	1.65V to 5.5V		10		40	μA
ΔI_{CC}	Additional Supply Current	Input at $V_{CC} - 0.6V$	3V to 5.5V		500		5000	μA

Package Characteristics (All typical values are at $V_{CC} = 3.3V$, $T_A = 25^\circ C$)

Symbol	Parameter	Test Conditions	V_{CC}	Min	Typ.	Max	Unit
C_I	Input Capacitance	$V_I = V_{CC} - \text{or GND}$	3.3		4		pF
θ_{JA}	Thermal Resistance Junction-to-Ambient	SOT26	(Note 4)		204		$^\circ C/W$
		SOT363			371		
		DFN1010			430		
θ_{JC}	Thermal Resistance Junction-to-Case	SOT26	(Note 4)		52		$^\circ C/W$
		SOT363			143		
		DFN1010			190		

Notes: 4. Test condition for SOT26, SOT363 and DFN1010 : Device mounted on FR-4 substrate PC board, 2oz copper, with minimum recommended pad layout.

Switching Characteristics

$T_A = -40^\circ C$ to $85^\circ C$, $CL = 30$ or $50pF$ (see Figure 1)

Parameter	From (Input)	TO (OUTPUT)	$V_{CC} = 1.8V \pm 0.15V$		$V_{CC} = 2.5V \pm 0.2V$		$V_{CC} = 3.3V \pm 0.3V$		$V_{CC} = 5V \pm 0.5V$		Unit
			Min	Max	Min	Max	Min	Max	Min	Max	
t_{pd}	A	Y	0.5	8.6	0.5	4.4	0.5	4.1	0.5	3.2	ns

$T_A = -40^\circ C$ to $125^\circ C$, $CL = 30$ or $50pF$ (see Figure 1)

Parameter	From (Input)	TO (OUTPUT)	$V_{CC} = 1.8V \pm 0.15V$		$V_{CC} = 2.5V \pm 0.2V$		$V_{CC} = 3.3V \pm 0.3V$		$V_{CC} = 5V \pm 0.5V$		Unit
			Min	Max	Min	Max	Min	Max	Min	Max	
t_{pd}	A	Y	0.5	10.8	0.5	5.5	0.5	5.1	0.5	4.0	ns

Operating Characteristics

$T_A = 25^\circ C$

Parameter		Test Conditions	$V_{CC} = 1.8V$	$V_{CC} = 2.5V$	$V_{CC} = 3.3V$	$V_{CC} = 5V$	Unit
			Typ.	Typ.	Typ.	Typ.	
C_{pd}	Power dissipation capacitance	$f = 10$ MHz	17	19	20	21	pF

Parameter Measurement Information

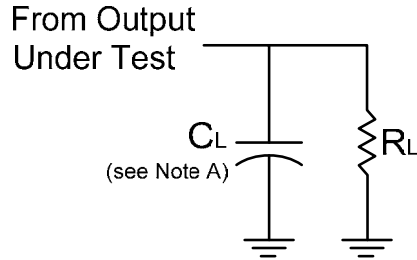

V_{CC}	Inputs		V_M	C_L	R_L
	V_I	t_r/t_f			
$1.8V \pm 0.15V$	V_{CC}	$\leq 2ns$	$V_{CC}/2$	30 pF	1 K Ω
$2.5V \pm 0.2V$	V_{CC}	$\leq 2ns$	$V_{CC}/2$	30 pF	500 Ω
$3.3V \pm 0.3V$	3 V	$\leq 2.5ns$	1.5 V	50 pF	500 Ω
$5V \pm 0.5V$	V_{CC}	$\leq 2.5ns$	$V_{CC}/2$	50 pF	500 Ω

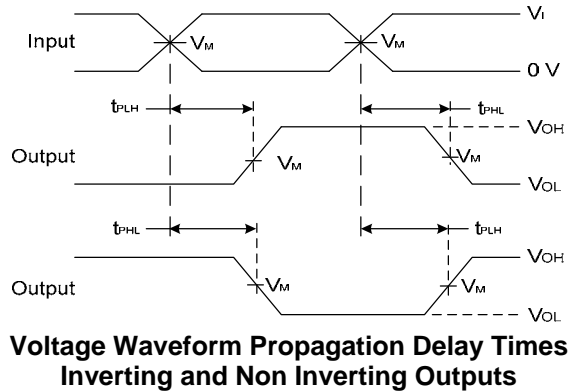
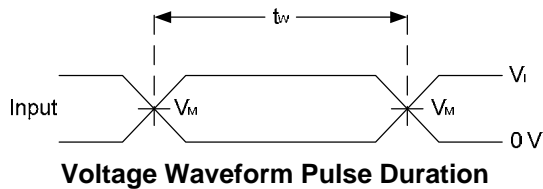
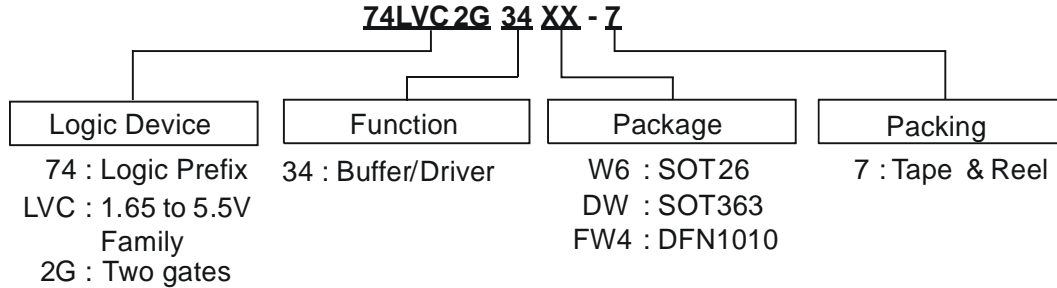

Figure 1. Load Circuit and Voltage Waveforms

- Notes:
- A. Includes test lead and test apparatus capacitance.
 - B. All pulses are supplied at pulse repetition rate ≤ 10 MHz.
 - C. Inputs are measured separately one transition per measurement.
 - D. t_{PLH} and t_{PHL} are the same as t_{PD} .

Ordering Information



Device	Package Code	Packaging (Note 5)	7" Tape and Reel	
			Quantity	Part Number Suffix
74LVC2G34W6-7	W6	SOT26	3000/Tape & Reel	-7
74LVC2G34DW-7	DW	SOT363	3000/Tape & Reel	-7
74LVC2G34FW4-7	FW4	DFN1010	5000/Tape & Reel	-7

Notes: 5. Pad layout as shown on Diodes Inc. suggested pad layout document AP02001, which can be found on our website at <http://www.diodes.com/datasheets/ap02001.pdf>
6. The taping orientation is located on our website at <http://www.diodes.com/datasheets/ap02007.pdf>

Marking Information

(1) SOT26, SOT363

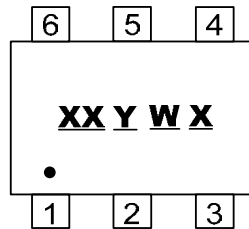

XX : Identification code
Y : Year 0~9
W : Week : A~Z : 1~26 week;
a~z : 27~52 week; z represents 52 and 53 week
X : A~Z : Internal Code

Part Number	Package	Identification Code
74LVC2G34W6	SOT26	Z7
74LVC2G34DW	SOT363	Z7

(2) DFN1010

(Top View)

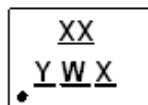

XX : Identification Code
Y : Year : 0~9
W : Week : A~Z : 1~26 week;
a~z : 27~52 week; z represents 52 and 53 week
X : A~Z : Internal code

Part Number	Package	Identification Code
74LVC2G34FW4	DFN1010	Z7

Package Outline Dimensions (All Dimensions in mm)

(1) Package Type: SOT26

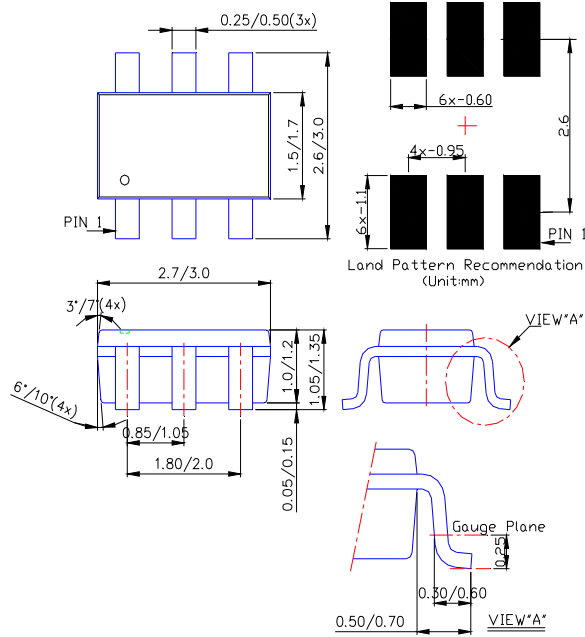

(2) Package Type: SOT363

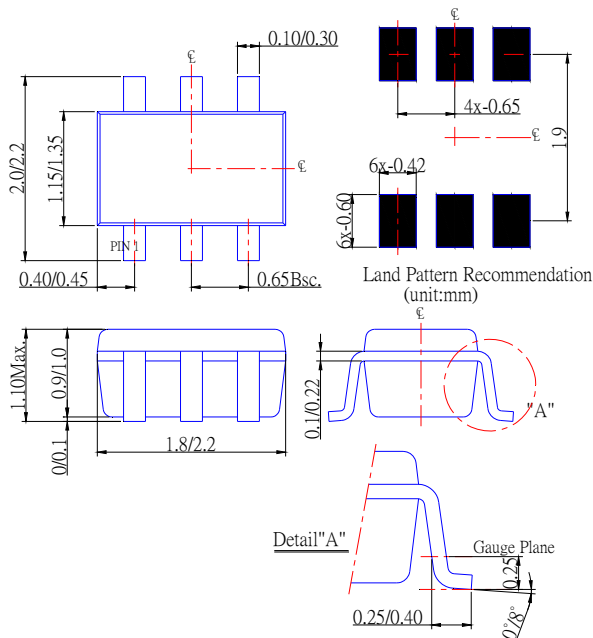

IMPORTANT NOTICE

DIODES INCORPORATED MAKES NO WARRANTY OF ANY KIND, EXPRESS OR IMPLIED, WITH REGARDS TO THIS DOCUMENT, INCLUDING, BUT NOT LIMITED TO, THE IMPLIED WARRANTIES OF MERCHANTABILITY AND FITNESS FOR A PARTICULAR PURPOSE (AND THEIR EQUIVALENTS UNDER THE LAWS OF ANY JURISDICTION).

Diodes Incorporated and its subsidiaries reserve the right to make modifications, enhancements, improvements, corrections or other changes without further notice to this document and any product described herein. Diodes Incorporated does not assume any liability arising out of the application or use of this document or any product described herein; neither does Diodes Incorporated convey any license under its patent or trademark rights, nor the rights of others. Any Customer or user of this document or products described herein in such applications shall assume all risks of such use and will agree to hold Diodes Incorporated and all the companies whose products are represented on Diodes Incorporated website, harmless against all damages.

Diodes Incorporated does not warrant or accept any liability whatsoever in respect of any products purchased through unauthorized sales channel.

Should Customers purchase or use Diodes Incorporated products for any unintended or unauthorized application, Customers shall indemnify and hold Diodes Incorporated and its representatives harmless against all claims, damages, expenses, and attorney fees arising out of, directly or indirectly, any claim of personal injury or death associated with such unintended or unauthorized application.

Products described herein may be covered by one or more United States, international or foreign patents pending. Product names and markings noted herein may also be covered by one or more United States, international or foreign trademarks.

LIFE SUPPORT

Diodes Incorporated products are specifically not authorized for use as critical components in life support devices or systems without the express written approval of the Chief Executive Officer of Diodes Incorporated. As used herein:

A. Life support devices or systems are devices or systems which:

1. are intended to implant into the body, or
2. support or sustain life and whose failure to perform when properly used in accordance with instructions for use provided in the labeling can be reasonably expected to result in significant injury to the user.

B. A critical component is any component in a life support device or system whose failure to perform can be reasonably expected to cause the failure of the life support device or to affect its safety or effectiveness.

Customers represent that they have all necessary expertise in the safety and regulatory ramifications of their life support devices or systems, and acknowledge and agree that they are solely responsible for all legal, regulatory and safety-related requirements concerning their products and any use of Diodes Incorporated products in such safety-critical, life support devices or systems, notwithstanding any devices- or systems-related information or support that may be provided by Diodes Incorporated. Further, Customers must fully indemnify Diodes Incorporated and its representatives against any damages arising out of the use of Diodes Incorporated products in such safety-critical, life support devices or systems.

Copyright © 2011, Diodes Incorporated

www.diodes.com



Стандарт Электрон Связь

Мы молодая и активно развивающаяся компания в области поставок электронных компонентов. Мы поставляем электронные компоненты отечественного и импортного производства напрямую от производителей и с крупнейших складов мира.

Благодаря сотрудничеству с мировыми поставщиками мы осуществляем комплексные и плановые поставки широчайшего спектра электронных компонентов.

Собственная эффективная логистика и склад в обеспечивает надежную поставку продукции в точно указанные сроки по всей России.

Мы осуществляем техническую поддержку нашим клиентам и предпродажную проверку качества продукции. На все поставляемые продукты мы предоставляем гарантию .

Осуществляем поставки продукции под контролем ВП МО РФ на предприятия военно-промышленного комплекса России , а также работаем в рамках 275 ФЗ с открытием отдельных счетов в уполномоченном банке. Система менеджмента качества компании соответствует требованиям ГОСТ ISO 9001.

Минимальные сроки поставки, гибкие цены, неограниченный ассортимент и индивидуальный подход к клиентам являются основой для выстраивания долгосрочного и эффективного сотрудничества с предприятиями радиоэлектронной промышленности, предприятиями ВПК и научно-исследовательскими институтами России.

С нами вы становитесь еще успешнее!

Наши контакты:

Телефон: +7 812 627 14 35

Электронная почта: sales@st-electron.ru

Адрес: 198099, Санкт-Петербург,
Промышленная ул, дом № 19, литера Н,
помещение 100-Н Офис 331