

# Power Panel Potentiometer



## FEATURES

- High power rating (6 W at 50 °C)
- Cermet element
- Full sealing
- Mechanical strength
- Industrial and professional grade
- Tests according to CECC 41 000



RoHS  
COMPLIANT

## DIMENSIONS in millimeters

### PE 60 L

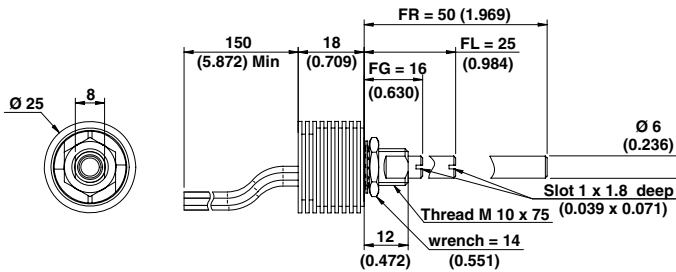

### PE 60 F

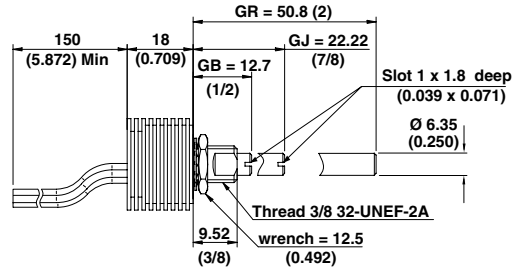

### OPTION D: DBAN SHAFT LOCKING

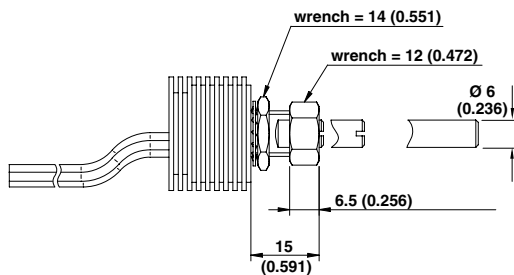

Available only with PE 60 L

### OPTION L: PE 60 LPRP - WITH LOCATING PEG

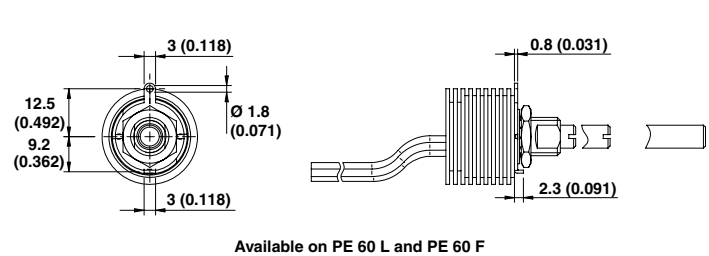

Available on PE 60 L and PE 60 F

## Panel sealed version

### PE 60 M

### OPTION E: Including locating peg (available only for PE 60 M)

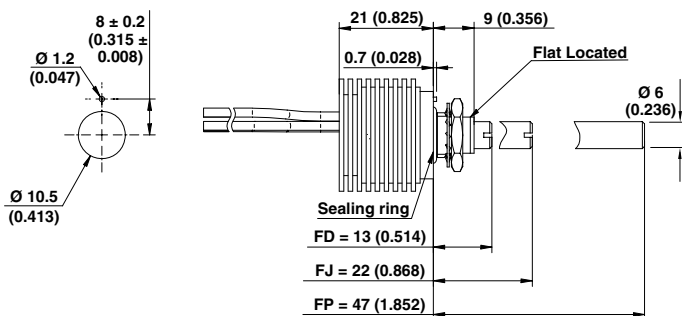

Available only with bushing M10 x 0.75 and shafts Ø 6 mm

## CIRCUIT DIAGRAM

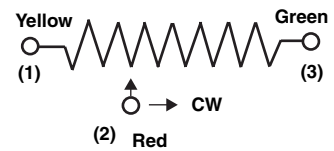

**SPECIAL FEATURES  
COMMAND SHAFT**

Length is measured from the mounting surface to the free end of the shaft. The screwdriver slot is aligned with the wiper within  $\pm 10^\circ$ . Special shafts are available, in accordance to drawings supplied by customers. We recommend that customers should not machine shafts, in order to avoid damage.

**PANEL SEALING: PE60M**

The panel sealing device consists of a ring located in a slot on the potentiometer face. Sealing is obtained by tightening the ring against the panel when mounting the potentiometer.

**SHAFT LOCKING: DBAN**

The shaft locking device consists of a tapered nut tightening a slotted notched washer against both bushing and shaft. DBAN tightening torque is 200 Ncm, shaft locking torque being 30 Ncm.

DBAN is also available with all special types.

This device is normally supplied in a separate bag. Can be pre-mounted on request.

**LOCATING PEG: LPRP**

Location is obtained by fitting a special washer on the potentiometer face. The peg can therefore be positioned at 90°, 180°, 270° and 360°.

ELECTRICAL SPECIFICATIONS		
Resistive Element		cermet
Electrical Travel		270° $\pm$ 10°
Resistance Range	Linear Law	1 $\Omega$ to 1 M $\Omega$
	Logarithmic Laws	100 $\Omega$ to 2.2 M $\Omega$
Standard series E3		1 - 2 - 2.5 - 5
Tolerance	Standard	$\pm$ 20 %
	On Request	$\pm$ 10 % - $\pm$ 5 %
Power Rating	Linear	6 W at + 50 °C
	Logarithmic	3 W at + 50 °C
Temperature Coefficient		see Standard Resistance Element Data
Limiting Element Voltage (Linear Law)		350 V
Contact Resistance Variation (Linear Law)		3 % Rn or 0.5 $\Omega$
End Resistance (Typical)		0.5 $\Omega$ or 1 %
Dielectric Strength (RMS)		2500 V
Insulation Resistance (500 VDC)		10 <sup>6</sup> M $\Omega$

**MECHANICAL SPECIFICATIONS**

Mechanical Travel	300° $\pm$ 5°
Operating Torque (max. Ncm)	3 typical
End Stop Torque (max. Ncm)	70
Max Tightening Torque of Mounting Nut (Ncm)	250
Unit Weight (max. g)	25 to 35

**ENVIRONMENTAL SPECIFICATIONS**

Temperature Range	- 55 °C to + 125 °C
Climatic Category	55/125/56
Sealing	fully sealed container IP67

**POWER RATING CHART**

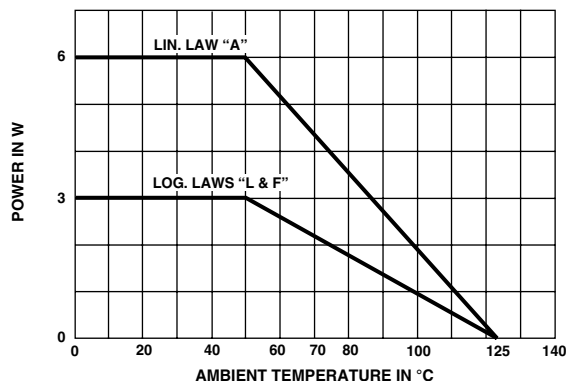

**RESISTANCE LAWS**

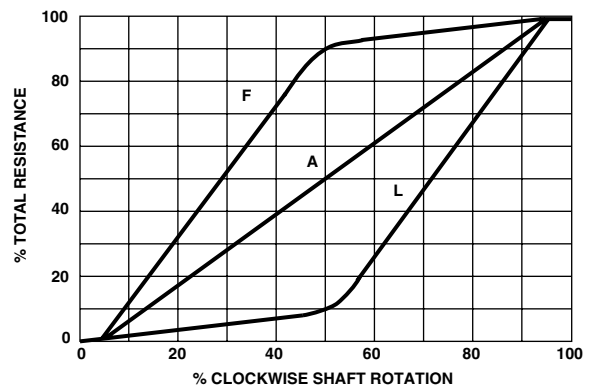



PERFORMANCE			
TESTS	CONDITIONS	TYPICAL VALUES AND DRIFTS	
		$\frac{\Delta RT}{RT}$ (%)	$\frac{\Delta R_{1-2}}{R_{1-2}}$ (%)
Climatic Sequence	Phase A dry heat 125 °C Phase B damp heat Phase C cold - 55 °C Phase D damp heat 5 cycles	± 0.5 %	± 1 %
Long Term Damp Heat	56 days	± 0.5 % Insulation resistance: > 10 <sup>4</sup> MΩ	± 1 %
Rotational Life	25 000 cycles	± 3 % Contact res. variation: < 5 % Rn	
Load Life	1000 hours at rated power 90°/30' - ambient temp. 25 °C	± 3 % Contact res. variation: < 3 % Rn	
Rapid Temperature Change	5 cycles - 55 °C at + 125 °C	± (0.5 % ± 0.1 Ω)	
Shock	50 g at 11 ms 3 successive shocks in 3 directions	± 0.1 %	± 0.2 %
Vibration	10 - 55 Hz 0.75 mm or 10 g during 6 hours	± 0.1 %	± 0.2 %

STANDARD RESISTANCE ELEMENT DATA				
STANDARD RESISTANCE VALUES	LINEAR LAW			TYPICAL TCR - 55 °C + 125 °C
	MAX. POWER AT 25 °C	MAX. WORKING VOLTAGE	MAX. CUR. THROUGH WIPER	
Ω	W	V	mA	ppm/°C
1	6	2.4	2449	± 500
2	↓	3.5	1732	
5		5.5	1095	
10		7.7	775	
20		11.0	548	
25		12.2	490	
50	↓	17.3	346	± 250
100		24.5	245	
200		34.6	173.2	
250		38.7	154.9	
500		54.8	109.5	
1K		77.5	77.5	
2K		110	54.8	
2.5K		122	49.0	
5K		173	34.64	
10K		245	24.49	
20K	6	346	17.32	
25K	4.90	350	14.00	
50K	2.45	↓	7.00	
100K	1.23		3.50	
200K	0.61		1.75	
250K	0.49		1.40	
500K	0.25		0.70	
1M	0.12	350	0.35	

**MARKING**

- Printed:
- VISHAY trademark
  - SAP Part number
  - manufacturing date

**PACKAGING**

- in box of 5 pieces



SAP ORDERING INFORMATION (Part Number 18 digits)																	
P	E	6	0	L	0	F	G	W	2	0	4	M	A				
MODEL	BUSHING	OPTION			SHAFT			LEADS	OHMIC VALUE	TOLERANCE		LAW		SPECIAL NUMBER			
	M = Panel sealed L = STD F = 3/8"	0 = none  For L Bushing D = DBAN L = LPRP B = DBAN and LPRP  For F Bushing L = LPRP  For M Bushing E = Peg			For L Bushing FG 16 mm, slotted FL 25 mm, slotted FR 50 mm, plain  For F Bushing GB 1/2", slotted GJ 7/8", slotted GR 2", slotted  For M Bushing FD = 13 mm, slotted FJ = 22 mm, slotted FP = 47 mm, plain			W: Wire	204 = 200 kΩ	± 20 % on request ± 10 % ± 5 %		A = Linear L = clockwise logarithmic F = clockwise inverse logarithmic		(if applicable)  Given by VISHAY for custom design			

PART NUMBER DESCRIPTION (for information only)											
PE60	L	0	FG	W	200 kΩ	20 %	A	BO5			e3
MODEL	BUSHING	OPTION	SHAFT	LEADS	OHMIC VALUE	TOL	LAW	PACKAGING	SPECIAL	SPECIAL	LEAD (Pb)-FREE



## Notice

Specifications of the products displayed herein are subject to change without notice. Vishay Intertechnology, Inc., or anyone on its behalf, assumes no responsibility or liability for any errors or inaccuracies.

Information contained herein is intended to provide a product description only. No license, express or implied, by estoppel or otherwise, to any intellectual property rights is granted by this document. Except as provided in Vishay's terms and conditions of sale for such products, Vishay assumes no liability whatsoever, and disclaims any express or implied warranty, relating to sale and/or use of Vishay products including liability or warranties relating to fitness for a particular purpose, merchantability, or infringement of any patent, copyright, or other intellectual property right.

The products shown herein are not designed for use in medical, life-saving, or life-sustaining applications. Customers using or selling these products for use in such applications do so at their own risk and agree to fully indemnify Vishay for any damages resulting from such improper use or sale.



## Стандарт Электрон Связь

Мы молодая и активно развивающаяся компания в области поставок электронных компонентов. Мы поставляем электронные компоненты отечественного и импортного производства напрямую от производителей и с крупнейших складов мира.

Благодаря сотрудничеству с мировыми поставщиками мы осуществляем комплексные и плановые поставки широчайшего спектра электронных компонентов.

Собственная эффективная логистика и склад в обеспечивает надежную поставку продукции в точно указанные сроки по всей России.

Мы осуществляем техническую поддержку нашим клиентам и предпродажную проверку качества продукции. На все поставляемые продукты мы предоставляем гарантию .

Осуществляем поставки продукции под контролем ВП МО РФ на предприятия военно-промышленного комплекса России , а также работаем в рамках 275 ФЗ с открытием отдельных счетов в уполномоченном банке. Система менеджмента качества компании соответствует требованиям ГОСТ ISO 9001.

Минимальные сроки поставки, гибкие цены, неограниченный ассортимент и индивидуальный подход к клиентам являются основой для выстраивания долгосрочного и эффективного сотрудничества с предприятиями радиоэлектронной промышленности, предприятиями ВПК и научно-исследовательскими институтами России.

С нами вы становитесь еще успешнее!

### Наши контакты:

**Телефон:** +7 812 627 14 35

**Электронная почта:** [sales@st-electron.ru](mailto:sales@st-electron.ru)

**Адрес:** 198099, Санкт-Петербург,  
Промышленная ул, дом № 19, литера Н,  
помещение 100-Н Офис 331