

3mm

LED CBI® Circuit Board Indicator
Bi-level

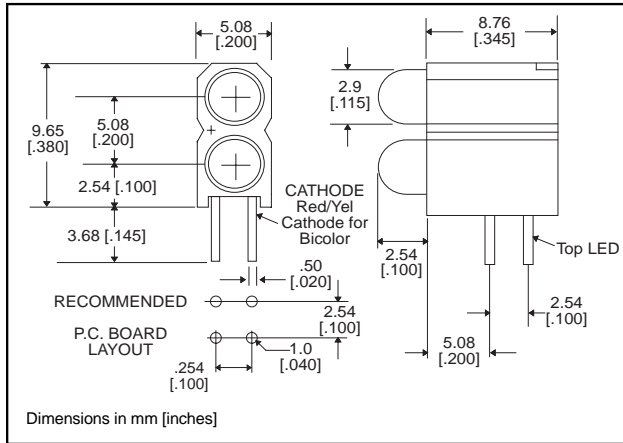

Standard Polarity shown in drawing: Cathode right

Features

- Multiple CBIs form horizontal LED arrays on 5.08mm (0.200") center-lines.
- High Contrast, UL 94 V-0 rated, black housing
- Oxygen index: 32%
- Polymer content: PBT, 0.405 g
- Housing stand-offs facilitate PCB cleaning
- Solderability per MIL-STD-202F, method 208F
- LEDs are safe for direct viewing per IEC 825-1, EN-60825-1
- Compatible with:
553-xxxx-306 Bi-Level Array

Tolerance note: As noted, otherwise:

- LED Protrusion: ±0.04 mm [±0.016]
- CBI Housing: ±0.02mm [±0.008]

Custom Combinations

- Contact factory for information on custom bi-level arrays and color combinations.

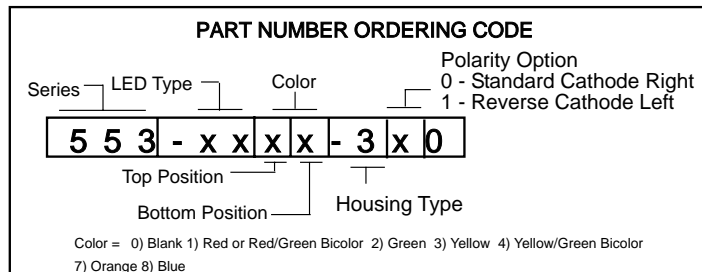

PART NO.

COLOR*

HIGH EFFICIENCY - LED TYPE 01

- 553-0111-300 Red
- 553-0122-300 Green
- 553-0133-300 Yellow
- 553-0177-300 Orange
- 553-0188-300 Blue³ ← **NEW**

LOW CURRENT - LED TYPE 02

- 553-0211-300 Red
- 553-0222-300 Green
- 553-0233-300 Yellow

RESISTOR 5 VOLTS - LED TYPE 03

- 553-0311-300 Red
- 553-0322-300 Green
- 553-0333-300 Yellow

BI-COLOR - LED TYPE 07

- 553-0711-300 Red/Green
- 553-0744-300 Yellow/Green

NON-DIFFUSED - LED TYPE 22

- 553-2211-300 Red
- 553-2222-300 Green
- 553-2233-300 Yellow

* Top-Bottom LED

REVERSE POLARITY OPTION AVAILABLE

See Part Number Ordering Code below.



ATTENTION
OBSERVE PRECAUTIONS
FOR HANDLING
ELECTROSTATIC
SENSITIVE
DEVICES

Typical Operating Characteristics ($T_A=25^\circ\text{C}$)

See LED data sheet for additional information
See page 4-70 and 4-71 for Reference Only LED Drive Circuit Examples. See page 4-72 for Pin Out

HIGH EFFICIENCY

Part Number	Color	Peak Wavelength nm	I_V mcd	V_F Volts	Test Current (mA)	Viewing Angle $2\theta_{\%}$	LED Data sheet	Page #
553-0111-300	Red	650	10	2	10	45°	521-9427	4-64
553-0122-300	Green	563	16	2.1	10	45°	521-9408	4-64
553-0133-300	Yellow	585	6.3	2.1	10	45°	521-9428	4-64
553-0177-300	Orange	600	7	2.2	10	60°	521-9498	4-58
553-0188-300	Blue	428	12	3.5	10	70°	521-9831	4-57

LOW CURRENT

Part Number	Color	Peak Wavelength nm	I_V mcd	V_F Volts	Test Current (mA)	Viewing Angle $2\theta_{\%}$	LED Data sheet	Page #
553-0211-300	Red	635	1.6	1.7	2	60°	521-9324	4-60
553-0222-300	Green	565	1.6	1.9	2	60°	521-9326	4-60
553-0233-300	Yellow	585	1.6	1.8	2	60°	521-9325	4-60

INTEGRAL RESISTOR, 5 VOLTS

Part Number	Color	Peak Wavelength nm	I_V mcd	Test Voltage	Forward Current (mA)	Viewing Angle $2\theta_{\%}$	LED Data sheet	Page #
553-0311-300	Red	635	29	5	10	60°	521-9215	4-59
553-0322-300	Green	565	19	5	10	60°	521-9323	4-59
553-0333-300	Yellow	585	12.6	5	10	60°	521-9322	4-59

BI-COLOR

Part Number	Color	Peak Wavelength nm	I_V mcd	V_F Volts	Test Current (mA)	Viewing Angle $2\theta_{\%}$	LED Data sheet	Page #
553-0711-300	Red/Green	635/565	4.7/10	2/2.1	10	50°	521-9459	4-63
553-0744-300	Yellow/Green	585/565	4.3/6.3	2.1*/2.1*	10	80°	521-9478	4-62

* $I_F = 20\text{mA}$

NON-DIFFUSED

Part Number	Color	Peak Wavelength nm	I_V mcd	V_F Volts*	Test Current (mA)	Viewing Angle $2\theta_{\%}$	LED Data sheet	Page #
553-2211-300	Red	635	29	2	10	45°	521-9432	4-61
553-2222-300	Green	565	50	2.1	10	45°	521-9430	4-61
553-2233-300	Yellow	585	20	2.1	10	45°	521-9431	4-61

* $I_F = 20\text{mA}$





3mm Discrete LED Tinted, Diffused

Dialight

521-9831



PART NO. 521-9831
COLOR Blue³

MOUNTING CLIP: 515-0006
located on page 4-65



ATTENTION
OBSERVE PRECAUTIONS
FOR HANDLING
ELECTROSTATIC
SENSITIVE
DEVICES

4

ABSOLUTE MAXIMUM RATINGS (T_A=25°C)

Blue
-9831

Power Dissipation (mW)	100
Forward Current (mA)	20
Derating (mA/°C) From 55°C	.44
Operating Temperature (°C)	-40/+100
Storage Temperature (°C)	-40/+100
Soldering Temperature	260°C, 5 seconds, 1.6 mm from case

Solder Adherence per MIL-STD-202E, Method 208C

OPERATING CHARACTERISTICS (T_A=25°C)

Blue
-9831

Luminous Intensity (mcd)	Min.	6.3
I _F =10mA	Typical	12
Peak Wavelength (nm)	Typical	428
λ Peak		
Viewing Angle (2Θ _{1/2})	Typical	70°
Forward Voltage (V)	Typical	3.5
I _F =10mA	Max.	4.2
Reverse Voltage (V) I _R =10μA	Min.	3

Θ_{1/2} is the off axis angle at which the luminous intensity is half the axial luminous intensity

3mm Discrete LED
High Efficiency
Diffused



521-9210, -9211, -9216, -9498, -9636

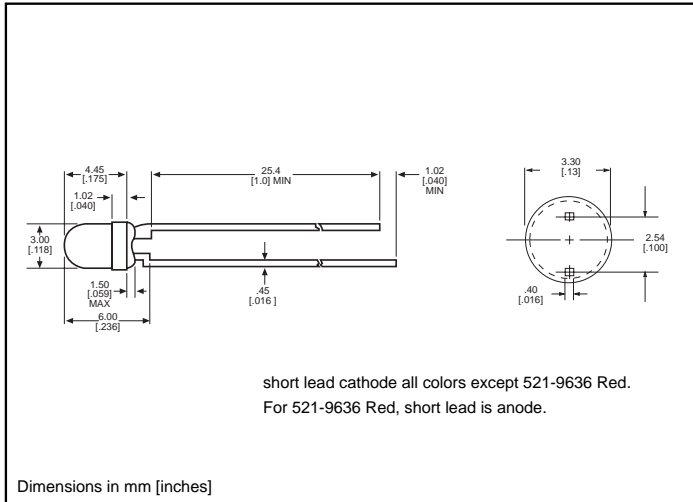

PART NO. COLOR

- 521-9210 Green
- 521-9211 Yellow
- 521-9216 Red
- 521-9498 Orange
- 521-9636 Red



MOUNTING CLIP: 515-0006
 located on page 4-65

ABSOLUTE MAXIMUM RATINGS (T _A =25°C)	Green -9210	Yellow -9211	Red -9216	Orange -9498	Red -9636
Power Dissipation (mW)	100	60	100	135	100
Forward Current (mA)	30	20	30	25	40
Derating (mA/°C) From 50°C 1 from 25°C	.4	.25	.4	.5	.5 ¹
Operating Temperature (°C)	-55/+100	-55/+100	-55/+100	-55/+100	-55/+100
Storage Temperature (°C)	-55/+100	-55/+100	-55/+100	-55/+100	-55/+100
Soldering Temperature	260°C, 5 seconds, 1.6 mm from body				

Solder Adherence per MIL-STD-202E, Method 208C

OPERATING CHARACTERISTICS (T _A =25°C)		Green -9210	Yellow -9211	Red -9216	Orange -9498	Red -9636
Luminous Intensity (mcd)	Min.	4.7	7.4	7.4	3.4	8.7 ¹
	I _F =10mA 1 I _F =20mA	Typical	12.6	10	10	7
Peak Wavelength (nm)	Typical	565	585	635	600	660
Viewing Angle (2θ °)	Typical	60°	60°	60°	60°	60°
Forward Voltage (V)	Typical	2.1 ¹	2.1 ¹	2 ¹	2.2	1.8 ¹
	I _F =10mA 1 I _F =20mA	Max.	2.8 ¹	2.8 ¹	2.8 ¹	3
Reverse Voltage (V), I _R =100µA	Max.	5	5	5	5	4

¹ θ is the off axis angle at which the luminous intensity is half the axial luminous intensity

**3mm Discrete LED
Integral Resistor, 5V
Diffused**

Dialight

521-9215, -9322, -9323



PART NO.	COLOR
521-9215	Red
521-9322	Yellow
521-9323	Green

MOUNTING CLIP: 515-0006
located on page 4-65

ABSOLUTE MAXIMUM RATINGS ($T_A=25^\circ\text{C}$)	Red	Yellow	Green
	-9215	-9322	-9323
Forward Voltage (V)	7.5	7.5	7.5
Derating ($V/^\circ\text{C}$) From 50°C	.086	.086	.071
Operating Temperature ($^\circ\text{C}$)	-40/+85	-40/+85	-20/+85
Storage Temperature ($^\circ\text{C}$)	-55/+100	-55/+100	-55/+100
Soldering Temperature	260 $^\circ\text{C}$, 5 seconds, 1.6 mm from case		

Solder Adherence per MIL-STD-202E, Method 208C

OPERATING CHARACTERISTICS ($T_A=25^\circ\text{C}$)		Red	Yellow	Green
		-9215	-9322	-9323
Luminous Intensity (mcd)	Min.	8.7	3.7	5.6
	Typical	29	12.6	19
Peak Wavelength (nm)	Typical	635	585	565
Viewing Angle ($2\theta_{1/2}$)	Typical	60 $^\circ$	60 $^\circ$	60 $^\circ$
Forward Current (mA)	Typical	10	10	10
	Max.	20	20	20
Reverse Voltage (V), $I_R=100\mu\text{A}$	Min.	5	5	5

$\theta_{1/2}$ is the off axis angle at which the luminous intensity is half the axial luminous intensity

4

3mm Discrete LED
Low Current
Diffused



521-9324, -9325, -9326

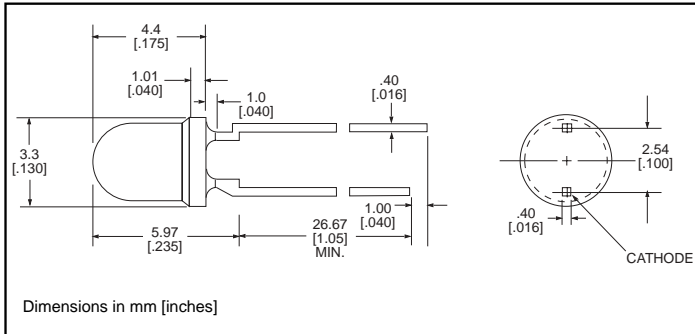

<u>PART NO.</u>	<u>COLOR</u>
521-9324	Red
521-9325	Yellow
521-9326	Green

MOUNTING CLIP: 515-0006
 located on page 4-65

ABSOLUTE MAXIMUM RATINGS ($T_A=25^\circ\text{C}$)

	Red -9324	Yellow -9325	Green -9326
Power Dissipation (mW)	20	20	20
Forward Current (mA)	7	7	7
Derating (mA/ $^\circ\text{C}$) From 90 $^\circ\text{C}$.7	.7	.7
Peak Current (mA) Pulse width = 10 μs	500	500	500
Operating Temperature ($^\circ\text{C}$)	-55/+100	-55/+100	-55/+100
Storage Temperature ($^\circ\text{C}$)	-55/+100	-55/+100	-55/+100
Soldering Temperature	260 $^\circ\text{C}$, 5 seconds, 1.6 mm from case		

Solder Adherence per MIL-STD-202E, Method 208C

OPERATING CHARACTERISTICS ($T_A=25^\circ\text{C}$)

		Red -9324	Yellow -9325	Green -9326
Luminous Intensity (mcd) $I_F=2\text{mA}$	Min.	1	1	1
	Typical	1.6	1.6	1.6
Peak Wavelength (nm) λ Peak	Typical	635	585	565
Viewing Angle (2θ $\%$)	Typical	60 $^\circ$	60 $^\circ$	60 $^\circ$
Forward Voltage (V) $I_F=2\text{mA}$	Typical	1.7	1.8	1.9
	Max.	2.2	2.7	2.2
Reverse Voltage (V), $I_R=50\mu\text{A}$	Min.	5	5	5

θ is the off axis angle at which the luminous intensity is half the axial luminous intensity

3mm Discrete LED
High Efficiency
Tinted, Non-Diffused

Dialight

521-9430, -9431, -9432

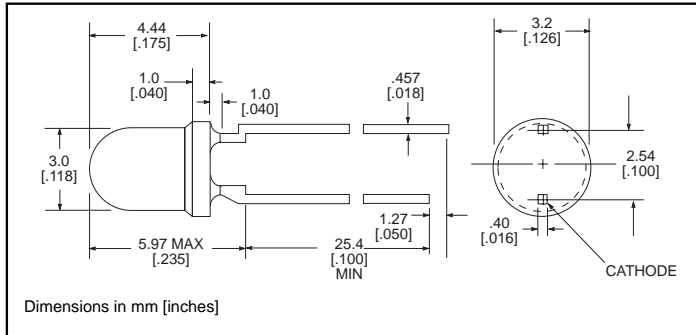

PART NO.

COLOR

521-9430
 521-9431
 521-9432

Green
 Yellow
 Red

MOUNTING CLIP: 515-0006
 located on page 4-65

ABSOLUTE MAXIMUM RATINGS ($T_A=25^\circ\text{C}$)

	Green -9430	Yellow -9431	Red -9432
Power Dissipation (mW)	100	60	100
Forward Current (mA)	30	20	30
Derating (mA/°C) From 50°C	.4	.25	.4
Peak Current (mA) Pulse width = 100µs	120	80	120
Operating Temperature (°C)	-55/+100	-55/+100	-55/+100
Storage Temperature (°C)	-55/+100	-55/+100	-55/+100
Soldering Temperature	260°C, 5 seconds, 1.6 mm from case		

Solder Adherence per MIL-STD-202E, Method 208C

OPERATING CHARACTERISTICS ($T_A=25^\circ\text{C}$)

		Green -9430	Yellow -9431	Red -9432
Luminous Intensity (mcd) $I_F=10\text{mA}$	Min.	32	10	8.7
	Typical	50	20	29
Peak Wavelength (nm) λ Peak	Typical	565	585	635
Viewing Angle ($2\theta_{1/2}$)	Typical	45°	45°	45°
Forward Voltage (V) $I_F=20\text{mA}$	Typical	2.1	2.1	2
	Max.	2.8	2.8	2.8

$\theta_{1/2}$ is the off axis angle at which the luminous intensity is half the axial luminous intensity

4

3mm Discrete LED
Bi-Color
Non-Tinted, Diffused



521-9478, -9628, -9768

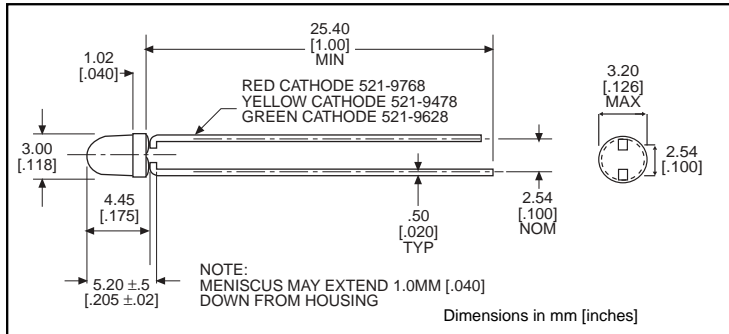

<u>PART NO.</u>	<u>COLOR</u>
521-9478	Yellow/Green
521-9628	Red/Green
521-9768	Red/Yellow

MOUNTING CLIP: 515-0006
 located on page 4-65

ABSOLUTE MAXIMUM RATINGS ($T_A=25^\circ\text{C}$)	Yellow/Green -9478	Red/Green -9628	Red/Yellow -9768
Power Dissipation (mW)	60/100	140/100	100/60
Forward Current (mA)	20/30	40/30	30/20
Derating (mA/°C) From 25°C From 50°C	.25 ¹ /.40 ¹	.5/.4	.4 ¹ /.25 ¹
Peak Current (mA) Pulse width = 10µs	80/120	200/120	120/80
Operating Temperature (°C)	-55/+100	-55/+100	-55/+100
Storage Temperature (°C)	-55/+100	-55/+100	-55/+100
Soldering Temperature	260°C, 5 seconds, 1.66 mm from case		

Solder Adherence per MIL-STD-202E, Method 208C

OPERATING CHARACTERISTICS ($T_A=25^\circ\text{C}$)		Yellow/Green -9478	Red/Green -9628	Red/Yellow -9768
Luminous Intensity (mcd)	Min.	2.5/2.5	3.7*/1.1*	1.7*/1.7*
	Typical	4.3/6.3	12.6*/3.7*	5.6*/5.6*
Peak Wavelength (nm) λ Peak	Typical	585/565	660/565	630/585
Viewing Angle (2θ °)	Typical	80°	200°	80°
Forward Voltage (V)	Typical	2.1/2.1	1.8/2.1	2/2.1
	Max.	2.8/2.8	2.4/2.8	2.8/2.8
Reverse Voltage (V) I _R =100ua	Min.	5	5	5

θ¹ is the off axis angle at which the luminous intensity is half the axial luminous intensity

**3mm Discrete LED
Bi-Color
Non-Tinted, Diffused**

Dialight

521-9459

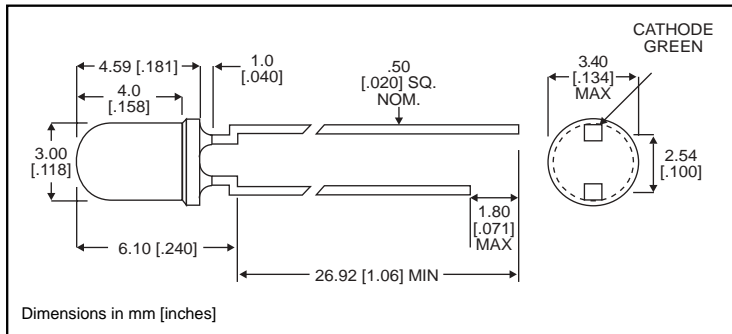

PART NO.

521-9459

COLOR

Red/Green

MOUNTING CLIP: 515-0006

located on page 4-65

4

ABSOLUTE MAXIMUM RATINGS ($T_A=25^\circ\text{C}$)

Red/Green
-9459

Power Dissipation (mW)	140
Forward Current (mA)	45
Derating (mA/°C) From 25°C	.6
Peak Current (mA) <i>Pulse width = 10µs</i>	1000
Operating Temperature (°C)	-55/+100
Storage Temperature (°C)	-55/+100
Soldering Temperature	260°C, 5 seconds, 1.6 mm from case

Solder Adherence per MIL-STD-202E, Method 208C

OPERATING CHARACTERISTICS ($T_A=25^\circ\text{C}$)

Red/Green
-9459

Luminous Intensity (mcd) $I_F=10\text{mA}$	Min. Typical	2.5/3.7 4.7/10
Peak Wavelength (nm) λ_{Peak}	Typical	635/565
Viewing Angle ($2\theta_{1/2}$)	Typical	50°
Forward Voltage (V) $I_F=10\text{mA}$	Typical Max.	2/2.1 2.8/2.8

$\theta_{1/2}$ is the off axis angle at which the luminous intensity is half the axial luminous intensity

3mm Discrete LED High Efficiency Diffused

Dialight

521-94xx



TYPE
521-9408
521-9427
521-9428

COLOR
Green
Red
Yellow

MOUNTING CLIP: 515-0006
located on page 4-65

ABSOLUTE MAXIMUM RATINGS (T_A=25°C)

	Green -9408	Red -9427	Yellow -9428
Power Dissipation (mW)	75	60	60
Forward Current (mA)	25	20	20
Derating (mA/°C) From 50°C	.5	.5	.5
Peak Current (mA)	60	60	60
Operating Temperature (°C)	-25/+85	-25/+85	-25/+85
Storage Temperature (°C)	-30/+100	-30/+100	-30/+100
Soldering Temperature	260°C, 5 seconds, 1.6 mm from case		

Solder Adherence per MIL-STD-202E, Method 208C

OPERATING CHARACTERISTICS (T_A=25°C)

		Green -9408	Red -9427	Yellow -9428
Luminous Intensity (mcd)	Min.	5.6	3.6	2.2
	Typical	16	10	6.3
Peak Wavelength (nm)	Typical	563	650	585
Viewing Angle (2θ ^{1/2})	Typical	45°	45°	45°
Forward Voltage (V)	Typical	2.1	2	2.1
	Max.	3	3	3
Reverse Voltage (V), I _R =10μA	Min.	3	3	3

θ^{1/2} is the off axis angle at which the luminous intensity is half the axial luminous intensity



Стандарт Электрон Связь

Мы молодая и активно развивающаяся компания в области поставок электронных компонентов. Мы поставляем электронные компоненты отечественного и импортного производства напрямую от производителей и с крупнейших складов мира.

Благодаря сотрудничеству с мировыми поставщиками мы осуществляем комплексные и плановые поставки широчайшего спектра электронных компонентов.

Собственная эффективная логистика и склад в обеспечивает надежную поставку продукции в точно указанные сроки по всей России.

Мы осуществляем техническую поддержку нашим клиентам и предпродажную проверку качества продукции. На все поставляемые продукты мы предоставляем гарантию .

Осуществляем поставки продукции под контролем ВП МО РФ на предприятия военно-промышленного комплекса России , а также работаем в рамках 275 ФЗ с открытием отдельных счетов в уполномоченном банке. Система менеджмента качества компании соответствует требованиям ГОСТ ISO 9001.

Минимальные сроки поставки, гибкие цены, неограниченный ассортимент и индивидуальный подход к клиентам являются основой для выстраивания долгосрочного и эффективного сотрудничества с предприятиями радиоэлектронной промышленности, предприятиями ВПК и научно-исследовательскими институтами России.

С нами вы становитесь еще успешнее!

Наши контакты:

Телефон: +7 812 627 14 35

Электронная почта: sales@st-electron.ru

Адрес: 198099, Санкт-Петербург,
Промышленная ул, дом № 19, литера Н,
помещение 100-Н Офис 331