

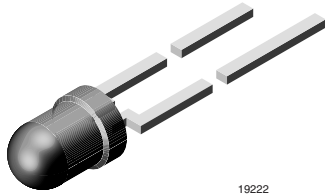

# High Intensity LED in Ø 3 mm Tinted Diffused Package



## DESCRIPTION

These devices have been designed to meet the increasing demand for AllnGaP technology general indicating and lighting purposes.

They are housed in a 3 mm diffused plastic package. The wide viewing angle of these devices provides a high brightness.

All packing units are categorized in luminous intensity groups. That allows users to assemble LEDs with uniform appearance.

## PRODUCT GROUP AND PACKAGE DATA

- Product group: LED
- Package: 3 mm
- Product series: low current
- Angle of half intensity:  $\pm 30^\circ$

## FEATURES

- AllnGaP technology
- Standard Ø 3 mm (T-1) package
- Small mechanical tolerances
- Wide viewing angle
- Very high intensity
- Low power consumption
- Specified at  $I_F = 2 \text{ mA}$
- Luminous intensity categorized
- ESD-withstand voltage: up to 2 kV HBM according to JESD22-A114-B
- Material categorization: for definitions of compliance please see [www.vishay.com/doc?99912](http://www.vishay.com/doc?99912)



## APPLICATIONS

- Status lights
- Off / on indicator
- Background illumination
- Readout lights
- Maintenance lights
- Legend light
- Low power DC circuits

| PARTS TABLE |           |                          |      |      |               |                 |      |      |               |                     |      |      |               |                 |
|-------------|-----------|--------------------------|------|------|---------------|-----------------|------|------|---------------|---------------------|------|------|---------------|-----------------|
| PART        | COLOR     | LUMINOUS INTENSITY (mcd) |      |      | at $I_F$ (mA) | WAVELENGTH (nm) |      |      | at $I_F$ (mA) | FORWARD VOLTAGE (V) |      |      | at $I_F$ (mA) | TECHNOLOGY      |
|             |           | MIN.                     | TYP. | MAX. |               | MIN.            | TYP. | MAX. |               | MIN.                | TYP. | MAX. |               |                 |
| TLLK4401    | Super red | 6.3                      | 17   | 32   | 2             | 626             | 630  | 639  | 2             | 1.6                 | 1.8  | 2.2  | 2             | AllnGaP on GaAs |
| TLLE4401    | Yellow    | 6.3                      | 17   | 32   | 2             | 581             | 589  | 594  | 2             | 1.6                 | 1.8  | 2.2  | 2             | AllnGaP on GaAs |

| ABSOLUTE MAXIMUM RATINGS ( $T_{amb} = 25^\circ\text{C}$ , unless otherwise specified) |                                       |            |             |                  |
|---|---------------------------------------|------------|-------------|------------------|
| TLLK4401, TLLE4401  |                                       |            |             |                  |
| PARAMETER   | TEST CONDITION                        | SYMBOL     | VALUE       | UNIT             |
| Reverse voltage <sup>(1)</sup>  |                                       | $V_R$      | 5           | V                |
| DC forward current  | $T_{amb} \leq 60^\circ\text{C}$       | $I_F$      | 30          | mA               |
| Surge forward current   | $t_p \leq 10 \mu\text{s}$             | $I_{FSM}$  | 0.1         | A                |
| Power dissipation   | $T_{amb} \leq 60^\circ\text{C}$       | $P_V$      | 80          | mW               |
| Junction temperature  |                                       | $T_j$      | 100         | $^\circ\text{C}$ |
| Operating temperature range   |                                       | $T_{amb}$  | -40 to +100 | $^\circ\text{C}$ |
| Storage temperature range   |                                       | $T_{stg}$  | -55 to +100 | $^\circ\text{C}$ |
| Soldering temperature   | $t \leq 5 \text{ s}$ , 2 mm from body | $T_{sd}$   | 260         | $^\circ\text{C}$ |
| Thermal resistance junction/ambient   |                                       | $R_{thJA}$ | 400         | K/W              |

### Note

<sup>(1)</sup> Driving the LED in reverse direction is suitable for a short term application

**OPTICAL AND ELECTRICAL CHARACTERISTICS** ( $T_{amb} = 25\text{ }^{\circ}\text{C}$ , unless otherwise specified)  
**TLLK4401, SUPER RED**

| PARAMETER                         | TEST CONDITION                          | SYMBOL      | MIN. | TYP.     | MAX. | UNIT |
|-----------------------------------|---|-------------|------|----------|------|------|
| Luminous intensity <sup>(1)</sup> | $I_F = 2\text{ mA}$                     | $I_V$       | 6.3  | 17       | 32   | mcd  |
| Dominant wavelength               | $I_F = 2\text{ mA}$                     | $\lambda_d$ | 626  | 630      | 639  | nm   |
| Peak wavelength                   | $I_F = 2\text{ mA}$                     | $\lambda_p$ | -    | 643      | -    | nm   |
| Angle of half intensity           | $I_F = 2\text{ mA}$                     | $\phi$      | -    | $\pm 30$ | -    | deg  |
| Forward voltage                   | $I_F = 2\text{ mA}$                     | $V_F$       | 1.6  | 1.8      | 2.2  | V    |
| Reverse voltage                   | $I_R = 10\text{ }\mu\text{A}$           | $V_R$       | 5    | -        | -    | V    |
| Junction capacitance              | $V_R = 0\text{ V}$ , $f = 1\text{ MHz}$ | $C_j$       | -    | 15       | -    | pF   |

**Note**(1) In one packing unit  $I_{Vmin}/I_{Vmax} \leq 0.5$ .**OPTICAL AND ELECTRICAL CHARACTERISTICS** ( $T_{amb} = 25\text{ }^{\circ}\text{C}$ , unless otherwise specified)  
**TLLE4401, YELLOW**

| PARAMETER                         | TEST CONDITION                          | SYMBOL      | MIN. | TYP.     | MAX. | UNIT |
|-----------------------------------|---|-------------|------|----------|------|------|
| Luminous intensity <sup>(1)</sup> | $I_F = 2\text{ mA}$                     | $I_V$       | 6.3  | 17       | 32   | mcd  |
| Dominant wavelength               | $I_F = 2\text{ mA}$                     | $\lambda_d$ | 581  | 589      | 594  | nm   |
| Peak wavelength                   | $I_F = 2\text{ mA}$                     | $\lambda_p$ | -    | 591      | -    | nm   |
| Angle of half intensity           | $I_F = 2\text{ mA}$                     | $\phi$      | -    | $\pm 30$ | -    | deg  |
| Forward voltage                   | $I_F = 2\text{ mA}$                     | $V_F$       | 1.6  | 1.8      | 2.2  | V    |
| Reverse voltage                   | $I_R = 10\text{ }\mu\text{A}$           | $V_R$       | 5    | -        | -    | V    |
| Junction capacitance              | $V_R = 0\text{ V}$ , $f = 1\text{ MHz}$ | $C_j$       | -    | 15       | -    | pF   |

**Note**(1) In one packing unit  $I_{Vmin}/I_{Vmax} \leq 0.5$ .**LUMINOUS INTENSITY CLASSIFICATION**

| GROUP | LIGHT INTENSITY (mcd) |      |
|-------|-----------------------|------|
|       | MIN.                  | MAX. |
| Q     | 6.3                   | 12.5 |
| R     | 10                    | 20   |
| S     | 16                    | 32   |

**Note**

- Luminous intensity is tested at a current pulse duration of 25 ms. The above type numbers represent the order groups which include only a few brightness groups. Only one group will be shipped on each bag (there will be no mixing of two groups on each bag). In order to ensure availability, single brightness groups will not be orderable. In a similar manner for colors where wavelength groups are measured and binned, single wavelength groups will be shipped on any one bag. In order to ensure availability, single wavelength groups will not be orderable.

**COLOR CLASSIFICATION**

| GROUP | YELLOW               |      |
|-------|----------------------|------|
|       | DOM. WAVELENGTH (nm) |      |
|       | MIN.                 | MAX. |
| 1     | 581                  | 584  |
| 2     | 583                  | 586  |
| 3     | 585                  | 588  |
| 4     | 587                  | 590  |
| 5     | 589                  | 592  |
| 6     | 591                  | 594  |

**Note**

- Wavelengths are tested at a current pulse duration of 25 ms.

**TYPICAL CHARACTERISTICS** ( $T_{amb} = 25\text{ }^{\circ}\text{C}$ , unless otherwise specified)

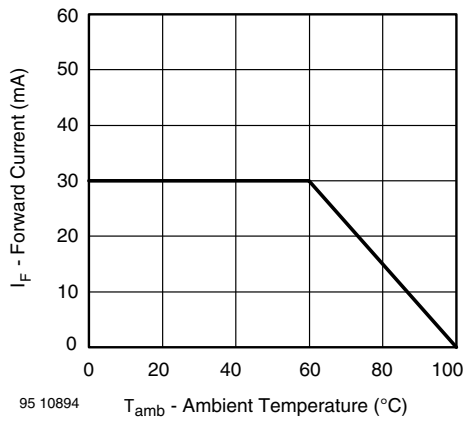

Fig. 1 - Forward Current vs. Ambient Temperature

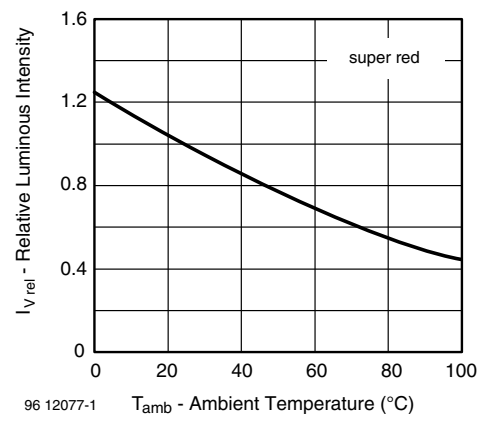

Fig. 4 - Relative Luminous Intensity vs. Ambient Temperature

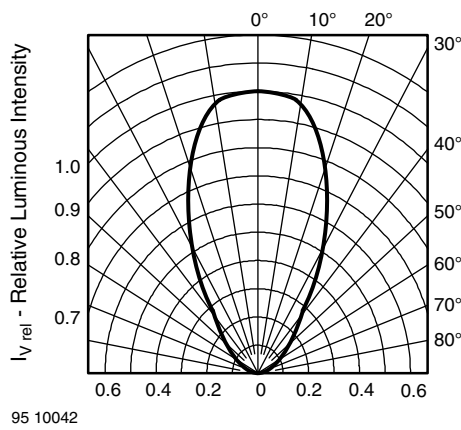

Fig. 2 - Relative Luminous Intensity vs. Angular Displacement

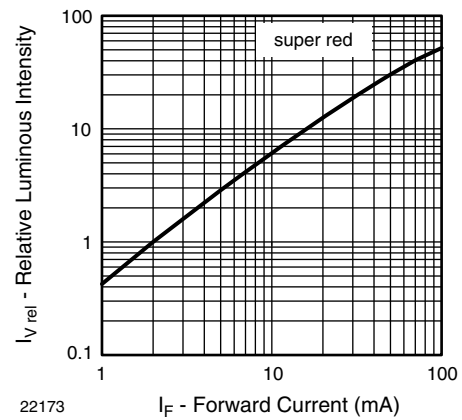

Fig. 5 - Relative Luminous Intensity vs. Forward Current

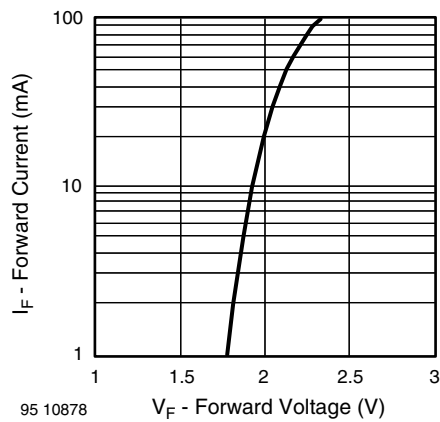

Fig. 3 - Forward Current vs. Forward Voltage

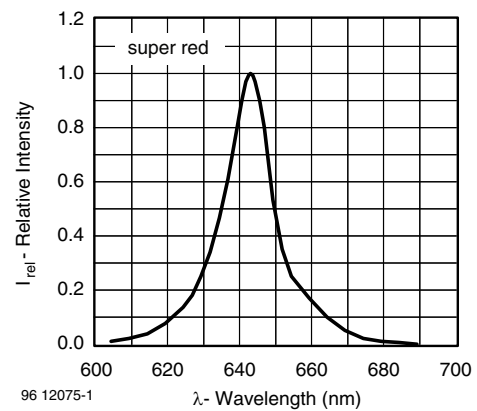

Fig. 6 - Relative Intensity vs. Wavelength

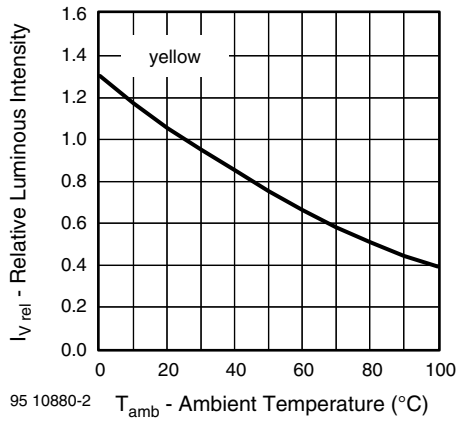

Fig. 7 - Relative Luminous Intensity vs. Ambient Temperature

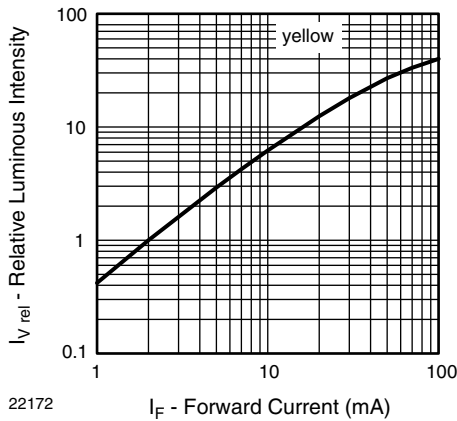

Fig. 8 - Relative Luminous Intensity vs. Forward Current

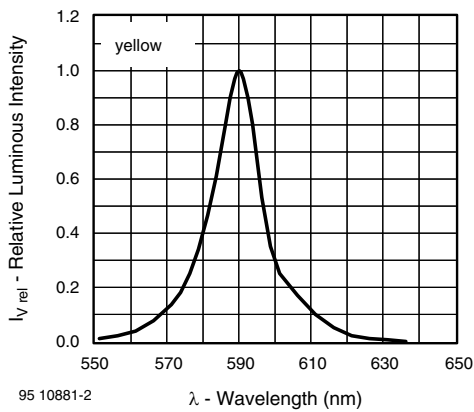
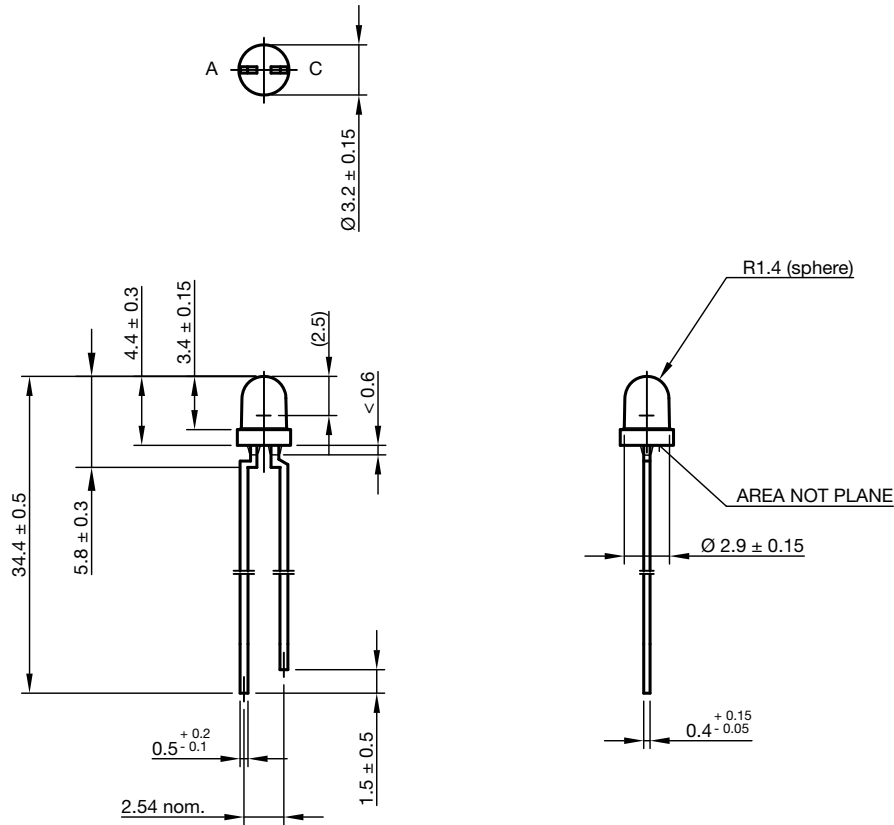
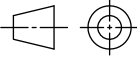

Fig. 9 - Relative Luminous Intensity vs. Wavelength



**PACKAGE DIMENSIONS** in millimeters



  
technical drawings  
according to DIN  
specifications

Drawing-No.: 6.544-5255.01-4  
Issue: 9; 28.07.14



## **Disclaimer**

ALL PRODUCT, PRODUCT SPECIFICATIONS AND DATA ARE SUBJECT TO CHANGE WITHOUT NOTICE TO IMPROVE RELIABILITY, FUNCTION OR DESIGN OR OTHERWISE.

Vishay Intertechnology, Inc., its affiliates, agents, and employees, and all persons acting on its or their behalf (collectively, "Vishay"), disclaim any and all liability for any errors, inaccuracies or incompleteness contained in any datasheet or in any other disclosure relating to any product.

Vishay makes no warranty, representation or guarantee regarding the suitability of the products for any particular purpose or the continuing production of any product. To the maximum extent permitted by applicable law, Vishay disclaims (i) any and all liability arising out of the application or use of any product, (ii) any and all liability, including without limitation special, consequential or incidental damages, and (iii) any and all implied warranties, including warranties of fitness for particular purpose, non-infringement and merchantability.

Statements regarding the suitability of products for certain types of applications are based on Vishay's knowledge of typical requirements that are often placed on Vishay products in generic applications. Such statements are not binding statements about the suitability of products for a particular application. It is the customer's responsibility to validate that a particular product with the properties described in the product specification is suitable for use in a particular application. Parameters provided in datasheets and / or specifications may vary in different applications and performance may vary over time. All operating parameters, including typical parameters, must be validated for each customer application by the customer's technical experts. Product specifications do not expand or otherwise modify Vishay's terms and conditions of purchase, including but not limited to the warranty expressed therein.

Except as expressly indicated in writing, Vishay products are not designed for use in medical, life-saving, or life-sustaining applications or for any other application in which the failure of the Vishay product could result in personal injury or death. Customers using or selling Vishay products not expressly indicated for use in such applications do so at their own risk. Please contact authorized Vishay personnel to obtain written terms and conditions regarding products designed for such applications.

No license, express or implied, by estoppel or otherwise, to any intellectual property rights is granted by this document or by any conduct of Vishay. Product names and markings noted herein may be trademarks of their respective owners.



## Стандарт Электрон Связь

Мы молодая и активно развивающаяся компания в области поставок электронных компонентов. Мы поставляем электронные компоненты отечественного и импортного производства напрямую от производителей и с крупнейших складов мира.

Благодаря сотрудничеству с мировыми поставщиками мы осуществляем комплексные и плановые поставки широчайшего спектра электронных компонентов.

Собственная эффективная логистика и склад в обеспечивает надежную поставку продукции в точно указанные сроки по всей России.

Мы осуществляем техническую поддержку нашим клиентам и предпродажную проверку качества продукции. На все поставляемые продукты мы предоставляем гарантию .

Осуществляем поставки продукции под контролем ВП МО РФ на предприятия военно-промышленного комплекса России , а также работаем в рамках 275 ФЗ с открытием отдельных счетов в уполномоченном банке. Система менеджмента качества компании соответствует требованиям ГОСТ ISO 9001.

Минимальные сроки поставки, гибкие цены, неограниченный ассортимент и индивидуальный подход к клиентам являются основой для выстраивания долгосрочного и эффективного сотрудничества с предприятиями радиоэлектронной промышленности, предприятиями ВПК и научно-исследовательскими институтами России.

С нами вы становитесь еще успешнее!

### Наши контакты:

**Телефон:** +7 812 627 14 35

**Электронная почта:** [sales@st-electron.ru](mailto:sales@st-electron.ru)

**Адрес:** 198099, Санкт-Петербург,  
Промышленная ул, дом № 19, литера Н,  
помещение 100-Н Офис 331