

# MC74LCX06

## Low-Voltage CMOS Hex Inverter with Open Drain Outputs

### With 5 V – Tolerant Inputs

The MC74LCX06 is a high performance hex inverter operating from a 2.3 V to 3.6 V supply. High impedance TTL compatible inputs significantly reduce current loading to input drivers. These LCX devices have open drain outputs which provide the ability to set output levels, or do active-HIGH AND or active-LOW OR functions. A  $V_I$  specification of 5.5 V allows MC74LCX06 inputs to be safely driven from 5.0 V devices.

#### Features

- Designed for 2.3 V to 3.6 V  $V_{CC}$  Operation
- 5.0 V Tolerant Inputs/Outputs
- LVTTTL Compatible
- LVCMOS Compatible
- 24 mA Output Sink Capability
- Near Zero Static Supply Current (10  $\mu$ A) Substantially Reduces System Power Requirements
- Latchup Performance Exceeds 500 mA
- Wired-OR, Wired-AND
- Output Level Can Be Set Externally Without Affecting Speed of Device
- Functionally Compatible with LCX05
- ESD Performance: Human Body Model >1500 V;  
Machine Model >200 V
- These Devices are Pb-Free, Halogen Free/BFR Free and are RoHS Compliant

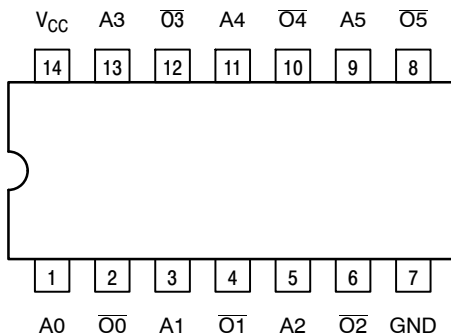

Figure 1. Pinout: 14-Lead (Top View)



ON Semiconductor®

<http://onsemi.com>

#### MARKING DIAGRAMS

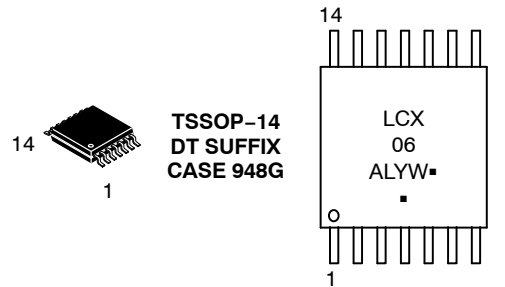
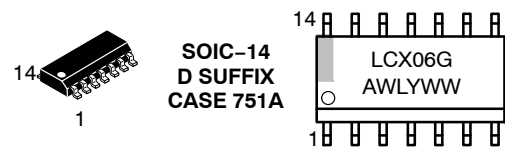

A = Assembly Location  
 WL, L = Wafer Lot  
 Y = Year  
 WW, W = Work Week  
 G or ■ = Pb-Free Package

(Note: Microdot may be in either location)

#### ORDERING INFORMATION

See detailed ordering and shipping information in the package dimensions section on page 2 of this data sheet.

# MC74LCX06



Figure 2. Logic Diagram

Table 1. PIN NAMES

Pins	Function
$A_n$ $\overline{O}_n$	Data Inputs Outputs

Table 2. TRUTH TABLE

$A_n$	$\overline{O}_n$
L	Z
H	L

## MAXIMUM RATINGS

Symbol	Parameter	Value	Condition	Unit
$V_{CC}$	DC Supply Voltage	-0.5 to +7.0		V
$V_I$	DC Input Voltage	$-0.5 \leq V_I \leq +7.0$		V
$V_O$	DC Output Voltage	$-0.5 \leq V_O \leq +7.0$	Output in HIGH or LOW State (Note 1)	V
$I_{IK}$	DC Input Diode Current	-50	$V_I < \text{GND}$	mA
$I_{OK}$	DC Output Diode Current	-50	$V_O < \text{GND}$	mA
		+50	$V_O > V_{CC}$	mA
$I_O$	DC Output/Sink Current	+50		mA
$I_{CC}$	DC Supply Current Per Supply Pin	$\pm 100$		mA
$I_{GND}$	DC Ground Current Per Ground Pin	$\pm 100$		mA
$T_{STG}$	Storage Temperature Range	-65 to +150		$^{\circ}\text{C}$
MSL	Moisture Sensitivity		Level 1	

Maximum ratings are those values beyond which device damage can occur. Maximum ratings applied to the device are individual stress limit values (not normal operating conditions) and are not valid simultaneously. If these limits are exceeded, device functional operation is not implied, damage may occur and reliability may be affected.

1.  $I_O$  absolute maximum rating must be observed.

## ORDERING INFORMATION

Device	Package	Shipping <sup>†</sup>
MC74LCX06DG	SOIC-14 (Pb-Free)	55 Units / Rail
MC74LCX06DR2G	SOIC-14 (Pb-Free)	2500 / Tape & Reel
MC74LCX06DTG	TSSOP-14 (Pb-Free)	96 Units / Rail
MC74LCX06DTR2G	TSSOP-14 (Pb-Free)	2500 / Tape & Reel

<sup>†</sup>For information on tape and reel specifications, including part orientation and tape sizes, please refer to our Tape and Reel Packaging Specifications Brochure, BRD8011/D.

# MC74LCX06

## RECOMMENDED OPERATING CONDITIONS

Symbol	Parameter	Min	Typ	Max	Unit	
V <sub>CC</sub>	Supply Voltage	Operating	2.0	2.5, 3.3	3.6	V
		Data Retention Only	1.5	2.5, 3.3	3.6	
V <sub>I</sub>	Input Voltage	0		5.5	V	
V <sub>O</sub>	Output Voltage (HIGH or LOW State)	0		V <sub>CC</sub>	V	
I <sub>OL</sub>	LOW Level Output Current Sink			V <sub>CC</sub> = 3.0 V - 3.6 V V <sub>CC</sub> = 2.7 V - 3.0 V V <sub>CC</sub> = 2.3 V - 2.7 V	+24 +12 +8	mA
T <sub>A</sub>	Operating Free-Air Temperature	-40		+85	°C	
Δt/ΔV	Input Transition Rise or Fall Rate, V <sub>IN</sub> from 0.8 V to 2.0 V, V <sub>CC</sub> = 3.0 V	0		10	ns/V	

## DC ELECTRICAL CHARACTERISTICS (T<sub>A</sub> = -40°C to +85°C)

Symbol	Characteristic	Condition	Min	Max	Unit
V <sub>IH</sub>	HIGH Level Input Voltage (Note 2)	2.3 V ≤ V <sub>CC</sub> ≤ 2.7 V	1.7		V
		2.7 V ≤ V <sub>CC</sub> ≤ 3.6 V	2.0		
V <sub>IL</sub>	LOW Level Input Voltage (Note 2)	2.3 V ≤ V <sub>CC</sub> ≤ 2.7 V		0.7	V
		2.7 V ≤ V <sub>CC</sub> ≤ 3.6 V		0.8	
V <sub>OL</sub>	LOW Level Output Voltage	2.3 V ≤ V <sub>CC</sub> ≤ 3.6 V; I <sub>OL</sub> = 100 μA		0.2	V
		V <sub>CC</sub> = 2.3 V; I <sub>OL</sub> = 8 mA		0.3	
		V <sub>CC</sub> = 2.7 V; I <sub>OL</sub> = 12 mA		0.4	
		V <sub>CC</sub> = 3.0 V; I <sub>OL</sub> = 16 mA		0.4	
		V <sub>CC</sub> = 3.0 V; I <sub>OL</sub> = 24 mA		0.55	
I <sub>OZ</sub>	3-State Output Current	V <sub>CC</sub> = 3.6 V, V <sub>IN</sub> = V <sub>IH</sub> or V <sub>IL</sub> , V <sub>OUT</sub> = 0 to 5.5 V		±5	μA
I <sub>OFF</sub>	Power Off Leakage Current	V <sub>CC</sub> = 0, V <sub>IN</sub> = 5.5 V or V <sub>OUT</sub> = 5.5 V		10	μA
I <sub>IN</sub>	Input Leakage Current	V <sub>CC</sub> = 3.6 V, V <sub>IN</sub> = 5.5 V or GND		±5	μA
I <sub>CC</sub>	Quiescent Supply Current	V <sub>CC</sub> = 3.6 V, V <sub>IN</sub> = 5.5 V or GND		10	μA
ΔI <sub>CC</sub>	Increase in I <sub>CC</sub> per Input	2.3 V ≤ V <sub>CC</sub> ≤ 3.6 V One Input at V <sub>IH</sub> = V <sub>CC</sub> - 0.6 V		500	μA

2. These values of V<sub>I</sub> are used to test DC electrical characteristics only.

## AC ELECTRICAL CHARACTERISTICS (T<sub>A</sub> = -40°C to +85°C)

Symbol	Parameter	V <sub>CC</sub> = 3.3 V ± 0.3 V C <sub>L</sub> = 50 pF		V <sub>CC</sub> = 2.7 V C <sub>L</sub> = 50 pF		V <sub>CC</sub> = 2.5 V ± 0.2 V C <sub>L</sub> = 30 pF		Unit
		Min	Max	Min	Max	Min	Max	
t <sub>PLZ</sub>	Propagation Delay	0.8	3.7	1.0	4.1	0.8	3.5	ns
t <sub>PZL</sub>	Input to Output	0.8	3.7	1.0	4.1	0.8	3.5	ns

## DYNAMIC SWITCHING CHARACTERISTICS (T<sub>A</sub> = +25°C)

Symbol	Characteristic	Condition	Min	Typ	Max	Unit
V <sub>OLP</sub>	Dynamic LOW Peak Voltage (Note 3)	V <sub>CC</sub> = 3.3 V, C <sub>L</sub> = 50 pF, V <sub>IH</sub> = 3.3 V, V <sub>IL</sub> = 0 V V <sub>CC</sub> = 2.5 V, C <sub>L</sub> = 30 pF, V <sub>IH</sub> = 2.5 V, V <sub>IL</sub> = 0 V		0.9 0.7		V
V <sub>OLV</sub>	Dynamic LOW Valley Voltage (Note 3)	V <sub>CC</sub> = 3.3 V, C <sub>L</sub> = 50 pF, V <sub>IH</sub> = 3.3 V, V <sub>IL</sub> = 0 V V <sub>CC</sub> = 2.5 V, C <sub>L</sub> = 30 pF, V <sub>IH</sub> = 2.5 V, V <sub>IL</sub> = 0 V		-0.8 -0.6		V

3. Number of outputs defined as "n". Measured with "n-1" outputs switching from HIGH-to-LOW or LOW-to-HIGH. The remaining output is measured in the LOW state.

# MC74LCX06

## CAPACITIVE CHARACTERISTICS

Symbol	Parameter	Condition	Typical	Unit
$C_{IN}$	Input Capacitance	$V_{CC} = 3.3\text{ V}$ , $V_I = 0\text{ V}$ or $V_{CC}$	7	pF
$C_{OUT}$	Output Capacitance	$V_{CC} = 3.3\text{ V}$ , $V_I = 0\text{ V}$ or $V_{CC}$	8	pF
$C_{PD}$	Power Dissipation Capacitance	10 MHz, $V_{CC} = 3.3\text{ V}$ , $V_I = 0\text{ V}$ or $V_{CC}$	25	pF

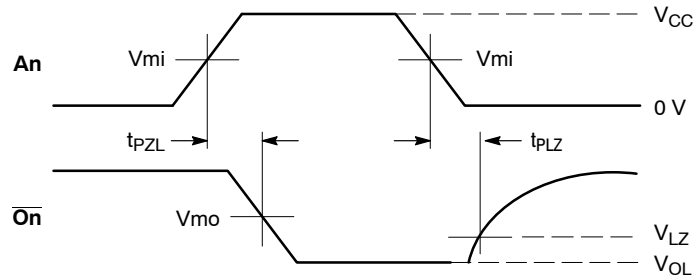

### PROPAGATION DELAYS

$$t_R = t_F = 2.5\text{ ns}, 10\% \text{ to } 90\%; f = 1\text{ MHz}; t_W = 500\text{ ns}$$

Table 3. AC WAVEFORMS

Symbol	$V_{CC}$		
	$3.3\text{ V} \pm 0.3\text{ V}$	$2.7\text{ V}$	$2.5\text{ V} \pm 0.2\text{ V}$
$V_{mi}$	1.5 V	1.5 V	$V_{CC} / 2$
$V_{mo}$	1.5 V	1.5 V	$V_{CC} / 2$
$V_{LZ}$	$V_{OL} + 0.3\text{ V}$	$V_{OL} + 0.3\text{ V}$	$V_{OL} + 0.15\text{ V}$

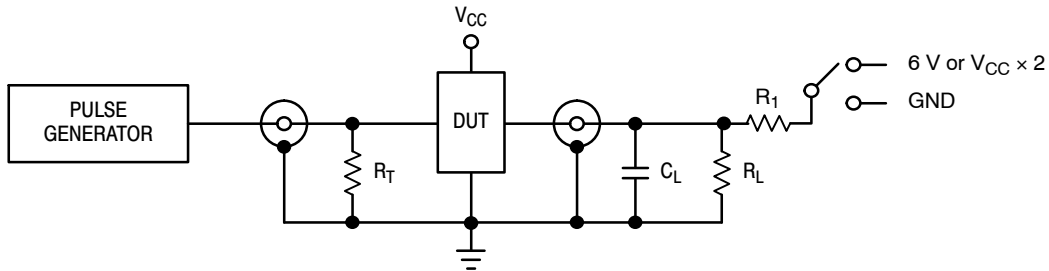

Table 4. TEST CIRCUIT

TEST	SWITCH
$t_{PZL}$ , $t_{PLZ}$	6 V
Open Collector/Drain $t_{PLH}$ and $t_{PHL}$	6 V
$t_{PZH}$ , $t_{PHZ}$	GND

$C_L = 50\text{ pF}$  at  $V_{CC} = 3.3 \pm 0.3\text{ V}$  or equivalent (includes jig and probe capacitance)

$C_L = 30\text{ pF}$  at  $V_{CC} = 2.5 \pm 0.2\text{ V}$  or equivalent (includes jig and probe capacitance)

$R_L = R_1 = 500\ \Omega$  or equivalent

$R_T = Z_{OUT}$  of pulse generator (typically  $50\ \Omega$ )

# MC74LCX06

## PACKAGE DIMENSIONS

TSSOP-14  
DT SUFFIX  
CASE 948G  
ISSUE B

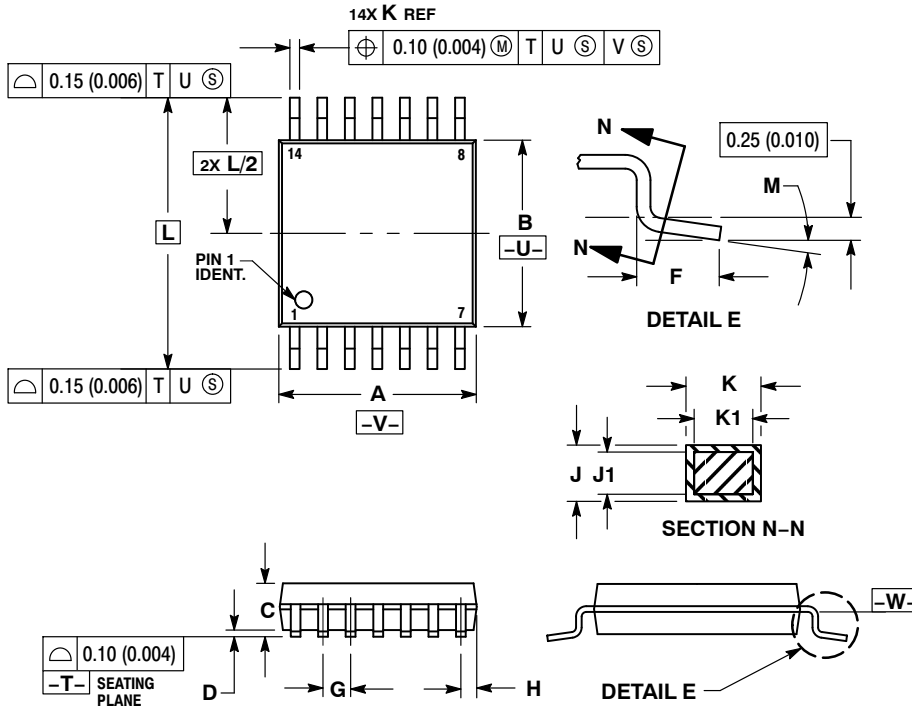

### NOTES:

1. DIMENSIONING AND TOLERANCING PER ANSI Y14.5M, 1982.
2. CONTROLLING DIMENSION: MILLIMETER.
3. DIMENSION A DOES NOT INCLUDE MOLD FLASH, PROTRUSIONS OR GATE BURRS. MOLD FLASH OR GATE BURRS SHALL NOT EXCEED 0.15 (0.006) PER SIDE.
4. DIMENSION B DOES NOT INCLUDE INTERLEAD FLASH OR PROTRUSION. INTERLEAD FLASH OR PROTRUSION SHALL NOT EXCEED 0.25 (0.010) PER SIDE.
5. DIMENSION K DOES NOT INCLUDE DAMBAR PROTRUSION. ALLOWABLE DAMBAR PROTRUSION SHALL BE 0.08 (0.003) TOTAL IN EXCESS OF THE K DIMENSION AT MAXIMUM MATERIAL CONDITION.
6. TERMINAL NUMBERS ARE SHOWN FOR REFERENCE ONLY.
7. DIMENSION A AND B ARE TO BE DETERMINED AT DATUM PLANE -W-.

DIM	MILLIMETERS		INCHES	
	MIN	MAX	MIN	MAX
A	4.90	5.10	0.193	0.200
B	4.30	4.50	0.169	0.177
C	---	1.20	---	0.047
D	0.05	0.15	0.002	0.006
F	0.50	0.75	0.020	0.030
G	0.65 BSC		0.026 BSC	
H	0.50	0.60	0.020	0.024
J	0.09	0.20	0.004	0.008
J1	0.09	0.16	0.004	0.006
K	0.19	0.30	0.007	0.012
K1	0.19	0.25	0.007	0.010
L	6.40 BSC		0.252 BSC	
M	0°	8°	0°	8°

### SOLDERING FOOTPRINT\*

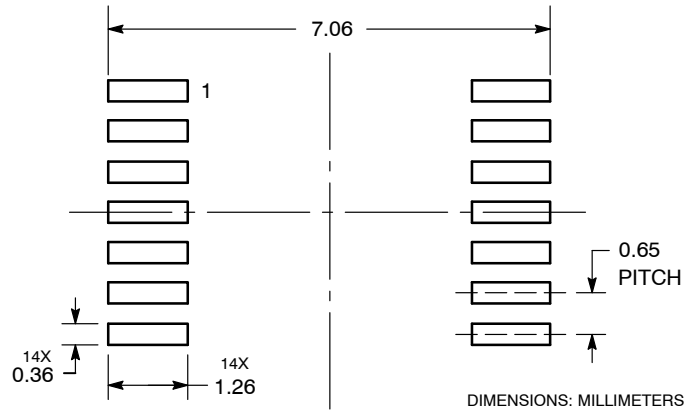

\*For additional information on our Pb-Free strategy and soldering details, please download the ON Semiconductor Soldering and Mounting Techniques Reference Manual, SOLDERRM/D.

# MC74LCX06

## PACKAGE DIMENSIONS

SOIC-14 NB  
CASE 751A-03  
ISSUE K

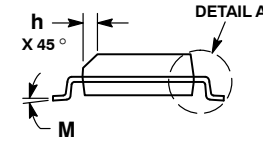
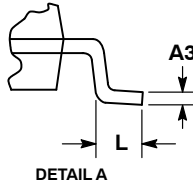
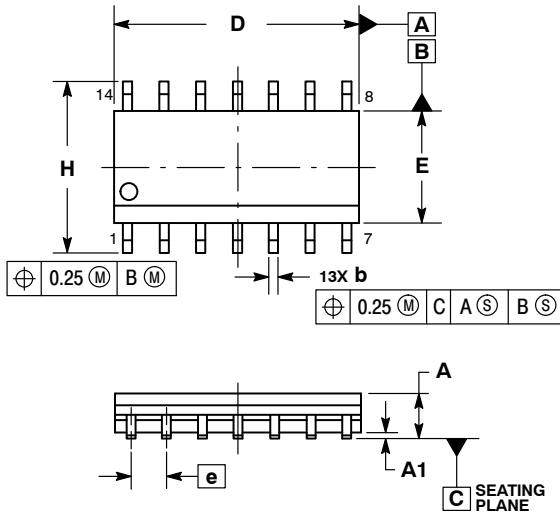

- NOTES:
1. DIMENSIONING AND TOLERANCING PER ASME Y14.5M, 1994.
  2. CONTROLLING DIMENSION: MILLIMETERS.
  3. DIMENSION b DOES NOT INCLUDE DAMBAR PROTRUSION. ALLOWABLE PROTRUSION SHALL BE 0.13 TOTAL IN EXCESS OF AT MAXIMUM MATERIAL CONDITION.
  4. DIMENSIONS D AND E DO NOT INCLUDE MOLD PROTRUSIONS.
  5. MAXIMUM MOLD PROTRUSION 0.15 PER SIDE.

DIM	MILLIMETERS		INCHES	
	MIN	MAX	MIN	MAX
A	1.35	1.75	0.054	0.068
A1	0.10	0.25	0.004	0.010
A3	0.19	0.25	0.008	0.010
b	0.35	0.49	0.014	0.019
D	8.55	8.75	0.337	0.344
E	3.80	4.00	0.150	0.157
e	1.27 BSC		0.050 BSC	
H	5.80	6.20	0.228	0.244
h	0.25	0.50	0.010	0.019
L	0.40	1.25	0.016	0.049
M	0°	7°	0°	7°

### SOLDERING FOOTPRINT\*

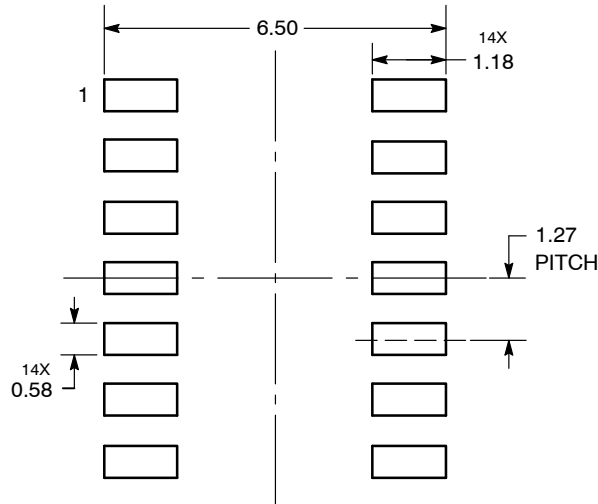

DIMENSIONS: MILLIMETERS

\*For additional information on our Pb-Free strategy and soldering details, please download the ON Semiconductor Soldering and Mounting Techniques Reference Manual, SOLDERRM/D.

ON Semiconductor and are registered trademarks of Semiconductor Components Industries, LLC (SCILLC). SCILLC owns the rights to a number of patents, trademarks, copyrights, trade secrets, and other intellectual property. A listing of SCILLC's product/patent coverage may be accessed at [www.onsemi.com/site/pdf/Patent-Marking.pdf](http://www.onsemi.com/site/pdf/Patent-Marking.pdf). SCILLC reserves the right to make changes without further notice to any products herein. SCILLC makes no warranty, representation or guarantee regarding the suitability of its products for any particular purpose, nor does SCILLC assume any liability arising out of the application or use of any product or circuit, and specifically disclaims any and all liability, including without limitation special, consequential or incidental damages. "Typical" parameters which may be provided in SCILLC data sheets and/or specifications can and do vary in different applications and actual performance may vary over time. All operating parameters, including "Typicals" must be validated for each customer application by customer's technical experts. SCILLC does not convey any license under its patent rights nor the rights of others. SCILLC products are not designed, intended, or authorized for use as components in systems intended for surgical implant into the body, or other applications intended to support or sustain life, or for any other application in which the failure of the SCILLC product could create a situation where personal injury or death may occur. Should Buyer purchase or use SCILLC products for any such unintended or unauthorized application, Buyer shall indemnify and hold SCILLC and its officers, employees, subsidiaries, affiliates, and distributors harmless against all claims, costs, damages, and expenses, and reasonable attorney fees arising out of, directly or indirectly, any claim of personal injury or death associated with such unintended or unauthorized use, even if such claim alleges that SCILLC was negligent regarding the design or manufacture of the part. SCILLC is an Equal Opportunity/Affirmative Action Employer. This literature is subject to all applicable copyright laws and is not for resale in any manner.

### PUBLICATION ORDERING INFORMATION

**LITERATURE FULFILLMENT:**  
Literature Distribution Center for ON Semiconductor  
P.O. Box 5163, Denver, Colorado 80217 USA  
Phone: 303-675-2175 or 800-344-3860 Toll Free USA/Canada  
Fax: 303-675-2176 or 800-344-3867 Toll Free USA/Canada  
Email: [orderlit@onsemi.com](mailto:orderlit@onsemi.com)

**N. American Technical Support:** 800-282-9855 Toll Free  
USA/Canada  
**Europe, Middle East and Africa Technical Support:**  
Phone: 421 33 790 2910  
**Japan Customer Focus Center**  
Phone: 81-3-5817-1050

**ON Semiconductor Website:** [www.onsemi.com](http://www.onsemi.com)  
**Order Literature:** <http://www.onsemi.com/orderlit>  
For additional information, please contact your local Sales Representative



## Стандарт Электрон Связь

Мы молодая и активно развивающаяся компания в области поставок электронных компонентов. Мы поставляем электронные компоненты отечественного и импортного производства напрямую от производителей и с крупнейших складов мира.

Благодаря сотрудничеству с мировыми поставщиками мы осуществляем комплексные и плановые поставки широчайшего спектра электронных компонентов.

Собственная эффективная логистика и склад в обеспечивает надежную поставку продукции в точно указанные сроки по всей России.

Мы осуществляем техническую поддержку нашим клиентам и предпродажную проверку качества продукции. На все поставляемые продукты мы предоставляем гарантию .

Осуществляем поставки продукции под контролем ВП МО РФ на предприятия военно-промышленного комплекса России , а также работаем в рамках 275 ФЗ с открытием отдельных счетов в уполномоченном банке. Система менеджмента качества компании соответствует требованиям ГОСТ ISO 9001.

Минимальные сроки поставки, гибкие цены, неограниченный ассортимент и индивидуальный подход к клиентам являются основой для выстраивания долгосрочного и эффективного сотрудничества с предприятиями радиоэлектронной промышленности, предприятиями ВПК и научно-исследовательскими институтами России.

С нами вы становитесь еще успешнее!

### Наши контакты:

**Телефон:** +7 812 627 14 35

**Электронная почта:** [sales@st-electron.ru](mailto:sales@st-electron.ru)

**Адрес:** 198099, Санкт-Петербург,  
Промышленная ул, дом № 19, литера Н,  
помещение 100-Н Офис 331