

FEATURES

AC PERFORMANCE

500 ns Settling to 0.01% for 10 V Step
 75 V/ μ s Slew Rate
 0.0001% Total Harmonic Distortion (THD)
 13 MHz Gain Bandwidth
 Internal Compensation for Gains of +2 or Greater

DC PERFORMANCE

0.5 mV max Offset Voltage (AD746B)
 10 μ V/ $^{\circ}$ C max Drift (AD746B)
 175 V/mV min Open Loop Gain (AD746B)
 2 μ V p-p Noise, 0.1 Hz to 10 Hz
 Available in Plastic Mini-DIP, Cerdip and Surface Mount Packages
 Available in Tape and Reel in Accordance with EIA-481A Standard
 MIL-STD-883B Processing also Available
 Single Version: AD744

APPLICATIONS

Dual Output Buffers for 12- and 14-Bit DACs
 Input Buffers for Precision ADCs, Wideband Preamplifiers and Low Distortion Audio Circuitry

PRODUCT DESCRIPTION

The AD746 is a dual operational amplifier, consisting of two AD744 BiFET op amps on a single chip. These precision monolithic op amps offer excellent dc characteristics plus rapid settling times, high slew rates and ample bandwidths. In addition, the AD746 provides the close matching ac and dc characteristics inherent to amplifiers sharing the same monolithic die.

The single pole response of the AD746 provides fast settling: 500 ns to 0.01%. This feature, combined with its high dc precision, makes it suitable for use as a buffer amplifier for 12- or 14-bit DACs and ADCs. Furthermore, the AD746's low total harmonic distortion (THD) level of 0.0001% and very close matching ac characteristics make it an ideal amplifier for many demanding audio applications.

The AD746 is internally compensated for stable operation as a unity gain inverter or as a noninverting amplifier with a gain of 2 or greater. It is available in four performance grades. The AD746J is rated over the commercial temperature range of 0 to +70 $^{\circ}$ C. The AD746A and AD746B are rated over the industrial temperature range of -40 $^{\circ}$ C to +85 $^{\circ}$ C. The AD746S is rated over the military temperature range of -55 $^{\circ}$ C to +125 $^{\circ}$ C and is available processed to MIL-STD-883B, Rev. C.

REV. B

Information furnished by Analog Devices is believed to be accurate and reliable. However, no responsibility is assumed by Analog Devices for its use, nor for any infringements of patents or other rights of third parties which may result from its use. No license is granted by implication or otherwise under any patent or patent rights of Analog Devices.

CONNECTION DIAGRAM

Plastic Mini-DIP (N)
 Cerdip (Q) and
 Plastic SOIC (R) Packages

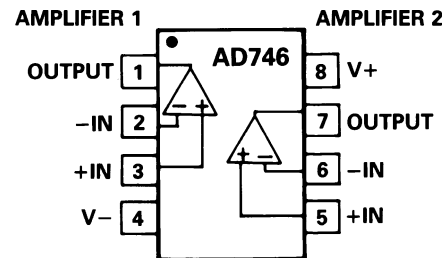

The AD746 is available in three 8-pin packages: plastic mini DIP, hermetic cerdip and surface mount (SOIC).

PRODUCT HIGHLIGHTS

1. The AD746 offers exceptional dynamic response for high speed data acquisition systems. It settles to 0.01% in 500 ns and has a 100% tested minimum slew rate of 50 V/ μ s (AD746B).
2. Outstanding dc precision is provided by a combination of Analog Devices' advanced processing technology, laser wafer drift trimming and well-matched ion-implanted JFETs. Input offset voltage, input bias current and input offset current are specified in the warmed-up condition and are 100% tested.
3. Differential and multichannel systems will benefit from the AD746's very close matching of ac characteristics. Input offset voltage specs are fully tested and guaranteed to a maximum of 0.5 mV (AD746B).
4. The AD746 has very close, guaranteed matching of input bias current between its two amplifiers.
5. Unity gain stable version AD712 also available.

AD746—SPECIFICATIONS (@ +25°C and ±15 V dc, unless otherwise noted)

| Model | Conditions | AD746J/A | | | AD746B | | | AD746S | | | Units | |
|--|---|------------|------------------------------|--------|------------|------------------------------|------|------------|------------------------------|------|----------|-------|
| | | Min | Typ | Max | Min | Typ | Max | Min | Typ | Max | | |
| INPUT OFFSET VOLTAGE ¹ Initial Offset Offset vs. Temperature vs. Supply ² (PSRR) vs. Supply (PSRR) Long Term Stability | T _{MIN} to T _{MAX} | | 0.3 | 1.5 | | 0.25 | 0.5 | | 0.3 | 1.0 | mV | |
| | | | | | | | | | | | | mV |
| | T _{MIN} to T _{MAX} | | 12 | 20 | | 5 | 10 | | 12 | 20 | | μV/°C |
| | | | 80 | 95 | | 84 | 100 | | 80 | 95 | | dB |
| | | 80 | 15 | | 84 | 15 | | 80 | 15 | | dB | |
| | | | | | | | | | | | μV/month | |
| INPUT BIAS CURRENT ³ Either Input Either Input @ T _{MAX} Either Input Offset Current Offset Current @ T _{MAX} | V _{CM} = 0 V | | 110 | 250 | | 110 | 150 | | 110 | 250 | pA | |
| | V _{CM} = 0 V | | 2.5/7 | 5.7/16 | | 7 | 9.6 | | 113 | 256 | nA | |
| | V _{CM} = +10 V | | 145 | 350 | | 145 | 200 | | 145 | 350 | pA | |
| | V _{CM} = 0 V | | 45 | 125 | | 45 | 75 | | 45 | 125 | pA | |
| | V _{CM} = 0 V | | 1.0/3 | 2.8/8 | | 3 | 4.8 | | 45 | 128 | nA | |
| MATCHING CHARACTERISTICS Input Offset Voltage Input Offset Voltage Input Offset Voltage Drift Input Bias Current Crosstalk | T _{MIN} to T _{MAX} | | 0.6 | 1.5 | | 0.3 | 0.5 | | 0.6 | 1.0 | mV | |
| | | | | | | | | | | | | mV |
| | | | | | | | | | | | | μV/°C |
| | @ 1 kHz @ 100 kHz | | 120 | 125 | | 120 | 75 | | 120 | 125 | | pA |
| | | | 90 | | | 90 | | | 90 | | | dB |
| | | | | | | | | | | | dB | |
| FREQUENCY RESPONSE Gain BW, Small Signal Slew Rate, Unity Gain Full Power Response Settling Time to 0.01% ⁴ Total Harmonic Distortion | G = -1 | 8 | 13 | | 9 | 13 | | 8 | 13 | | MHz | |
| | G = -1 | 45 | 75 | | 50 | 75 | | 45 | 75 | | V/μs | |
| | V _O = 20 V p-p | | 600 | | | 600 | | | 600 | | kHz | |
| | G = 1 | | 0.5 | 0.75 | | 0.5 | 0.75 | | 0.5 | 0.75 | μs | |
| | f = 1 kHz R ₁ ≥ 2 kΩ | | | | | | | | | | | % |
| | V _O = 3 V rms | | 0.0001 | | | 0.0001 | | | 0.0001 | | | % |
| INPUT IMPEDANCE Differential Common Mode | | | 2.5 × 10 ¹¹ 5.5 | | | 2.5 × 10 ¹¹ 5.5 | | | 2.5 × 10 ¹¹ 5.5 | | Ω pF | |
| | | | 2.5 × 10 ¹¹ 5.5 | | | 2.5 × 10 ¹¹ 5.5 | | | 2.5 × 10 ¹¹ 5.5 | | Ω pF | |
| INPUT VOLTAGE RANGE Differential ⁵ Common-Mode Voltage Over Max Operating Range ⁶ Common-Mode Rejection Ratio | | | ±20 | | | ±20 | | | ±20 | | V | |
| | | | +14.5, -11.5 | | | +14.5, -11.5 | | | +14.5, -11.5 | | V | |
| | | | | +13 | | +13 | | | +13 | | V | |
| | V _{CM} = ±10 V | -11 | 78 | 88 | -11 | 82 | 88 | -11 | 78 | 88 | dB | |
| | T _{MIN} to T _{MAX} | 76 | 84 | | 80 | 84 | | 76 | 84 | | dB | |
| | V _{CM} = ±11 V | 72 | 84 | | 78 | 84 | | 72 | 84 | | dB | |
| | T _{MIN} to T _{MAX} | 70 | 80 | | 74 | 80 | | 70 | 80 | | dB | |
| INPUT VOLTAGE NOISE | 0.1 to 10 Hz | | 2 | | | 2 | | | 2 | | μV p-p | |
| | f = 10 Hz | | 45 | | | 45 | | | 45 | | nV/√Hz | |
| | f = 100 Hz | | 22 | | | 22 | | | 22 | | nV/√Hz | |
| | f = 1 kHz | | 18 | | | 18 | | | 18 | | nV/√Hz | |
| | f = 10 kHz | | 16 | | | 16 | | | 16 | | nV/√Hz | |
| INPUT CURRENT NOISE | f = 1 kHz | | 0.01 | | | 0.01 | | | 0.01 | | pA/√Hz | |
| OPEN LOOP GAIN | V _O = ±10 V | | | | | | | | | | V/mV | |
| | R ₁ ≥ 2 kΩ T _{MIN} to T _{MAX} | 150 | 300 | | 175 | 300 | | 150 | 300 | | V/mV | |
| | | 75 | 200 | | 75 | 200 | | 65 | 175 | | V/mV | |
| OUTPUT CHARACTERISTICS Voltage Current Max Capacitive Load Driving Capability | R ₁ ≥ 2 kΩ | +13, -12.5 | +13.9, -13.3 | | +13, -12.5 | +13.9, -13.3 | | +13, -12.5 | +13.9, -13.3 | | V | |
| | T _{MIN} to T _{MAX} | ±12 | +13.8, -13.1 | | ±12 | +13.8, -13.1 | | ±12 | +13.8, -13.1 | | V | |
| | Short Circuit | | 25 | | | 25 | | | 25 | | mA | |
| | Gain = -1 | | 50 | | | 50 | | | 50 | | pF | |
| | Gain = -10 | | 500 | | | 500 | | | 500 | | pF | |
| POWER SUPPLY Rated Performance Operating Range Quiescent Current | | | ±15 | | | ±15 | | | ±15 | | V | |
| | | ±4.5 | | ±18 | ±4.5 | | ±18 | ±4.5 | | ±18 | V | |
| | | | 7 | 10 | | 7 | 8.0 | | 7 | 10 | mA | |
| TEMPERATURE RANGE Rated Performance | | | 0 to +70/-40 to +85 | | | -40 to +85 | | | -55 to +125 | | °C | |
| PACKAGE OPTIONS 8-Pin Plastic Mini-DIP (N-8) 8-Pin Cerdip (Q-8) 8-Pin Surface Mount (R-8) Tape and Reel Chips | | | AD746JN | | | AD746BQ | | | AD746SQ | | | |
| | | | AD746AQ | | | | | | | | | |
| | | | AD746JR | | | | | | | | | |
| | | | AD746JR-REEL | | | | | | AD746SCHIPS | | | |
| TRANSISTOR COUNT | | | 54 | | | 54 | | | 54 | | | |

NOTES

- ¹Input Offset Voltage specifications are guaranteed after 5 minutes of operation at $T_A = +25^\circ\text{C}$.
 - ²PSRR test conditions: $+V_S = 15\text{ V}$, $-V_S = -12\text{ V}$ to -18 V and $+V_S = 12\text{ V}$ to 18 V , $-V_S = -15\text{ V}$.
 - ³Bias Current Specifications are guaranteed maximum at either input after 5 minutes of operation at $T_A = +25^\circ\text{C}$. For higher temperature, the current doubles every 10°C .
 - ⁴Gain = -1, $R_I = 2\text{ k}$, $C_I = 10\text{ pF}$.
 - ⁵Defined as voltage between inputs, such that neither exceeds $\pm 10\text{ V}$ from ground.
 - ⁶Typically exceeding -14.1 V negative common-mode voltage on either input results in an output phase reversal.
- Specifications subject to change without notice.

Specifications in **boldface** are tested on all production units at final electrical test. Results from those tests are used to calculate outgoing quality levels. All min and max specifications are guaranteed, although only those shown in **boldface** are tested on all production units.

ABSOLUTE MAXIMUM RATINGS¹

| | |
|--|---|
| Supply Voltage | $\pm 18\text{ V}$ |
| Internal Power Dissipation ² | 500 mW |
| Input Voltage | $\pm V_S$ |
| Output Short Circuit Duration (For One Amplifier) | Indefinite |
| Differential Input Voltage | $+V_S$ and $-V_S$ |
| Storage Temperature Range (Q) | -65°C to $+150^\circ\text{C}$ |
| Storage Temperature Range (N, R) | -65°C to $+125^\circ\text{C}$ |
| Operating Temperature Range | |
| AD746J | 0°C to $+70^\circ\text{C}$ |
| AD746A/B | -40°C to $+85^\circ\text{C}$ |
| AD746S | -55°C to $+125^\circ\text{C}$ |

| | |
|--|----------------------|
| Lead Temperature Range (Soldering 60 seconds) | $+300^\circ\text{C}$ |
| ESD Rating | |

- NOTES**
- ¹Stresses above those listed under "Absolute Maximum Ratings" may cause permanent damage to the device. This is a stress rating only and functional operation of the device at these or any other conditions above those indicated in the operational section of this specification is not implied. Exposure to absolute maximum rating conditions for extended periods may affect device reliability.
 - ²8-Pin Plastic Package: $\theta_{JA} = 100^\circ\text{C/Watt}$, $\theta_{JC} = 50^\circ\text{C/Watt}$
 - 8-Pin Cerdip Package: $\theta_{JA} = 110^\circ\text{C/Watt}$, $\theta_{JC} = 30^\circ\text{C/Watt}$
 - 8-Pin Small Outline Package: $\theta_{JA} = 160^\circ\text{C/Watt}$, $\theta_{JC} = 42^\circ\text{C/Watt}$

METALIZATION PHOTOGRAPH

Contact factory for latest dimensions.
Dimensions shown in inches and (mm).

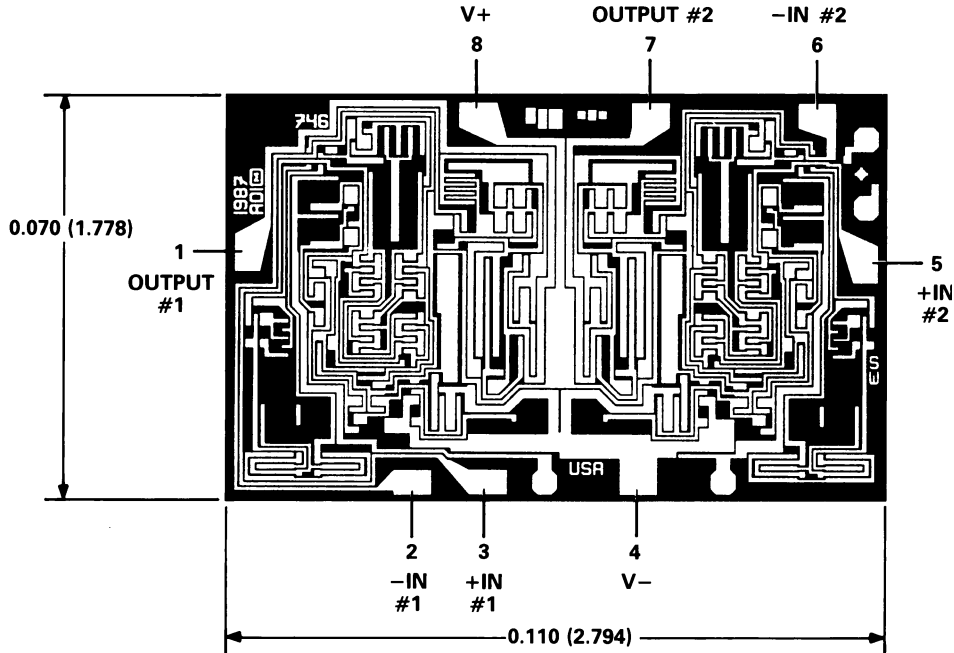

CAUTION

ESD (electrostatic discharge) sensitive device. Electrostatic charges as high as 4000 V readily accumulate on the human body and test equipment and can discharge without detection. Although the AD746 features proprietary ESD protection circuitry, permanent damage may occur on devices subjected to high energy electrostatic discharges. Therefore, proper ESD precautions are recommended to avoid performance degradation or loss of functionality.



AD746—Typical Characteristics

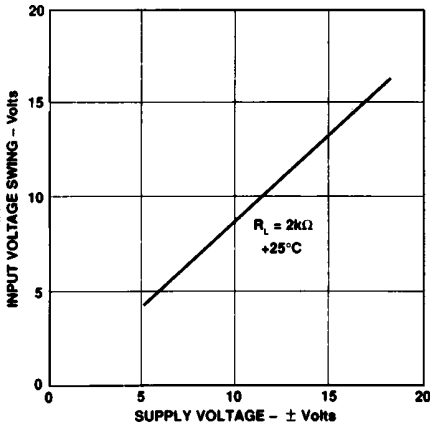

Figure 1. Input Voltage Swing vs. Supply Voltage

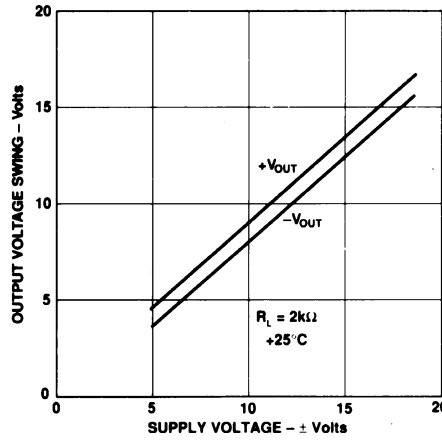

Figure 2. Output Voltage Swing vs. Supply Voltage

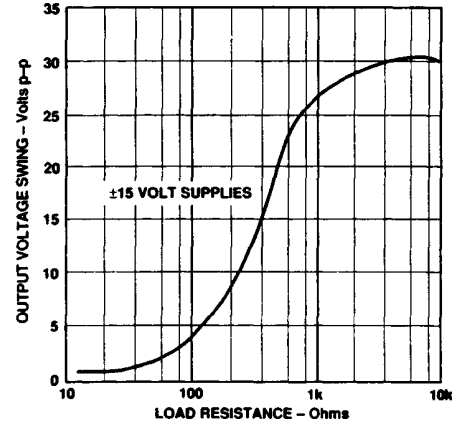

Figure 3. Output Voltage Swing vs. Load Resistance

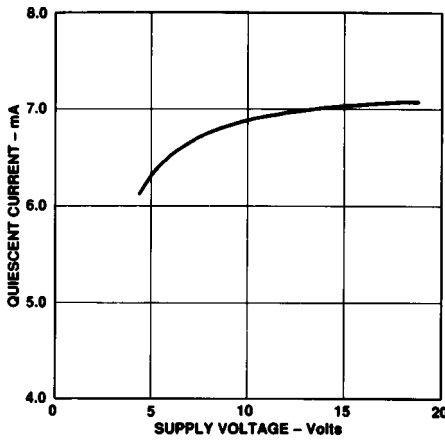

Figure 4. Quiescent Current vs. Supply Voltage

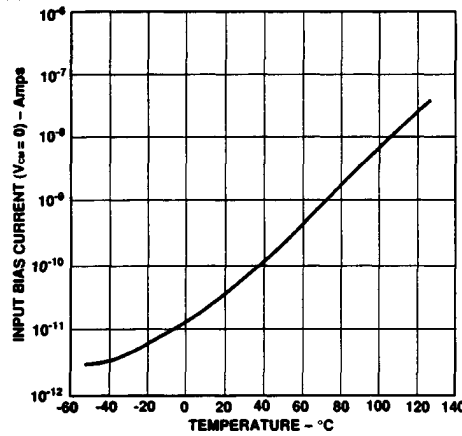

Figure 5. Input Bias Current vs. Temperature

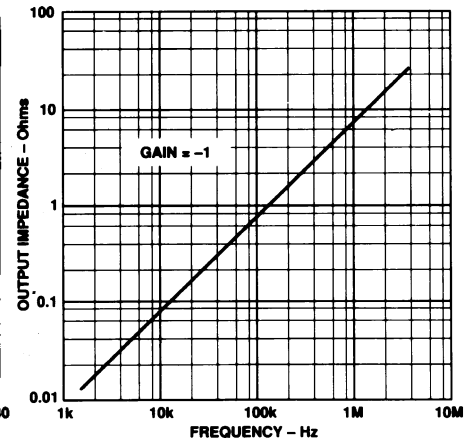

Figure 6. Output Impedance vs. Frequency

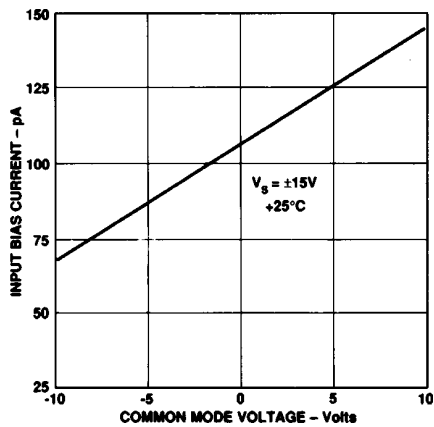

Figure 7. Input Bias Current vs. Common Mode Voltage

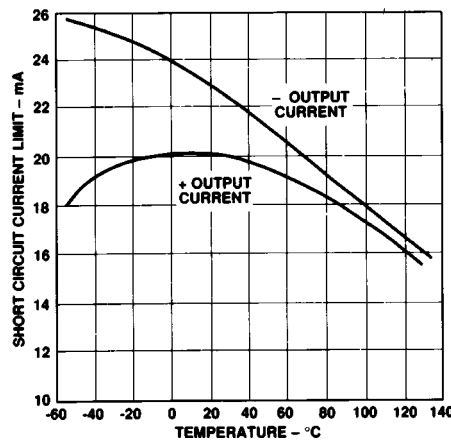

Figure 8. Short Circuit Current Limit vs. Temperature

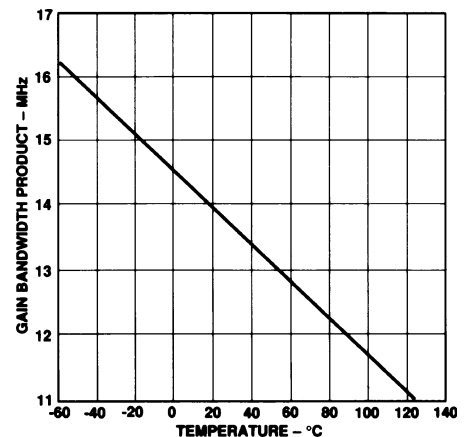

Figure 9. Gain Bandwidth Product vs. Temperature

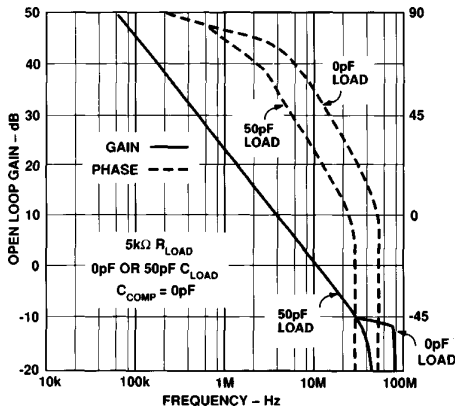

Figure 10. Open Loop Gain and Phase Margin vs. Frequency

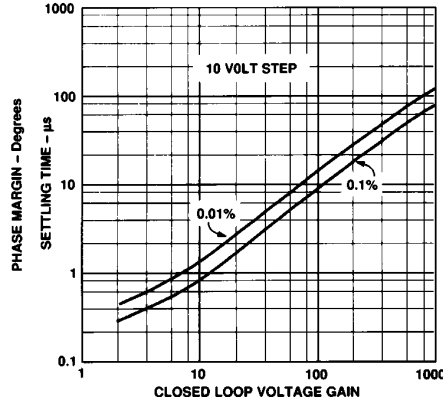

Figure 11. Settling Time vs. Closed Loop Voltage Gain

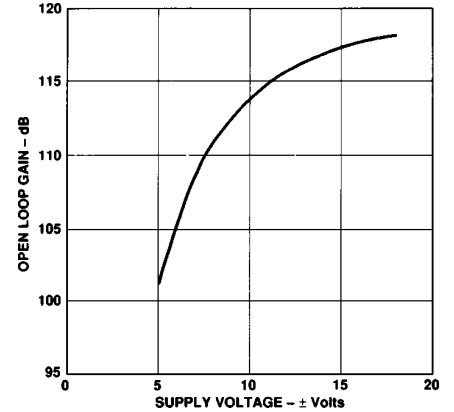

Figure 12. Open Loop Gain vs. Supply Voltage

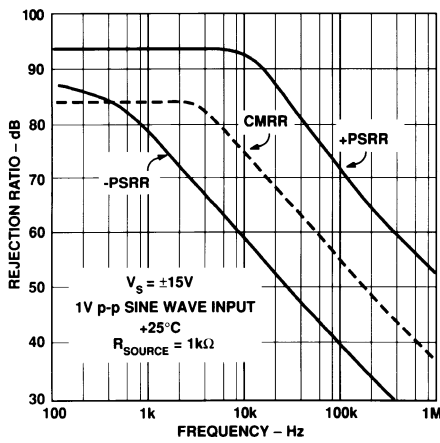

Figure 13. Common-Mode and Power Supply Rejection vs. Frequency

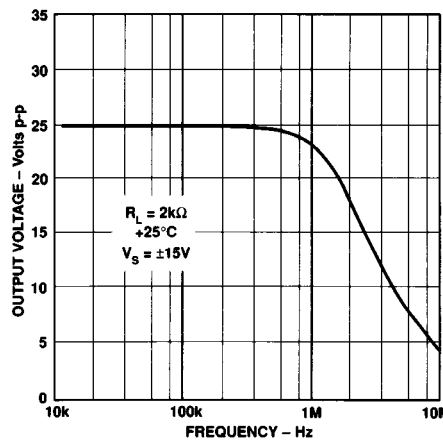

Figure 14. Large Signal Frequency Response

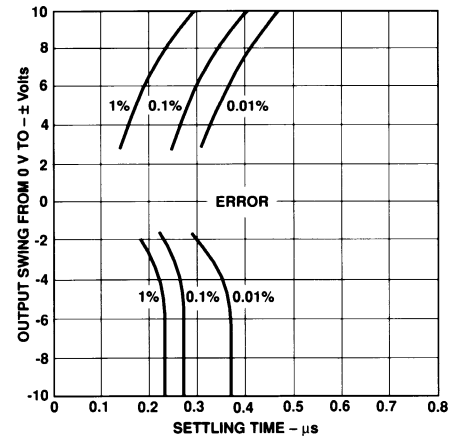

Figure 15. Output Swing and Error vs. Settling Time

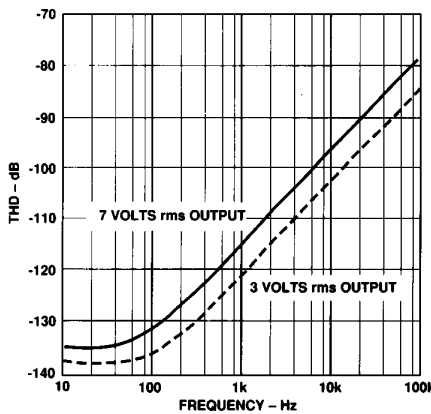

Figure 16. Total Harmonic Distortion vs. Frequency Using Circuit of Figure 19

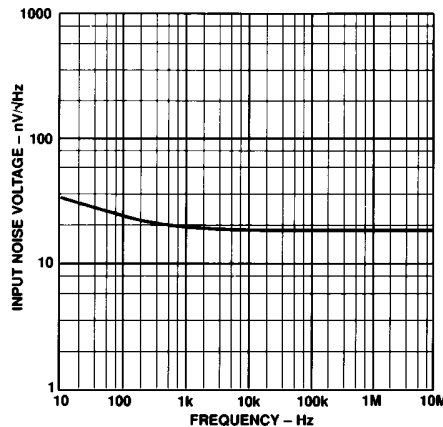

Figure 17. Input Noise Voltage Spectral Density

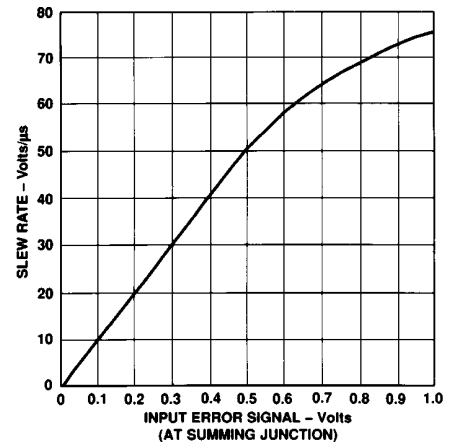

Figure 18. Slew Rate vs. Input Error Signal

AD746

POWER SUPPLY BYPASSING

The power supply connections to the AD746 must maintain a low impedance to ground over a bandwidth of 13 MHz or more. This is especially important when driving a significant resistive or capacitive load, since all current delivered to the load comes from the power supplies. Multiple high quality bypass capacitors are recommended for each power supply line in any critical application. A 0.1 μF ceramic and a 1 μF tantalum capacitor as shown in Figure 20 placed as close as possible to the amplifier

(with short lead lengths to power supply common) will assure adequate high frequency bypassing, in most applications. A minimum bypass capacitance of 0.1 μF should be used for any application.

If only one of the two amplifiers inside the AD746 is to be utilized, the unused amplifier should be connected as shown in Figure 21a. Note that the noninverting input should be grounded and that R_L and C_L are not required.

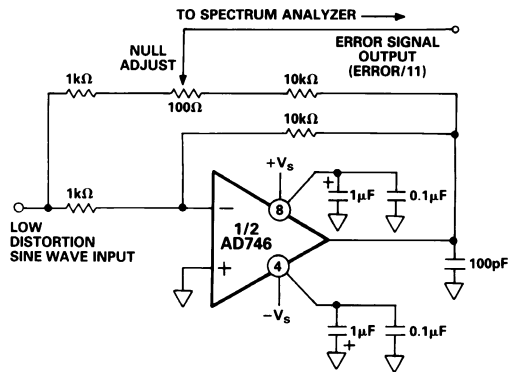

Figure 19. THD Test Circuit

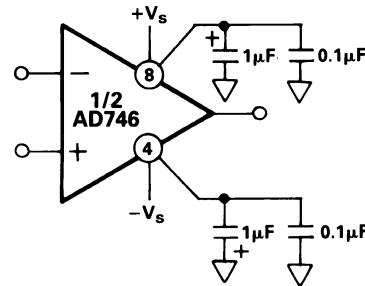

Figure 20. Power Supply Bypassing

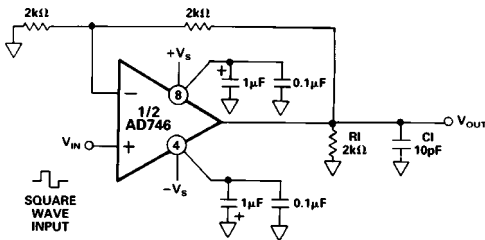

Figure 21a. Gain of 2 Follower

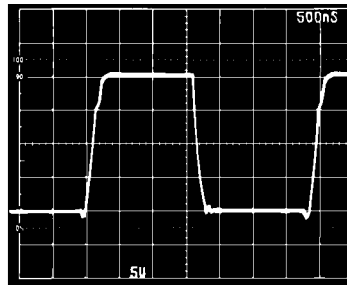

Figure 21b. Gain of 2 Follower Large Signal Pulse Response

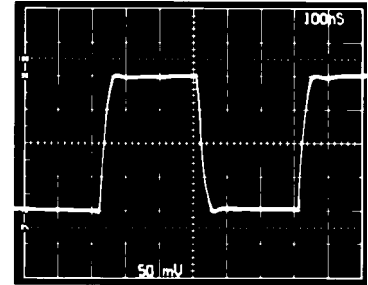

Figure 21c. Gain of 2 Follower Small Signal Pulse Response

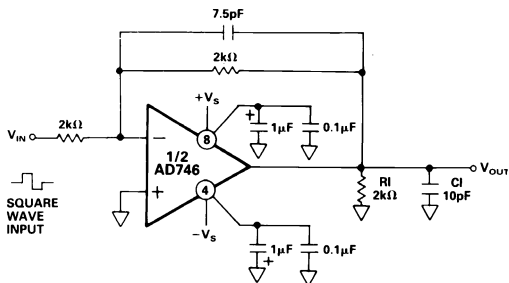

Figure 22a. Unity Gain Inverter

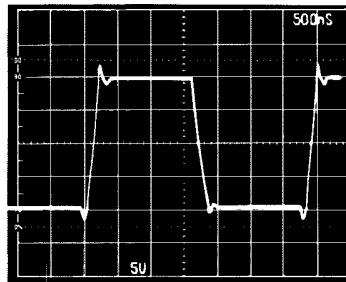

Figure 22b. Unity Gain Inverter Large Signal Pulse Response

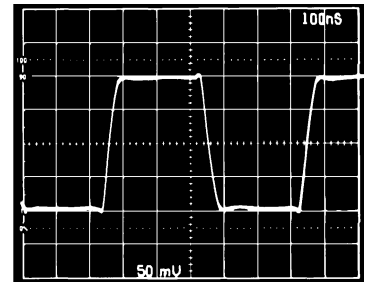
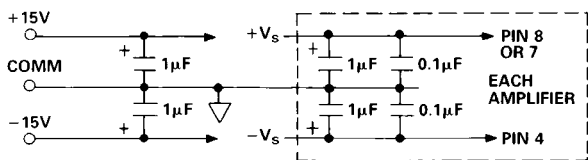
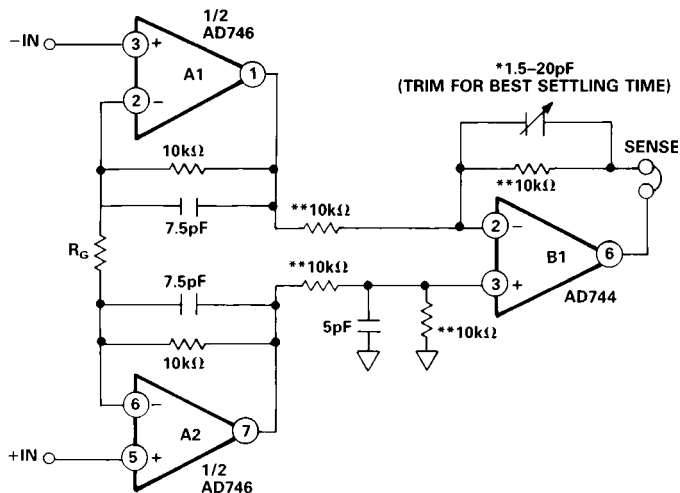

Figure 22c. Unity Gain Inverter Small Signal Pulse Response

A HIGH SPEED 3 OP AMP INSTRUMENTATION AMPLIFIER CIRCUIT

The instrumentation amplifier circuit shown in Figure 23 can provide a range of gains from 2 up to 1000 and higher. The circuit bandwidth is 2.5 MHz at a gain of 2 and 750 kHz at a gain of 10; settling time for the entire circuit is less than 2 μs to within 0.01% for a 10 volt step, (G = 10).

$$\text{CIRCUIT GAIN} = \frac{20,000}{R_G} + 1$$



*VOLTRONICS SP20 TRIMMER CAPACITOR OR EQUIVALENT
 **RATIO MATCHED 1% METAL FILM RESISTORS

Figure 23. A High Performance, 3 Op Amp, Instrumentation Amplifier Circuit

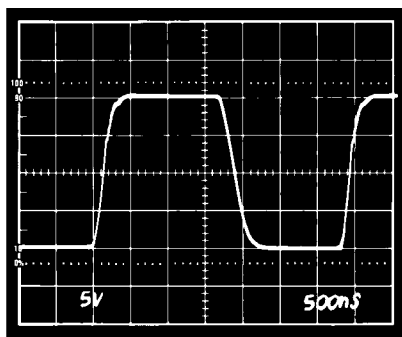

Figure 24. Pulse Response of the 3 Op Amp Instrumentation Amplifier. Gain = 10, Horizontal Scale: 0.5 μs/Div, Vertical Scale: 5 V/Div.

Table I. Performance Summary for the 3 Op Amp Instrumentation Amplifier Circuit

| Gain | R _G | Bandwidth | T _{SETTLE} (0.01%) |
|------|----------------|-----------|-----------------------------|
| 2 | 20 kΩ | 2.5 MHz | 1.0 μs |
| 10 | 4.04 kΩ | 1 MHz | 2.0 μs |
| 100 | 404 Ω | 290 kHz | 5.0 μs |

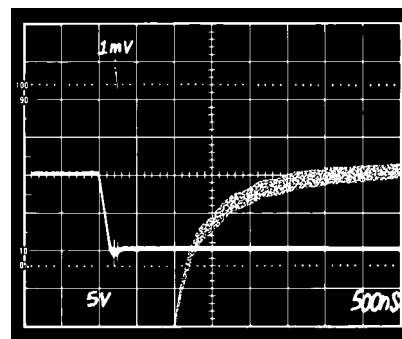

Figure 25. Settling Time of the 3 Op Amp Instrumentation Amplifier. Gain = 10, Horizontal Scale: 0.5 μs/Div, Vertical Scale: 5 V/Div. Error Signal Scale: 0.01%/Div.

THD Performance Considerations

The AD746 was carefully optimized to offer excellent performance in terms of total harmonic distortion (THD) in signal processing applications. The THD level when operating the AD746 in inverting gain applications will show a gradual rise from the distortion floor of 20 dB/decade (see Figure 28). In noninverting applications, care should be taken to balance the source impedances at both the inverting and noninverting inputs, to avoid distortion caused by the modulation of input capacitance inherent in all BiFET op amps.

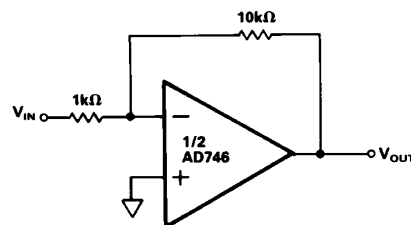

Figure 26. THD Measurement, Inverter Circuit

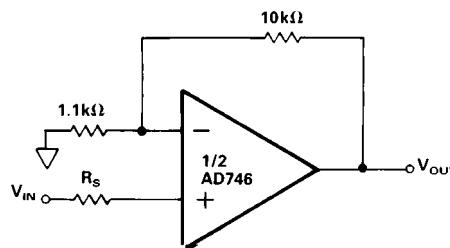

Figure 27. THD Measurement, Follower Circuit

AD746

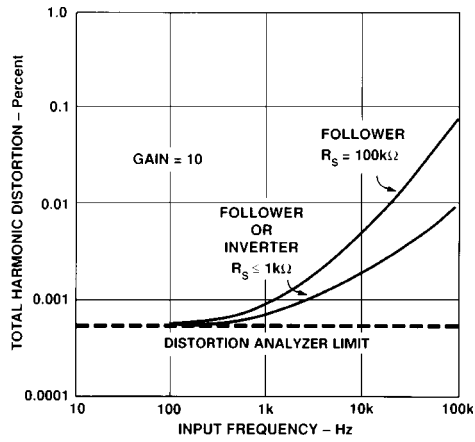

Figure 28. THD vs. Frequency Using Standard Distortion Analyzer

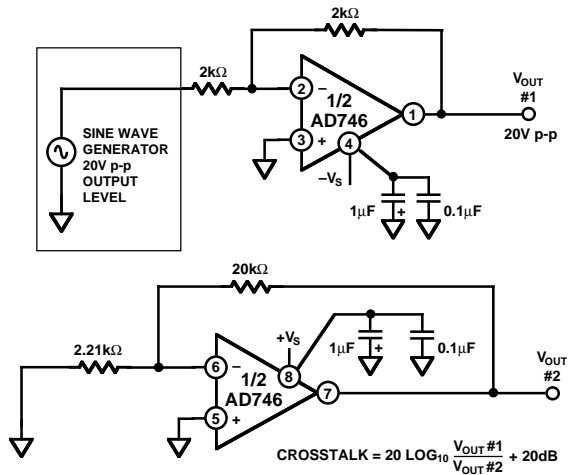

Figure 29. Crosstalk Test Circuit

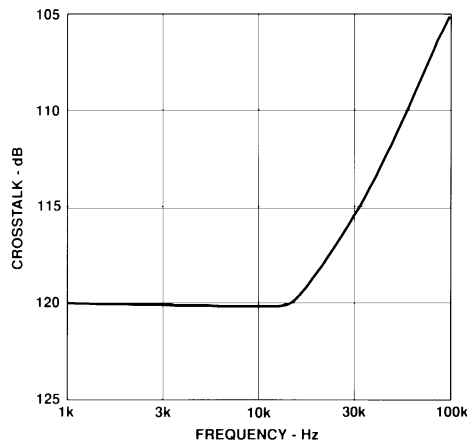
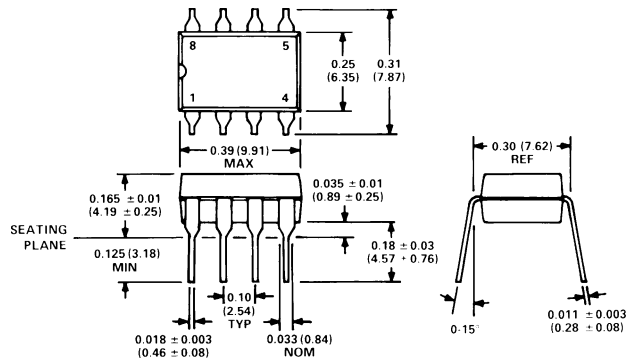

Figure 30. Crosstalk vs. Frequency

OUTLINE DIMENSIONS

Dimensions shown in inches and (mm).

Mini-DIP (N) Package



Cerdip (Q) Package

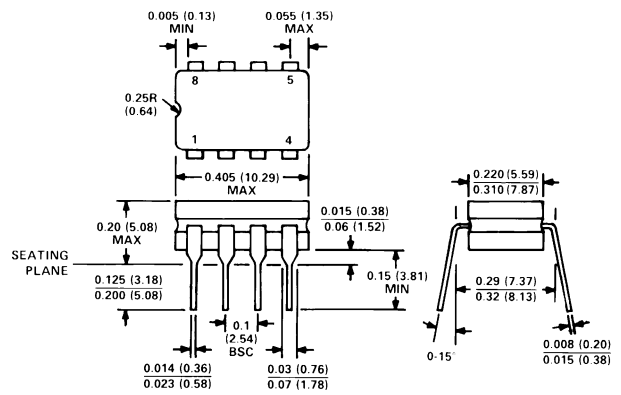

Plastic Small Outline (R) Package

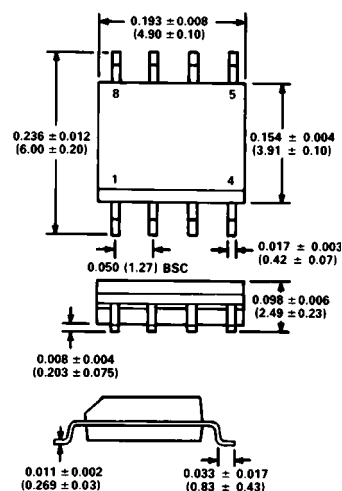

C1319-10-9/89

PRINTED IN U.S.A.



Стандарт Электрон Связь

Мы молодая и активно развивающаяся компания в области поставок электронных компонентов. Мы поставляем электронные компоненты отечественного и импортного производства напрямую от производителей и с крупнейших складов мира.

Благодаря сотрудничеству с мировыми поставщиками мы осуществляем комплексные и плановые поставки широчайшего спектра электронных компонентов.

Собственная эффективная логистика и склад в обеспечивает надежную поставку продукции в точно указанные сроки по всей России.

Мы осуществляем техническую поддержку нашим клиентам и предпродажную проверку качества продукции. На все поставляемые продукты мы предоставляем гарантию .

Осуществляем поставки продукции под контролем ВП МО РФ на предприятия военно-промышленного комплекса России , а также работаем в рамках 275 ФЗ с открытием отдельных счетов в уполномоченном банке. Система менеджмента качества компании соответствует требованиям ГОСТ ISO 9001.

Минимальные сроки поставки, гибкие цены, неограниченный ассортимент и индивидуальный подход к клиентам являются основой для выстраивания долгосрочного и эффективного сотрудничества с предприятиями радиоэлектронной промышленности, предприятиями ВПК и научно-исследовательскими институтами России.

С нами вы становитесь еще успешнее!

Наши контакты:

Телефон: +7 812 627 14 35

Электронная почта: sales@st-electron.ru

Адрес: 198099, Санкт-Петербург,
Промышленная ул, дом № 19, литера Н,
помещение 100-Н Офис 331