



Si8920 Data Sheet

Isolated Amplifier for Current Shunt Measurement

The Si8920 is a galvanically isolated analog amplifier. The low-voltage differential input is ideal for measuring voltage across a current shunt resistor or for any place where a sensor must be isolated from the control system. The output is a differential analog signal amplified by either 8.1x or 16.2x.

The very low signal delay of the Si8920 allows control systems to respond quickly to fault conditions or changes in load. Low offset and gain drift ensure that accuracy is maintained over the entire operating temperature range. Exceptionally high common-mode transient immunity means that the Si8920 delivers accurate measurements even in the presence of high-power switching as is found in motor drive systems and inverters.

The Si8920 isolated amplifier utilizes Silicon Labs' proprietary isolation technology. It supports up to 5.0 kVrms withstand voltage per UL1577. This technology enables higher performance, reduced variation with temperature and age, tighter part-to-part matching, and longer lifetimes compared to other isolation technologies.

Automotive Grade is available for certain part numbers. These products are built using automotive-specific flows at all steps in the manufacturing process to ensure the robustness and low defectivity required for automotive applications.

Industrial Applications

- Industrial and renewable energy inverters
- AC, Brushless, and DC motor controls and drives
- Variable speed motor control in consumer white goods
- Isolated switch mode and UPS power supplies

Automotive Applications

- Hybrid and EV traction inverters
- Onboard chargers
- Charging pedestals

Safety Regulatory Approvals

- UL 1577 recognized
 - Up to 5000 Vrms for 1 minute
- CSA component notice 5A approval
 - IEC 60950-1 (reinforced insulation)
- VDE certification conformity
 - VDE0884 Part 10 (basic/reinforced insulation)
- CQC certification approval
 - GB4943.1

KEY FEATURES

- Low voltage differential input
 - ± 100 mV and ± 200 mV options
- Low signal delay: 0.75 μ s
- Input offset: 0.2 mV
- Gain error: <0.5%
- Excellent drift specifications
 - 1 μ V/ $^{\circ}$ C offset drift
 - 10 ppm/ $^{\circ}$ C gain drift
- Nonlinearity: 0.025% full-scale
- Low noise: 0.10 mVrms over 100 kHz bandwidth
- High common-mode transient immunity: 75 kV/ μ s
- Compact packages
 - 16-pin wide body SOIC
 - 8-pin surface mount DIP
- -40 to 125 $^{\circ}$ C
- AEC-Q100
- Automotive-grade OPNs available
 - AIAG compliant PPAP documentation support
 - IMDS and CAMDS listing support

1. Ordering Guide

Table 1.1. Ordering Guide for Valid OPNs

New Ordering Part Number (OPN)	Ordering Options		
	Specified Input Range	Isolation Rating	Package Type
Si8920AC-IP	±100 mV	3.75 kVrms	Gull-wing DIP-8
Si8920BC-IP	±200 mV	3.75 kVrms	Gull-wing DIP-8
Si8920AD-IS	±100 mV	5.0 kVrms	WB SOIC-16
Si8920BD-IS	±200 mV	5.0 kVrms	WB SOIC-16
Si8920AC-IS	±100 mV	3.75 kVrms	WB SOIC-16
Si8920BC-IS	±200 mV	3.75 kVrms	WB SOIC-16

Note:

1. All packages are RoHS-compliant.
2. "Si" and "SI" are used interchangeably.

Automotive Grade OPNs

Automotive-grade devices are built using automotive-specific flows at all steps in the manufacturing process to ensure robustness and low defectivity. These devices are supported with AIAG-compliant Production Part Approval Process (PPAP) documentation, and feature International Material Data System (IMDS) and China Automotive Material Data System (CAMDS) listing. Qualifications are compliant with AEC-Q100, and a zero-defect methodology is maintained throughout definition, design, evaluation, qualification, and mass production steps.

Table 1.2. Ordering Guide for Automotive Grade OPNs^{1, 2, 4, 5}

New Ordering Part Number (OPN)	Ordering Options		
	Specified Input Range	Isolation Rating	Package Type
Si8920BC-AP	±200 mV	3.75 kVrms	Gull-wing DIP-8

Note:

1. All packages are RoHS-compliant.
2. "Si" and "SI" are used interchangeably.
3. An "R" at the end of the part number denotes tape and reel packaging option.
4. Automotive-Grade devices (with an "-A" suffix) are identical in construction materials, topside marking, and electrical parameters to their Industrial-Grade (with a "-I" suffix) version counterparts. Automotive-Grade products are produced utilizing full automotive process flows and additional statistical process controls throughout the manufacturing flow. The Automotive-Grade part number is included on shipping labels.
5. Additional Ordering Part Numbers may be available in Automotive-Grade. Please contact your local Silicon Labs sales representative for further information.
6. In Section 6.5 [Top Marking: DIP8](#) and Section 6.6 [Top Marking: 16-Pin Wide Body SOIC](#), the Manufacturing Code represented by either "RTTTTT" or "TTTTTT" contains as its first character a letter in the range N through Z to indicate Automotive-Grade."

Table of Contents

1. Ordering Guide	2
2. System Overview	4
3. Current Sense Application	5
4. Electrical Specifications	6
4.1 Typical Operating Characteristics	.11
4.2 Regulatory Information	.13
5. Pin Descriptions	15
6. Packaging	16
6.1 Package Outline: DIP8	.16
6.2 Land Pattern: DIP8	.17
6.3 Package Outline: 16-Pin Wide Body SOIC	.18
6.4 Land Pattern: 16-Pin Wide Body SOIC	.20
6.5 Top Marking: DIP8	.21
6.6 Top Marking: 16-Pin Wide Body SOIC	.22
7. Revision History	23

2. System Overview

The input to the Si8920 is designed for low-voltage, differential signals. This is ideal for connection to low resistance current shunt measurement resistors. The Si8920A has a full scale input range of ± 100 mV, and the Si8920B has a full scale input range of ± 200 mV. In both cases, the internal gain is set so that the full scale output is 1.6 V.

The Si8920 modulates the analog signal in a unique way for transmission across the semiconductor based isolation barrier. The input signal is first converted to a pulse-width modulated digital signal. For transmission across the isolation barrier, the signal is further modulated with a high frequency carrier. On the other side of the isolation barrier, the signal is demodulated and the carrier portion is removed. The resulting PWM signal is then used to faithfully reproduce the analog signal. This solution provides exceptional signal bandwidth and accuracy.



Figure 2.1. Functional Block Diagram

3. Current Sense Application

In the driver circuit presented below, the Si8920 is used to amplify the voltage across the sense resistor, RSENSE, and transmit the analog signal to the low-voltage domain across an isolation barrier. Isolation is needed because the voltage of RSENSE with respect to ground will swing between 0 V and the high voltage rail connected to the drain of Q1.



Figure 3.1. Current Sense Application

The load in this application can be a motor winding or a similar inductive winding. In a three-phase motor drive application, this circuit would be repeated three times, one for each phase. RSENSE should be a small resistor value to reduce power loss. However, an excessively low resistance will reduce the signal-to-noise ratio of the measurement. Si8920 offers two specified full-scale input options, ± 100 mV (Si8920A) and ± 200 mV (Si8920B), for optimizing the value of RSENSE.

AIP and AIN connections to the RSENSE resistor should be made as close as possible to each end of the RSENSE resistor as trace resistance will add error to the measurement. The input to the Si8920 is differential, and the PCB traces back to the input pins should run in parallel. This ensures that any large noise transients that occur on the high-voltage side are coupled equally to the AIP and AIN pins and will be rejected by the Si8920 as a common-mode signal.

The amplifier bandwidth of the Si8920 is approximately 950 kHz. If further input filtering is required, a passive, differential RC low-pass filter can be placed between RSENSE and the input pins. Values of $R1 = R2 = 20 \Omega$ and $C1 = 10$ nF, as shown in [Figure 4.8 Step Response Low to High on page 11](#), provides a cutoff at approximately 400 kHz. For the lowest gain error, R1 and R2 should always be less than 33Ω to keep the source impedance sufficiently low compared to the Si8920 input impedance.

The common-mode voltage of AIN and AIP must be greater than -0.2 V but less than 1 V with respect to GNDA. To meet this requirement, connect GNDA of the Si8920 to one side of the RSENSE resistor. In this example, GNDA, RSENSE, the source of Q1, and the drain of Q2 are connected. The ground of the gate driver (Silicon Labs' Si8234 in this circuit) is also commonly connected to the same node.

The Q1 gate driver has a floating supply, 24 V in this example. Since the input and output of the Si8920 are galvanically isolated from each other, separate power supplies are necessary on each side. Q3, R3, C3, and D1 make a regulator circuit for powering the input side of the Si8920 from this floating supply. D1 establishes a voltage of 5.6 V at the base of Q3. R3 is selected to provide a Zener current of 10 mA for D1. C3 provides filtering at the base of Q3, and the emitter output of Q3 provides approximately 5 V to VDDA. C2 is a bypass capacitor for the supply and should be placed at the VDDA pin with its return trace connecting to the GNDA connection at RSENSE.

C4, the local bypass capacitor for the B-side of Si8920, should be placed closed to VDDB supply pin with its return close to GNDB. The output signal at AOP and AON is differential with a nominal gain of 8.1 (Si8920B) or 16.2 (Si8920A) and common mode of 1.1 V. The outputs are sampled by a differential input ADC. Depending on the sample rate of the ADC, an anti-aliasing filter may be required. A simple anti-aliasing filter can be made from the passive components, R4, C6, and R5. The characteristics of this filter are dictated by the input topology and sampling frequency of the ADC. However, to ensure the Si8920 outputs are not overloaded, $R4 = R5 > 5$ k Ω and C6 can be calculated by the following equation:

$$C6 = \frac{1}{2 \times \pi \times (R4 + R5) \times f_{3dB}}$$

4. Electrical Specifications

Table 4.1. Electrical Specifications

$V_{DDA}, V_{DDB} = 5\text{ V}$, $T_A = -40\text{ to }+125\text{ }^\circ\text{C}$; typical specs at $25\text{ }^\circ\text{C}$

Parameter	Symbol	Test Condition	Min	Typ	Max	Units
Input Side Supply Voltage	VDDA		3.0		5.5	V
Input Supply Current	IVDDA	$V_{DDA} = V_{DDB} = 3.3\text{ V}$	3.2	4.2	5.5	mA
Output Side Supply Voltage	VDDB		3.0		5.5	V
Output Supply Current	IVDDB	$V_{DDA} = V_{DDB} = 3.3\text{ V}$	2.7	3.8	4.9	mA
VDD Undervoltage Threshold	VDDUV+	VDDA, VDDB rising		2.7		V
VDD Undervoltage Threshold	VDDUV-	VDDA, VDDB falling		2.6		V
VDD Undervoltage Hysteresis	VDD _{HYS}			100		mV
Amplifier Bandwidth				950		kHz
Amplifier Input						
Specified Full-Scale Input Amplitude	Si8920A	VAIP – VAIN	-100		100	mV
	Si8920B		-200		200	mV
Maximum Input Voltage Before Clipping	Si8920A	VAIP – VAIN		±125		mV
	Si8920B			±250		mV
Common-Mode Operating Range	VCM		-0.2		1	V
Input Referred Offset	VOS			0.2	1.0	mV
Input Offset Drift	VOS _T			1.0		$\mu\text{V}/^\circ\text{C}$
Differential Input impedance	Si8920A	RIN		20		k Ω
	Si8920B			37.2		k Ω
Differential Input Impedance Drift	RIN _T			850		ppm/ $^\circ\text{C}$
Amplifier Output						
Full-scale Output	VAOP – VAON		1.58	1.62	1.65	V _{pk}
Gain	Si8920A			16.2		
	Si8920B			8.1		
Gain Error		$T_A = 25\text{ }^\circ\text{C}$	-0.5		0.5	%
Gain Error Drift				10		ppm/ $^\circ\text{C}$
Output Common Mode Voltage	(VAOP + VAON)/2		1.02	1.1	1.17	V
Output Noise	Si8920A	100 kHz bandwidth		0.14	0.28	mV _{rms}
	Si8920B	100 kHz bandwidth		0.10	0.20	mV _{rms}
Nonlinearity	Si8920A			0.04	0.15	%
	Si8920B			0.025	0.1	%
Output Resistive Load	RLOAD		5			k Ω
Output Capacitive Load	CLOAD				100	pF

Parameter	Symbol	Test Condition	Min	Typ	Max	Units
Timing						
Signal Delay	t_{PD}	50% to 50%		0.75		μs
		50% to 99%		1.85		
Rise Time	t_R	10% to 90%		0.42		μs
Common-Mode Transient Immunity ¹	CMTI	AIP = AIN = AGND, VCM = 1500 V	50	75		kV/ μs

Note:

1. An analog CMTI failure is defined as an output error of more than 100 mV persisting for at least 1 μs .



Figure 4.1. Common-Mode Transient Immunity Characterization Circuit

Table 4.2. IEC Safety Limiting Values¹

Parameter	Symbol	Test Condition	Characteristic	Unit
Safety Temperature	T_S		150	°C
Safety Input Current (DIP-8)	I_S	$\theta_{JA} = 105\text{ °C/W}$ VDD = 5.5 V $T_J = 150\text{ °C}$ $T_A = 25\text{ °C}$	216	mA
		$\theta_{JA} = 105\text{ °C/W}$ VDD = 3.6 V $T_J = 150\text{ °C}$ $T_A = 25\text{ °C}$	331	mA
Safety Input Current (WB SOIC-16)	I_S	$\theta_{JA} = 60\text{ °C/W}$ VDD = 5.5 V $T_J = 150\text{ °C}$ $T_A = 25\text{ °C}$	379	mA
		$\theta_{JA} = 60\text{ °C/W}$ VDD = 3.6 V $T_J = 150\text{ °C}$ $T_A = 25\text{ °C}$	579	mA
Safety Input Power (DIP-8)	P_S	$\theta_{JA} = 105\text{ °C/W}$ $T_J = 150\text{ °C}$ $T_A = 25\text{ °C}$	1191	mW
Safety Input Power (WB SOIC-16)	P_S	$\theta_{JA} = 60\text{ °C/W}$ $T_J = 150\text{ °C}$ $T_A = 25\text{ °C}$	2083	mW
Device Power Dissipation	P_D	PDIP-8	1.19	W
		WB SOIC-16	2.08	W
Note:				
1. Maximum value allowed in the event of a failure. Refer to the thermal derating curves below.				

Table 4.3. Thermal Characteristics

Parameter	Symbol	PDIP-8	WB SOIC-16	Unit
IC Junction-to-Air Thermal Resistance	θ_{JA}	105	60	°C



Figure 4.2. Thermal Derating Curve for Safety Limiting Current (DIP8)



Figure 4.3. Thermal Derating Curve for Safety Limiting Current (WB SOIC-16)

Table 4.4. Absolute Maximum Ratings¹

Parameter	Symbol	Min	Max	Unit
Storage Temperature	T_{STG}	-65	150	°C
Ambient Temperature Under Bias	T_A	-40	125	°C
Junction Temperature	T_J	—	150	°C
Supply Voltage	VDDA, VDDB	-0.5	6.0	V
Input Voltage respect to GNDA	VAIP, VAIN	-0.5	VDDx + 0.5	V
Output Sink or Source Current	I _o	—	5	mA
Total Power Dissipation	P_T	—	212	mW
Lead Solder Temperature (10 s)		—	260	°C
Human Body Model ESD Rating		4000	—	V
Capacitive Discharge Model ESD Rating PDIP		2000	—	V
Capacitive Discharge Model ESD Rating SOIC		2000	—	V
Maximum Isolation (Input to Output) (1 s) PDIP		—	6500	V _{RMS}
Maximum Isolation (Input to Output) (1 s) SOIC		—	6500	V _{RMS}

Note:

1. Permanent device damage may occur if the absolute maximum ratings are exceeded. Functional operation should be restricted to conditions as specified in the operational sections of the data sheet.

4.1 Typical Operating Characteristics



Figure 4.4. Amplifier Bandwidth



Figure 4.5. Gain Error vs. Temperature



Figure 4.6. IDDB vs. Temperature



Figure 4.7. IDDA vs. Temperature



Figure 4.8. Step Response Low to High

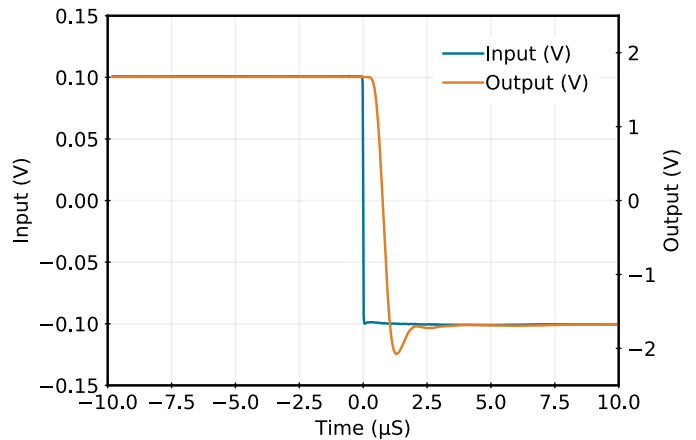

Figure 4.9. Step Response High to Low

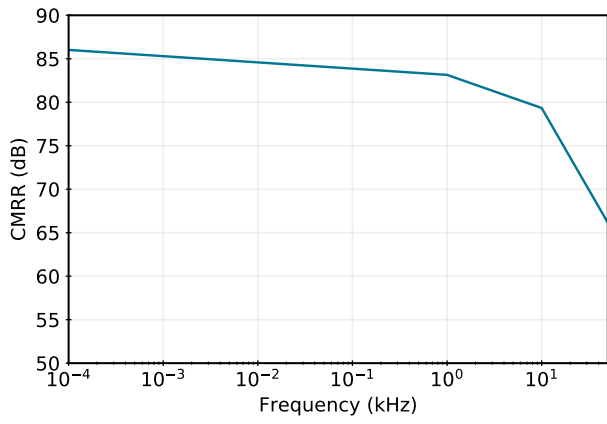

Figure 4.10. CMRR vs. Frequency



Figure 4.11. Normalized Differential Input Resistance vs. Temperature

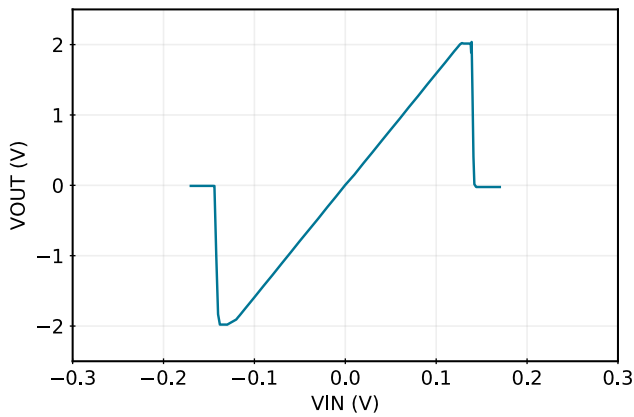

Figure 4.12. Si8920A Typical V_{OUT} vs. V_{IN}



Figure 4.13. Si8920B Typical V_{OUT} vs. V_{IN}

4.2 Regulatory Information

Table 4.5. Regulatory Information^{1, 2}

CSA
The Si8920 is certified under CSA Component Acceptance Notice 5A. For more details, see File 232873.
60950-1: Up to 600 V _{RMS} reinforced insulation working voltage; up to 1000 V _{RMS} basic insulation working voltage.
VDE
The Si8920 is certified according to VDE 0884-10. For more details, see File 5006301-4880-0001.
VDE 0884-10: Up to 1200 V _{peak} for reinforced insulation working voltage.
UL
The Si8920 is certified under UL1577 component recognition program. For more details, see File E257455.
Rated up to 5000 V _{RMS} isolation voltage for basic protection.
CQC
The Si8920 is certified under GB4943.1-2011.
Rated up to 600 V _{RMS} reinforced insulation working voltage; up to 1000 V _{RMS} basic insulation working voltage.
Note:
1. Regulatory Certifications apply to 5 kV _{RMS} rated devices which are production tested to 6.0 kV _{RMS} for 1 sec.
2. Regulatory Certifications apply to 3.75 kV _{RMS} rated devices which are production tested to 4.5 kV _{RMS} for 1 sec.

Table 4.6. Insulation and Safety-Related Specifications

Parameter	Symbol	Test Condition	Value		Unit
			GW DIP-8	WB SOIC-16	
Nominal Air Gap (Clearance)	L(IO1)		7.2	8.0 ¹	mm
Nominal External Tracking (Creepage)	L(IO2)		7.0	8.0 ¹	mm
Minimum Internal Gap (Internal Clearance)			0.016	0.016	mm
Tracking Resistance (Proof Tracking Index)	PTI	IEC60112	600	600	V
Erosion Depth	ED		0.031	0.019	mm
Resistance (Input-Output) ²	R _{IO}		10 ¹²	10 ¹²	Ω
Capacitance (Input-Output) ²	C _{IO}	f = 1 MHz	1	1	pF

Note:

- The values in this table correspond to the nominal creepage and clearance values. VDE certifies the clearance and creepage limits as 8.5 mm minimum for the WB SOIC-16 package. UL does not impose a clearance and creepage minimum for component-level certifications. CSA certifies the clearance and creepage limits as 7.6 mm minimum for the WB SOIC-16 package.
- To determine resistance and capacitance, the Si8920 is converted into a 2-terminal device. Pins 1–8 (1–4 DIP8) are shorted together to form the first terminal, and pins 9–16 (5–8 DIP8) are shorted together to form the second terminal. The parameters are then measured between these two terminals.

Table 4.7. IEC 60664-1 (VDE 0884) Ratings

Parameter	Test Conditions	Specification	
		GW DIP-8	WB SOIC-16
Basic Isolation Group	Material Group	I	I
Installation	Rated Mains Voltages $\leq 150 V_{RMS}$	I-IV	I-IV
Classification	Rated Mains Voltages $\leq 300 V_{RMS}$	I-IV	I-IV
	Rated Mains Voltages $\leq 450 V_{RMS}$	I-III	I-III
	Rated Mains Voltages $\leq 600 V_{RMS}$	I-III	I-III

Table 4.8. VDE 0884-10 Insulation Characteristics¹

Parameter	Symbol	Test Condition	Characteristic		Unit
			3.75 kVrms-rated	5.0 kVrms-rated	
Maximum Working Insulation Voltage	V_{IORM}		891	1200	V peak
Input to Output Test Voltage	V_{PR}	Method b1 ($V_{IORM} \times 1.875 = V_{PR}$, 100% Production Test, $t_m = 1$ sec, Partial Discharge < 5 pC)	1671	2250	V peak
Transient Overvoltage	V_{IOTM}	$t = 60$ sec	6000	8000	V peak
Pollution Degree (DIN VDE 0110, Table 1)			2	2	
Insulation Resistance at T_S , $V_{IO} = 500$ V	R_S		$>10^9$	$>10^9$	Ω

Note:

1. This isolator is suitable for reinforced electrical isolation only within the safety limit data. Maintenance of the safety data is ensured by protective circuits. The Si8920 provides a climate classification of 40/125/21.

5. Pin Descriptions

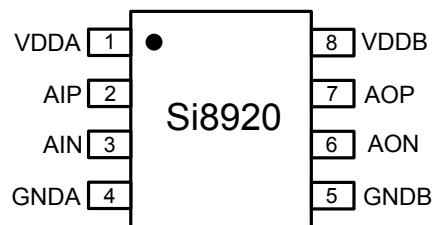

Table 5.1. Si8920 Pin Descriptions

Name	WB SOIC-16 Pin #	GW DIP-8 Pin #	Description
VDDA	1	1	Input side power supply
AIP	2	2	Analog input high
AIN	3	3	Analog input low
GNDA	4, 8	4	Input side ground
GNDB	9, 16	5	Output side ground
AON	11	6	Analog output low
AOP	13	7	Analog output high
VDDB	14	8	Output power supply
NC ¹	5, 6, 7, 10, 12, 15	—	No Connect

Note:

1. No Connect. These pins are not internally connected. To maximize CMTI performance, these pins should be connected to the ground plane.

6. Packaging

6.1 Package Outline: DIP8

The figure below illustrates the package details for the Si8920 in a DIP8 package. The table lists the values for the dimensions shown in the illustration.

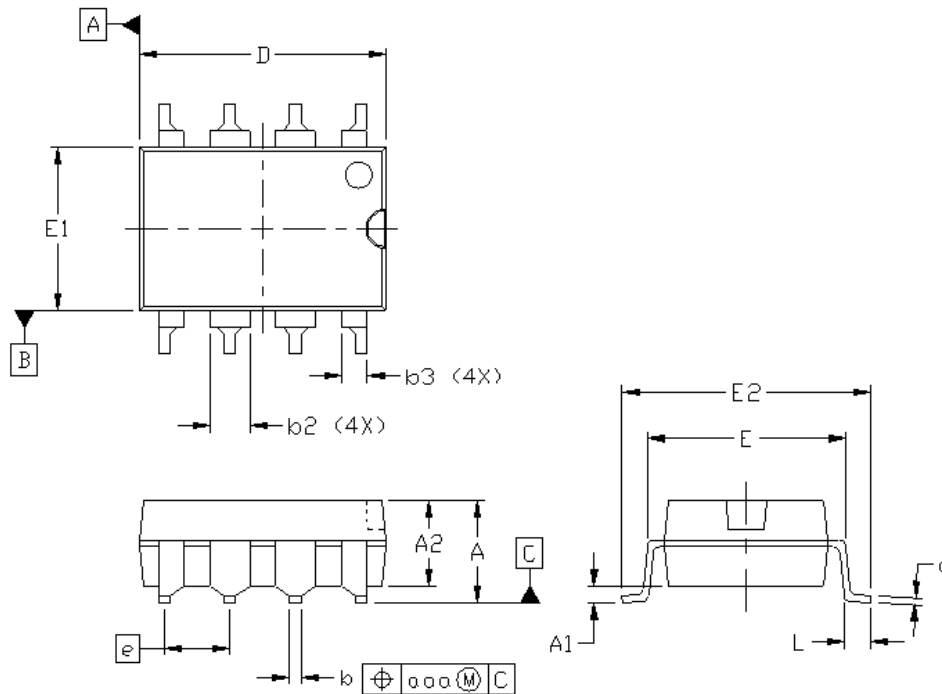

Figure 6.1. DIP8 Package

Table 6.1. DIP8 Package Diagram Dimensions

Dimension	Min	Max
A	—	4.19
A1	0.55	0.75
A2	3.17	3.43
b	0.35	0.55
b2	1.14	1.78
b3	0.76	1.14
c	0.20	0.33
D	9.40	9.90
E	7.37	7.87
E1	6.10	6.60
E2	9.40	9.90
e	2.54 BSC.	
L	0.38	0.89
aaa	—	0.25

Dimension	Min	Max
Note:		
1. All dimensions shown are in millimeters (mm) unless otherwise noted.		
2. Dimensioning and Tolerancing per ANSI Y14.5M-1994.		

6.2 Land Pattern: DIP8

The figure below illustrates the recommended land pattern details for the Si8920 in a DIP8 package. The table lists the values for the dimensions shown in the illustration.

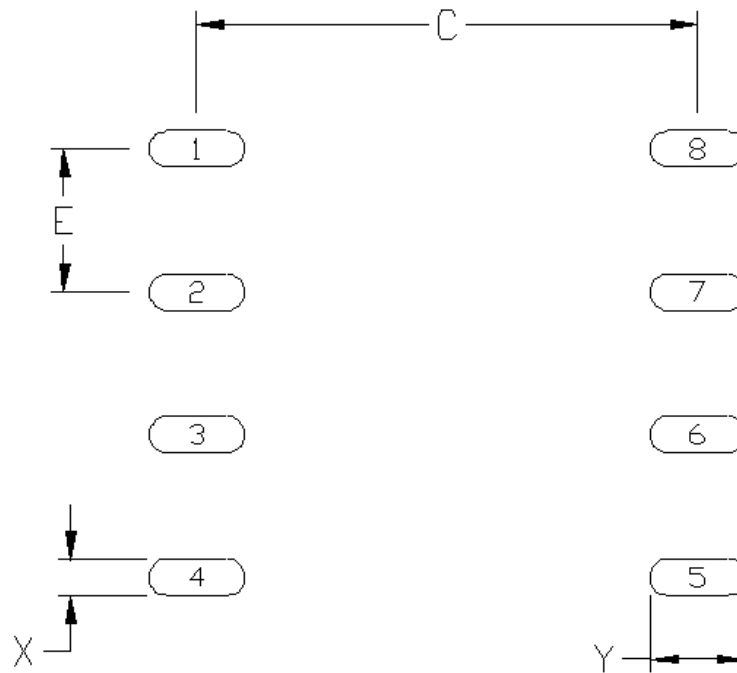

Figure 6.2. DIP8 Land Pattern

Table 6.2. DIP8 Land Pattern Dimensions¹

Dimension	Min	Max
C	8.85	8.90
E	2.54 BSC.	
X	0.60	0.65
Y	1.65	1.70

Note:

1. This Land Pattern Design is based on the IPC-7351 specification.

6.3 Package Outline: 16-Pin Wide Body SOIC

The figure below illustrates the package details for the Si8920 in a 16-Pin Wide Body SOIC package. The table lists the values for the dimensions shown in the illustration.

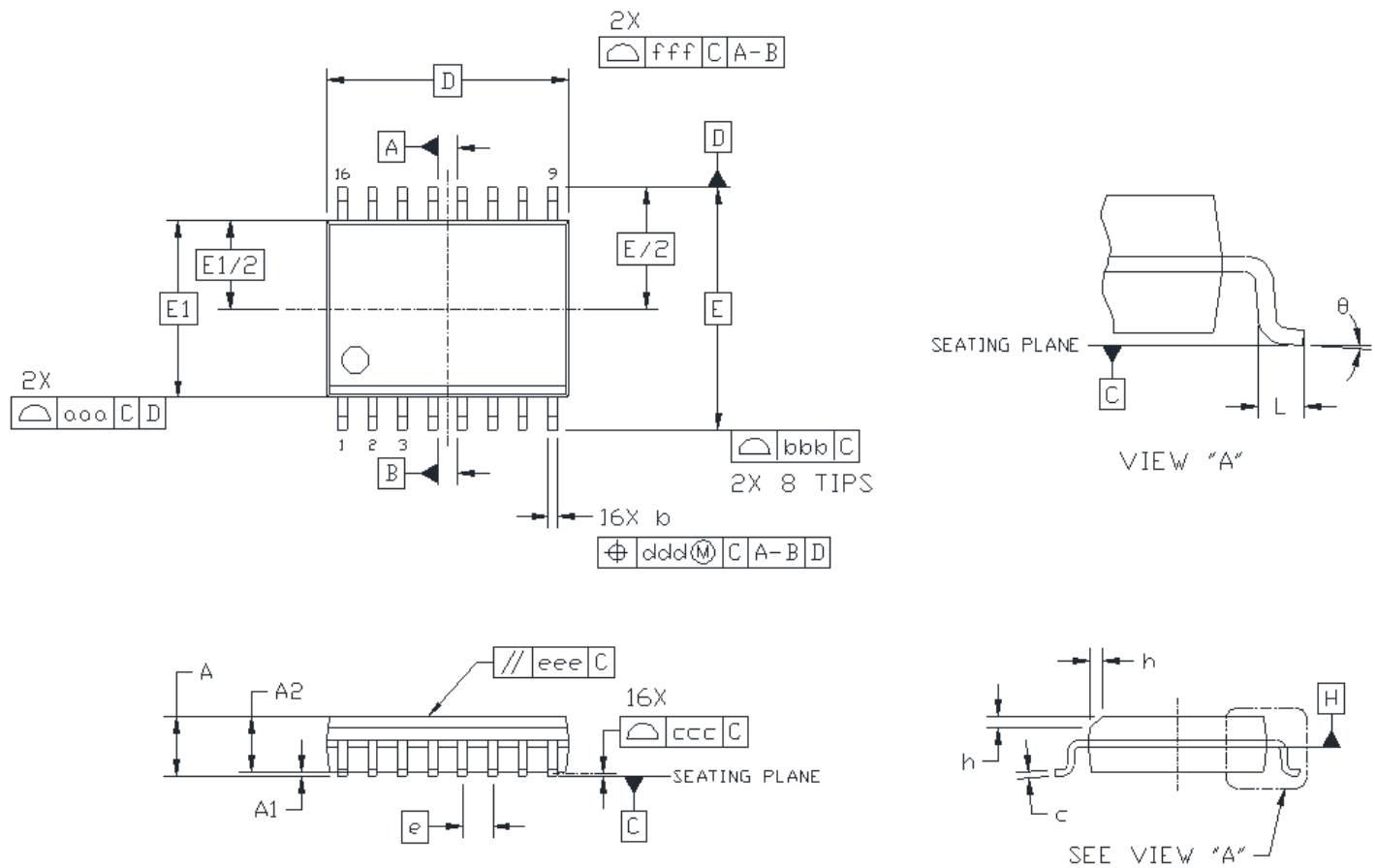

Figure 6.3. 16-Pin Wide Body SOIC Package

Table 6.3. 16-Pin Wide Body SOIC Package Diagram Dimensions

Symbol	Millimeters	
	Min	Max
A	—	2.65
A1	0.10	0.30
A2	2.05	—
b	0.31	0.51
c	0.20	0.33
D	10.30 BSC	
E	10.30 BSC	
E1	7.50 BSC	
e	1.27 BSC	
L	0.40	1.27
h	0.25	0.75
θ	0°	8°

Symbol	Millimeters	
	Min	Max
aaa	—	0.10
bbb	—	0.33
ccc	—	0.10
ddd	—	0.25
eee	—	0.10
fff	—	0.20

Note:

1. All dimensions shown are in millimeters (mm) unless otherwise noted.
2. Dimensioning and Tolerancing per ANSI Y14.5M-1994.
3. This drawing conforms to JEDEC Outline MS-013, Variation AA.
4. Recommended reflow profile per JEDEC J-STD-020C specification for small body, lead-free components.

6.4 Land Pattern: 16-Pin Wide Body SOIC

The figure below illustrates the recommended land pattern details for the Si8920 in a 16-Pin Wide Body SOIC package. The table lists the values for the dimensions shown in the illustration.



Figure 6.4. 16-Pin Wide Body SOIC Land Pattern

Table 6.4. 16-Pin Wide Body SOIC Land Pattern Dimensions¹

Dimension	Feature	(mm)
C1	Pad Column Spacing	9.40
E	Pad Row Pitch	1.27
X1	Pad Width	0.60
Y1	Pad Length	1.90

Note:

1. This Land Pattern Design is based on IPC-7351 pattern SOIC127P1032X265-16AN for Density Level B (Median Land Protrusion).
2. All feature sizes shown are at Maximum Material Condition (MMC) and a card fabrication tolerance of 0.05 mm is assumed.

6.5 Top Marking: DIP8

The figure below illustrates the top markings for the Si8920 in a DIP8 package. The table explains the top marks shown in the illustration.



Figure 6.5. Si8920 DIP8 Top Marking

Table 6.5. DIP8 Top Marking Explanation

Line 1 Marking:	Customer Part Number	Si8920 = Isolator Amplifier Series S = Input Range: <ul style="list-style-type: none"> • A = ± 100 mV • B = ± 200 mV V = Insulation rating: <ul style="list-style-type: none"> • C = 3.75 kV • D = 5.0 kV
Line 2 Marking:	YY = Year WW = Work Week	Assigned by the Assembly House. Corresponds to the year and work week of the mold date.
	RTTTTT = Mfg Code	Manufacturing Code from the Assembly Purchase Order form. “R” indicates revision.
Line 3 Marking:	Circle = 51 mils Diameter Center-Justified	“e4” Pb-Free Symbol
	Country of Origin (Iso-Code Abbreviation)	CC

6.6 Top Marking: 16-Pin Wide Body SOIC

The figure below illustrates the top markings for the Si8920 in a 16-Pin Wide Body SOIC package. The table explains the top marks shown in the illustration.



Figure 6.6. Si8920 16-Pin Wide Body SOIC Top Marking

Table 6.6. 16-Pin Wide Body SOIC Top Mark Explanation

Line 1 Marking:	Customer Part Number	Si8920 = Isolator Amplifier Series S = Input Range: <ul style="list-style-type: none"> • A = ± 100 mV • B = ± 200 mV V = Insulation rating: <ul style="list-style-type: none"> • C = 3.75 kV • D = 5.0 kV
Line 2 Marking:	YY = Year WW = Work Week	Assigned by the Assembly House. Corresponds to the year and work week of the mold date.
	RTTTTT = Mfg Code	Manufacturing Code from the Assembly Purchase Order form. "R" indicates revision.
Line 3 Marking:	Circle = 43 mils Diameter Left-Justified	"e4" Pb-Free Symbol

7. Revision History

Revision 1.03

January 2019

- Added new OPNs for 3.75kVrms in WB SOIC-16 package

Revision 1.02

May 2018

- Updated the Ordering Guide for Automotive-Grade OPN option

Revision 1.01

April 2018

- Added an Ordering Guide for Automotive-Grade OPN option

Revision 1.0

- Updated linearity, offset, gain drift, and IVVDB specifications.
- Added typical Vout vs. Vin charts.
- Added [Table 4.2 IEC Safety Limiting Values¹](#) on page 8, [Table 4.3 Thermal Characteristics](#) on page 8, and thermal derating curves.

Revision 0.8

- Corrected the C6 equation in [3. Current Sense Application](#).

Revision 0.7

- Updated [Figure 6.1 DIP8 Package](#) on page 16.



Smart.
Connected.
Energy-Friendly



Products
www.silabs.com/products



Quality
www.silabs.com/quality



Support and Community
community.silabs.com

Disclaimer

Silicon Labs intends to provide customers with the latest, accurate, and in-depth documentation of all peripherals and modules available for system and software implementers using or intending to use the Silicon Labs products. Characterization data, available modules and peripherals, memory sizes and memory addresses refer to each specific device, and "Typical" parameters provided can and do vary in different applications. Application examples described herein are for illustrative purposes only. Silicon Labs reserves the right to make changes without further notice to the product information, specifications, and descriptions herein, and does not give warranties as to the accuracy or completeness of the included information. Without prior notification, Silicon Labs may update product firmware during the manufacturing process for security or reliability reasons. Such changes will not alter the specifications or the performance of the product. Silicon Labs shall have no liability for the consequences of use of the information supplied in this document. This document does not imply or expressly grant any license to design or fabricate any integrated circuits. The products are not designed or authorized to be used within any FDA Class III devices, applications for which FDA premarket approval is required or Life Support Systems without the specific written consent of Silicon Labs. A "Life Support System" is any product or system intended to support or sustain life and/or health, which, if it fails, can be reasonably expected to result in significant personal injury or death. Silicon Labs products are not designed or authorized for military applications. Silicon Labs products shall under no circumstances be used in weapons of mass destruction including (but not limited to) nuclear, biological or chemical weapons, or missiles capable of delivering such weapons. Silicon Labs disclaims all express and implied warranties and shall not be responsible or liable for any injuries or damages related to use of a Silicon Labs product in such unauthorized applications.

Trademark Information

Silicon Laboratories Inc.®, Silicon Laboratories®, Silicon Labs®, SiLabs® and the Silicon Labs logo®, Bluegiga®, Bluegiga Logo®, Clockbuilder®, CMEMS®, DSPLL®, EFM®, EFM32®, EFR, Ember®, Energy Micro, Energy Micro logo and combinations thereof, "the world's most energy friendly microcontrollers", Ember®, EZLink®, EZRadio®, EZRadioPRO®, Gecko®, ISOModem®, Precision32®, ProSLIC®, Simplicity Studio®, SiPHY®, Telegesis, the Telegesis Logo®, USBXpress® and others are trademarks or registered trademarks of Silicon Labs. ARM, CORTEX, Cortex-M3 and THUMB are trademarks or registered trademarks of ARM Holdings. Keil is a registered trademark of ARM Limited. All other products or brand names mentioned herein are trademarks of their respective holders.



Silicon Laboratories Inc.
400 West Cesar Chavez
Austin, TX 78701
USA

<http://www.silabs.com>



**Стандарт
Электрон
Связь**

Мы молодая и активно развивающаяся компания в области поставок электронных компонентов. Мы поставляем электронные компоненты отечественного и импортного производства напрямую от производителей и с крупнейших складов мира.

Благодаря сотрудничеству с мировыми поставщиками мы осуществляем комплексные и плановые поставки широчайшего спектра электронных компонентов.

Собственная эффективная логистика и склад в обеспечивает надежную поставку продукции в точно указанные сроки по всей России.

Мы осуществляем техническую поддержку нашим клиентам и предпродажную проверку качества продукции. На все поставляемые продукты мы предоставляем гарантию .

Осуществляем поставки продукции под контролем ВП МО РФ на предприятия военно-промышленного комплекса России , а также работаем в рамках 275 ФЗ с открытием отдельных счетов в уполномоченном банке. Система менеджмента качества компании соответствует требованиям ГОСТ ISO 9001.

Минимальные сроки поставки, гибкие цены, неограниченный ассортимент и индивидуальный подход к клиентам являются основой для выстраивания долгосрочного и эффективного сотрудничества с предприятиями радиоэлектронной промышленности, предприятиями ВПК и научно-исследовательскими институтами России.

С нами вы становитесь еще успешнее!

Наши контакты:

Телефон: +7 812 627 14 35

Электронная почта: sales@st-electron.ru

Адрес: 198099, Санкт-Петербург,
Промышленная ул, дом № 19, литера Н,
помещение 100-Н Офис 331