

# Telpower® High Current Switch

# TPHCS

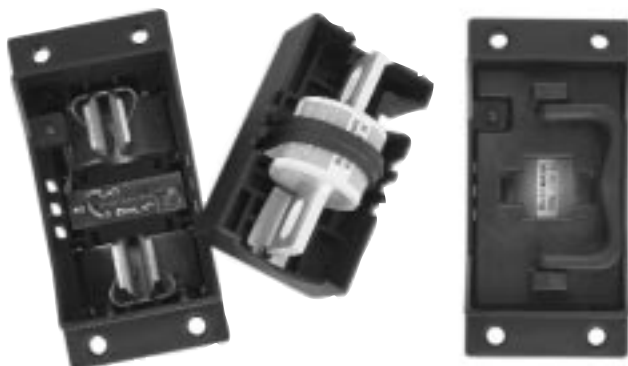

TPHCS800-MAV (shown)

## TPHCS

### Telpower® High Current Switch

For use with Telpower® Fuses Type TPL-B AND TPL-C.

Patents Pending

Ampere Ratings: 70 to 800 Amperes

Voltage Rating: 80 Volts DC

U.L. Withstand Rating: 100,000A

Agency Information:

U.L. Recognized (investigated to U.L. 1801) as a disconnect switch for the interruption of load current by means of withdrawing the fuse carrier.

U.L. Recognized to meet the requirements for Canadian Standards.

General Information:

- Innovative new design eliminates need for tools to replace the Telpower® type TPL-B or TPL-C fuse.
- Easy to install—captive fasteners allow for direct busbar mounting (bolts not included).
- Optional new electronic alarm provides both local and remote open-fuse indications.
  - Bipolar alarm designed for both Central Office and Radio applications.
  - Local LED alarm indication for ease-of-viewing.
  - Standard ¼" male quick-connect terminal for effortless remote alarm connection (Maximum remote alarm current: 20mA).
  - Eliminates need for parallel indicating fuses.
- Fuse presence window allows for easy viewing of installed fuse ampere rating.
- Compact design for today's high power, high-density cabinets.
- Available as complete switch or pullout and base may be purchased separately.

### Part Number System—Switches (Pullout and Base)

To identify part number, replace block with appropriate suffix to identify amperage, thread type, and alarm option.



Amperage (select one)

250 - For Use With 70 to 250 Amp Type TPL-B Fuses

800 - For Use With 300 to 800 Amp Type TPL-C Fuses

Thread (select one)

M - Metric, M8 x 1.25

E - English, 5/16 - 18

Alarm (leave blank for non-alarming version)

L - LED Only, Requires Input From Customer Alarm Circuit

\*AV - Alarm, System Voltage

\*Consult factory for availability

### Part Number System—Bases

To identify part number, replace block with appropriate suffix to identify thread type, and alarm option.

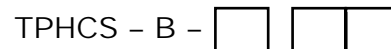

Thread (select one)

M - Metric, M8 x 1.25

E - English, 5/16 - 18

Alarm (leave blank for non-alarming version)

L - LED Only, Requires Input From Customer Alarm Circuit

\*AV - Alarm, System Voltage

\*Consult factory for availability

Catalog Numbers-Switches (Pullout and Base)	Series Fuse	Ampere Rating
TPHCS250-M High Current Switch, Metric	TPL-B	70 to 250 Amp
TPHCS250-E High Current Switch, English	TPL-B	70 to 250 Amp
TPHCS250-ML High Current Switch, Metric, LED	TPL-B	70 to 250 Amp
TPHCS250-EL High Current Switch, English, LED	TPL-B	70 to 250 Amp
TPHCS250-MAV High Current Switch, Metric, Alarm	TPL-B	70 to 250 Amp
TPHCS250-EAV High Current Switch, English, Alarm	TPL-B	70 to 250 Amp
TPHCS800-M High Current Switch, Metric	TPL-C	300 to 800 Amp
TPHCS800-E High Current Switch, English	TPL-C	300 to 800 Amp
TPHCS800-ML High Current Switch, Metric, LED	TPL-C	300 to 800 Amp
TPHCS800-EL High Current Switch, English, LED	TPL-C	300 to 800 Amp
TPHCS800-MAV High Current Switch, Metric, Alarm	TPL-C	300 to 800 Amp
TPHCS800-EAV High Current Switch, English, Alarm	TPL-C	300 to 800 Amp

Catalog Numbers - Components	Series Fuse	Ampere Rating
TPHCS250-P Pullout only - 250 A	TPL-B	70 to 250 Amp
TPHCS800-P Pullout only - 800 A	TPL-C	300 to 800 Amp
TPHCS-B-M Base only, Metric	—	800 Amp Max.
TPHCS-B-E Base only, English	—	800 Amp Max.
TPHCS-B-ML Base only, Metric, LED	—	800 Amp Max.
TPHCS-B-EL Base only, English, LED	—	800 Amp Max.
TPHCS-B-MAV Base only, Metric, Alarm	—	800 Amp Max.
TPHCS-B-EAV Base only, English, Alarm	—	800 Amp Max.

# Telpower® High Current Switch

# TPHCS

## TPHCS □ -M & -E

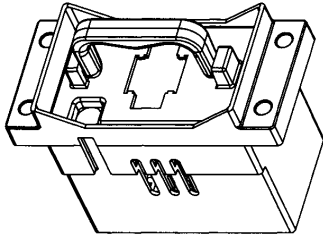

**NOTE:**  
1. TPHCS -M and -E are the same with the exception of thread type.

## TPHCS □ -ML & -EL

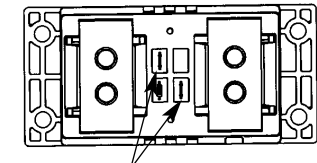
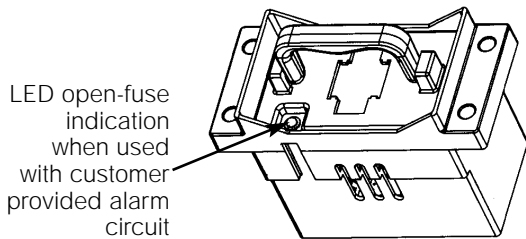

BOTTOM VIEW

LED alarm connections 1/4" male quick connects.

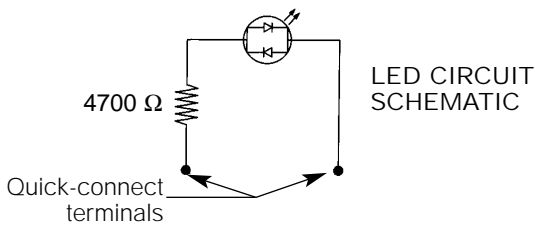

**NOTES:** 1. TPHCS -ML & -EL are the same with the exception of thread type.  
2. Maximum continuous LED current 20mA.

## TPHCS-Dimensional Data

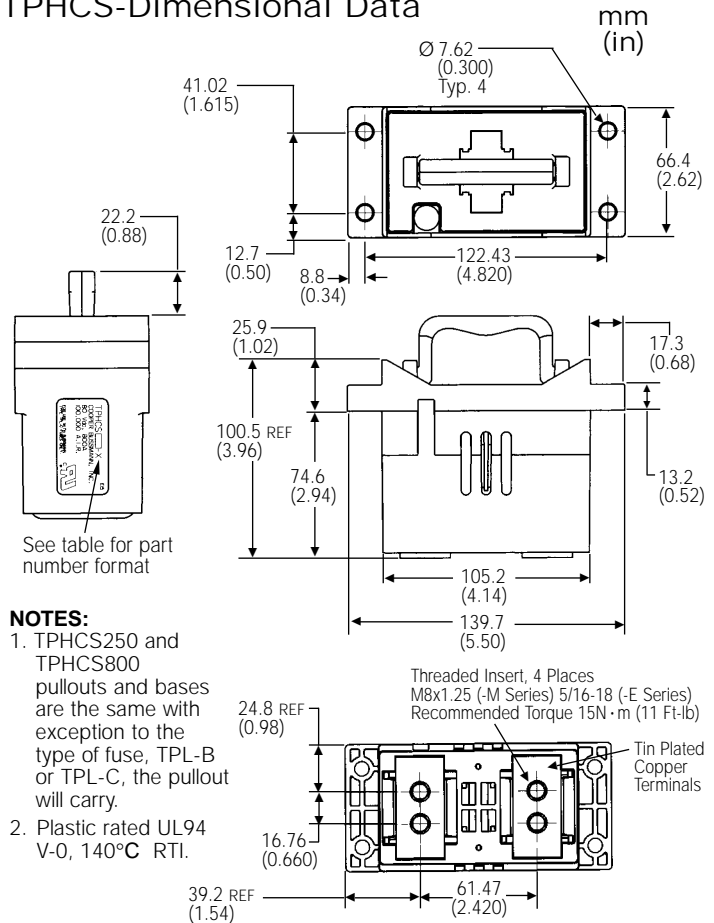

**NOTES:**

1. TPHCS250 and TPHCS800 pullouts and bases are the same with exception to the type of fuse, TPL-B or TPL-C, the pullout will carry.
2. Plastic rated UL94 V-0, 140°C RTI.

## TPHCS COMPONENTS

See Catalog Numbers for complete list

### PULLOUTS

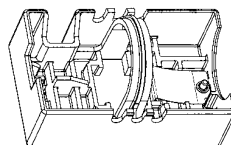

TPHCS800-P

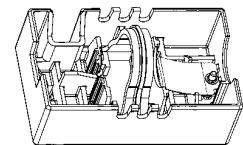

TPHCS250-P

### BASES

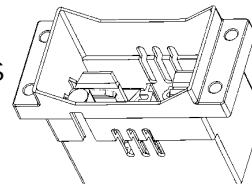

TPHCS-B-M (shown for reference)

The only controlled copy of this BIF document is the electronic read-only version located on the Bussmann Network Drive. All other copies of this BIF document are by definition uncontrolled. This bulletin is intended to clearly present comprehensive product data and provide technical information that will help the end user with design applications. Bussmann reserves the right, without notice, to change design or construction of any products and to discontinue or limit distribution of any products. Bussmann also reserves the right to change or update, without notice, any technical information contained in this bulletin. Once a product has been selected, it should be tested by the user in all possible applications.



**Стандарт  
Электрон  
Связь**

Мы молодая и активно развивающаяся компания в области поставок электронных компонентов. Мы поставляем электронные компоненты отечественного и импортного производства напрямую от производителей и с крупнейших складов мира.

Благодаря сотрудничеству с мировыми поставщиками мы осуществляем комплексные и плановые поставки широчайшего спектра электронных компонентов.

Собственная эффективная логистика и склад в обеспечивает надежную поставку продукции в точно указанные сроки по всей России.

Мы осуществляем техническую поддержку нашим клиентам и предпродажную проверку качества продукции. На все поставляемые продукты мы предоставляем гарантию .

Осуществляем поставки продукции под контролем ВП МО РФ на предприятия военно-промышленного комплекса России , а также работаем в рамках 275 ФЗ с открытием отдельных счетов в уполномоченном банке. Система менеджмента качества компании соответствует требованиям ГОСТ ISO 9001.

Минимальные сроки поставки, гибкие цены, неограниченный ассортимент и индивидуальный подход к клиентам являются основой для выстраивания долгосрочного и эффективного сотрудничества с предприятиями радиоэлектронной промышленности, предприятиями ВПК и научно-исследовательскими институтами России.

С нами вы становитесь еще успешнее!

**Наши контакты:**

**Телефон:** +7 812 627 14 35

**Электронная почта:** [sales@st-electron.ru](mailto:sales@st-electron.ru)

**Адрес:** 198099, Санкт-Петербург,  
Промышленная ул, дом № 19, литера Н,  
помещение 100-Н Офис 331