

PLEASE CHECK WWW.MOLEX.COM FOR LATEST PART INFORMATION

Part Number: [0740601001](#)
Status: **Active**
Overview: [vhdm](#)
Description: 2.00mm (.079") Pitch VHDM® Board-to-Board Backplane Header, Vertical, 8-Row, Open Signal Module, 80 Circuits, Pin Length 4.75mm (.187")

Documents:

[3D Model](#) [Product Specification PS-74031-999 \(PDF\)](#)
[Drawing \(PDF\)](#) [RoHS Certificate of Compliance \(PDF\)](#)

Agency Certification

UL E29179

General

Product Family Backplane Connectors
 Series [74060](#)
 Application Backplane
 Application Tooling Documents [Tooling Manual](http://www.molex.com/pdm_docs/ats/TM-622010999.pdf)
 Comments Open Header
 Component Type PCB Header
 Overview [vhdm](#)
 Product Name VHDM®
 Style N/A

Physical

Circuits (Loaded) 80
 Circuits (maximum) 80
 Color - Resin Black
 Durability (mating cycles max) 200
 First Mate / Last Break No
 Flammability 94V-0
 Guide to Mating Part No
 Keying to Mating Part None
 Material - Metal Beryllium Copper, High Performance Alloy (HPA)
 Material - Plating Mating Gold
 Material - Plating Termination Tin-Lead
 Material - Resin High Temperature Thermoplastic
 Number of Columns N/A
 Number of Pairs Open Pin Field
 Number of Rows 8
 Orientation Vertical
 PC Tail Length (in) 0.098 In
 PC Tail Length (mm) 2.50 mm
 PCB Locator No
 PCB Retention None
 PCB Thickness Recommended (in) 0.070 In
 PCB Thickness Recommended (mm) 1.80 mm
 Packaging Type Tube
 Pitch - Mating Interface (in) 0.079 In
 Pitch - Mating Interface (mm) 2.00 mm
 Pitch - Term. Interface (in) 0.039 In
 Pitch - Term. Interface (mm) 1.00 mm
 Plating min: Mating (µin) 30
 Plating min: Mating (µm) 0.75
 Plating min: Termination (µin) 30

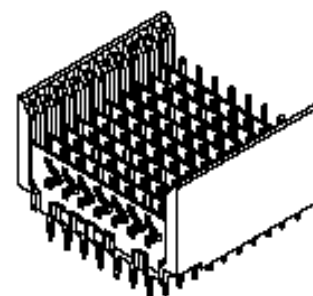

image - Reference only

Series

EU RoHS

RoHS Compliant by Exemption

REACH SVHC

Contains SVHC: No

Halogen-Free

Status

Halogen-Free

China RoHS



Pb

Need more information on product environmental compliance?

Email productcompliance@molex.com
 For a multiple part number RoHS Certificate of Compliance, [click here](#)

Please visit the [Contact Us](#) section for any non-product compliance questions.

Search Parts in this Series

[74060Series](#)

Mates With

[74040 VHDM® Board-to-Board Daughtercard Receptacle](#)

Application Tooling | FAQ

Tooling specifications and manuals are found by selecting the products below. Crimp Height Specifications are then contained in the Application Tooling Specification document.

Global

Description	Product #
Flat Rock Tooling for Pneumatic Press	0622013700
VHDM® Signal Pin	0622015700
Insert Repair Tool	
VHDM® 8 Row Pin and Shield Repair Tool	0622015900

Plating min: Termination (µm)	0.75
Polarized to PCB	Yes
Stackable	Yes
Surface Mount Compatible (SMC)	Yes
Temperature Range - Operating	-55°C to +105°C
Termination Interface: Style	Through Hole - Compliant Pin

Electrical

Current - Maximum per Contact	3A
Data Rate	3.125 Gbps
Real Signals (per 25mm)	100
Shield Type	Ground Plane Shield
Shielded	Yes
Voltage - Maximum	120V AC (RMS)/DC

Material Info

Reference - Drawing Numbers

Packaging Specification	PK-74060-003
Product Specification	PS-74031-999
Sales Drawing	SD-74060-002

VHDM and Very High Density Metric are trademarks of Amphenol Corporation

VHDM® 8 Row Shield Extraction Tool	0622016100
VHDM® Insertion Module for Advanced Mate Signal Header, 8 Row by 10 Wide, 20.00mm (.787")	0622020205
VHDM® Insertion Module for Standard Shield Signal Header, 8 Row by 10 Wide, 20.00mm (.787")	0622020209

This document was generated on 05/19/2010

PLEASE CHECK WWW.MOLEX.COM FOR LATEST PART INFORMATION

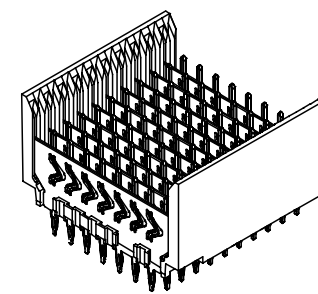
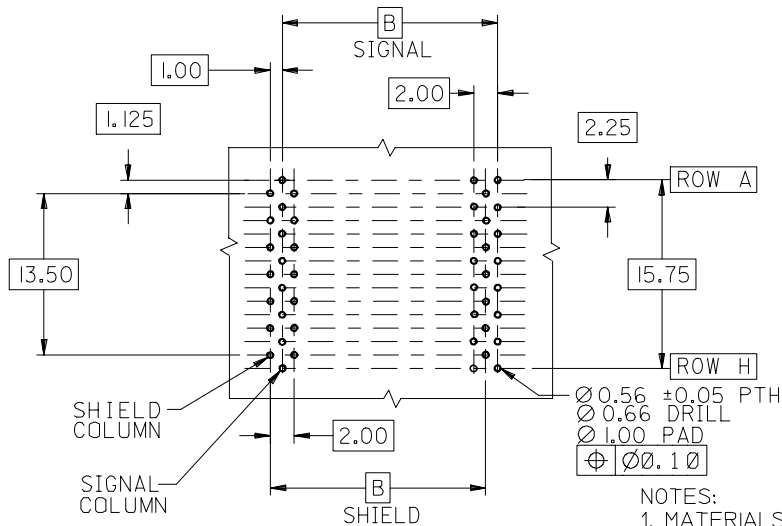
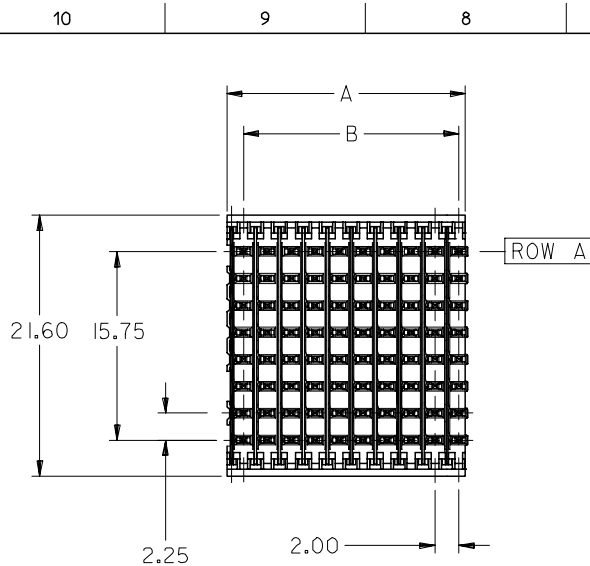

**BACKPLANE HOLE PATTERN
RECOMMENDED DIMENSION**

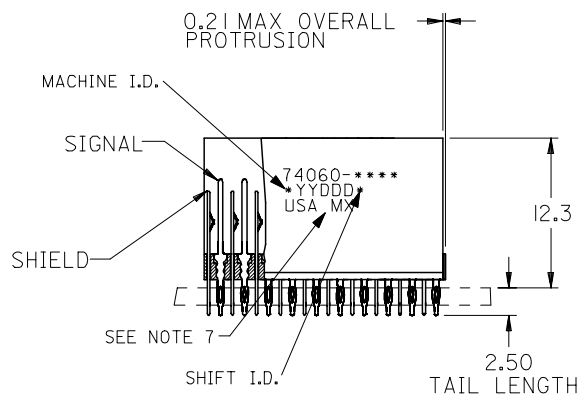
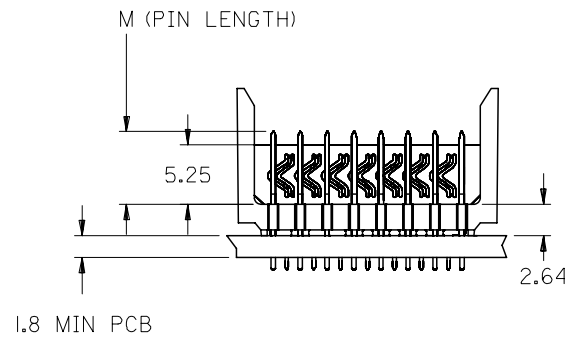

- NOTES:
- MATERIALS:
HOUSING - LIQUID CRYSTAL POLYMER (LCP),
GLASS-FILLED, UL 94V-0, COLOR: BLACK
SIGNAL PIN & SHIELD - COPPER ALLOY
 - FINISHES:
CONTACT AREA: SELECTIVE GOLD (Au)
PCB TAILS: SELECTIVE TIN/LEAD (Sn/Pb)
OR SELECTIVE MATTE TIN (Sn)
NICKEL (Ni) OVERALL.
 - THIS PART CONFORMS TO MOLEX PRODUCT SPECIFICATION PS-74031-999
 - FOR MIXED CONTACT LENGTHS CONSULT MOLEX FOR AVAILABILITY
 - FOR SPECIFIC MATERIAL NUMBERS & MATING INFORMATION REFER TO SHEET 2
 - PACKAGE PER PK-74060-003
 - EITHER MARK PART WITH PART NUMBER & DATE CODE APPROXIMATELY WHERE SHOWN OR PLACE LABEL ON THE TUBE.

ADD LEADFREE PNs EC NO: UCP2006-0079 DRW:KMK/MLVEY 2005/07/20 CHKD: 2005/07/21 APPR: SREED 2005/07/22	QUALITY SYMBOLS ▽=0 ▽=0	GENERAL TOLERANCES (UNLESS SPECIFIED)		DIMENSION STYLE	SCALE	DESIGN UNITS	THIRD ANGLE PROJECTION	
				MM ONLY	2.5:1	METRIC		
				DRAWN BY	DATE	TITLE		
				DATE	DATE	VHDM 8 ROW OPEN END BACKPLANE SALES ASSEMBLY		
		4 PLACES	± ---	± ---	MWANG	1998/11/09	MOLEX INCORPORATED	
		3 PLACES	± ---	± ---	CHECKED BY	DATE		
		2 PLACES	± ---	± ---	JLAURX	1998/11/09		
		1 PLACE	± ---	± ---	APPROVED BY	DATE		
		ANGULAR ±1/2°		CBIXLER	1998/11/09			
		DRAFT WHERE APPLICABLE MUST REMAIN WITHIN DIMENSIONS		MATERIAL NO.	DOCUMENT NO.		SHEET NO.	
				SEE SHEET 2	SD-74060-002		1 OF 2	
		THIS DRAWING CONTAINS INFORMATION THAT IS PROPRIETARY TO MOLEX INCORPORATED AND SHOULD NOT BE USED WITHOUT WRITTEN PERMISSION						

10 9 8 7 6 5 4 3 2 1

F
E
D
C
B
A

SIGNAL COLUMN
DAUGHTERCARD CONNECTOR SIDE

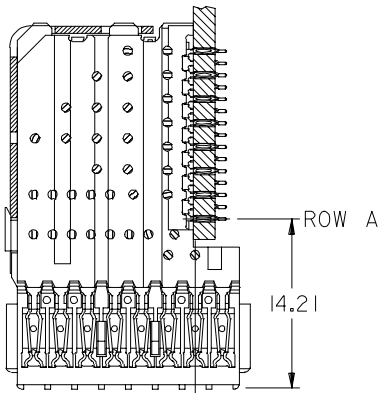
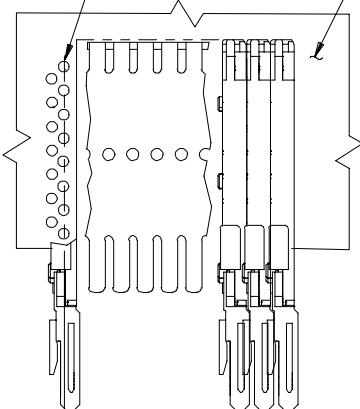

PART NUMBER	COLUMN	NUMBER OF SIGNAL PIN	NUMBER OF SHIELD	A	B	M	Au (um) THICKNESS	Sn (um) THICKNESS
74060-*001	10	80	10	20.00	18.00	4.75	0.76	0.76-1.52
74060-*006							1.27	
74060-*501	25	200	25	50.00	48.00	6.25	0.76	
74060-*506							1.27	
74060-*002	10	80	10	20.00	18.00	4.25	0.76	
74060-*007							1.27	
74060-*502	25	200	25	50.00	48.00	5.15	0.76	
74060-*507							1.27	
74060-*003	10	80	10	20.00	18.00	4.25	0.76	
74060-*008							1.27	
74060-*503	25	200	25	50.00	48.00	5.15	0.76	
74060-*508							1.27	
74060-*004	10	80	10	20.00	18.00	4.25	0.76	
74060-*009							1.27	
74060-*504	25	200	25	50.00	48.00	5.15	0.76	
74060-*509							1.27	

ROW A
14.21

0.41 OFFSET SIGNAL TO SIGNAL

2.45
TOP OF DAUGHTERCARD PCB TO ϕ OF ROW A

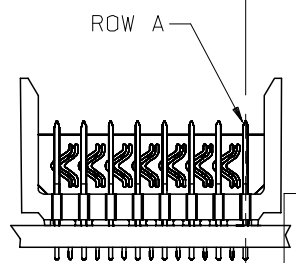
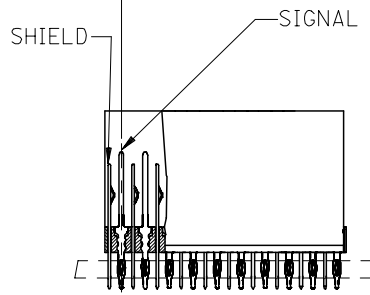

MATERIAL NUMBER ASSIGNMENT

74060-** **
SEE TABLE
NUMBER OF COLUMNS/PLATING
10 = 10 COLUMN TIN/LEAD
25 = 25 COLUMN TIN/LEAD
90 = 10 COLUMN MATTE TIN
85 = 25 COLUMN MATTE TIN

SEE SHEET 1
EC NO: UCP2006-0079
DRWNG: MULLVEY 2005/07/20
CHKD: 2005/07/21
APPR: SREED 2005/07/22

QUALITY SYMBOLS
=0
=0

GENERAL TOLERANCES (UNLESS SPECIFIED)

	mm	INCH
4 PLACES	± ---	± ---
3 PLACES	± ---	± ---
2 PLACES	± ---	± ---
1 PLACE	± ---	± ---

ANGULAR ±1/2°

DRAFT WHERE APPLICABLE MUST REMAIN WITHIN DIMENSIONS

DIMENSION STYLE
MM ONLY

DRAWN BY DATE
MWANG 1998/11/09

CHECKED BY DATE
JLAURX 1998/11/09

APPROVED BY DATE
CBIXLER 1998/11/09

MATERIAL NO.
SEE CHART

SCALE
2.5:1

DESIGN UNITS
METRIC

THIRD ANGLE PROJECTION

TITLE
VHDM 8 ROW
OPEN END BACKPLANE
SALES ASSEMBLY

MOLEX INCORPORATED

DOCUMENT NO.
SD-74060-002

SHEET NO.
2 OF 2

9 8 7 6 5 4 3 2 1



Стандарт Электрон Связь

Мы молодая и активно развивающаяся компания в области поставок электронных компонентов. Мы поставляем электронные компоненты отечественного и импортного производства напрямую от производителей и с крупнейших складов мира.

Благодаря сотрудничеству с мировыми поставщиками мы осуществляем комплексные и плановые поставки широчайшего спектра электронных компонентов.

Собственная эффективная логистика и склад в обеспечивает надежную поставку продукции в точно указанные сроки по всей России.

Мы осуществляем техническую поддержку нашим клиентам и предпродажную проверку качества продукции. На все поставляемые продукты мы предоставляем гарантию .

Осуществляем поставки продукции под контролем ВП МО РФ на предприятия военно-промышленного комплекса России , а также работаем в рамках 275 ФЗ с открытием отдельных счетов в уполномоченном банке. Система менеджмента качества компании соответствует требованиям ГОСТ ISO 9001.

Минимальные сроки поставки, гибкие цены, неограниченный ассортимент и индивидуальный подход к клиентам являются основой для выстраивания долгосрочного и эффективного сотрудничества с предприятиями радиоэлектронной промышленности, предприятиями ВПК и научно-исследовательскими институтами России.

С нами вы становитесь еще успешнее!

Наши контакты:

Телефон: +7 812 627 14 35

Электронная почта: sales@st-electron.ru

Адрес: 198099, Санкт-Петербург,
Промышленная ул, дом № 19, литера Н,
помещение 100-Н Офис 331