

# Gladius G1050 Series

## 10.4" Intel® Atom™ Z530P Rugged Tablet PC



### Features

- 10.4" AFFS+ TFT Active Matrix with Resistive Touch Panel
- Ultra Low Power Consumption
- Fully Rugged for Mobile POS or Warehousing Application
- Meet MIL-STD-810F, IP54, 4 ft. Drop Resistance
- High Mobility, Multiple Connectivity (Bluetooth/WLAN/3.75G)
- Identification Devices (Barcode Scanner, RFID Reader and MSR)
- Hot-swappable external battery w/ redundant internal battery
- 23-key Keypad with Numeric Keys and Function Keys
- I.P.A. (Isopropyl) Alcohol Clearing Allowed

### System

<b>CPU</b>	Intel® Atom™ Z530P 1.6GHz processor
<b>Graphics Controller</b>	Intel® GMA 500
<b>Memory</b>	2GB DDR2 SO-DIMM memory module installed
<b>Chipset</b>	Intel® System Controller Hub US15WPT
<b>BIOS</b>	AMI BIOS
	1 x Integrated microphone
<b>Audio</b>	1 x Integrated 2W speaker
	1 x Earphone jack
<b>Storage</b>	1 x 32GB 1.8" SSD

### Peripherals and Devices

<b>Camera</b>	1 x 2.0 megapixels Auto Focus CMOS camera
<b>RFID</b>	Integrated 13.56MHz, ISO 15693/14443A/14443B RFID Reader (distance: 3~5cm; speed: 5 cards/sec) (optional)
<b>Wi-Fi</b>	Integrated WLAN 802.11 b/g/n
<b>Bluetooth</b>	Integrated Bluetooth 2.1 + EDR
<b>GSM/UMTS</b>	Optional HSUPA module (3.75G) for GSM/GPRS/EDGE, EV-DO networks
<b>Barcode Scanner</b>	1 x 1D/2D Barcode scanner (optional)
<b>MSR</b>	Integrated Magnetic Stripe Reader (optional)

### I/O Interface

<b>USB Port</b>	1 x USB 2.0 port
<b>SD Card</b>	1 x SD/SDHC slot
<b>Docking Port</b>	1 x 35-pin pogo connector for docking connection
<b>Expansion</b>	1 x ExpressCard/34 or USB 2.0

### Button & Indicator

<b>Function Key</b>	10 x Numeric keys (0 ~ 9); 1 x Enter key; 1 x 4-way arrow keys; 4 x Function keys; 1 x ESC key; 1 x Backspace key; 1 x Dot (.) key; 1 x Brightness control key;
<b>Power Button</b>	1 x Power on/off button
	1 x Battery LED
<b>LED Indicator</b>	1 x RFID (optional)/HSUPA (optional) LED
	1 x Bluetooth (optional) LED

### LCD Display

<b>Size/Type</b>	10.4" AFFS+ TFT Active Matrix Panel
<b>Max. Resolution</b>	1024 x 768 (XGA) w/ 262,144 colors
	340 cd/m <sup>2</sup> (typ.)
<b>Luminance</b>	800 cd/m <sup>2</sup> (typ.) for G1050S
<b>Contrast Ratio</b>	600 :1
<b>View Angle (U/D/R/L)</b>	89°/89°/89°/89°
<b>Backlight Type</b>	LED

### Touch Screen

<b>Type</b>	Analog Resistive Touch for G1050/G1050S
	Projected Capacitive Touch for G1050C
<b>Light Transparency</b>	80% (typ.)
<b>Controller Interface</b>	USB Interface

### Power Supply

<b>Adapter Input</b>	100 ~ 240VAC (Full Range)
<b>Adapter Output</b>	19VDC, 3.42A, 65W
<b>Battery Type</b>	Li-battery pack
<b>Battery Capacity</b>	1 x 1880mAh 3-cell internal battery pack
	1 x 2500mAh 4-cell external battery pack
<b>Battery Operating Time</b>	8 hours (typ.)

### Mechanical & Environmental

<b>Operating Temp.</b>	-20 ~ 45°C (-4 ~ 113°F)
<b>Storage Temp.</b>	-20 ~ 60°C (-4 ~ 140°F)
<b>Discharging Temp.</b>	-20 ~ 45°C (-4 ~ 113°F)
<b>Charging Temp.</b>	0 ~ 40°C (32 ~ 104°F)
<b>Operating Humidity</b>	10 ~ 95% @ 45°C (non-condensing)
<b>Dimensions (W x D x H)</b>	205 x 294 x 25 mm (8.07" x 11.57" x 0.98")
<b>Gross Weight</b>	1.1 kg (2.2 lb) for G1050-Lite
<b>Vibration</b>	3 Grms/ 5 ~ 500Hz/ random operation
<b>Shock</b>	40G peak acceleration (11 ms duration)
<b>Transit Drop</b>	4 ft., except the front side
<b>IP Rating</b>	IP54 (whole unit)
<b>Regulatory</b>	CE/FCC Class B

### OS Support

Windows 7 Embedded / Windows 7 Professional  
Windows XP Embedded / Windows XP Professional

### Ordering Information

<b>G1050-Full</b>	10.4" Intel® Atom™ Z530P rugged tablet PC with dual battery packs, camera, Bluetooth, WiFi, HSUPA, RFID reader and barcode scanner
<b>G1050-Lite</b>	10.4" Intel® Atom™ Z530P rugged tablet PC with external battery pack and WiFi
<b>G1050S-Full</b>	10.4" Intel® Atom™ Z530P rugged tablet PC with dual battery packs, camera, Bluetooth, WiFi, HSUPA, RFID reader, barcode scanner and sunlight readable display
<b>G1050S-Lite</b>	10.4" Intel® Atom™ Z530P rugged tablet PC with external battery pack, WiFi and sunlight readable display
<b>G1050C</b>	10.4" Intel® Atom™ Z530P rugged tablet PC with projected capacitive touch screen, dual battery packs, camera, WiFi and Bluetooth

All specifications are subject to change without notice.



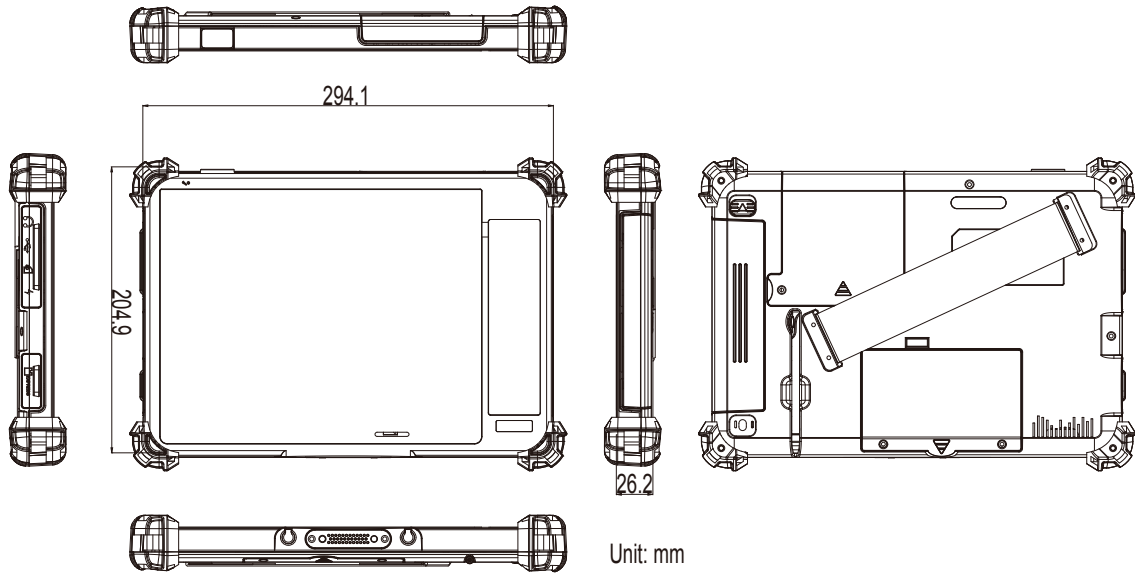





## Dimensions



### Standard Accessories

<b>Power Adapter</b>	19V/3.42A 65W AC/DC Adapter Kit	
<b>Hand Strap</b>	212mm Black Elastic Hand Strap	
<b>Stylus</b>	For Touch Screen	
<b>eBAT-1050</b>	2500mAh External Battery Pack	

### Optional Accessories

<b>Power Adapter</b>	19V/3.42A 65W AC/DC Adapter Kit	
<b>SST-0720</b>	Shoulder Strap, 128 x 3.7cm	
<b>eBAT-1050</b>	2500mAh External Battery Pack	
<b>iBAT-1040</b>	3-Cell 1880mAh Internal Battery kit	
<b>NST-1050</b>	Neck Strap, 120 x 4 x 0.6 cm	
<b>VSB-100</b>	VESA-75 to VESA-100 Adapter Bracket	
<b>VMB-1050</b>	VESA Mount Bracket for G1050	
<b>DTC-1050</b>	Desktop Cradle for G1050/G1050S	
<b>CHR-1050</b>	Dual-Bay External Battery Charger	

### Optional Configuration (CTOS\* Kit)

<b>UDG-1050</b>	USB Dongle Kit	
<b>RFID-1050</b>	13.56MHz RFID Kit	
<b>BarC-1050</b>	1D/2D Barcode Scanner Kit	
<b>HSUPA-1050</b>	3.75G HSUPA Wireless Kit	
<b>GRS-1050</b>	GPS and RS-232 2in1 Kit	
<b>SRS-1050</b>	Smart Card Reader and RS-232 2in1 Kit	
<b>MSR-1050</b>	MSR Module Kit	

\*CTOS means Configure-to-Order Service.

\*The GRS, SRS and MSR cannot co-exist on the computer as they occupy the same installation position. Please select any one of them.

All specifications are subject to change without notice.



## Стандарт Электрон Связь

Мы молодая и активно развивающаяся компания в области поставок электронных компонентов. Мы поставляем электронные компоненты отечественного и импортного производства напрямую от производителей и с крупнейших складов мира.

Благодаря сотрудничеству с мировыми поставщиками мы осуществляем комплексные и плановые поставки широчайшего спектра электронных компонентов.

Собственная эффективная логистика и склад в обеспечивает надежную поставку продукции в точно указанные сроки по всей России.

Мы осуществляем техническую поддержку нашим клиентам и предпродажную проверку качества продукции. На все поставляемые продукты мы предоставляем гарантию .

Осуществляем поставки продукции под контролем ВП МО РФ на предприятия военно-промышленного комплекса России , а также работаем в рамках 275 ФЗ с открытием отдельных счетов в уполномоченном банке. Система менеджмента качества компании соответствует требованиям ГОСТ ISO 9001.

Минимальные сроки поставки, гибкие цены, неограниченный ассортимент и индивидуальный подход к клиентам являются основой для выстраивания долгосрочного и эффективного сотрудничества с предприятиями радиоэлектронной промышленности, предприятиями ВПК и научно-исследовательскими институтами России.

С нами вы становитесь еще успешнее!

### Наши контакты:

**Телефон:** +7 812 627 14 35

**Электронная почта:** [sales@st-electron.ru](mailto:sales@st-electron.ru)

**Адрес:** 198099, Санкт-Петербург,  
Промышленная ул, дом № 19, литера Н,  
помещение 100-Н Офис 331