

# tBOX500-510-FL

Fanless Embedded System with 7th Gen Intel® Core™ i7/i5/i3 & Celeron® Processor for Railway, Vehicle and Marine PC

## Features

- CE, LVD, FCC, EN 50155, EN 45545-2, and IEC 60945 certified; ISO 7637-2 compliant
- 7th gen Intel® Core™ i7/i5/i3 or Celeron® processor (Kaby Lake)
- Power supply:
  - 24 to 110 VDC for Railway version
  - 12/24 VDC for Vehicle version
  - 24 VDC for Marine version
- External PoE PSU (optional), up to 120W power supply
- Value-added modules available for various I/O requirements (COM/LAN/DIO/PoE/CAN/BNC)
- Intelligent solution of vehicle power management (ACC ignition)
- 2 swappable 2.5" SATA drives

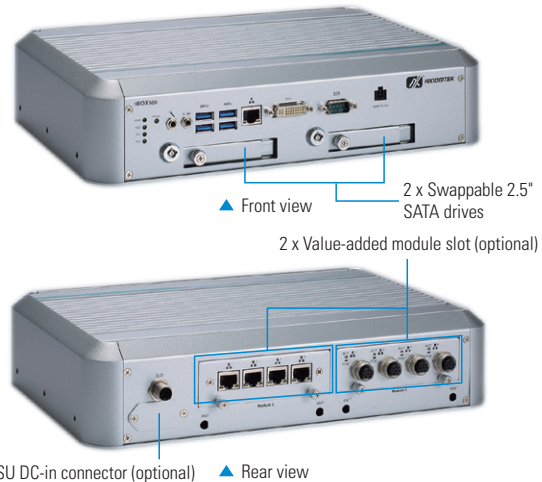



## Specifications

Standard Color	Silver
Construction	Aluminum extrusion and heavy-duty steel, IP30
CPU	Intel® Core™ i7-7600U 2C@2.8 GHz, TDP: 15W Intel® Core™ i5-7300U 2C@2.6 GHz, TDP: 15W Intel® Core™ i3-7100U 2C@2.4 GHz, TDP: 15W Intel® Celeron® 3965U 2C@2.2 GHz, TDP: 15W
Chipset	SoC integrated
System Memory	2 x DDR4-1866/2133 SO-DIMM, up to 32GB
BIOS	AMI
TPM	TPM 2.0 (optional)
System I/O Outlets	Serial 1 x DB9 serial console or RS-232/422/485 Display 1 x DVI-I (up to 1920 x1200 @60Hz, 1 x VGA & 1 x DVI included) Audio 1 x Mic-in, 1 x Line-out Ethernet 1 x RJ-45 10/100/1000 Mbps Ethernet (Intel® i210-IT) USB 4 x USB 3.0 Others 1 x Reset button 1 x Remote switch 4 x Antenna opening
Expansion Interface	3 x Full-size Rev.1.2 PCI Express Mini Card slot • 1 x mSATA/PCIe • 2 x USB/PCIe with SIM socket 2 x Value-added module slot
Storage	SATA Drive 2 x Swappable 2.5" SATA drive (9.5 mm height), Intel® RAID 0/1 supported mSATA 1 x mSATA (occupied 1 x PCI Express Mini Card slot)
Watchdog Timer	255 levels, 1 to 255 sec.
Power	Power Supply Railway: 1 x M12, 24 to 110 VDC Vehicle: 1 x terminal block, 12/24 VDC with ACC ignition Marine: 1 x terminal block, 24 VDC Power Consumption 24V - 110V, 3A - 0.6A
PoE (PSE, Power Sourcing Equipment)	PoE Power Source 1 x Terminal block PoE power-in with PSU120-259 (optional, see ordering info) PoE Performance Up to 8 x configurable M12/RJ-45 PoE output max. 120W supports PoE & PoE+ • PoE (802.3af 15.4W/port) • PoE+ (802.3at 30W/port) To be used with VAM PoE and PSU120-259 series (optional, see ordering info)

System Indicator	1 x LED indicator for power 1 x LED indicator for SATA drive activity 2 x Programmable
Operating Temperature	-40°C to +70°C (-40°F to +158°F) with W.T. peripheral* -40°C to +60°C (-40°F to +140°F) with external PoE PSU & W.T. peripheral
Humidity	0% to 95%, non-condensing
Dimensions	321 mm (12.64") (W) x 210.2 mm (8.28") (D) x 73.3 mm (2.89") (H) (without wall mount)
Mounting	Wall mount
Weight	3.5 kg (7.72 lb)/5.1 kg (11.24 lb)
Certifications	CE (Class A), LVD, FCC (Class A), EN 50155, EN 45545-2**, and IEC 60945 certified; ISO 7637-2 compliant
EMC	CE/FCC EN 61000-6-4 (Class A), EN 61000-6-2, FCC part 15 B (Class A) EN 50155 EN 50121-3-2, IEC 62236-3-2 IEC 60945 IEC 61000-4-2, IEC 61000-4-3, IEC 61000-4-4, IEC 61000-4-5, IEC 61000-4-6, CISPR 16-1-1, CISPR 16-1-2, CISPR 16-1-4
LVD	EN 60950-1
Vibration Endurance	3 Grms w/ SSD (5 to 500Hz, X/Y/Z direction; random, operating) 1.5 Grms w/ HDD (5 to 500Hz, X/Y/Z direction; random, operating) 2 Grms w/ HDD & Anti-Vibration Kit (5 to 500Hz, X/Y/Z direction; random, operating) MIL-STD-810G, Method 514.6C-VI Category 4 compliant EN 50155 EN 61373 category 1 class B IEC 60945 IEC 60068-2-6
Shock	EN 50155 EN(IEC) 61373 category 1 class B, half-sine pulse, 5g, 30ms (longitudinal direction), 3g, 30ms (vertical/transverse direction)
EOS Support	Windows® 10 64-bit, Ubuntu 16.04
Software Support	AMS.AXView

\*Wide Temperature. All W.T. supported products have to be sorted by Axiomtek.  
\*\*For EN45545-2, test report is available exclusively

## Ordering Information









System	
tBOX500-510-FL-Celeron/i3/i5/i7-24-110MRDC (P/N: E26N500100) for i7-7600U (P/N: E26N500101) for i5-7300U (P/N: E26N500102) for i3-7100U (P/N: E26N500103) for 3965U	Fanless railway embedded system, Intel® Celeron® 3965U/Core™ i3-7100U/i5-7300U/ i7-7600U processor, 4 USB 3.0, DVI-I, LAN, serial console or RS-232/422/485, Mic-in & Line-out, two 2.5" SATA trays, M12 A-code DC-in, and 24 to 110 VDC 
tBOX500-510-FL-Celeron/i3/i5/i7-TVDC (P/N: E26N500104) for i7-7600U (P/N: E26N500105) for i5-7300U (P/N: E26N500106) for i3-7100U (P/N: E26N500107) for 3965U	Fanless vehicle embedded system, Intel® Celeron® 3965U/Core™ i3-7100U/i5-7300U/ i7-7600U processor, 4 USB 3.0, DVI-I, LAN, serial console or RS-232/422/485, Mic-in & Line-out, two 2.5" SATA trays, terminal block DC-in, and ACC ignition *Not supporting PoE function 
tBOX500-510-FL-Celeron/i3/i5/i7-TMDC (P/N: E26N500108) for i7-7600U (P/N: E26N500109) for i5-7300U (P/N: E26N500110) for i3-7100U (P/N: E26N500111) for 3965U	Fanless marine embedded system, Intel® Celeron®/3965U/Core™ i3-7100U/i5-7300U/ i7-7600U processor, 4 USB 3.0, DVI-I, LAN, serial console or RS-232/422/485, Mic-in & Line-out, two 2.5" SATA trays, and terminal block DC-in 

\*MRDC: M12 DC-in connector, railway SKU, DC voltage input

\*TVDC: Terminal block DC-in connector, vehicle SKU, DC voltage input

\*TMDC: Terminal block DC-in connector, marine SKU, DC voltage input

### Value-Added Modules (VAMs) & PSU120-259

VAM100 (P/N: E277100100)	4 x Terminal block 4-wire isolated RS-232/422/485 COM Isolation voltage: 2 kV 
VAM101 (P/N: E277101100)	4 x Terminal block isolated CANbus 2.0A/B Isolation voltage: 2 kV 
VAM200 (P/N: E277200100)	1 x Terminal block isolated DIO 8-in/8-out Isolation voltage: 2 kV 
VAM400 (P/N: E277400100)	4 x BNC video-in & 1 x BNC audio-in • Supports FPS: NTSC/PAL (up to 120fps @960/720 x 480 / 100fps @960/720 x 576), H.264 video recording 2 x Full size Rev. 1.2 PCI Express Mini Card slot • 1 x USB with SIM socket • 1 x USB/PCIe with SIM socket (occupied by 1 x Capture Card) 
VAM600 (P/N: E277600100)	2 x Full size Rev. 1.2 PCI Express Mini Card slot • 1 x USB/PCIe with SIM socket • 1 x USB with SIM socket 4 x Antenna opening 
VAM700/VAM701 (P/N: E277700100/E277701100)	VAM700/701(PoE): 4 x M12 A-code GbE (PoE optional*) 
VAM702/VAM703 (P/N: E277702100/E277703100)	VAM702/703(PoE): 4 x RJ-45 GbE (PoE optional*) 
VAM704/VAM705 (P/N: E277704100/E277705100)	VAM704/705(PoE): 4 x M12 D-code 10/100 Mbps Ethernet (PoE optional*) 
VAM706/VAM707 (P/N: E277706100/E277707100)	VAM706/707(PoE): 4 x M12 X-code GbE (PoE optional*) *PSU120-259 is required if select VAM701/703/705/707
VAM900 (P/N: E277900100)	2 x Full-size Rev.1.2 PCI Express Mini Card slot • 2 x USB with SIM socket 1 x Half-size Rev.1.2 PCI Express Mini Card slot • 1 x PCIe 1 x Terminal block 4-wire isolated RS-232/422/485 COM (isolation Voltage: 2 kV) 1 x Terminal block isolated CANbus 2.0A/B (isolation Voltage: 2 kV) 1 x Terminal block isolated DIO 8-in/8-out (isolation Voltage: 1.5 kV) 

PSU120-259 series Railway-24VDC (P/N: E276120101) Railway-48VDC (P/N: E276120102) Railway-96/110VDC (P/N: E276120103) Marine-24VDC (P/N: E276120104)	Fanless IEC 60945 certified/EN 50155 compliant DC-DC adapter • Supports 24/48/96/110V-in • Power output max. 120W • -40°C to +60°C (-40°F to +140°F) 
--	---

### Optional

Anti-vibration Kit (P/N: 8816N5008A0E)	For in-vehicle/rolling stock which improves HDD stability in NVR applications 
Communication Modules	8816N3239A0E 3G UC20GKit for tBOX/UST (3G ANT) (E) 8816N3235A0E 3G/GPS UC20GKit tBOX/UST (3G/GPS ANT) (E) 8816N5003A0E AP12356 WT Wi-Fi kit for tBOX/UST SFP (E) 8816N5000A0E LTE SIM7100JC kit for tBOX, JPN SFP (E) 88160620BA0E LTE SIMCOM SIM7100 (EU) for tBOX/UST SFP (E)
AC to DC Adapter	8816N5004A0E LTE+GPS SIM7100C (TW) kit tBOX (30) SFP (E) 50906D24000E Adapter 24V/120W, wire only, FSP120-AAAN3 50966224010E Adapter 24V 90W, M12 A-code 5P FSP090AAAN3

\*Specifications and certifications may vary based on different requirements.

## Power Protection

OCP (over current protection)

OVP (over voltage protection)

UVP (under voltage protection)

RPP (reverse polarity protection)

ISO 7637-2 pulse 1, 2a, 2b, 3a, 3b, 4 (vehicle version)

Setting for in-vehicle battery protection: system will be automatically turned down at low voltage level

Setting for ignition control: system will activate a counter while in-vehicle battery at low voltage, ACC-ON delay and shut down delay

## Dimensions

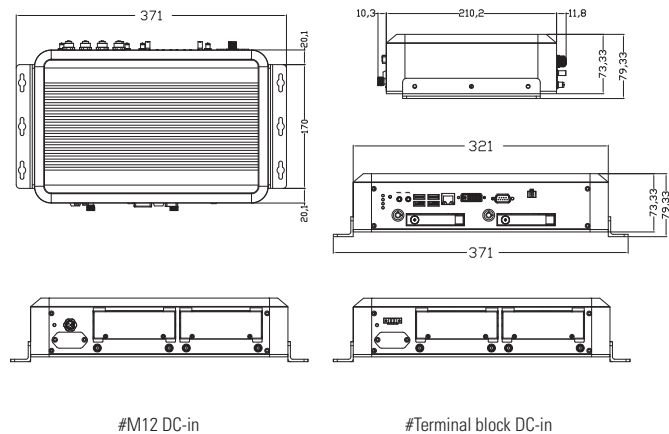



## Стандарт Электрон Связь

Мы молодая и активно развивающаяся компания в области поставок электронных компонентов. Мы поставляем электронные компоненты отечественного и импортного производства напрямую от производителей и с крупнейших складов мира.

Благодаря сотрудничеству с мировыми поставщиками мы осуществляем комплексные и плановые поставки широчайшего спектра электронных компонентов.

Собственная эффективная логистика и склад в обеспечивает надежную поставку продукции в точно указанные сроки по всей России.

Мы осуществляем техническую поддержку нашим клиентам и предпродажную проверку качества продукции. На все поставляемые продукты мы предоставляем гарантию .

Осуществляем поставки продукции под контролем ВП МО РФ на предприятия военно-промышленного комплекса России , а также работаем в рамках 275 ФЗ с открытием отдельных счетов в уполномоченном банке. Система менеджмента качества компании соответствует требованиям ГОСТ ISO 9001.

Минимальные сроки поставки, гибкие цены, неограниченный ассортимент и индивидуальный подход к клиентам являются основой для выстраивания долгосрочного и эффективного сотрудничества с предприятиями радиоэлектронной промышленности, предприятиями ВПК и научно-исследовательскими институтами России.

С нами вы становитесь еще успешнее!

### Наши контакты:

**Телефон:** +7 812 627 14 35

**Электронная почта:** [sales@st-electron.ru](mailto:sales@st-electron.ru)

**Адрес:** 198099, Санкт-Петербург,  
Промышленная ул, дом № 19, литера Н,  
помещение 100-Н Офис 331