

Utilizing the latest Field Stop and Trench Gate technologies, these IGBT's have ultra low $V_{CE(ON)}$ and are ideal for low frequency applications that require absolute minimum conduction loss. Easy paralleling is a result of very tight parameter distribution and a slightly positive $V_{CE(ON)}$ temperature coefficient. Low gate charge simplifies gate drive design and minimizes losses.

- 600V Field Stop
- Trench Gate: Low $V_{CE(on)}$
- Easy Paralleling
- 6 μ s Short Circuit Capability
- 175°C Rated

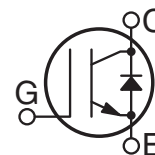
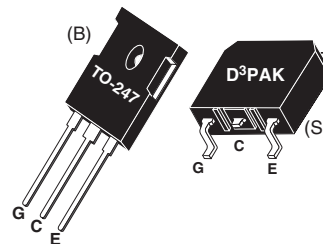

Applications: Welding, Inductive Heating, Solar Inverters, SMPS, Motor drives, UPS

MAXIMUM RATINGS

All Ratings: $T_C = 25^\circ\text{C}$ unless otherwise specified.

Symbol	Parameter	APT50GN60BD_SDQ2(G)	UNIT
V_{CES}	Collector-Emitter Voltage	600	Volts
V_{GE}	Gate-Emitter Voltage	± 30	
I_{C1}	Continuous Collector Current ^③ @ $T_C = 25^\circ\text{C}$	107	Amps
I_{C2}	Continuous Collector Current @ $T_C = 110^\circ\text{C}$	64	
I_{CM}	Pulsed Collector Current ^① @ $T_C = 175^\circ\text{C}$	150	
SSOA	Switching Safe Operating Area @ $T_J = 175^\circ\text{C}$	150A @ 600V	
P_D	Total Power Dissipation	366	Watts
T_J, T_{STG}	Operating and Storage Junction Temperature Range	-55 to 175	$^\circ\text{C}$
T_L	Max. Lead Temp. for Soldering: 0.063" from Case for 10 Sec.	300	

STATIC ELECTRICAL CHARACTERISTICS

Symbol	Characteristic / Test Conditions	MIN	TYP	MAX	Units
$V_{(BR)CES}$	Collector-Emitter Breakdown Voltage ($V_{GE} = 0V, I_C = 4mA$)	600			Volts
$V_{GE(TH)}$	Gate Threshold Voltage ($V_{CE} = V_{GE}, I_C = 800\mu A, T_j = 25^\circ\text{C}$)	5.0	5.8	6.5	
$V_{CE(ON)}$	Collector-Emitter On Voltage ($V_{GE} = 15V, I_C = 50A, T_j = 25^\circ\text{C}$)	1.05	1.45	1.85	
	Collector-Emitter On Voltage ($V_{GE} = 15V, I_C = 50A, T_j = 125^\circ\text{C}$)		1.7		
I_{CES}	Collector Cut-off Current ($V_{CE} = 600V, V_{GE} = 0V, T_j = 25^\circ\text{C}$) ^②			50	μA
	Collector Cut-off Current ($V_{CE} = 600V, V_{GE} = 0V, T_j = 125^\circ\text{C}$) ^②			TBD	
I_{GES}	Gate-Emitter Leakage Current ($V_{GE} = \pm 20V$)			600	nA
$R_{G(int)}$	Intergrated Gate Resistor		N/A		Ω



CAUTION: These Devices are Sensitive to Electrostatic Discharge. Proper Handling Procedures Should Be Followed.

DYNAMIC CHARACTERISTICS

APT50GN60BD_SDQ2(G)

Symbol	Characteristic	Test Conditions	MIN	TYP	MAX	UNIT	
C_{ies}	Input Capacitance	Capacitance $V_{GE} = 0V, V_{CE} = 25V$ $f = 1 \text{ MHz}$		3200		pF	
C_{oes}	Output Capacitance			125			
C_{res}	Reverse Transfer Capacitance			100			
V_{GEP}	Gate-to-Emitter Plateau Voltage	Gate Charge		9.0		V	
Q_g	Total Gate Charge ^③	$V_{GE} = 15V$		325		nC	
Q_{ge}	Gate-Emitter Charge	$V_{CE} = 300V$		25			
Q_{gc}	Gate-Collector ("Miller") Charge	$I_C = 50A$		175			
SSOA	Switching Safe Operating Area	$T_J = 175^\circ\text{C}, R_G = 4.3\Omega^{\text{⑦}}, V_{GE} = 15V, L = 100\mu\text{H}, V_{CE} = 600V$	150			A	
SCSOA	Short Circuit Safe Operating Area	$V_{CC} = 360V, V_{GE} = 15V, T_J = 150^\circ\text{C}, R_G = 4.3\Omega^{\text{⑦}}$	6			μs	
$t_{d(on)}$	Turn-on Delay Time	Inductive Switching (25°C) $V_{CC} = 400V$ $V_{GE} = 15V$ $I_C = 50A$ $R_G = 4.3\Omega^{\text{⑦}}$ $T_J = +25^\circ\text{C}$		20		ns	
t_r	Current Rise Time			25			
$t_{d(off)}$	Turn-off Delay Time			230			
t_f	Current Fall Time			100			
E_{on1}	Turn-on Switching Energy ^④				1185		μJ
E_{on2}	Turn-on Switching Energy (Diode) ^⑤				1275		
E_{off}	Turn-off Switching Energy ^⑥				1565		
$t_{d(on)}$	Turn-on Delay Time	Inductive Switching (125°C) $V_{CC} = 400V$ $V_{GE} = 15V$ $I_C = 50A$ $R_G = 4.3\Omega^{\text{⑦}}$ $T_J = +125^\circ\text{C}$		20		ns	
t_r	Current Rise Time			25			
$t_{d(off)}$	Turn-off Delay Time			260			
t_f	Current Fall Time			140			
E_{on1}	Turn-on Switching Energy ^④				1205		μJ
E_{on2}	Turn-on Switching Energy (Diode) ^⑤				1850		
E_{off}	Turn-off Switching Energy ^⑥				2125		

THERMAL AND MECHANICAL CHARACTERISTICS

Symbol	Characteristic	MIN	TYP	MAX	UNIT
$R_{\theta JC}$	Junction to Case (IGBT)			.41	°C/W
$R_{\theta JC}$	Junction to Case (DIODE)			.67	
W_T	Package Weight		5.9		gm

① Repetitive Rating: Pulse width limited by maximum junction temperature.

② For Combi devices, I_{ces} includes both IGBT and FRED leakages

③ See MIL-STD-750 Method 3471.

④ E_{on1} is the clamped inductive turn-on energy of the IGBT only, without the effect of a commutating diode reverse recovery current adding to the IGBT turn-on loss. Tested in inductive switching test circuit shown in figure 21, but with a Silicon Carbide diode.

⑤ E_{on2} is the clamped inductive turn-on energy that includes a commutating diode reverse recovery current in the IGBT turn-on switching loss. (See Figures 21, 22.)

⑥ E_{off} is the clamped inductive turn-off energy measured in accordance with JEDEC standard JESD24-1. (See Figures 21, 23.)

⑦ R_G is external gate resistance, not including $R_{G(int)}$ nor gate driver impedance. (MIC4452)

⑧ Continuous current limited by package lead temperature.

Microsemi Reserves the right to change, without notice, the specifications and information contained herein.

TYPICAL PERFORMANCE CURVES

APT50GN60BD_SDQ2(G)

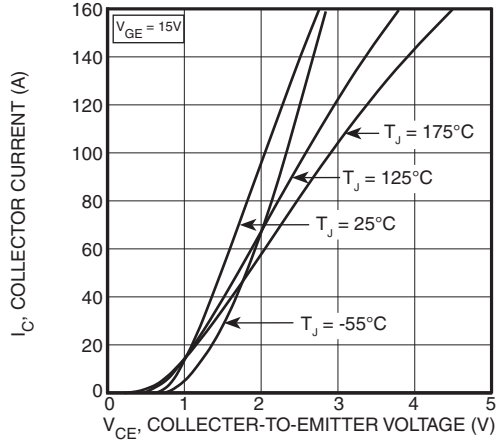

FIGURE 1, Output Characteristics ($T_J = 25^\circ\text{C}$)

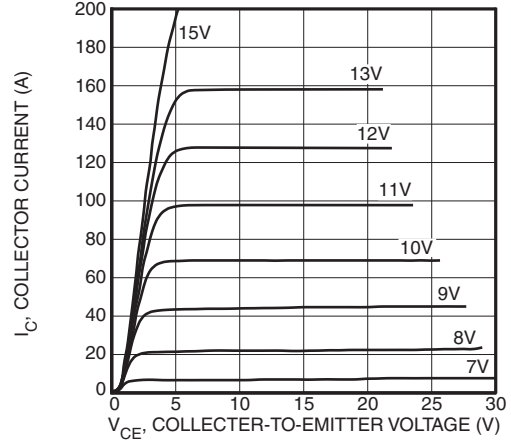

FIGURE 2, Output Characteristics ($T_J = 125^\circ\text{C}$)

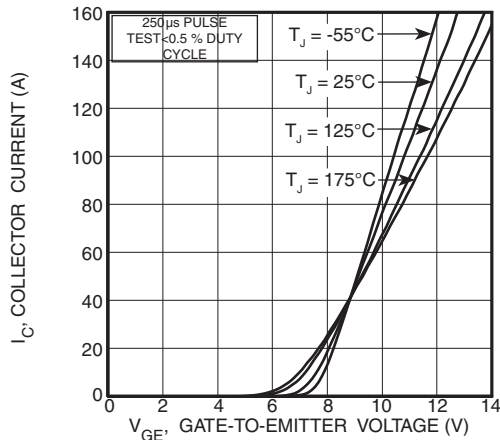

FIGURE 3, Transfer Characteristics

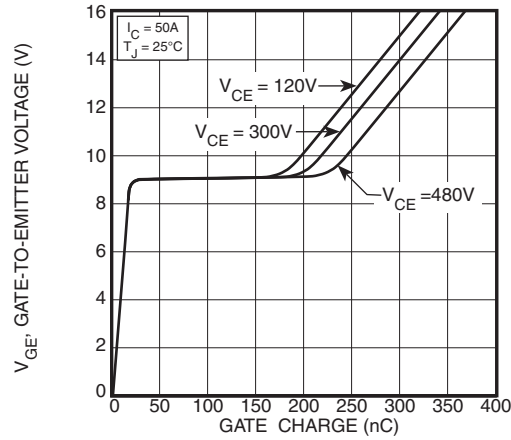

FIGURE 4, Gate Charge

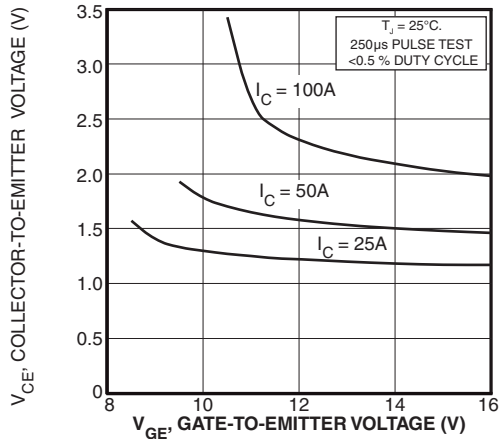

FIGURE 5, On State Voltage vs Gate-to-Emitter Voltage

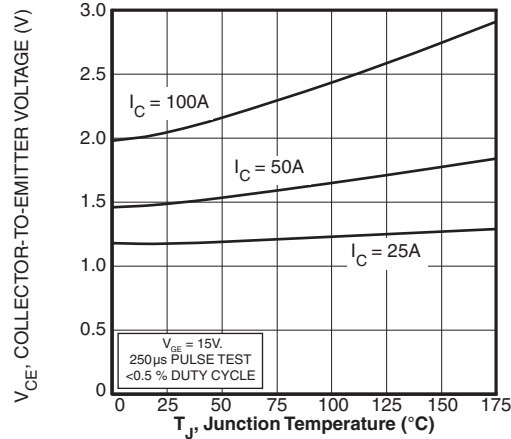

FIGURE 6, On State Voltage vs Junction Temperature

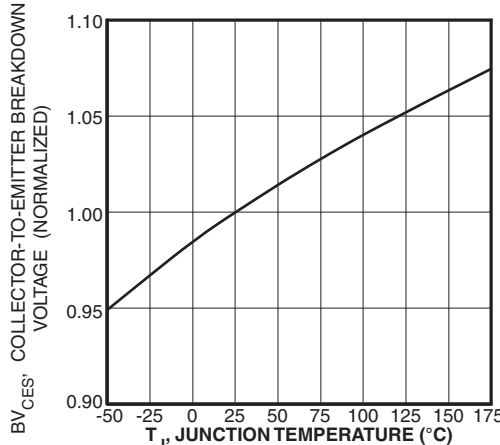

FIGURE 7, Breakdown Voltage vs. Junction Temperature

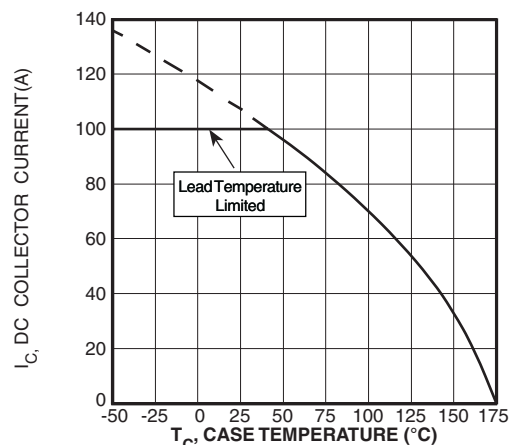

FIGURE 8, DC Collector Current vs Case Temperature

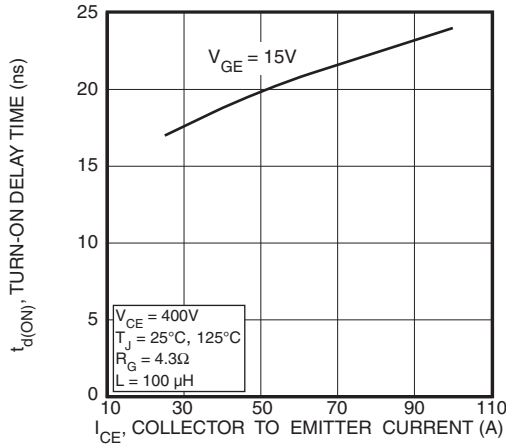

FIGURE 9, Turn-On Delay Time vs Collector Current

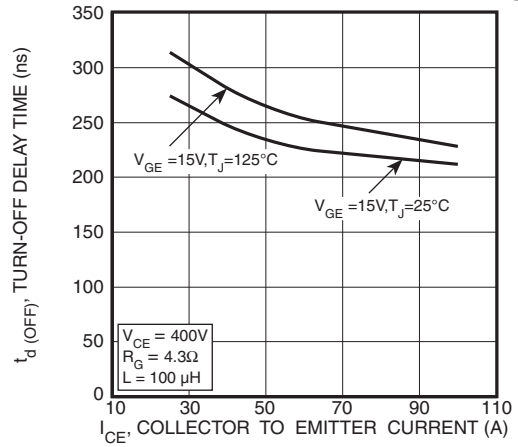

FIGURE 10, Turn-Off Delay Time vs Collector Current

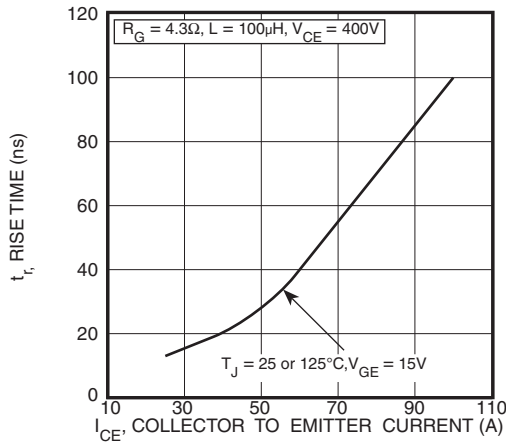

FIGURE 11, Current Rise Time vs Collector Current

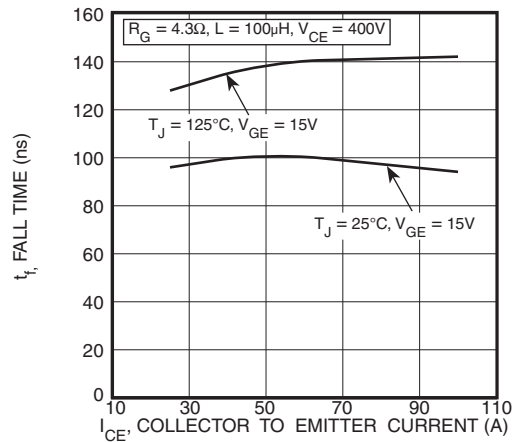

FIGURE 12, Current Fall Time vs Collector Current

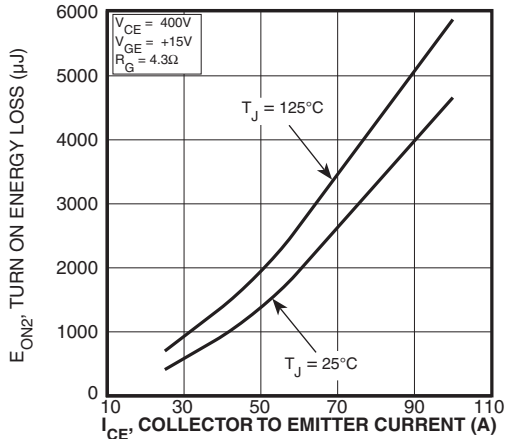

FIGURE 13, Turn-On Energy Loss vs Collector Current

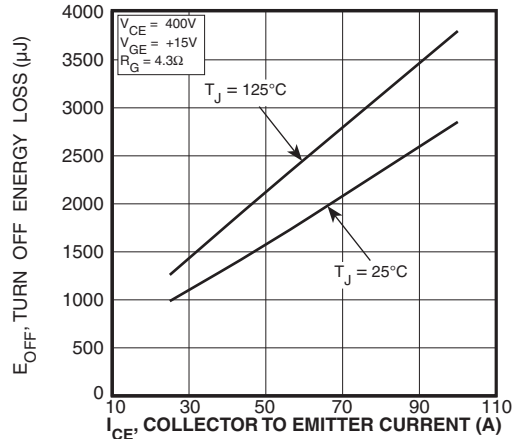

FIGURE 14, Turn Off Energy Loss vs Collector Current

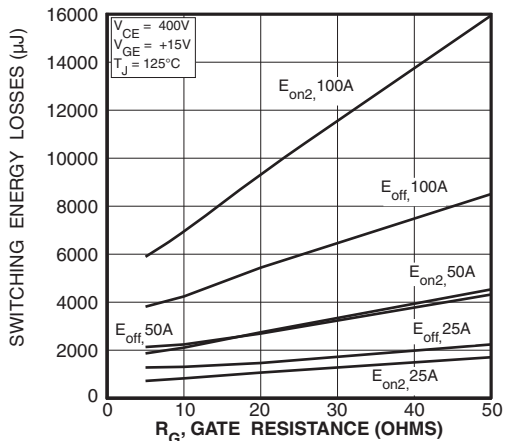

FIGURE 15, Switching Energy Losses vs. Gate Resistance

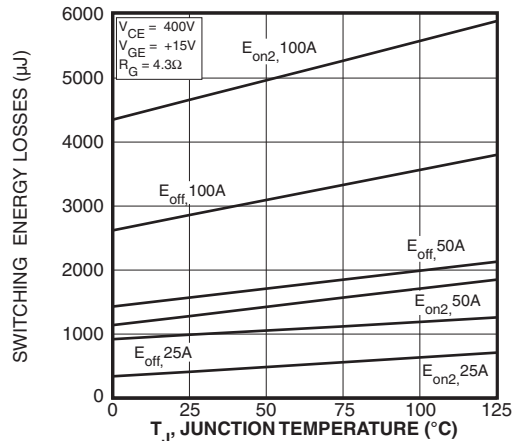

FIGURE 16, Switching Energy Losses vs Junction Temperature

TYPICAL PERFORMANCE CURVES

APT50GN60BD_SDQ2(G)

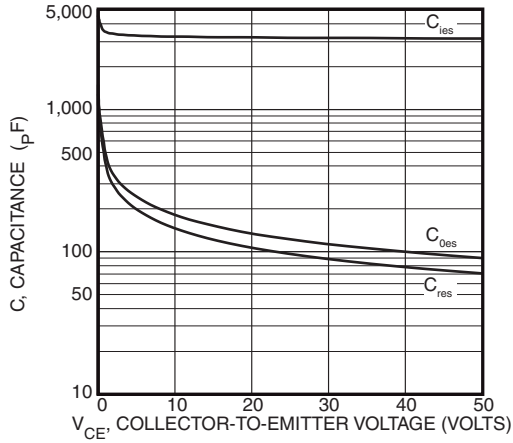

Figure 17, Capacitance vs Collector-To-Emitter Voltage

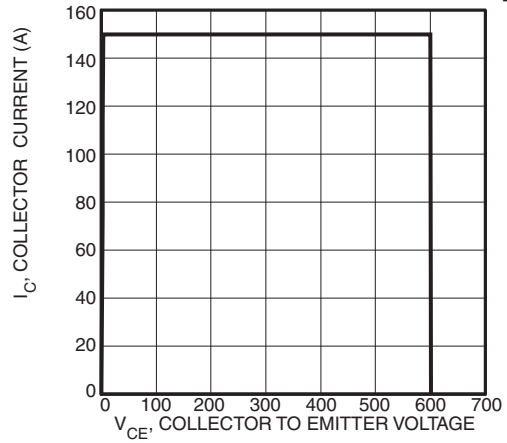

Figure 18, Minimum Switching Safe Operating Area

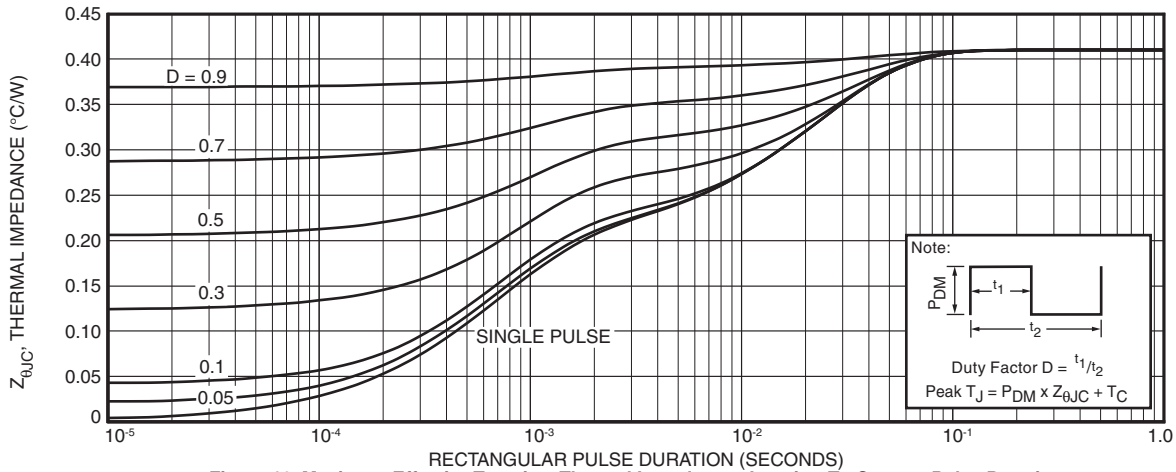

Figure 19, Maximum Effective Transient Thermal Impedance, Junction-To-Case vs Pulse Duration

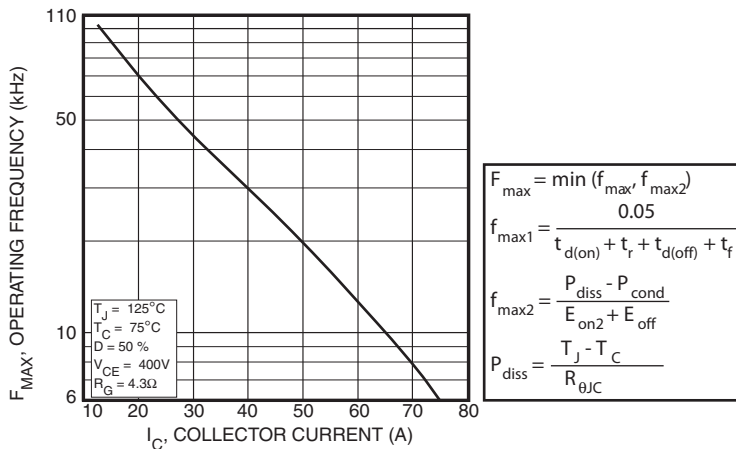

Figure 20, Operating Frequency vs Collector Current

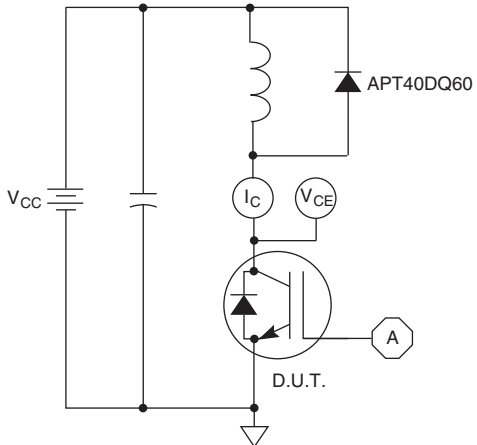

Figure 21, Inductive Switching Test Circuit

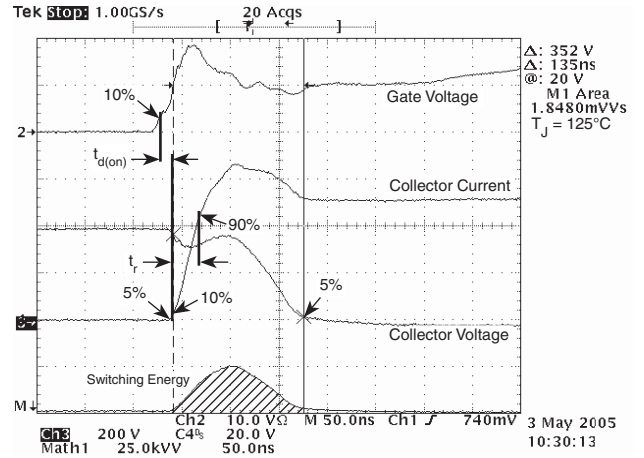

Figure 22, Turn-on Switching Waveforms and Definitions

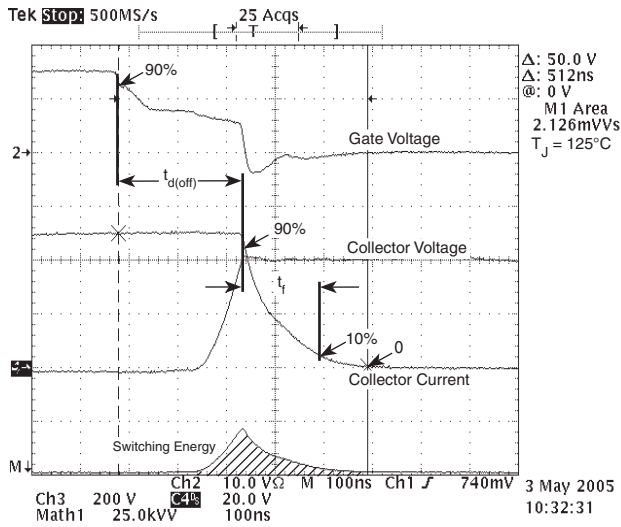

Figure 23, Turn-off Switching Waveforms and Definitions

ULTRAFAST SOFT RECOVERY ANTI-PARALLEL DIODE

MAXIMUM RATINGS

All Ratings: $T_C = 25^\circ\text{C}$ unless otherwise specified.

Symbol	Characteristic / Test Conditions	APT50GN60BD_SDQ2(G)		UNIT
$I_{F(AV)}$	Maximum Average Forward Current ($T_C = 111^\circ\text{C}$, Duty Cycle = 0.5)		40	Amps
$I_{F(RMS)}$	RMS Forward Current (Square wave, 50% duty)		63	
I_{FSM}	Non-Repetitive Forward Surge Current ($T_J = 45^\circ\text{C}$, 8.3ms)		320	

STATIC ELECTRICAL CHARACTERISTICS

Symbol	Characteristic / Test Conditions	MIN	TYP	MAX	UNIT
V_F	Forward Voltage		$I_F = 50\text{A}$	2.2	Volts
			$I_F = 100\text{A}$	2.7	
			$I_F = 50\text{A}, T_J = 125^\circ\text{C}$	1.8	

DYNAMIC CHARACTERISTICS

Symbol	Characteristic	Test Conditions	MIN	TYP	MAX	UNIT
t_{rr}	Reverse Recovery Time	$I_F = 1\text{A}, di_F/dt = -100\text{A}/\mu\text{s}, V_R = 30\text{V}, T_J = 25^\circ\text{C}$	-	22		ns
t_{rr}	Reverse Recovery Time	$I_F = 40\text{A}, di_F/dt = -200\text{A}/\mu\text{s}, V_R = 400\text{V}, T_C = 25^\circ\text{C}$	-	25		
Q_{rr}	Reverse Recovery Charge		-	35		nC
I_{RRM}	Maximum Reverse Recovery Current		-	3	-	Amps
t_{rr}	Reverse Recovery Time	$I_F = 40\text{A}, di_F/dt = -200\text{A}/\mu\text{s}, V_R = 400\text{V}, T_C = 125^\circ\text{C}$	-	160		ns
Q_{rr}	Reverse Recovery Charge		-	480		nC
I_{RRM}	Maximum Reverse Recovery Current		-	6	-	Amps
t_{rr}	Reverse Recovery Time	$I_F = 40\text{A}, di_F/dt = -1000\text{A}/\mu\text{s}, V_R = 400\text{V}, T_C = 125^\circ\text{C}$	-	85		ns
Q_{rr}	Reverse Recovery Charge		-	920		nC
I_{RRM}	Maximum Reverse Recovery Current		-	20		Amps

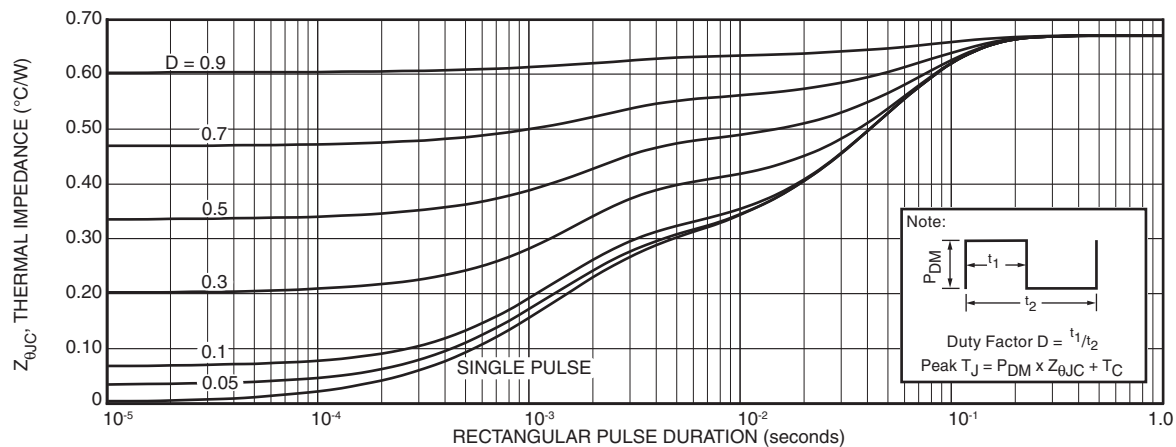

FIGURE 24. MAXIMUM EFFECTIVE TRANSIENT THERMAL IMPEDANCE, JUNCTION-TO-CASE vs. PULSE DURATION

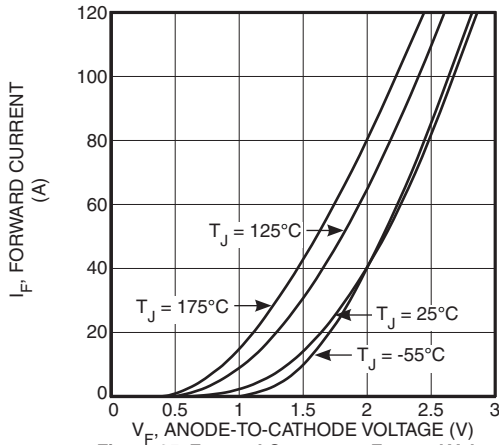

Figure 25. Forward Current vs. Forward Voltage

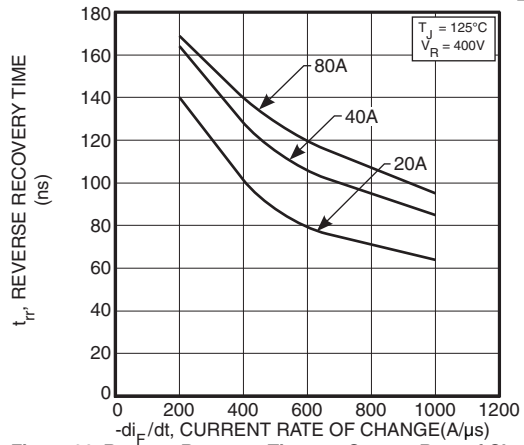

Figure 26. Reverse Recovery Time vs. Current Rate of Change

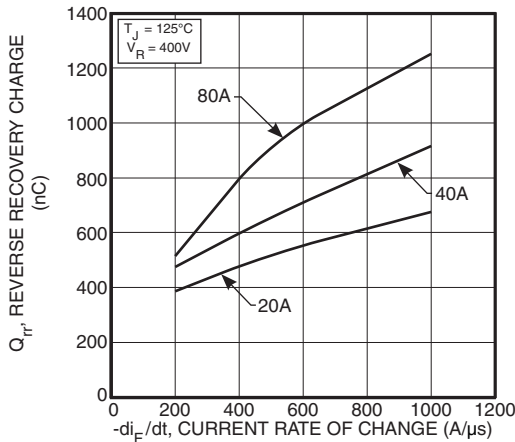

Figure 27. Reverse Recovery Charge vs. Current Rate of Change

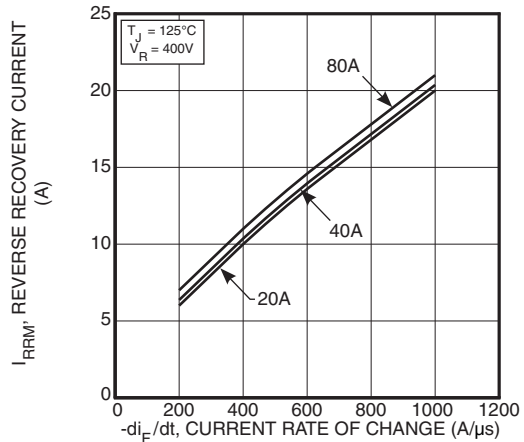

Figure 28. Reverse Recovery Current vs. Current Rate of Change

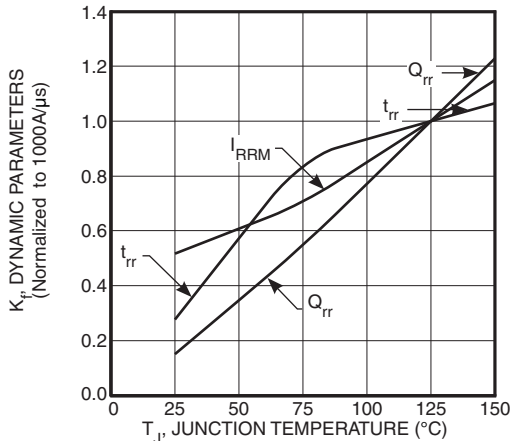

Figure 29. Dynamic Parameters vs. Junction Temperature

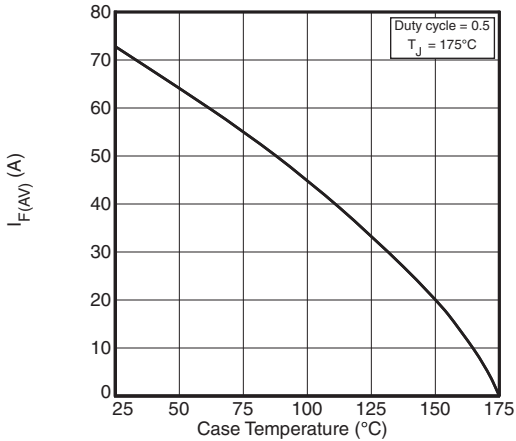

Figure 30. Maximum Average Forward Current vs. Case Temperature

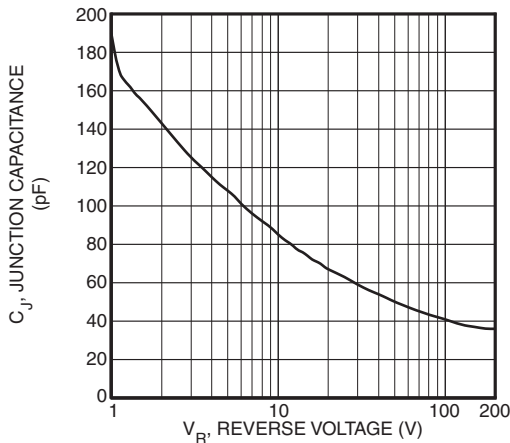

Figure 31. Junction Capacitance vs. Reverse Voltage

TYPICAL PERFORMANCE CURVES

APT50GN60BD_SDQ2(G)

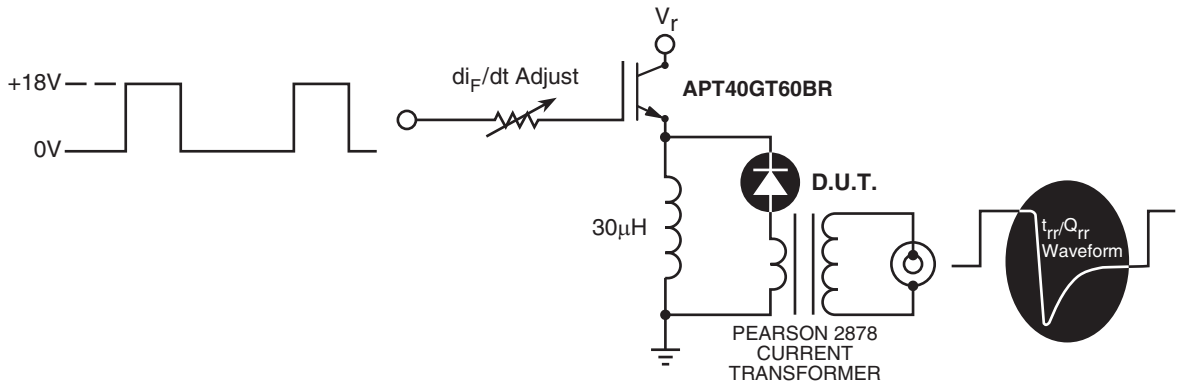

Figure 32. Diode Test Circuit

- 1 I_F - Forward Conduction Current
- 2 di_F/dt - Rate of Diode Current Change Through Zero Crossing.
- 3 I_{RRM} - Maximum Reverse Recovery Current.
- 4 t_{rr} - Reverse Recovery Time, measured from zero crossing where diode current goes from positive to negative, to the point at which the straight line through I_{RRM} and $0.25 \cdot I_{RRM}$ passes through zero.
- 5 Q_{rr} - Area Under the Curve Defined by I_{RRM} and t_{rr} .

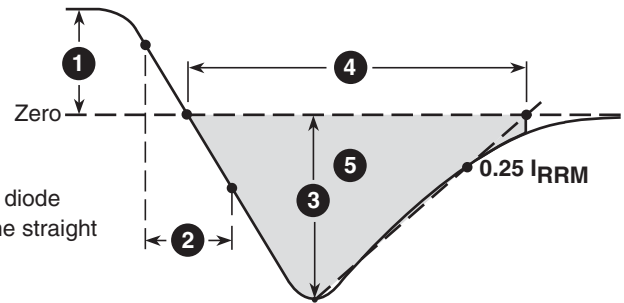
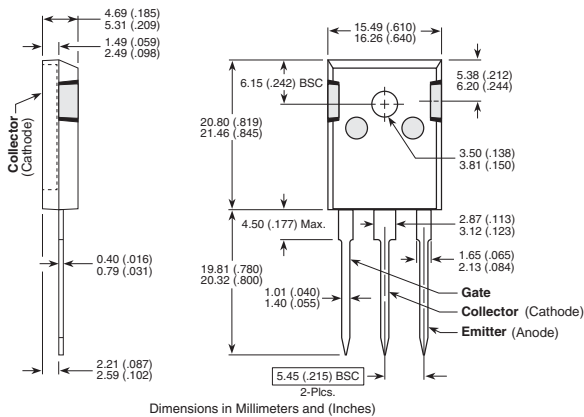

Figure 33. Diode Reverse Recovery Waveform and Definitions

TO-247 Package Outline

e1 SAC: Tin, Silver, Copper



D³PAK Package Outline

e3 SAC: Tin, Silver, Copper

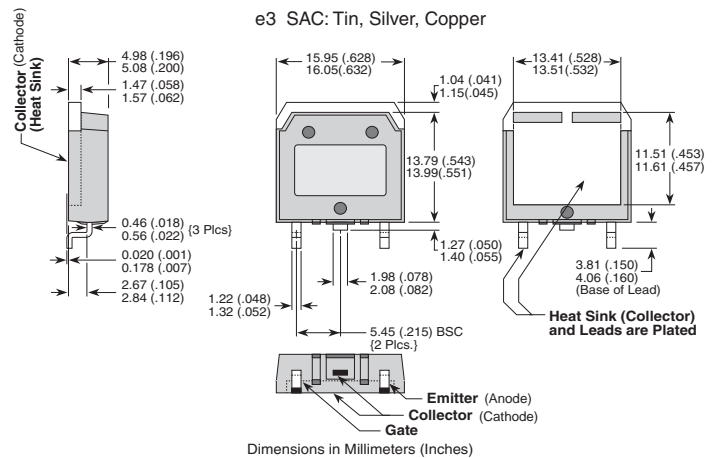

Microsemi's products are covered by one or more of U.S. patents 4,895,810 5,045,903 5,089,434 5,182,234 5,019,522 5,262,336 6,503,786 5,256,583 4,748,103 5,283,202 5,231,474 5,434,095 5,528,058 6,939,743, 7,352,045 5,283,201 5,801,417 5,648,283 7,196,634 6,664,594 7,157,886 6,939,743 7,342,262 and foreign patents. US and Foreign patents pending. All Rights Reserved.



**Стандарт
Электрон
Связь**

Мы молодая и активно развивающаяся компания в области поставок электронных компонентов. Мы поставляем электронные компоненты отечественного и импортного производства напрямую от производителей и с крупнейших складов мира.

Благодаря сотрудничеству с мировыми поставщиками мы осуществляем комплексные и плановые поставки широчайшего спектра электронных компонентов.

Собственная эффективная логистика и склад в обеспечивает надежную поставку продукции в точно указанные сроки по всей России.

Мы осуществляем техническую поддержку нашим клиентам и предпродажную проверку качества продукции. На все поставляемые продукты мы предоставляем гарантию .

Осуществляем поставки продукции под контролем ВП МО РФ на предприятия военно-промышленного комплекса России , а также работаем в рамках 275 ФЗ с открытием отдельных счетов в уполномоченном банке. Система менеджмента качества компании соответствует требованиям ГОСТ ISO 9001.

Минимальные сроки поставки, гибкие цены, неограниченный ассортимент и индивидуальный подход к клиентам являются основой для выстраивания долгосрочного и эффективного сотрудничества с предприятиями радиоэлектронной промышленности, предприятиями ВПК и научно-исследовательскими институтами России.

С нами вы становитесь еще успешнее!

Наши контакты:

Телефон: +7 812 627 14 35

Электронная почта: sales@st-electron.ru

Адрес: 198099, Санкт-Петербург,
Промышленная ул, дом № 19, литера Н,
помещение 100-Н Офис 331