

SxX8xSx Series



Main Features

| Symbol | Value | Unit |
|---------------------|------------|---------|
| $I_{T(RMS)}$ | 0.8 | A |
| V_{DRM} / V_{RRM} | 400 to 800 | V |
| I_{GT} | 5 to 200 | μ A |

Applications

The SxX8xSx EV series is specifically designed for GFCI (Ground Fault Circuit Interrupter) and gas ignition applications.

Description

New device series offers high static dv/dt and lower turn off (t_q) sensitive SCR with its small die planar construction design. It is specifically designed for GFCI (Ground Fault Circuit Interrupter) and Gas Ignition applications. All SCRs junctions are glass-passivated to ensure long term reliability and parametric stability.

Features

- RoHS compliant and Halogen-Free
- Thru-hole and surface mount packages
- Surge current capability > 10Amps
- Blocking voltage (V_{DRM} / V_{RRM}) capability - up to 800V
- High dv/dt noise immunity
- Improved turn-off time (t_q) < 25 μ sec
- Sensitive gate for direct microprocessor interface

Schematic Symbol

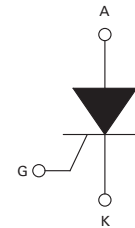

Absolute Maximum Ratings

| Symbol | Parameter | Value | Unit |
|--------------|---|--|-----------------------------|
| $I_{T(RMS)}$ | RMS on-state current (full sine wave) | TO-92 $T_c = 55^\circ\text{C}$ | 0.8 A |
| | | SOT-89 $T_c = 60^\circ\text{C}$ | 0.8 A |
| | | SOT-223 $T_L = 60^\circ\text{C}$ | 0.8 A |
| $I_{T(AV)}$ | Average on-state current | TO-92 $T_c = 55^\circ\text{C}$ | 0.51 A |
| | | SOT-89 $T_c = 60^\circ\text{C}$ | 0.51 A |
| | | SOT-223 $T_L = 60^\circ\text{C}$ | 0.51 A |
| I_{TSM} | Non repetitive surge peak on-state current (Single cycle, T_j initial = 25°C) | TO-92 $F = 50\text{Hz}$ | 8 A |
| | | SOT-89 $F = 60\text{Hz}$ SOT-223 | 10 A |
| I^2t | I^2t Value for fusing | $t_p = 10\text{ ms}$ $F = 50\text{ Hz}$ | 0.32 A^2s |
| | | $t_p = 8.3\text{ ms}$ $F = 60\text{ Hz}$ | 0.41 A^2s |
| di/dt | Critical rate of rise of on-state current $I_G = 10\text{mA}$ | TO-92 $T_j = 125^\circ\text{C}$ SOT-89 SOT-223 | 50 $\text{A}/\mu\text{s}$ |
| I_{GM} | Peak Gate Current | $t_p = 10\ \mu\text{s}$ $T_j = 125^\circ\text{C}$ | 1.0 A |
| $P_{G(AV)}$ | Average gate power dissipation | $T_j = 125^\circ\text{C}$ | 0.1 W |
| T_{stg} | Storage junction temperature range | — | -40 to 150 $^\circ\text{C}$ |
| T_j | Operating junction temperature range | — | -40 to 125 $^\circ\text{C}$ |

Electrical Characteristics (T_J = 25°C, unless otherwise specified)

| Symbol | Description | Test Conditions | Limit | Value | | | Unit |
|----------------------|--|---|-------|---------|---------|--------|------|
| | | | | SxX8yS1 | SxX8yS2 | SxX8yS | |
| I _{GT} | DC Gate Trigger Current | V _D = 6V R _L = 100 Ω | MIN. | 0.5 | 1 | 15 | μA |
| | | | MAX. | 5 | 50 | 200 | μA |
| V _{GT} | DC Gate Trigger Voltage | V _D = 6V R _L = 100 Ω | MAX. | 0.8 | | | V |
| V _{GRM} | Peak Reverse Gate Voltage | I _{RG} = 10μA | MIN. | 5 | | | V |
| I _H | Holding Current | R _{GK} = 1 kΩ Initial Current = 20mA | MAX. | 5 | | | mA |
| (dv/dt) _s | Critical Rate-of-Rise of Off-State Voltage | T _J = 125°C V _D = V _{DRM} / V _{RRM} Exp. Waveform R _{GK} = 1 kΩ | MIN. | 75 | | | V/μs |
| V _{GD} | Gate Non-Trigger Voltage | V _D = V _{DRM} R _{GK} = 1 kΩ T _J = 25°C | MIN. | 0.2 | | | V |
| t _q | Turn-Off Time | T _J = 25°C @ 600 V R _{GK} = 1 kΩ | MAX. | 30 | 25 | 25 | μs |
| t _{gt} | Turn-On Time | I _G = 10mA PW = 15μsec I _T = 1.6A(pk) | TYP. | 2.0 | 2.0 | 2.0 | μs |

Note: x = voltage, y = package

Static Characteristics (T_J = 25°C, unless otherwise specified)

| Symbol | Description | Test Conditions | Limit | Value | Unit |
|------------------|------------------------------------|--|-------|-------|------|
| V _{TM} | Peak On-State Voltage | I _{TM} = 1.6A (pk) | MAX. | 1.70 | V |
| I _{DRM} | Off-State Current, Peak Repetitive | T _J = 25°C @ V _D = V _{DRM} R _{GK} = 1 kΩ | MAX. | 3 | μA |
| | | T _J = 125°C @ V _D = V _{DRM} R _{GK} = 1 kΩ | MAX. | 500 | μA |

Thermal Resistances

| Symbol | Description | Test Conditions | Value | Unit | |
|----------------------|-----------------------|---|---------|------|------|
| R _{th(j-c)} | Junction to case (AC) | I _T = 0.8A _(RMS) ¹ | TO-92 | 75 | °C/W |
| | | | SOT-223 | 30 | °C/W |
| | | | SOT-89 | 50 | °C/W |
| R _{th(j-a)} | Junction to ambient | I _T = 0.8A _(RMS) ¹ | TO-92 | 150 | °C/W |
| | | | SOT-223 | 60 | °C/W |
| | | | SOT-89 | 90 | °C/W |

¹ 60Hz AC resistive load condition, 100% conduction.

Figure 1: Normalized DC Gate Trigger Current For All Quadrants vs. Junction Temperature

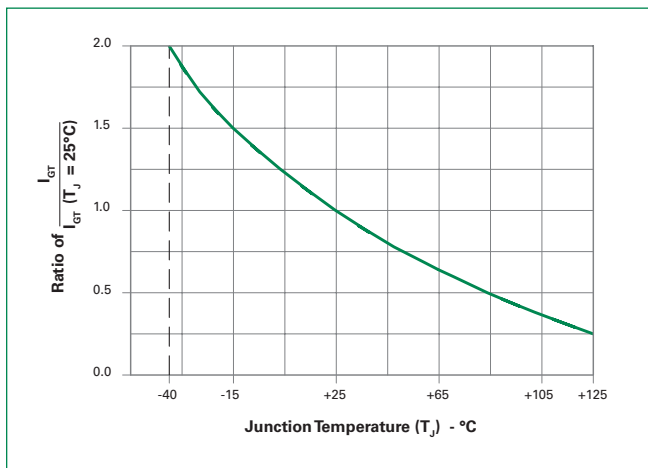

Figure 2: Normalized DC Holding Current vs. Junction Temperature

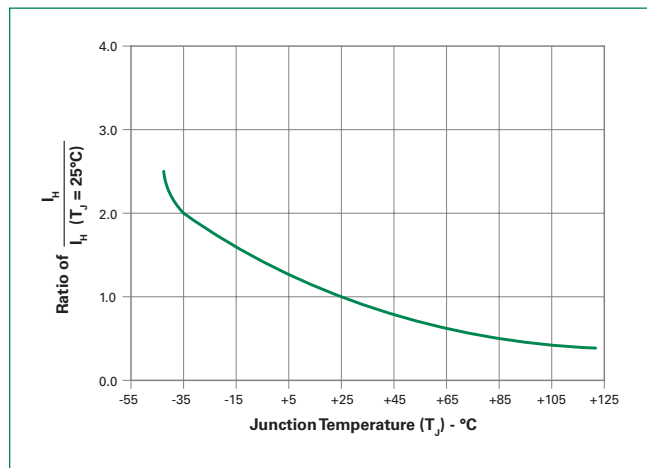

Figure 3: Normalized DC Gate Trigger Voltage vs. Junction Temperature

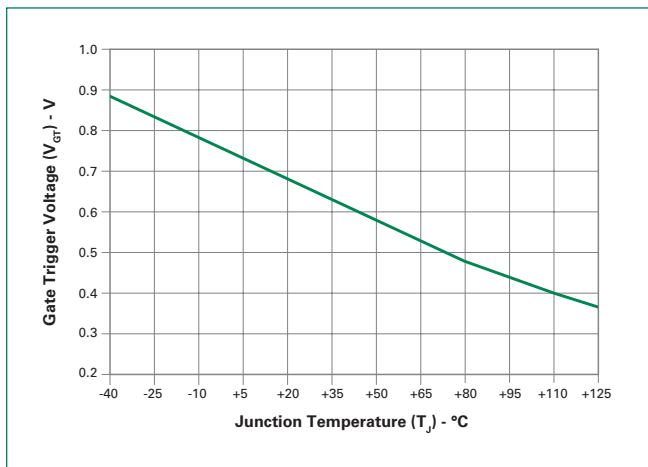

Figure 4: Power Dissipation (Typical) vs. RMS On-State Current

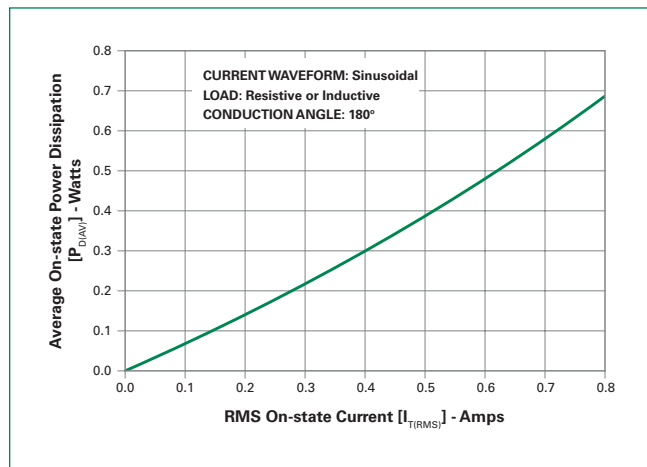

Figure 5: Maximum Allowable Case Temperature vs. On-State Current

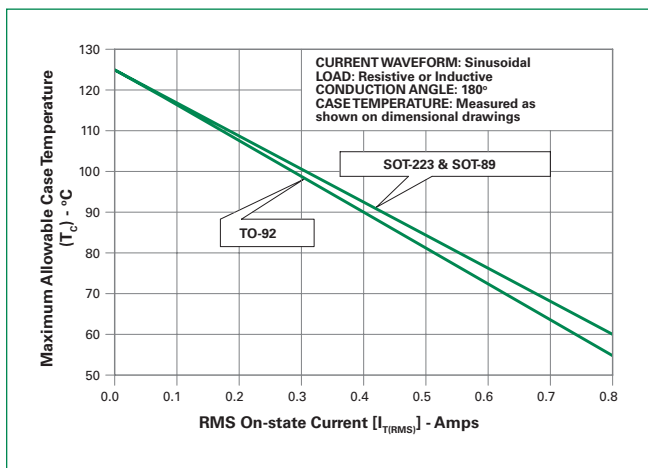
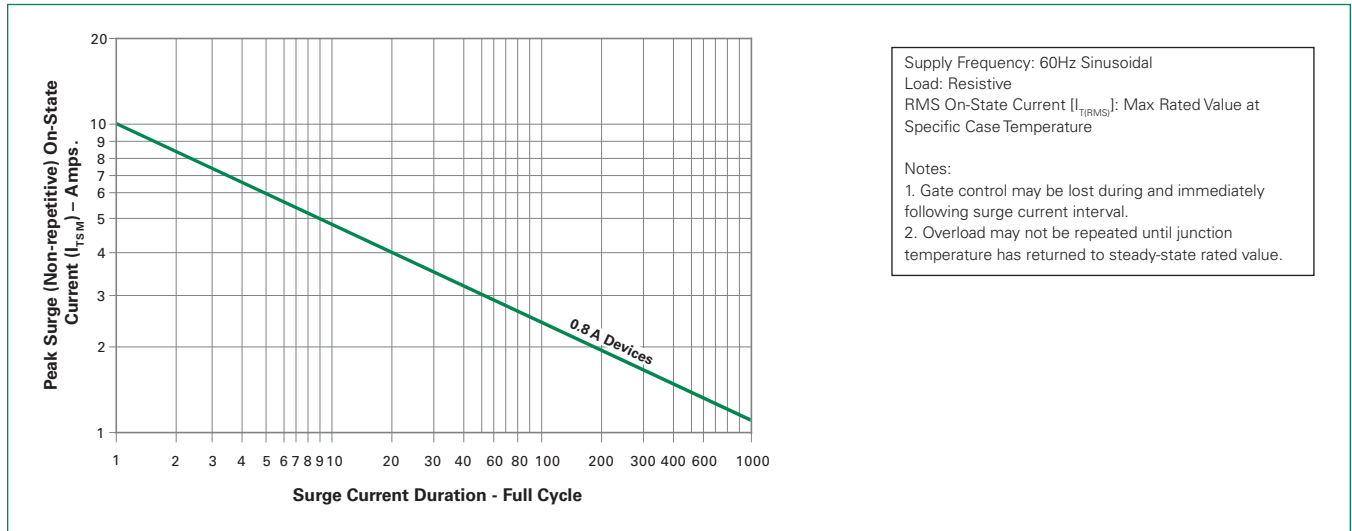
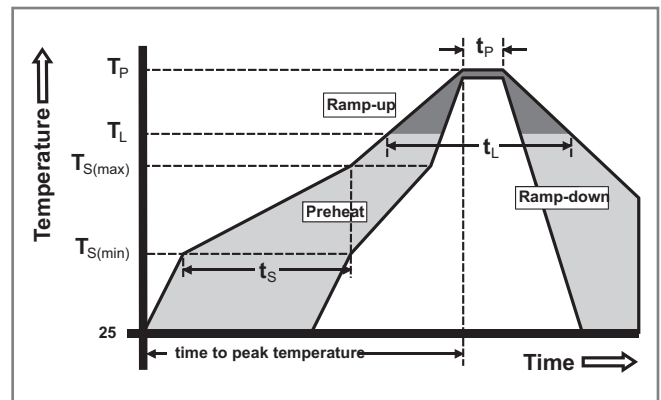

Figure 6: Surge Peak On-State Current vs. Number of Cycles



Soldering Parameters

| | | |
|--|------------------------------------|-------------------------|
| Reflow Condition | | Pb – Free assembly |
| Pre Heat | - Temperature Min ($T_{s(min)}$) | 150°C |
| | - Temperature Max ($T_{s(max)}$) | 200°C |
| | - Time (min to max) (t_s) | 60 – 180 secs |
| Average ramp up rate (Liquidus Temp) (T_L) to peak | | 5°C/second max |
| $T_{s(max)}$ to T_L - Ramp-up Rate | | 5°C/second max |
| Reflow | - Temperature (T_L) (Liquidus) | 217°C |
| | - Time (min to max) (t_s) | 60 – 150 seconds |
| Peak Temperature (T_p) | | 260 ^{+0/-5} °C |
| Time within 5°C of actual peak Temperature (t_p) | | 20 – 40 seconds |
| Ramp-down Rate | | 5°C/second max |
| Time 25°C to peak Temperature (T_p) | | 8 minutes Max. |
| Do not exceed | | 280°C |



Physical Specifications

| | |
|------------------------|--|
| Terminal Finish | 100% Matte Tin-plated. |
| Body Material | UL recognized epoxy meeting flammability classification 94V-0. |
| Lead Material | Copper Alloy |

Design Considerations

Careful selection of the correct device for the application's operating parameters and environment will go a long way toward extending the operating life of the Thyristor. Good design practice should limit the maximum continuous current through the main terminals to 75% of the device rating. Other ways to ensure long life for a power discrete semiconductor are proper heat sinking and selection of voltage ratings for worst case conditions. Overheating, overvoltage (including dv/dt), and surge currents are the main killers of semiconductors. Correct mounting, soldering, and forming of the leads also help protect against component damage.

Reliability/Environmental Tests

| Test | Specifications and Conditions |
|----------------------------------|---|
| AC Blocking | MIL-STD-750, M-1040, Cond A Applied Peak AC voltage @ 110°C for 1008 hours |
| Temperature Cycling | MIL-STD-750, M-1051, 100 cycles; -40°C to +150°C; 15-min dwell-time |
| Temperature/Humidity | EIA / JEDEC, JESD22-A101 1008 hours; 320V - DC: 85°C; 85% rel humidity |
| High Temp Storage | MIL-STD-750, M-1031, 1008 hours; 150°C |
| Low-Temp Storage | 1008 hours; -40°C |
| Thermal Shock | MIL-STD-750, M-1056 10 cycles; 0°C to 100°C; 5-min dwell-time at each temperature; 10 sec (max) transfer time between temperature |
| Autoclave | EIA / JEDEC, JESD22-A102 168 hours (121°C at 2 ATMs) and 100% R/H |
| Resistance to Solder Heat | MIL-STD-750 Method 2031 |
| Solderability | ANSI/J-STD-002, category 3, Test A |
| Lead Bend | MIL-STD-750, M-2036 Cond E |

Dimensions – TO-92



| Dimension | Inches | | Millimeters | |
|-----------|--------|-------|-------------|-------|
| | Min | Max | Min | Max |
| A | 0.175 | 0.205 | 4.450 | 5.200 |
| B | 0.170 | 0.210 | 4.320 | 5.330 |
| C | 0.500 | | 12.70 | |
| D | 0.135 | | 3.430 | |
| E | 0.125 | 0.165 | 3.180 | 4.190 |
| F | 0.080 | 0.105 | 2.040 | 2.660 |
| G | 0.016 | 0.021 | 0.407 | 0.533 |
| H | 0.045 | 0.055 | 1.150 | 1.390 |
| I | 0.095 | 0.105 | 2.420 | 2.660 |
| J | 0.015 | 0.020 | 0.380 | 0.500 |

Dimensions – SOT-223

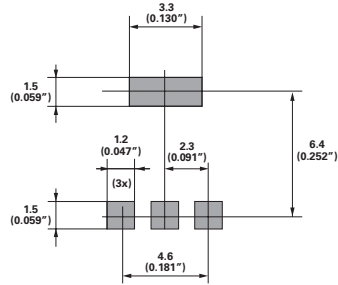
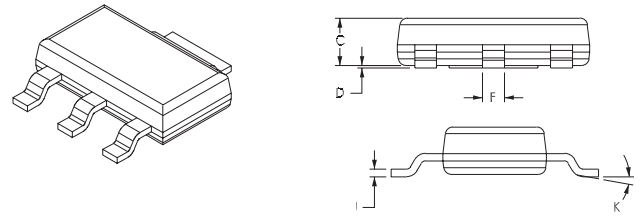

Dimensions in Millimeters (Inches)

| Dimensions | Inches | | | Millimeters | | |
|------------|---------|-------|-------|-------------|------|------|
| | Min | Typ | Max | Min | Typ | Max |
| A | 0.248 | 0.256 | 0.264 | 6.30 | 6.50 | 6.70 |
| B | 0.130 | 0.138 | 0.146 | 3.30 | 3.50 | 3.70 |
| C | — | — | 0.071 | — | — | 1.80 |
| D | 0.001 | — | 0.004 | 0.02 | — | 0.10 |
| E | 0.114 | 0.118 | 0.124 | 2.90 | 3.00 | 3.15 |
| F | 0.024 | 0.027 | 0.034 | 0.60 | 0.70 | 0.85 |
| G | — | 0.090 | — | — | 2.30 | — |
| H | — | 0.181 | — | — | 4.60 | — |
| I | 0.264 | 0.276 | 0.287 | 6.70 | 7.00 | 7.30 |
| J | 0.009 | 0.010 | 0.014 | 0.24 | 0.26 | 0.35 |
| K | 10° MAX | | | | | |

Dimensions – SOT-89

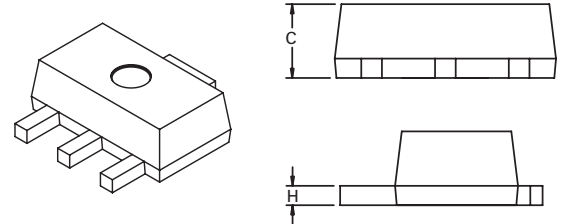

Pad Layout for SOT-89

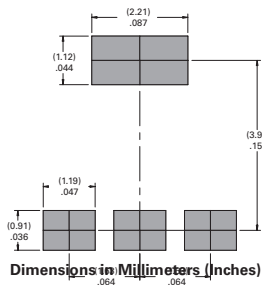

Dimensions in Millimeters (Inches)

| Dimension | Inches | | | Millimeters | | |
|-----------|--------|-----|-------|-------------|-----|------|
| | Min | Typ | Max | Min | Typ | Max |
| A | 0.173 | — | 0.181 | 4.40 | — | 4.60 |
| B | 0.090 | — | 0.102 | 2.29 | — | 2.60 |
| C | 0.055 | — | 0.063 | 1.40 | — | 1.60 |
| D | 0.155 | — | 0.167 | 3.94 | — | 4.25 |
| E | 0.035 | — | 0.047 | 0.89 | — | 1.20 |
| F | 0.056 | — | 0.062 | 1.42 | — | 1.57 |
| G | 0.115 | — | 0.121 | 2.92 | — | 3.07 |
| H | 0.014 | — | 0.017 | 0.35 | — | 0.44 |
| I | 0.014 | — | 0.019 | 0.36 | — | 0.48 |
| J | 0.064 | — | 0.072 | 1.62 | — | 1.83 |

Product Selector

| Part Number | Voltage | | | Gate Sensitivity | Package |
|-------------|---------|------|------|------------------|---------|
| | 400V | 600V | 800V | | |
| S4X8ES | X | — | — | 200 μ A | TO-92 |
| S6X8ES | — | X | — | 200 μ A | TO-92 |
| S8X8ES | — | — | X | 200 μ A | TO-92 |
| S4X8TS | X | — | — | 200 μ A | SOT-223 |
| S6X8TS | — | X | — | 200 μ A | SOT-223 |
| S8X8TS | — | — | X | 200 μ A | SOT-223 |
| S4X8BS | X | — | — | 200 μ A | SOT-89 |
| S6X8BS | — | X | — | 200 μ A | SOT-89 |
| S4X8ES1 | X | — | — | 5 μ A | TO-92 |
| S6X8ES1 | — | X | — | 5 μ A | TO-92 |
| S8X8ES1 | — | — | X | 5 μ A | TO-92 |
| S4X8TS1 | X | — | — | 5 μ A | SOT-223 |
| S6X8TS1 | — | X | — | 5 μ A | SOT-223 |
| S8X8TS1 | — | — | X | 5 μ A | SOT-223 |
| S4X8ES2 | X | — | — | 50 μ A | TO-92 |
| S6X8ES2 | — | X | — | 50 μ A | TO-92 |
| S8X8ES2 | — | — | X | 50 μ A | TO-92 |
| S4X8TS2 | X | — | — | 50 μ A | SOT-223 |
| S6X8TS2 | — | X | — | 50 μ A | SOT-223 |
| S8X8TS2 | — | — | X | 50 μ A | SOT-223 |

Packing Options

| Part Number | Marking | Weight | Packing Mode | Base Quantity |
|-------------|---------|--------|--------------|---------------|
| SxX8ESy | SxX8ESy | 0.170g | Bulk | 2500 |
| SxX8ESyAP | SxX8ESy | 0.170g | Ammo Pack | 2000 |
| SxX8ESyRP | SxX8ESy | 0.170g | Tape & Reel | 2000 |
| SxX8TSyRP | SxX8TSy | 0.120g | Tape & Reel | 1000 |
| SxX8BSRP | xX8 | 0.053g | Tape & Reel | 1000 |
| SxX8BSRP1 | xX8 | 0.053g | Tape & Reel | 1000 |

Note: x = voltage, y = gate sensitivity

TO-92 (3-lead) Reel Pack (RP) Radial Leaded Specifications

Meets all EIA-468-C Standards



TO-92 (3-lead) Ammo Pack (AP) Radial Leaded Specifications

Meets all EIA-468-C Standards



SOT-89 Reel Pack (RP) Specifications



SOT-89 Reel Pack (RP1) Specifications

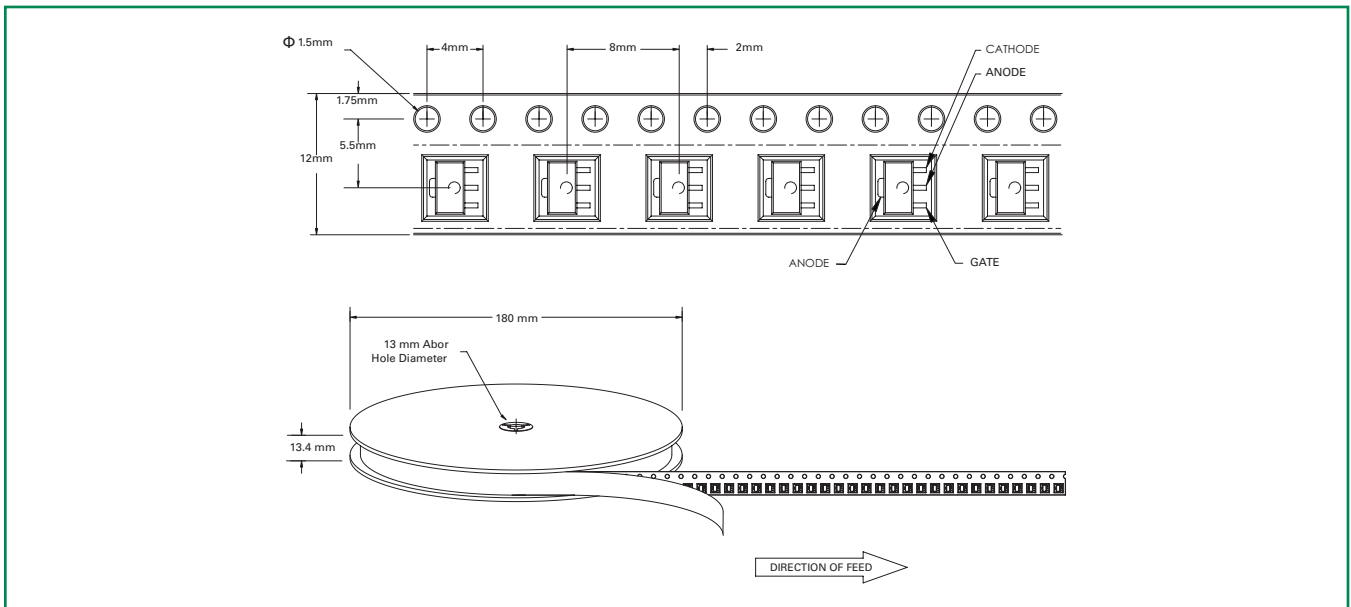

SOT-223 Reel Pack (RP) Specifications

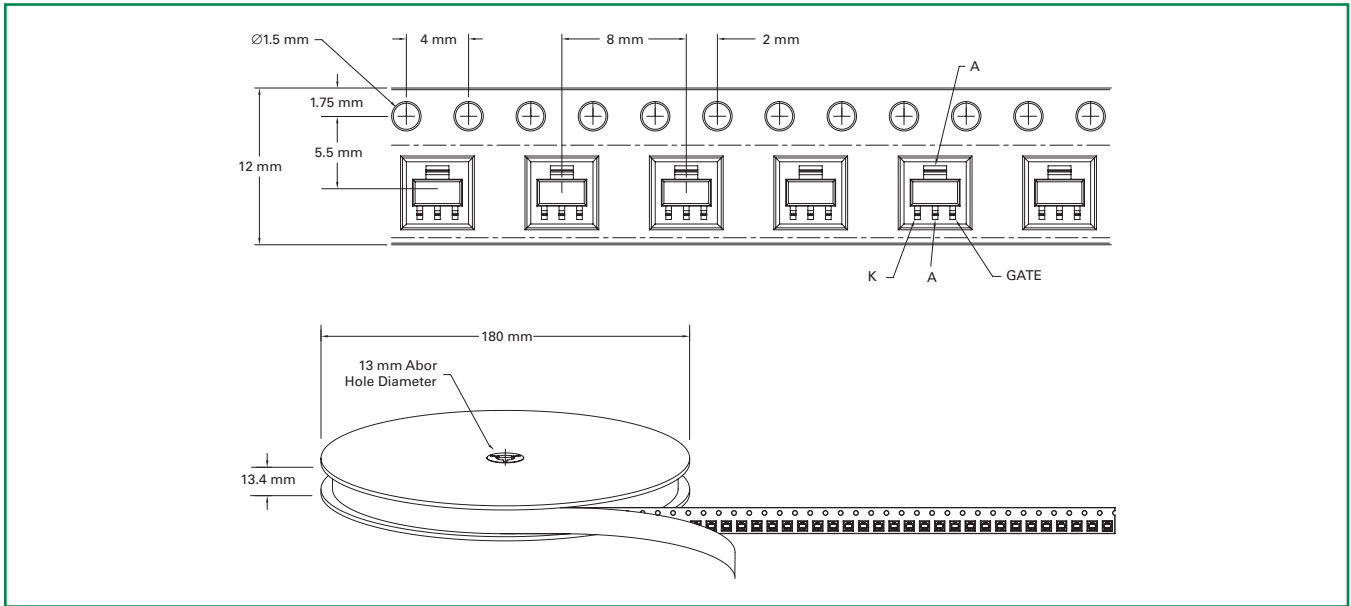

Part Numbering System

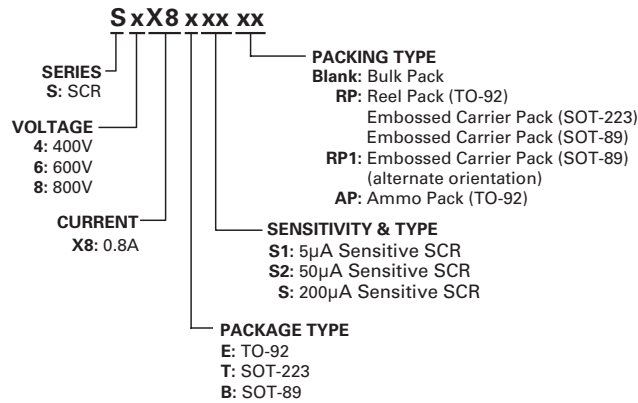

Part Marking System

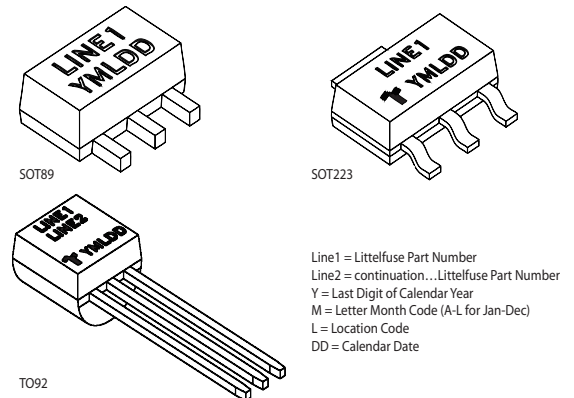



Стандарт Электрон Связь

Мы молодая и активно развивающаяся компания в области поставок электронных компонентов. Мы поставляем электронные компоненты отечественного и импортного производства напрямую от производителей и с крупнейших складов мира.

Благодаря сотрудничеству с мировыми поставщиками мы осуществляем комплексные и плановые поставки широчайшего спектра электронных компонентов.

Собственная эффективная логистика и склад в обеспечивает надежную поставку продукции в точно указанные сроки по всей России.

Мы осуществляем техническую поддержку нашим клиентам и предпродажную проверку качества продукции. На все поставляемые продукты мы предоставляем гарантию .

Осуществляем поставки продукции под контролем ВП МО РФ на предприятия военно-промышленного комплекса России , а также работаем в рамках 275 ФЗ с открытием отдельных счетов в уполномоченном банке. Система менеджмента качества компании соответствует требованиям ГОСТ ISO 9001.

Минимальные сроки поставки, гибкие цены, неограниченный ассортимент и индивидуальный подход к клиентам являются основой для выстраивания долгосрочного и эффективного сотрудничества с предприятиями радиоэлектронной промышленности, предприятиями ВПК и научно-исследовательскими институтами России.

С нами вы становитесь еще успешнее!

Наши контакты:

Телефон: +7 812 627 14 35

Электронная почта: sales@st-electron.ru

Адрес: 198099, Санкт-Петербург,
Промышленная ул, дом № 19, литера Н,
помещение 100-Н Офис 331