

# MAX712/MAX713

## NiCd/NiMH Battery Fast-Charge Controllers

### General Description

The MAX712/MAX713 fast-charge Nickel Metal Hydride (NiMH) and Nickel Cadmium (NiCd) batteries from a DC source at least 1.5V higher than the maximum battery voltage. 1 to 16 series cells can be charged at rates up to 4C. A voltage-slope detecting analog-to-digital converter, timer, and temperature window comparator determine charge completion. The MAX712/MAX713 are powered by the DC source via an on-board +5V shunt regulator. They draw a maximum of 5 $\mu$ A from the battery when not charging. A low-side current-sense resistor allows the battery charge current to be regulated while still supplying power to the battery's load.

The MAX712 terminates fast charge by detecting zero voltage slope, while the MAX713 uses a negative voltage-slope detection scheme. Both parts come in 16-pin DIP and SO packages. An external power PNP transistor, blocking diode, three resistors, and three capacitors are the only required external components.

The evaluation kit is available: Order the MAX712EVKIT-DIP for quick evaluation of the linear charger.

### Applications

Battery-Powered Equipment  
 Laptop, Notebook, and Palmtop Computers  
 Handy-Terminals  
 Cellular Phones

Portable Consumer Products  
 Portable Stereos  
 Cordless Phones

### Pin Configuration

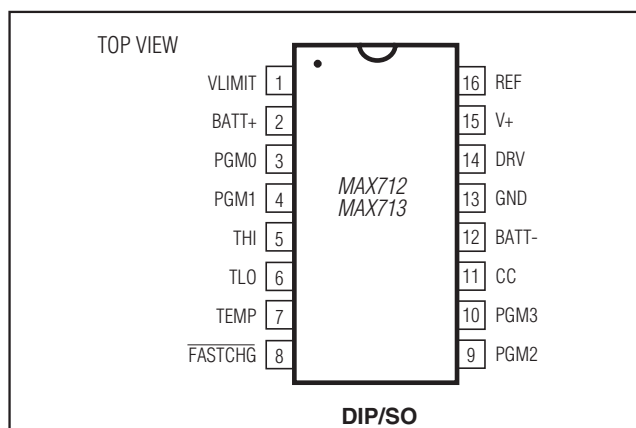

### Features

- ◆ Fast-Charge NiMH or NiCd Batteries
- ◆ Voltage Slope, Temperature, and Timer Fast-Charge Cutoff
- ◆ Charge 1 to 16 Series Cells
- ◆ Supply Battery's Load While Charging (Linear Mode)
- ◆ Fast Charge from C/4 to 4C Rate
- ◆ C/16 Trickle-Charge Rate
- ◆ Automatically Switch from Fast to Trickle Charge
- ◆ Linear Mode Power Control
- ◆ 5 $\mu$ A (max) Drain on Battery when Not Charging
- ◆ 5V Shunt Regulator Powers External Logic

### Ordering Information

| PART      | TEMP RANGE      | PIN-PACKAGE    |
|-----------|-----------------|----------------|
| MAX712CPE | 0°C to +70°C    | 16 Plastic DIP |
| MAX712CSE | 0°C to +70°C    | 16 Narrow SO   |
| MAX712C/D | 0°C to +70°C    | Dice*          |
| MAX712EPE | -40°C to +85°C  | 16 Plastic DIP |
| MAX712ESE | -40°C to +85°C  | 16 Narrow SO   |
| MAX712MJE | -55°C to +125°C | 16 CERDIP**    |

Ordering Information continued at end of data sheet.

\*Contact factory for dice specifications.

\*\*Contact factory for availability and processing to MIL-STD-883.

### Typical Operating Circuit

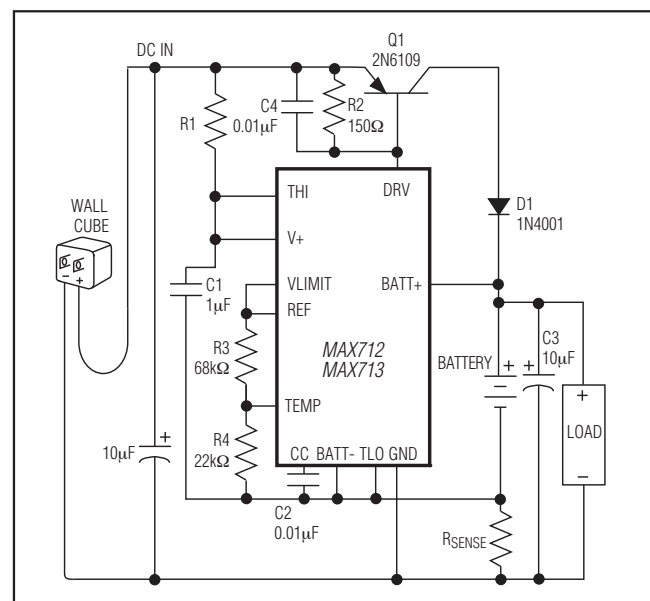

For pricing, delivery, and ordering information, please contact Maxim Direct at 1-888-629-4642, or visit Maxim's website at [www.maximintegrated.com](http://www.maximintegrated.com).

# MAX712/MAX713

## NiCd/NiMH Battery Fast-Charge Controllers

### ABSOLUTE MAXIMUM RATINGS

|  |   |   |                 |
|--|---|---|-----------------|
| V+ to BATT- .....                        | -0.3V, +7V  | REF Current.....                                      | 10mA            |
| BATT- to GND .....                       | ±1V   | Continuous Power Dissipation (T <sub>A</sub> = +70°C) |                 |
| BATT+ to BATT-<br>Power Not Applied..... | ±20V  | Plastic DIP (derate 10.53mW/°C above +70°C.....)      | 842mW           |
| With Power Applied .....                 | The higher of ±20V or<br>±2V x (programmed cells) | Narrow SO (derate 8.70mW/°C above +70°C .....         | 696mW           |
| DRV to GND .....                         | -0.3V, +20V                                       | CERDIP (derate 10.00mW/°C above +70°C .....           | 800mW           |
| FASTCHG to BATT-.....                    | -0.3V, +12V                                       | Operating Temperature Ranges                          |                 |
| All Other Pins to GND.....               | -0.3V, (V+ + 0.3V)                                | MAX71_C_E .....                                       | 0°C to +70°C    |
| V+ Current.....                          | 100mA   | MAX71_E_E .....                                       | -40°C to +85°C  |
| DRV Current.....                         | 100mA   | MAX71_MJE .....                                       | -55°C to +125°C |
|  |   | Storage Temperature Range .....                       | -65°C to +150°C |
|  |   | Lead Temperature (soldering, 10s) .....               | +300°C          |

Stresses beyond those listed under "Absolute Maximum Ratings" may cause permanent damage to the device. These are stress ratings only, and functional operation of the device at these or any other conditions beyond those indicated in the operational sections of the specifications is not implied. Exposure to absolute maximum rating conditions for extended periods may affect device reliability.

### ELECTRICAL CHARACTERISTICS

(I<sub>V+</sub> = 10mA, T<sub>A</sub> = T<sub>MIN</sub> to T<sub>MAX</sub>, unless otherwise noted. Refer to the *Typical Operating Circuit*. All measurements are with respect to BATT-, not GND.)

| PARAMETER   | CONDITIONS   | MIN  | TYP  | MAX  | UNITS                         |
|---|--|------|------|------|-------------------------------|
| V+ Voltage  | 5mA < I <sub>V+</sub> < 20mA   | 4.5  |      | 5.5  | V                             |
| I <sub>V+</sub> (Note 1)                            |  | 5    |      |      | mA                            |
| BATT+ Leakage                                       | V+ = 0V, BATT+ = 17V   |      |      | 5    | µA                            |
| BATT+ Resistance with Power On                      | PGM0 = PGM1 = BATT-, BATT+ = 30V   | 30   |      |      | kΩ                            |
| C1 Capacitance                                      |  | 0.5  |      |      | µF                            |
| C2 Capacitance                                      |  | 5    |      |      | nF                            |
| REF Voltage   | 0mA < I <sub>REF</sub> < 1mA   | 1.96 |      | 2.04 | V                             |
| Undervoltage Lockout                                | Per cell   | 0.35 |      | 0.50 | V                             |
| External VLIMIT Input Range                         |  | 1.25 |      | 2.50 | V                             |
| THI, TLO, TEMP Input Range                          |  | 0    |      | 2    | V                             |
| THI, TLO Offset Voltage (Note 2)                    | 0V < TEMP < 2V, TEMP voltage rising  | -10  |      | 10   | mV                            |
| THI, TLO, TEMP, VLIMIT Input Bias Current           |  | -1   |      | 1    | µA                            |
| VLIMIT Accuracy                                     | 1.2V < V <sub>LIMIT</sub> < 2.5V, 5mA < I <sub>DRV</sub> < 20mA,<br>PGM0 = PGM1 = V+ | -30  |      | 30   | mV                            |
| Internal Cell Voltage Limit                         | V <sub>LIMIT</sub> = V+  | 1.6  | 1.65 | 1.7  | V                             |
| Fast-Charge VSENSE                                  |  | 225  | 250  | 275  | mV                            |
| Trickle-Charge VSENSE                               | PGM3 = V+  | 1.5  | 3.9  | 7.0  | mV                            |
|   | PGM3 = open  | 4.5  | 7.8  | 12.0 |                               |
|   | PGM3 = REF   | 12.0 | 15.6 | 20.0 |                               |
|   | PGM3 = BATT-   | 26.0 | 31.3 | 38.0 |                               |
| Voltage-Slope Sensitivity (Note 3)                  | MAX713   |      | -2.5 |      | mV/t <sub>A</sub><br>per cell |
|   | MAX712   |      | 0    |      |                               |
| Timer Accuracy                                      |  | -15  |      | 15   | %                             |
| Battery-Voltage to Cell-Voltage<br>Divider Accuracy |  | -1.5 |      | 1.5  | %                             |
| DRV Sink Current                                    | V <sub>DRV</sub> = 10V   | 30   |      |      | mA                            |

# MAX712/MAX713

## NiCd/NiMH Battery Fast-Charge Controllers

### ELECTRICAL CHARACTERISTICS (continued)

( $I_{V+} = 10\text{mA}$ ,  $T_A = T_{\text{MIN}}$  to  $T_{\text{MAX}}$ , unless otherwise noted. Refer to the *Typical Operating Circuit*. All measurements are with respect to BATT-, not GND.)

| PARAMETER                | CONDITIONS  | MIN | TYP | MAX | UNITS         |
|--------------------------|---|-----|-----|-----|---------------|
| FASTCHG Low Current      | $V_{\text{FASTCHG}} = 0.4\text{V}$                | 2   |     |     | mA            |
| FASTCHG High Current     | $V_{\text{FASTCHG}} = 10\text{V}$                 |     |     | 10  | $\mu\text{A}$ |
| A/D Input Range (Note 4) | Battery voltage $\div$ number of cells programmed | 1.4 |     | 1.9 | V             |

**Note 1:** The MAX712/MAX713 are powered from the V+ pin. Since V+ shunt regulates to +5V, R1 must be small enough to allow at least 5mA of current into the V+ pin.

**Note 2:** Offset voltage of TH1 and TLO comparators referred to TEMP.

**Note 3:**  $t_A$  is the A/D sampling interval (Table 3).

**Note 4:** This specification can be violated when attempting to charge more or fewer cells than the number programmed. To ensure proper voltage-slope fast-charge termination, the (maximum battery voltage)  $\div$  (number of cells programmed) must fall within the A/D input range.

### Typical Operating Characteristics

( $T_A = +25^\circ\text{C}$ , unless otherwise noted.)

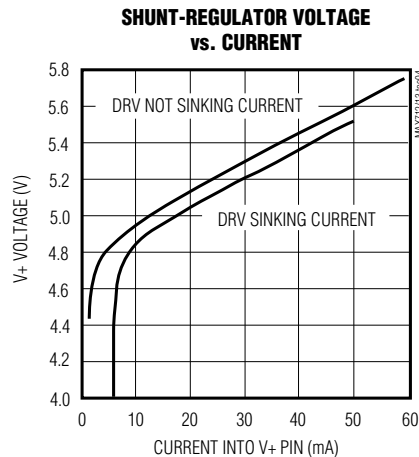
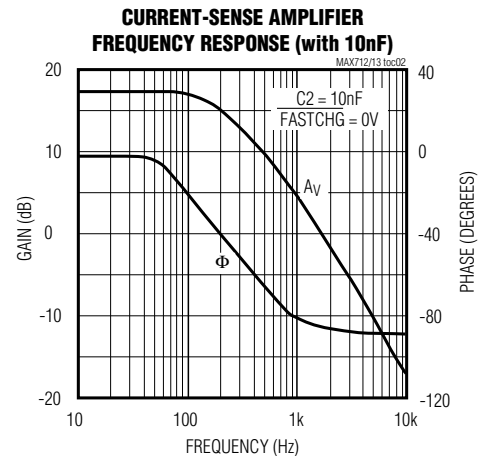
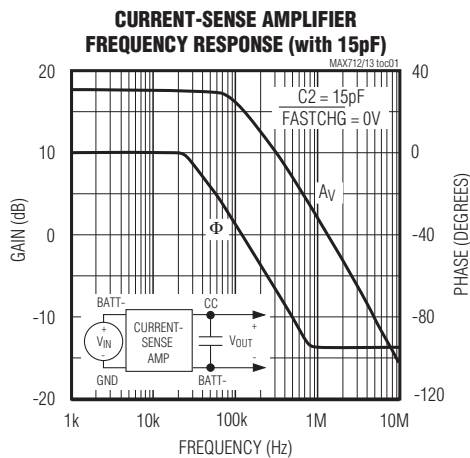

# MAX712/MAX713

## NiCd/NiMH Battery Fast-Charge Controllers

### Typical Operating Characteristics (continued)

( $T_A = +25^\circ\text{C}$ , unless otherwise noted.)

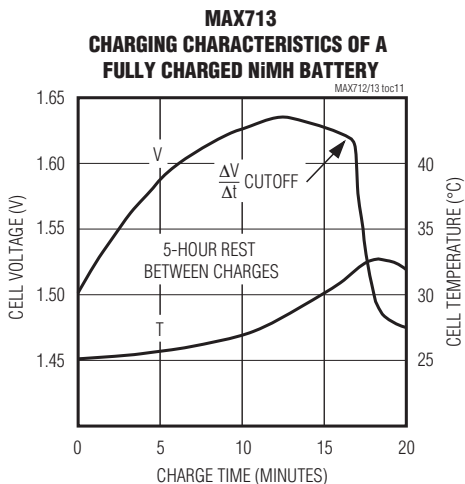
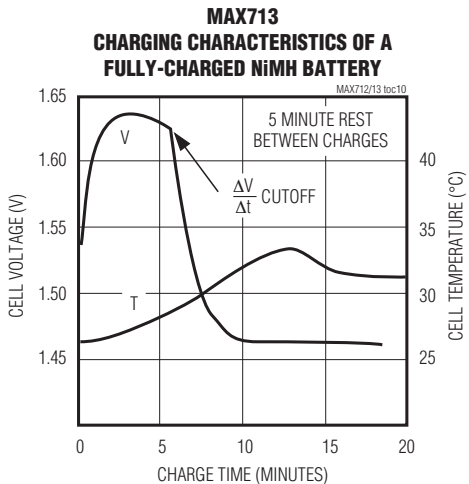
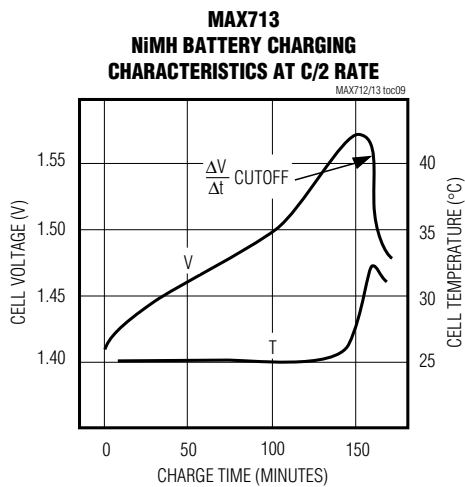
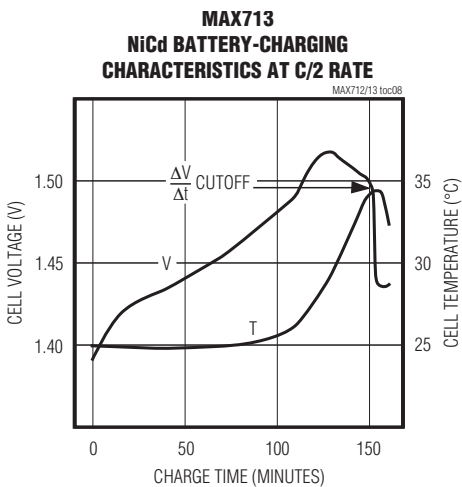
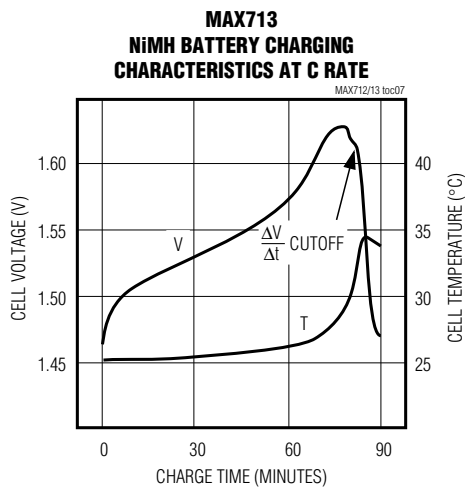
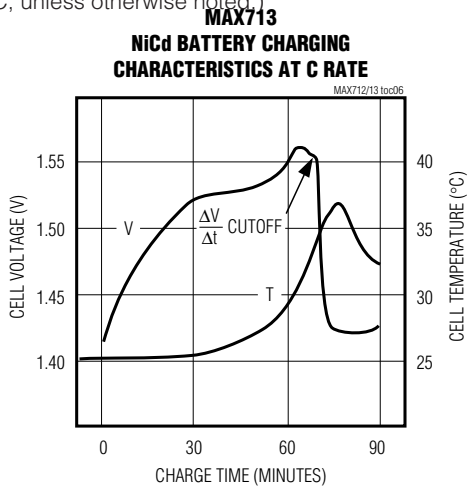

# MAX712/MAX713

## NiCd/NiMH Battery Fast-Charge Controllers

### Pin Description

| PIN   | NAME                        | FUNCTION   |
|-------|-----------------------------|--|
| 1     | VLIMIT                      | Sets the maximum cell voltage. The battery terminal voltage (BATT+ - BATT-) will not exceed VLIMIT x (number of cells). Do not allow VLIMIT to exceed 2.5V. Connect VLIMIT to VREF for normal operation. Alternatively, connect VLIMIT to V+ to set the maximum cell voltage to an internally preset 1.65V/cell.   |
| 2     | BATT+                       | Positive terminal of battery   |
| 3, 4  | PGM0,<br>PGM1               | PGM0 and PGM1 set the number of series cells to be charged. The number of cells can be set from 1 to 16 by connecting PGM0 and PGM1 to any of V+, REF, or BATT-, or by leaving the pin unconnected (Table 2). For cell counts greater than 11, see the <i>Linear-Mode, High Series Cell Count</i> section. Charging more or fewer cells than the number programmed may inhibit $\Delta V$ fast-charge termination. |
| 5     | THI                         | Trip point for the over-temperature comparator. If the voltage-on TEMP rises above THI, fast charge ends.  |
| 6     | TLO                         | Trip point for the under-temperature comparator. If the MAX712/MAX713 power on with the voltage-on TEMP less than TLO, fast charge is inhibited and will not start until TEMP rises above TLO.   |
| 7     | TEMP                        | Sense input for temperature-dependent voltage from thermistors.  |
| 8     | $\overline{\text{FASTCHG}}$ | Open-drain, fast-charge status output. While the MAX712/MAX713 fast charge the battery, $\overline{\text{FASTCHG}}$ sinks current. When charge ends and trickle charge begins, $\overline{\text{FASTCHG}}$ stops sinking current.  |
| 9, 10 | PGM2,<br>PGM3               | PGM2 and PGM3 set the maximum time allowed for fast charging. Timeouts from 33 minutes to 264 minutes can be set by connecting to any of V+, REF, or BATT-, or by leaving the pin unconnected (Table 3). PGM3 also sets the fast-charge to trickle-charge current ratio (Table 5).   |
| 11    | CC                          | Compensation input for constant current regulation loop  |
| 12    | BATT-                       | Negative terminal of battery   |
| 13    | GND                         | System ground. The resistor placed between BATT- and GND monitors the current into the battery.  |
| 14    | DRV                         | Current sink for driving the external PNP current source   |
| 15    | V+                          | Shunt regulator. The voltage on V+ is regulated to +5V with respect to BATT-, and the shunt current powers the MAX712/MAX713.  |
| 16    | REF                         | 2V reference output  |

# MAX712/MAX713

## NiCd/NiMH Battery Fast-Charge Controllers

### Getting Started

The MAX712/MAX713 are simple to use. A complete linear-mode fast-charge circuit can be designed in a few easy steps. A linear-mode design uses the fewest components and supplies a load while charging.

- 1) Follow the battery manufacturer's recommendations on maximum charge currents and charge-termination methods for the specific batteries in your application. Table 1 provides general guidelines.

**Table 1. Fast-Charge Termination Methods**

| Charge Rate | NiMH Batteries   | NiCd Batteries                                 |
|-------------|--|--|
| > 2C        | $\Delta V/\Delta t$ and temperature, MAX712 or MAX713    | $\Delta V/\Delta t$ and/or temperature, MAX713 |
| 2C to C/2   | $\Delta V/\Delta t$ and/or temperature, MAX712 or MAX713 | $\Delta V/\Delta t$ and/or temperature, MAX713 |
| < C/2       | $\Delta V/\Delta t$ and/or temperature, MAX712           | $\Delta V/\Delta t$ and/or temperature, MAX713 |

- 2) Decide on a charge rate (Tables 3 and 5). The slowest fast-charge rate for the MAX712/MAX713 is C/4, because the maximum fast-charge timeout period is 264 minutes. A C/3 rate charges the battery in about three hours. The current in mA required to charge at this rate is calculated as follows:

$$I_{FAST} = \frac{\text{capacity of battery in mAh}}{\text{charge time in hours}}$$

Depending on the battery, charging efficiency can be as low as 80%, so a C/3 fast charge could take 3 hours and 45 minutes. This reflects the efficiency with which electrical energy is converted to chemical energy within the battery, and is not the same as the power-conversion efficiency of the MAX712/MAX713.

- 3) Decide on the number of cells to be charged (Table 2). If your battery stack exceeds 11 cells, see the *Linear-Mode High Series Cell Count* section. Whenever changing the number of cells to be charged, PGM0 and PGM1 must be adjusted accordingly. Attempting

to charge more or fewer cells than the number programmed can disable the voltage-slope fast-charge termination circuitry. The internal ADC's input voltage range is limited to between 1.4V and 1.9V (see the *Electrical Characteristics*), and is equal to the voltage across the battery divided by the number of cells programmed (using PGM0 and PGM1, as in Table 2). When the ADC's input voltage falls out of its specified range, the voltage-slope termination circuitry can be disabled.

- 4) Choose an external DC power source (e.g., wall cube). Its minimum output voltage (including ripple) must be greater than 6V and at least 1.5V higher than the maximum battery voltage while charging. This specification is critical because normal fast-charge termination is ensured only if this requirement is maintained (see *Powering the MAX712/MAX713* section for more details).

- 5) For linear-mode designs, calculate the worst-case power dissipation of the power PNP and diode (Q1 and D1 in the *Typical Operating Circuit*) in watts, using the following formula:

$$P_{D_{PNP}} = (\text{maximum wall-cube voltage under load} - \text{minimum battery voltage}) \times (\text{charge current in amps})$$

- 6) Limit current into V+ to between 5mA and 20mA. For a fixed or narrow-range input voltage, choose R1 in the *Typical Operation Circuit* using the following formula:

$$R1 = (\text{minimum wall-cube voltage} - 5V)/5mA$$

- 7) Choose RSENSE using the following formula:

$$R_{SENSE} = 0.25V/(I_{FAST})$$

- 8) Consult Tables 2 and 3 to set pin-straps before applying power. For example, to fast charge at a rate of C/2, set the timeout to between 1.5x or 2x the charge period, three or four hours, respectively.

# MAX712/MAX713

## NiCd/NiMH Battery Fast-Charge Controllers

**Table 2. Programming the Number of Cells**

| NUMBER OF CELLS | PGM1 CONNECTION | PGM0 CONNECTION |
|-----------------|-----------------|-----------------|
| 1               | V+              | V+              |
| 2               | Open            | V+              |
| 3               | REF             | V+              |
| 4               | BATT-           | V+              |
| 5               | V+              | Open            |
| 6               | Open            | Open            |
| 7               | REF             | Open            |
| 8               | BATT-           | Open            |
| 9               | V+              | REF             |
| 10              | Open            | REF             |
| 11              | REF             | REF             |
| 12              | BATT-           | REF             |
| 13              | V+              | BATT-           |
| 14              | Open            | BATT-           |
| 15              | REF             | BATT-           |
| 16              | BATT-           | BATT-           |

**Table 3. Programming the Maximum Charge Time**

| TIMEOUT (min) | A/D SAMPLING INTERVAL (s) (tA) | VOLTAGE-SLOPE TERMINATION | PGM3 CONN | PGM2 CONN |
|---------------|--------------------------------|---------------------------|-----------|-----------|
| 22            | 21                             | Disabled                  | V+        | Open      |
| 22            | 21                             | Enabled                   | V+        | REF       |
| 33            | 21                             | Disabled                  | V+        | V+        |
| 33            | 21                             | Enabled                   | V+        | BATT-     |
| 45            | 42                             | Disabled                  | Open      | Open      |
| 45            | 42                             | Enabled                   | Open      | REF       |
| 66            | 42                             | Disabled                  | Open      | V+        |
| 66            | 42                             | Enabled                   | Open      | BATT-     |
| 90            | 84                             | Disabled                  | REF       | Open      |
| 90            | 84                             | Enabled                   | REF       | REF       |
| 132           | 84                             | Disabled                  | REF       | V+        |
| 132           | 84                             | Enabled                   | REF       | BATT-     |
| 180           | 168                            | Disabled                  | BATT-     | Open      |
| 180           | 168                            | Enabled                   | BATT-     | REF       |
| 264           | 168                            | Disabled                  | BATT-     | V+        |
| 264           | 168                            | Enabled                   | BATT-     | BATT-     |

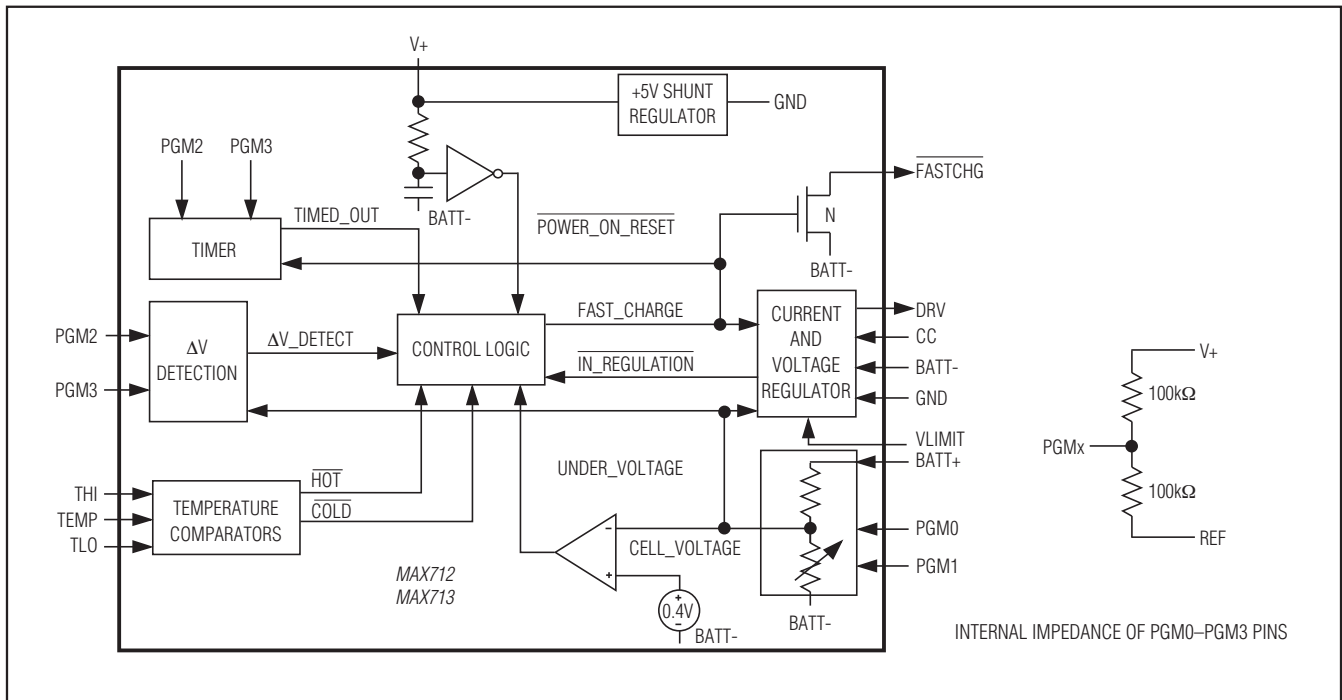

Figure 1. Block Diagram

# MAX712/MAX713

## NiCd/NiMH Battery Fast-Charge Controllers

### Detailed Description

The MAX712/MAX713 fast charge NiMH or NiCd batteries by forcing a constant current into the battery. The MAX712/MAX713 are always in one of two states: fast charge or trickle charge. During fast charge, the current level is high; once full charge is detected, the current reduces to trickle charge. The device monitors three variables to determine when the battery reaches full charge: voltage slope, battery temperature, and charge time.

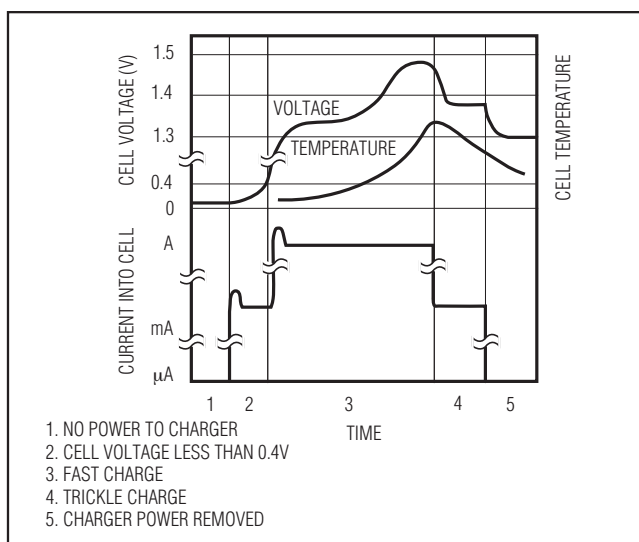

Figure 2. Typical Charging Using Voltage Slope

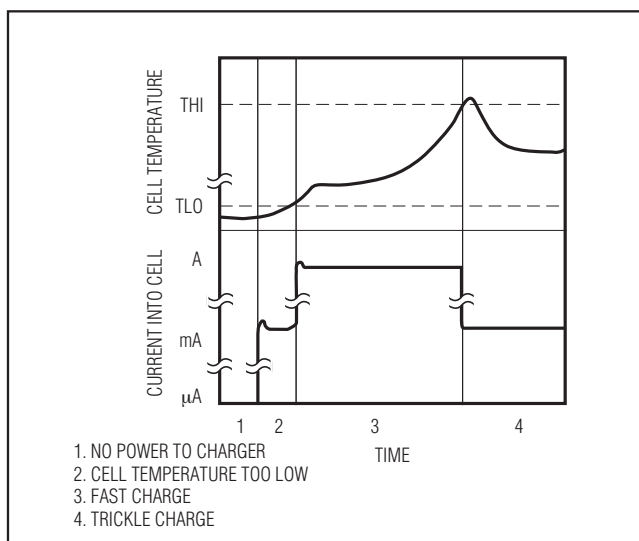

Figure 3. Typical Charging Using Temperature

Figure 1 shows the block diagram for the MAX712/MAX713. The timer, voltage-slope detection, and temperature comparators are used to determine full charge state. The voltage and current regulator controls output voltage and current, and senses battery presence.

Figure 2 shows a typical charging scenario with batteries already inserted before power is applied. At time 1, the MAX712/MAX713 draw negligible power from the battery. When power is applied to DC IN (time 2), the power-on reset circuit (see the `POWER_ON_RESET` signal in Figure 1) holds the MAX712/MAX713 in trickle charge. Once `POWER_ON_RESET` goes high, the device enters the fast-charge state (time 3) as long as the cell voltage is above the undervoltage lockout (UVLO) voltage (0.4V per cell). Fast charging cannot start until (battery voltage)/(number of cells) exceeds 0.4V.

When the cell voltage slope becomes negative, fast charge is terminated and the MAX712/MAX713 revert to trickle-charge state (time 4). When power is removed (time 5), the device draws negligible current from the battery.

Figure 3 shows a typical charging event using temperature full-charge detection. In the case shown, the battery pack is too cold for fast charging (for instance, brought in from a cold outside environment). During time 2, the MAX712/MAX713 remain in trickle-charge state. Once a safe temperature is reached (time 3), fast charge starts. When the battery temperature exceeds the limit set by `THI`, the MAX712/MAX713 revert to trickle charge (time 4).

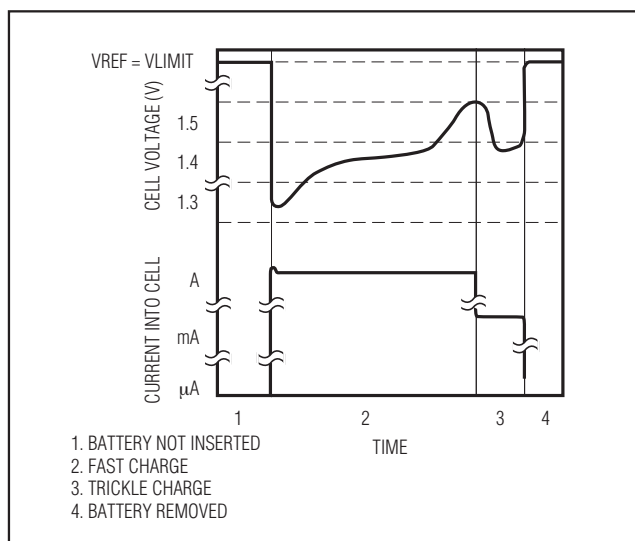

Figure 4. Typical Charging with Battery Insertion



# MAX712/MAX713

## NiCd/NiMH Battery Fast-Charge Controllers

The MAX712/MAX713 can be configured so that voltage slope and/or battery temperature detects full charge.

Figure 4 shows a charging event in which a battery is inserted into an already powered-up MAX712/MAX713. During time 1, the charger's output voltage is regulated at the number of cells times VLIMIT. Upon insertion of the battery (time 2), the MAX712/MAX713 detect current flow into the battery and switch to fast-charge state. Once full charge is detected, the device reverts to trickle charge (time 3). If the battery is removed (time 4), the MAX712/MAX713 remain in trickle charge and the output voltage is once again regulated as in time 1.

### Powering the MAX712/MAX713

AC-to-DC wall-cube adapters typically consist of a transformer, a full-wave bridge rectifier, and a capacitor. Figures 10–12 show the characteristics of three consumer product wall cubes. All three exhibit substantial 120Hz output voltage ripple. When choosing an adapter for use with the MAX712/MAX713, make sure the lowest wall-cube voltage level during fast charge and full load is at least 1.5V higher than the maximum battery voltage while being fast charged. Typically, the voltage on the

battery pack is higher during a fast-charge cycle than while in trickle charge or while supplying a load. The voltage across some battery packs may approach 1.9V/cell.

The 1.5V of overhead is needed to allow for worst-case voltage drops across the pass transistor (Q1 of *Typical*



Figure 5. DRV Pin Cascode Connection (for high DC IN voltage or to reduce MAX712/MAX713 power dissipation in linear mode)

Table 4. MAX712/MAX713 Charge-State Transition Table†

| POWER_ON_RESET | UNDER_VOLTAGE | IN_REGULATION | COLD | HOT | RESULT*                              |
|----------------|---------------|---------------|------|-----|--------------------------------------|
| 0              | x             | x             | x    | x   | Set trickle                          |
| ↑              | 1             | x             | x    | x   | No change                            |
| ↑              | x             | 1             | x    | x   | No change                            |
| ↑              | x             | x             | 0    | x   | No change                            |
| ↑              | x             | x             | x    | 0   | No change***                         |
| ↑              | 0             | 0             | 1    | 1   | Set fast                             |
| 1              | 0             | 0             | 1    | 1   | No change                            |
| 1              | 0             | 0             | ↓    | 1   | No change                            |
| 1              | ↓             | 0             | 1    | 1   | Set fast                             |
| 1              | 0             | ↓             | 1    | 1   | Set fast                             |
| 1              | 0             | 0             | 1    | ↑   | No change***                         |
| 1              | 0             | 0             | ↑    | 1   | Set fast**                           |
| 1              | x             | x             | 0    | x   | Trickle to fast transition inhibited |
| 1              | x             | x             | x    | 0   | Trickle to fast transition inhibited |
| 1              | ↑             | 0             | x    | x   | Set trickle                          |
| 1              | 0             | ↑             | x    | x   | Set trickle                          |
| 1              | x             | x             | x    | ↓   | Set trickle                          |

† Only two states exist: fast charge and trickle charge.

\* Regardless of the status of the other logic lines, a timeout or a voltage-slope detection will set trickle charge.

\*\* If the battery is cold at power-up, the first rising edge on COLD will trigger fast charge; however, a second rising edge will have no effect.

\*\*\* Batteries that are too hot when inserted (or when circuit is powered up) will not enter fast charge until they cool and power is recycled.

# MAX712/MAX713

## NiCd/NiMH Battery Fast-Charge Controllers

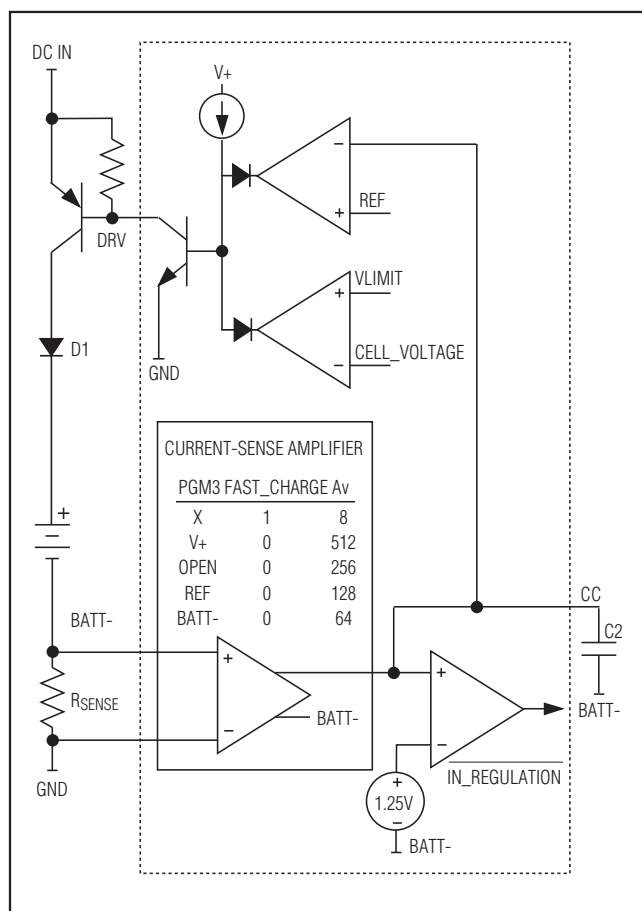

Figure 6. Current and Voltage Regulator (linear mode)

*Operating Circuit*), the diode (D1), and the sense resistor (RSENSE). This minimum input voltage requirement is critical, because violating it can inhibit proper termination of the fast-charge cycle. A safe rule of thumb is to choose a source that has a minimum input voltage = 1.5V + (1.9V x the maximum number of cells to be charged). When the input voltage at DC IN drops below the 1.5V + (1.9V x number of cells), the part oscillates between fast charge and trickle charge and might never completely terminate fast-charge.

The MAX712/MAX713 are inactive without the wall cube attached, drawing 5µA (max) from the battery. Diode D1 prevents current conduction into the DRV pin. When the wall cube is connected, it charges C1 through R1 (see *Typical Operating Circuit*) or the current-limiting diode (Figure 19). Once C1 charges to 5V, the internal shunt regulator sinks current to regulate V+ to 5V, and fast charge commences. The MAX712/MAX713 fast

charge until one of the three fast-charge terminating conditions is triggered.

If DC IN exceeds 20V, add a cascode connection in series with the DRV pin as shown in Figure 5 to prevent exceeding DRV's absolute maximum ratings.

Select the current-limiting component (R1 or D4) to pass at least 5mA at the minimum DC IN voltage (see step 6 in the *Getting Started* section). The maximum current into V+ determines power dissipation in the MAX712/MAX713.

$$\begin{aligned} \text{maximum current into V+} &= \\ &(\text{maximum DC IN voltage} - 5\text{V})/\text{R1} \\ \text{power dissipation due to shunt regulator} &= \\ &5\text{V} \times (\text{maximum current into V+}) \end{aligned}$$

Sink current into the DRV pin also causes power dissipation. Do not allow the total power dissipation to exceed the specifications shown in the *Absolute Maximum Ratings*.

### Fast Charge

The MAX712/MAX713 enter the fast-charge state under one of the following conditions:

- 1) Upon application of power (batteries already installed), with battery current detection (i.e., GND voltage is less than BATT- voltage), and TEMP higher than TLO and less than THI **and** cell voltage higher than the UVLO voltage.
- 2) Upon insertion of a battery, with TEMP higher than TLO and lower than THI **and** cell voltage higher than the UVLO voltage.

RSENSE sets the fast-charge current into the battery. In fast charge, the voltage difference between the BATT- and GND pins is regulated to 250mV. DRV current increases its sink current if this voltage difference falls below 250mV, and decreases its sink current if the voltage difference exceeds 250mV.

$$\text{fast-charge current (IFAST)} = 0.25\text{V}/\text{RSENSE}$$

### Trickle Charge

Selecting a fast-charge current (IFAST) of C/2, C, 2C, or 4C ensures a C/16 trickle-charge current. Other fast-charge rates can be used, but the trickle-charge current will not be exactly C/16.

The MAX712/MAX713 internally set the trickle-charge current by increasing the current amplifier gain (Figure 6), which adjusts the voltage across RSENSE (see Trickle-Charge VSENSE in the *Electrical Characteristics table*).

# MAX712/MAX713

## NiCd/NiMH Battery Fast-Charge Controllers

**Table 5. Trickle-Charge Current Determination from PGM3**

| PGM3  | FAST-CHARGE RATE | TRICKLE-CHARGE CURRENT (I <sub>TRICKLE</sub> ) |
|-------|------------------|--|
| V+    | 4C               | I <sub>FAST</sub> /64                          |
| OPEN  | 2C               | I <sub>FAST</sub> /32                          |
| REF   | C                | I <sub>FAST</sub> /16                          |
| BATT- | C/2              | I <sub>FAST</sub> /8                           |

### Nonstandard Trickle-Charge Current Example

Configuration:

Typical Operating Circuit  
 2 x Panasonic P-50AA 500mAh AA NiCd batteries  
 C/3 fast-charge rate  
 264-minute timeout  
 Negative voltage-slope cutoff enabled  
 Minimum DC IN voltage of 6V

Settings:

Use MAX713  
 PGM0 = V+, PGM1 = open, PGM2 = BATT-,  
 PGM3 = BATT-, R<sub>SENSE</sub> = 1.5Ω (fast-charge current,  
 I<sub>FAST</sub> = 167mA), R1 = (6V - 5V)/5mA = 200Ω

Since PGM3 = BATT-, the voltage on R<sub>SENSE</sub> is regulated to 31.3mV during trickle charge, and the current is 20.7mA. Thus the trickle current is actually C/25, not C/16.

### Further Reduction of Trickle-Charge Current for NiMH Batteries

The trickle-charge current can be reduced to less than C/16 using the circuit in Figure 7. In trickle charge, some of the current will be shunted around the battery, since Q2 is turned on. Select the value of R7 as follows:

$$R7 = (V_{BATT} + 0.4V) / (I_{TRICKLE} - I_{BATT})$$

where V<sub>BATT</sub> = battery voltage when charged  
 I<sub>TRICKLE</sub> = MAX712/MAX713 trickle-charge current setting

I<sub>BATT</sub> = desired battery trickle-charge current

### Regulation Loop

The regulation loop controls the output voltage between the BATT+ and BATT- terminals and the current through the battery via the voltage between BATT- and GND. The sink current from DRV is reduced when the



Figure 7. Reduction of Trickle Current for NiMH Batteries (Linear Mode)

output voltage exceeds the number of cells times V<sub>LIMIT</sub>, or when the battery current exceeds the programmed charging current.

For a linear-mode circuit, this loop provides the following functions:

- 1) When the charger is powered, the battery can be removed without interrupting power to the load.
- 2) If the load is connected as shown in the *Typical Operating Circuit*, the battery current is regulated regardless of the load current (provided the input power source can supply both).

### Voltage Loop

The voltage loop sets the maximum output voltage between BATT+ and BATT-. If V<sub>LIMIT</sub> is set to less than 2.5V, then:

Maximum BATT+ voltage (referred to BATT-) = V<sub>LIMIT</sub> × (number of cells as determined by PGM0, PGM1)

V<sub>LIMIT</sub> should be set between 1.9V and 2.5V. If V<sub>LIMIT</sub> is set below the maximum cell voltage, proper termination of the fast-charge cycle might not occur. Cell voltage can approach 1.9V/cell, under fast charge, in some battery packs. Tie V<sub>LIMIT</sub> to V<sub>REF</sub> for normal operation. Alternatively, connect V<sub>LIMIT</sub> to V+ to set the maximum cell voltage to an internally preset 1.6V/cell.

With the battery removed, the MAX712/MAX713 do not provide constant current; they regulate BATT+ to the maximum voltage as determined above.

# MAX712/MAX713

## NiCd/NiMH Battery Fast-Charge Controllers

The voltage loop is stabilized by the output filter capacitor. A large filter capacitor is required **only** if the load is going to be supplied by the MAX712/MAX713 in the absence of a battery. In this case, set  $C_{OUT}$  as:

$$C_{OUT} \text{ (in farads)} = (50 \times I_{LOAD}) / (V_{OUT} \times BW_{VRL})$$

where  $BW_{VRL}$  = loop bandwidth in Hz  
(10,000 recommended)

$$C_{OUT} > 10\mu\text{F}$$

$I_{LOAD}$  = external load current in amps

$V_{OUT}$  = programmed output voltage  
( $V_{LIMIT} \times \text{number of cells}$ )

### Current Loop

Figure 6 shows the current-regulation loop for a linear-mode circuit. To ensure loop stability, make sure that the bandwidth of the current regulation loop ( $BW_{CRL}$ ) is lower than the pole frequency of transistor Q1 ( $f_B$ ). Set  $BW_{CRL}$  by selecting C2.

$$BW_{CRL} \text{ in Hz} = gm / C2, \text{ C2 in farads, } gm = 0.0018 \text{ Siemens}$$

The pole frequency of the PNP pass transistor, Q1, can be determined by assuming a single-pole current gain response. Both  $f_T$  and  $B_0$  should be specified on the data sheet for the particular transistor used for Q1.

$$f_B \text{ in Hz} = f_T / B_0, f_T \text{ in Hz, } B_0 = \text{DC current gain}$$

Condition for Stability of Current-Regulation Loop:

$$BW_{CRL} < f_B$$

The MAX712/MAX713 dissipate power due to the current-voltage product at DRV. Do not allow the power dissipation to exceed the specifications shown in the *Absolute Maximum Ratings*. DRV power dissipation can be reduced by using the cascode connection shown in Figure 5.

$$\text{Power dissipation due to DRV sink current} = (\text{current into DRV}) \times (\text{voltage on DRV})$$

### Voltage-Slope Cutoff

The MAX712/MAX713's internal analog-to-digital converter has 2.5mV of resolution. It determines if the battery voltage is rising, falling, or unchanging by comparing the battery's voltage at two different times. After power-up, a time interval of  $t_A$  ranging from 21sec to 168sec passes (see Table 3 and Figure 8), then a battery voltage measurement is taken. It takes 5ms to perform a measurement. After the first measurement is complete, another  $t_A$  interval passes, and then a second measurement is taken. The two measurements are compared, and a decision whether to terminate charge is made. If charge is not terminated, another full two-measurement cycle is repeated until charge is

terminated. Note that each cycle has two  $t_A$  intervals and two voltage measurements.

The MAX712 terminates fast charge when a comparison shows that the battery voltage is unchanging. The MAX713 terminates when a conversion shows the battery voltage has fallen by at least 2.5mV per cell. This is the only difference between the MAX712 and MAX713.

### Temperature Charge Cutoff

Figure 9a shows how the MAX712/MAX713 detect over- and under-temperature battery conditions using negative temperature coefficient thermistors. Use the same model thermistor for T1 and T2 so that both have the same nominal resistance. The voltage at TEMP is 1V (referred to BATT-) when the battery is at ambient temperature.

The threshold chosen for THI sets the point at which fast charging terminates. As soon as the voltage-on TEMP rises above THI, fast charge ends, and does not restart after TEMP falls below THI.

The threshold chosen for TLO determines the temperature below which fast charging will be inhibited. If  $TLO > TEMP$  when the MAX712/MAX713 start up, fast charge will not start until TLO goes below TEMP.

The cold temperature charge inhibition can be disabled by removing R5, T3, and the 0.022μF capacitor; and by tying TLO to BATT-.

To disable the entire temperature comparator charge-cutoff mechanism, remove T1, T2, T3, R3, R4, and R5, and their associated capacitors, and connect THI to V+ and TLO to BATT-. Also, place a 68kΩ resistor from REF to TEMP, and a 22kΩ resistor from BATT- to TEMP.

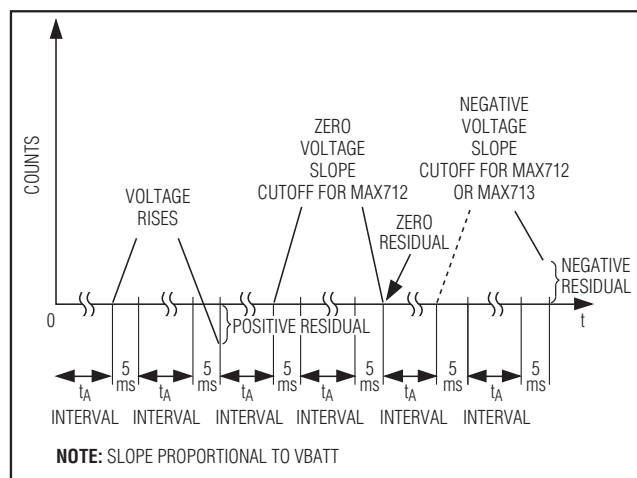

Figure 8. Voltage Slope Detection

# MAX712/MAX713

## NiCd/NiMH Battery Fast-Charge Controllers



Figure 9a. Temperature Comparators



Figure 9b. Alternative Temperature Comparator Configuration

Some battery packs come with a temperature-detecting thermistor connected to the battery pack's negative terminal. In this case, use the configuration shown in Figure 9b. Thermistors T2 and T3 can be replaced by standard resistors if absolute temperature charge cutoff is acceptable. All resistance values in Figures 9a and 9b should be chosen in the 10kΩ to 500kΩ range.

### Applications Information Battery-Charging Examples

Figures 13 and 14 show the results of charging 3 AA, 1000mAh, NiMH batteries from Gold Peak (part no. GP1000AAH, GP Batteries (619) 438-2202) at a 1A rate using the MAX712 and MAX713, respectively. The *Typical Operating Circuit* is used with Figure 9a's thermistor configuration.

DC IN = Sony AC-190 +9VDC at 800mA AC-DC adapter  
 PGM0 = V+, PGM1 = REF, PGM2 = REF, PGM3 = REF  
 R1 = 200Ω, R2 = 150Ω, RSENSE = 0.25Ω  
 C1 = 1µF, C2 = 0.01µF, C3 = 10µF, V<sub>LIMIT</sub> = REF  
 R3 = 10kΩ, R4 = 15kΩ  
 T1, T2 = part #14A1002 (Alpha Sensors: 858-549-4660) R5 omitted, T3 omitted, TLO = BATT-

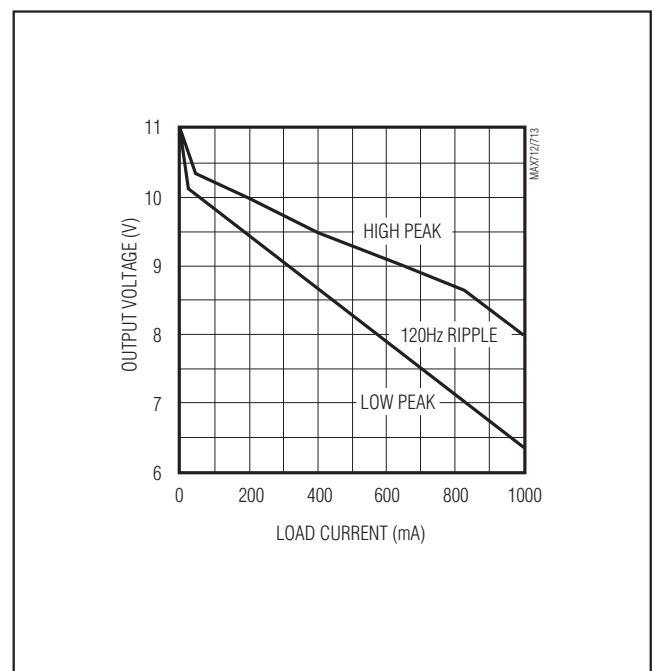

Figure 10. Sony Radio AC Adapter AC-190 Load Characteristic, 9VDC 800mA

# MAX712/MAX713

## NiCd/NiMH Battery Fast-Charge Controllers

### Linear-Mode, High Series Cell Count

The absolute maximum voltage rating for the BATT+ pin is higher when the MAX712/MAX713 are powered on. If more than 11 cells are used in the battery, the BATT+ input voltage must be limited by external circuitry when DC IN is not applied (Figure 15).

### Efficiency During Discharge

The current-sense resistor,  $R_{SENSE}$ , causes a small efficiency loss during battery use. The efficiency loss is significant only if  $R_{SENSE}$  is much greater than the

battery stack's internal resistance. The circuit in Figure 16 can be used to shunt the sense resistor whenever power is removed from the charger.

### Status Outputs

Figure 17 shows a circuit that can be used to indicate charger status with logic levels. Figure 18 shows a circuit that can be used to drive LEDs for power and charger status.



Figure 11. Sony CD Player AC Adapter AC-96N Load Characteristic, 9VDC 600mA

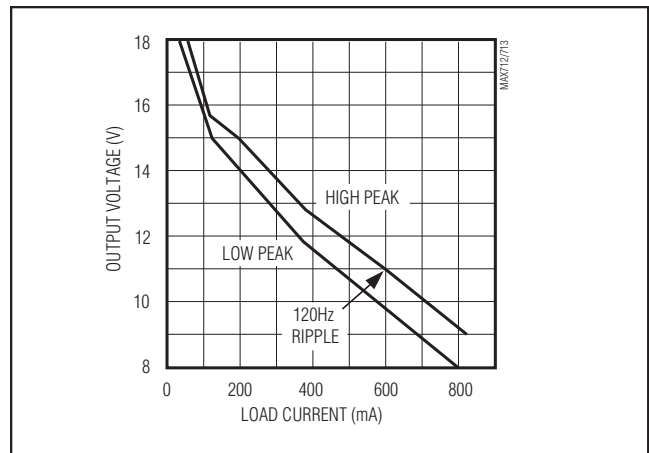

Figure 12. Panasonic Modem AC Adapter KX-A11 Load Characteristic, 12VDC 500mA



Figure 13. 3 NiMH Cells Charged with MAX712

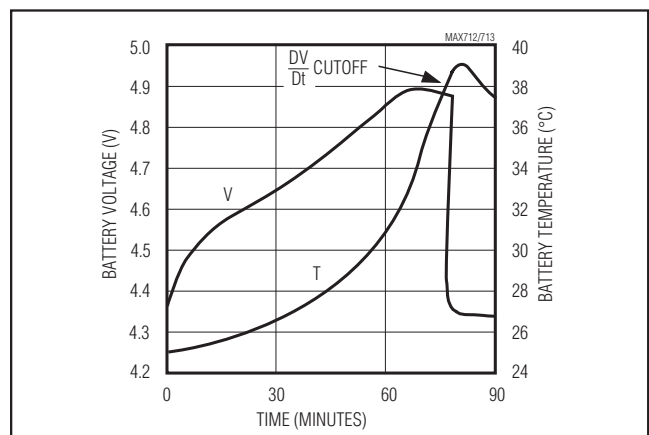

Figure 14. NiMH Cells Charged with MAX713

# MAX712/MAX713

## NiCd/NiMH Battery Fast-Charge Controllers



Figure 15. Cascading to Accommodate High Cell Counts for Linear-Mode Circuits



Figure 17. Logic-Level Status Outputs



Figure 16. Shunting  $R_{SENSE}$  for Efficiency Improvement



Figure 18. LED Connection for Status Outputs



# MAX712/MAX713

## NiCd/NiMH Battery Fast-Charge Controllers

### Ordering Information (continued)

| PART      | TEMP RANGE      | PIN-PACKAGE    |
|-----------|-----------------|----------------|
| MAX713CPE | 0°C to +70°C    | 16 Plastic DIP |
| MAX713CSE | 0°C to +70°C    | 16 Narrow SO   |
| MAX713C/D | 0°C to +70°C    | Dice*          |
| MAX713EPE | -40°C to +85°C  | 16 Plastic DIP |
| MAX713ESE | -40°C to +85°C  | 16 Narrow SO   |
| MAX713MJE | -55°C to +125°C | 16 CERDIP**    |

\*Contact factory for dice specifications.

\*\*Contact factory for availability and processing to MIL-STD-883.

### Package Information

For the latest package outline information and land patterns (footprints), go to [www.maximintegrated.com/packages](http://www.maximintegrated.com/packages). Note that a "+", "#", or "-" in the package code indicates RoHS status only. Package drawings may show a different suffix character, but the drawing pertains to the package regardless of RoHS status.

| PACKAGE TYPE   | PACKAGE CODE | DOCUMENT NO.            |
|----------------|--------------|-------------------------|
| 16 Plastic DIP | P16-1        | <a href="#">21-0043</a> |
| 16 Narrow SO   | S16-1        | <a href="#">21-0041</a> |
| 16 CERDIP      | J16-3        | <a href="#">21-0045</a> |

### Chip Topography

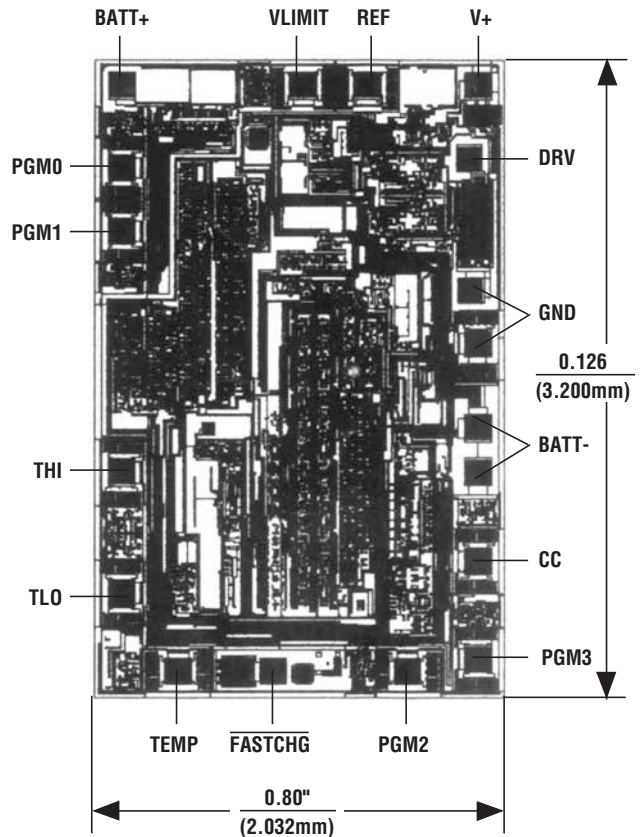

TRANSISTOR COUNT: 2193

SUBSTRATE CONNECTED TO V+



# MAX712/MAX713

## NiCd/NiMH Battery Fast-Charge Controllers

### Revision History

| REVISION NUMBER | REVISION DATE | DESCRIPTION   | PAGES CHANGED                      |
|-----------------|---------------|---|------------------------------------|
| 6               | 12/08         | Removed switch mode power control and added missing package information | 1, 5, 6, 9, 10, 12, 13, 14, 16, 17 |
| 7               | 7/13          | Updated information on the VLIMIT pin                                   | 5, 11                              |



Maxim Integrated cannot assume responsibility for use of any circuitry other than circuitry entirely embodied in a Maxim Integrated product. No circuit patent licenses are implied. Maxim Integrated reserves the right to change the circuitry and specifications without notice at any time. The parametric values (min and max limits) shown in the Electrical Characteristics table are guaranteed. Other parametric values quoted in this data sheet are provided for guidance.

**Maxim Integrated 160 Rio Robles, San Jose, CA 95134 USA 1-408-601-1000**

17



## Стандарт Электрон Связь

Мы молодая и активно развивающаяся компания в области поставок электронных компонентов. Мы поставляем электронные компоненты отечественного и импортного производства напрямую от производителей и с крупнейших складов мира.

Благодаря сотрудничеству с мировыми поставщиками мы осуществляем комплексные и плановые поставки широчайшего спектра электронных компонентов.

Собственная эффективная логистика и склад в обеспечивает надежную поставку продукции в точно указанные сроки по всей России.

Мы осуществляем техническую поддержку нашим клиентам и предпродажную проверку качества продукции. На все поставляемые продукты мы предоставляем гарантию .

Осуществляем поставки продукции под контролем ВП МО РФ на предприятия военно-промышленного комплекса России , а также работаем в рамках 275 ФЗ с открытием отдельных счетов в уполномоченном банке. Система менеджмента качества компании соответствует требованиям ГОСТ ISO 9001.

Минимальные сроки поставки, гибкие цены, неограниченный ассортимент и индивидуальный подход к клиентам являются основой для выстраивания долгосрочного и эффективного сотрудничества с предприятиями радиоэлектронной промышленности, предприятиями ВПК и научно-исследовательскими институтами России.

С нами вы становитесь еще успешнее!

### Наши контакты:

**Телефон:** +7 812 627 14 35

**Электронная почта:** [sales@st-electron.ru](mailto:sales@st-electron.ru)

**Адрес:** 198099, Санкт-Петербург,  
Промышленная ул, дом № 19, литера Н,  
помещение 100-Н Офис 331