

Description

The AP9211 is a single chip protection solution specially designed for 1-cell Li+ rechargeable battery pack application.

The AP9211 includes a 1-cell Lithium ion battery protection chip and dual N-CHANNEL MOSFET with common drain.

The AP9211 provides rich battery protection features and can turn-off the N-CHANNEL MOSFET by detecting overcharge voltage/current, over discharge voltage/current, or load short circuit. AP9211 has built-in fixed delay time to save external components.

The AP9211 is available in U-DFN2030-6 package.

Features

- High Voltage CMOS Process, up to 30V (VDD to VM)
- Low Quiescent Current (+25°C)
 - In Normal Mode, 3.0μA (Typ.), 4.5μA (Max.) $V_{DD} = 3.5V$
 - In Power-Down Mode, 0.1μA (Max.)
- High-Accuracy Voltage Detection Circuit (+25°C)
 - Overcharge Detection Voltage: 3.5V to 4.5V (5mV Steps) Accuracy $\pm 25mV$
 - Overcharge Hysteresis Voltage Range: 0.1V to 0.4V (50mV Steps) Accuracy $\pm 50mV$
 - Overdischarge Detection Voltage: 2.0V to 3.4V (10mV Steps) Accuracy $\pm 35mV$
 - Overdischarge Hysteresis Voltage Range: 0V to 0.7V (40mV Steps) Accuracy $\pm 65mV$
 - Discharge Overcurrent Detection Voltage: 0.05V to 0.32V (10mV Steps) Accuracy $\pm 15mV$
 - Short Current Detection Voltage: 0.45V to 0.7V (50mV Steps) Accuracy $\pm 100mV$
 - Charge Overcurrent Detection Voltage: -0.2V to -0.05V (10mV Steps) Accuracy $\pm 15mV$
 - Overcharger Detection Voltage: 8.0V (Fixed) Accuracy $\pm 2V$
 - Overcharger Release Voltage: 7.3V (Fixed) Accuracy $\pm 2V$
- Built-in Fixed Detection Delay Time (+25°C), Accuracy $\pm 20\%$
- Power-Down Mode Selectable (Yes or No)
- 0V Battery Charge Selectable (Permission or Inhibition)
- Overcharge Protection Mode Selectable (Auto Release or Latch)
- **Totally Lead-free & Fully RoHS Compliant (Notes 1 & 2)**
- **Halogen and Antimony Free. "Green" Device (Note 3)**

Notes: 1. No purposely added lead. Fully EU Directive 2002/95/EC (RoHS) & 2011/65/EU (RoHS 2) compliant.
 2. See http://www.diodes.com/quality/lead_free.html for more information about Diodes Incorporated's definitions of Halogen- and Antimony-free, "Green" and Lead-free.
 3. Halogen- and Antimony-free "Green" products are defined as those which contain <900ppm bromine, <900ppm chlorine (<1500ppm total Br + Cl) and <1000ppm antimony compounds.

Pin Assignments

(Top View)

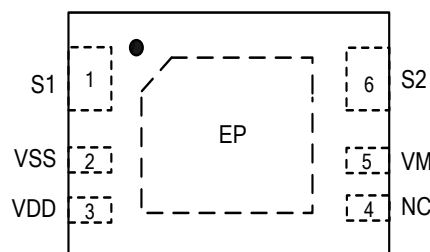

U-DFN2030-6

Applications

- Li+ Rechargeable Battery Pack

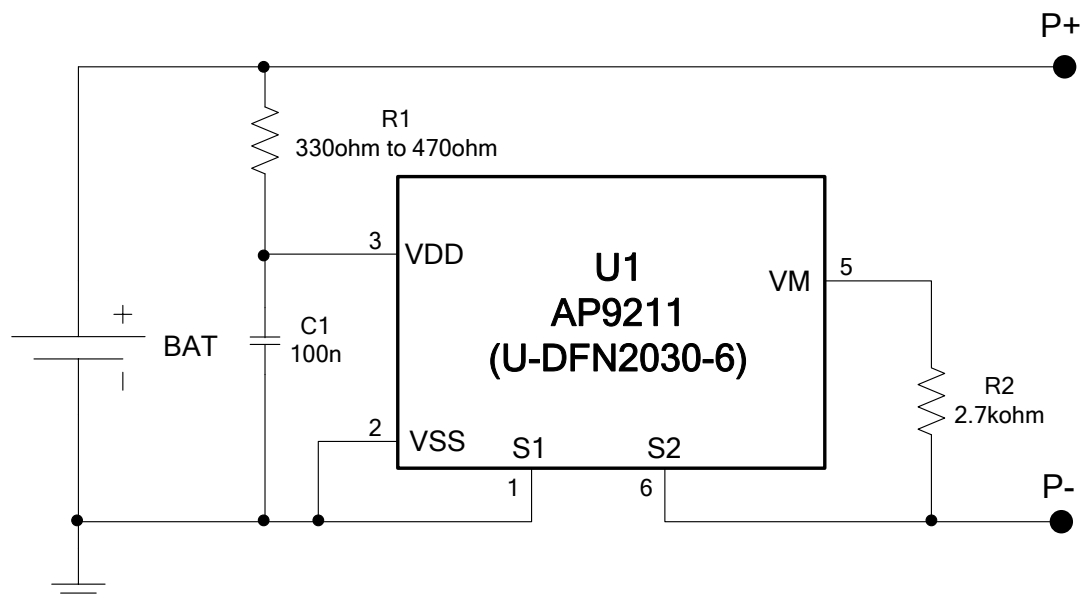
Typical Applications Circuit (Note 4)

Note: 4. R1 and C1 are used to stabilize the supply voltage of the AP9211. The recommended range of R1 value is 330Ω to 470Ω and C1 value is 10nF to 1000nF, typical value is 100nF. R2 should be connected between P- to V_M sense terminal to monitor the status of charger and the charge/discharge current. The R2 should be between 300Ω and 4kΩ, typical value is 2.7kΩ. R1 and R2 are also used as current limit resistors if the battery or charger is connected reversely. Polarity reversing may cause the power consumption of R1 and R2 to go over their power dissipation rating, therefore R1 and R2 values should be selected appropriately for the actual application. If R2 is more than 4kΩ resistor, charge may not be off due to the voltage drop on R2.

For power down mode, when first connecting AP9211 system board to the battery, it is necessary to use charger or to short P- to the battery negative polarity. Once the AP9211 is activated, the charger or connection can be removed, otherwise the battery cannot discharge current through system board.

The values selected should follow the recommended typical range mentioned above. It has not been confirmed whether the operation is normal or not in circuits other than the above example of connection. In addition, the example of connection shown above and the typical value do not exactly guarantee proper operation. Please perform the actual application to set the suitable value through your complete evaluation.

Pin Descriptions

Pin Number	Pin Name	Function
1	S1	Source pin of discharging MOSFET, connecting this pin to battery negative pole.
2	V_{SS}	Negative power supply pin
3	V_{DD}	Positive power supply pin, connecting this pin to battery positive pole through R1
4	NC	Not connected, leave this pin floating
5	V_M	Charger negative input pin, short this pin to S2 pin through R2
6	S2	Source pin of charging MOSFET, connecting this pin to charge negative input.
EP	D	Thermal PAD is common drain of charge and discharge MOSFET, so in PCB layout, prefer to use large copper area to cover this pad for better thermal dissipation, then leave it open.

Functional Block Diagram



Absolute Maximum Ratings (Notes 5 & 6)

Symbol	Parameter	Rating	Unit
V_{DS}	Supply Voltage (Between V_{DD} and V_{SS})	-0.3 to 12	V
V_{DM}	Charge Input Voltage (Between V_{DD} and V_M for Protection Chip)	-0.3 to 24	V
V_{DSS}	MOSFET Drain-to-Source Voltage	24	V
V_{GSS}	MOSFET Gate-to-Source Voltage	± 12	V
I_D	Continuous Drain Current, $V_{GS} = 4.5V$, $T_A = +25^\circ C$	9.0	A
	Continuous Drain Current, $V_{GS} = 4.5V$, $T_A = +70^\circ C$	7.1	A
P_D	Power Dissipation	1,000	mW
T_J	Maximum Junction Temperature	+150	$^\circ C$
T_{STG}	Storage Temperature Range	-65 to +150	$^\circ C$
—	ESD (Machine Model)	300	V
—	ESD (Human Body Model)	3,000	V

Notes: 5. Stresses beyond those listed under Absolute Maximum Ratings may cause permanent damage to the device. These are stress ratings only and functional operation of the device at these conditions is not implied. Exposure to absolute-maximum-rated conditions for extended periods may affect device reliability.

6. Ratings apply to ambient temperature at +25°C. The JEDEC High-K board design used to derive this data was a 2 inch x 2 inch multilayer board with 2-ounce internal power and ground planes and 2-ounce copper traces on the top and bottom of the board.

Recommended Operating Conditions

Symbol	Parameter	Min	Max	Unit
V_{DS}	Supply Voltage (Between V_{DD} and V_{SS})	1.5	5.5	V
V_{DM}	Charge Input Voltage (between V_{DD} and V_M)	-0.3	5.5	V
T_A	Operating Ambient Temperature	-40	+85	$^\circ C$

Electrical Characteristics ($T_A = +25^\circ\text{C}$, $V_{DD} = 3.5\text{V}$, $V_{SS} = 0\text{V}$, $R_1 = 220\Omega$, $R_2 = 1.0\text{k}\Omega$, $C_1 = 100\text{nF}$, unless otherwise specified)

Symbol	Parameter	Conditions	Min	Typ	Max	Units	
V_{CU}	Overcharge Detection Voltage	—	V_{CU} - 0.025	V_{CU}	V_{CU} + 0.025	V	
V_{CL}	Overcharge Release Voltage	$V_{CL} \neq V_{CU}$	V_{CL} - 0.050	V_{CL}	V_{CL} + 0.050	V	
		$V_{CL} = V_{CU}$	V_{CL} - 0.025	V_{CL}	V_{CL} + 0.025	V	
V_{DL}	Overdischarge Detection Voltage	—	V_{DL} - 0.035	V_{DL}	V_{DL} + 0.035	V	
V_{DU}	Overdischarge Release Voltage	$V_{DU} \neq V_{DL}$	V_{DU} - 0.100	V_{DU}	V_{DU} + 0.100	V	
		$V_{DU} = V_{DL}$	V_{DU} - 0.035	V_{DU}	V_{DU} + 0.035	V	
V_{DOC}	Discharge Overcurrent Detection Voltage	—	V_{DOC} -0.015	V_{DOC}	V_{DOC} +0.015	V	
V_{SHORT}	Load Short-Circuiting Detection Voltage	—	V_{SHORT} -0.10	V_{SHORT}	V_{SHORT} +0.10	V	
V_{COC}	Charge Overcurrent Detection Voltage	—	V_{COC} -0.015	V_{COC}	V_{COC} +0.015	V	
I_{CC}	Current Consumption During Operation	$V_{DD}=3.5\text{V}$ $V_M=0\text{V}$	1.5	3.0	4.5	μA	
I_{STB}	Current Consumption at Power Down	$V_{DD}=1.8\text{V}$ VM Pin Floating	Power Down Mode	—	—	0.1	μA
			Without Power Down Mode (Auto Wake up)	—	—	5.5	μA
R_{VMD}	Resistance Between V_M Pin and V_{DD} Pin	$V_{DD}=1.8\text{V}$ $V_M=0\text{V}$	150	300	500	$\text{k}\Omega$	
R_{VMS}	Resistance Between V_M Pin and V_{SS} Pin	$V_{DD}=3.5\text{V}$ $V_M=1.0\text{V}$	10	30	50	$\text{k}\Omega$	
V_{0CHA}	0V Battery Charge Starting Charge Voltage	0V battery charging "available"	1.2	—	—	V	
V_{0INH}	0V Battery Charge Inhibition Battery Voltage	0V battery charging "unavailable"	—	—	0.45	V	
V_{OVCHG}	Overvoltage Charge Detection Voltage	$V_{DD}=3.5\text{V}$	6.0	8.0	10.0	V	
V_{OVCHGR}	Overvoltage Charge Release Voltage	$V_{DD}=3.5\text{V}$	5.3	7.3	9.3	V	
t_{CU}	Overcharge Detection Delay Time	—	$t_{CU} * 0.8$	t_{CU}	$t_{CU} * 1.2$	ms	
t_{CUR}	Overcharge Release Delay Time	—	$t_{CUR} * 0.8$	t_{CUR}	$t_{CUR} * 1.2$	ms	
t_{DL}	Overdischarge Detection Delay Time	—	$t_{DL} * 0.8$	t_{DL}	$t_{DL} * 1.2$	ms	
t_{DLR}	Overdischarge Release Delay Time	—	$t_{DLR} * 0.8$	t_{DLR}	$t_{DLR} * 1.2$	ms	
t_{DOC}	Discharge Overcurrent Detection Delay Time	—	$t_{DOC} * 0.8$	t_{DOC}	$t_{DOC} * 1.2$	ms	
t_{DOCR}	Discharge Overcurrent Release Delay Time	—	$t_{DOCR} * 0.8$	t_{DOCR}	$t_{DOCR} * 1.2$	ms	
t_{SHORT}	Load Short Detection Delay Time	—	$t_{SHORT} * 0.8$	t_{SHORT}	$t_{SHORT} * 1.2$	μs	
t_{COC}	Charge Overcurrent Detection Delay Time	—	$t_{COC} * 0.8$	t_{COC}	$t_{COC} * 1.2$	ms	
t_{COCR}	Charge Overcurrent Release Delay Time	—	$t_{COCR} * 0.8$	t_{COCR}	$t_{COCR} * 1.2$	ms	

Electrical Characteristics (continued)

 $(T_A = -40^{\circ}\text{C to } +85^{\circ}\text{C}, V_{DD} = 3.5\text{V}, V_{SS} = 0\text{V}, R_1 = 220\Omega, R_2 = 1.0\text{k}\Omega, C_1 = 100\text{nF}, \text{ unless otherwise specified})$

Symbol	Parameter	Conditions	Min	Typ	Max	Units	
V_{CU}	Overcharge Detection Voltage	—	V_{CU} - 0.060	V_{CU}	V_{CU} + 0.040	V	
V_{CL}	Overcharge Release Voltage	$V_{CL} \neq V_{CU}$	V_{CL} - 0.080	V_{CL}	V_{CL} + 0.065	V	
		$V_{CL} = V_{CU}$	V_{CL} - 0.060	V_{CL}	V_{CL} + 0.040	V	
V_{DL}	Overdischarge Detection Voltage	—	V_{DL} - 0.080	V_{DL}	V_{DL} + 0.080	V	
V_{DU}	Overdischarge Release Voltage	$V_{DU} \neq V_{DL}$	V_{DU} - 0.150	V_{DU}	V_{DU} + 0.190	V	
		$V_{DU} = V_{DL}$	V_{DU} - 0.080	V_{DU}	V_{DU} + 0.080	V	
V_{DOC}	Discharge Overcurrent Detection Voltage	—	V_{DOC} -0.021	V_{DOC}	V_{DOC} +0.024	V	
V_{SHORT}	Load Short-Circuiting Detection Voltage	—	V_{SHORT} -0.34	V_{SHORT}	V_{SHORT} +0.34	V	
V_{COC}	Charge Overcurrent Detection Voltage	—	V_{COC} -0.040	V_{COC}	V_{COC} +0.040	V	
I_{CC}	Current Consumption During Operation	$V_{DD}=3.5\text{V}$ $V_M=0\text{V}$	1.0	3.0	7.0	μA	
I_{STB}	Current Consumption at Power Down	$V_{DD}=1.8\text{V}$ VM Pin Floating	Power Down Mode	—	—	1.0	μA
			Without Power Down Mode (Auto Wake up)	—	—	8	μA
R_{VMD}	Resistance between V_M Pin and V_{DD} Pin	$V_{DD}=1.8\text{V}$ $V_M=0\text{V}$	100	300	650	$\text{k}\Omega$	
R_{VMS}	Resistance between V_M Pin and V_{SS} Pin	$V_{DD}=3.5\text{V}$ $V_M=1.0\text{V}$	5	30	65	$\text{k}\Omega$	
V_{OCHA}	0V Battery Charge Starting Charge Voltage	0V battery charging "available"	1.2	—	—	V	
V_{OINH}	0V Battery Charge Inhibition Battery Voltage	0V battery charging "unavailable"	—	—	0.3	V	
V_{OVCHG}	Overvoltage Charge Detection Voltage	$V_{DD}=3.5\text{V}$	5.5	8.0	10.5	V	
V_{OVCHGR}	Overvoltage Charge Release Voltage	$V_{DD}=3.5\text{V}$	5.0	7.3	9.5	V	
t_{CU}	Overcharge Detection Delay Time	—	$t_{CU} * 0.6$	t_{CU}	$t_{CU} * 1.4$	ms	
t_{CUR}	Overcharge Release Delay Time	—	$t_{CUR} * 0.6$	t_{CUR}	$t_{CUR} * 1.4$	ms	
t_{DL}	Overdischarge Detection Delay Time	—	$t_{DL} * 0.6$	t_{DL}	$t_{DL} * 1.4$	ms	
t_{DLR}	Overdischarge Release Delay Time	—	$t_{DLR} * 0.6$	t_{DLR}	$t_{DLR} * 1.4$	ms	
t_{DOC}	Discharge Overcurrent Detection Delay Time	—	$t_{DOC} * 0.6$	t_{DOC}	$t_{DOC} * 1.4$	ms	
t_{DOCR}	Discharge Overcurrent Release Delay Time	—	$t_{DOCR} * 0.6$	t_{DOCR}	$t_{DOCR} * 1.4$	ms	
t_{SHORT}	Load Short Detection Delay Time	—	$t_{SHORT} * 0.6$	t_{SHORT}	$t_{SHORT} * 1.4$	μs	
t_{COC}	Charge Overcurrent Detection Delay Time	—	$t_{COC} * 0.6$	t_{COC}	$t_{COC} * 1.4$	ms	
t_{COCR}	Charge Overcurrent Release Delay Time	—	$t_{COCR} * 0.6$	t_{COCR}	$t_{COCR} * 1.4$	ms	

Electrical Characteristics (continued) (Notes 7 & 8)

($T_A = +25^\circ\text{C}$, $V_{DD} = 3.5\text{V}$, $V_{SS} = 0\text{V}$, $R1 = 220\Omega$, $R2 = 1.0\text{k}\Omega$, $C1 = 100\text{nF}$, unless otherwise specified)

Symbol	Parameter	Conditions	Min	Typ	Max	Units
I_{DSS}	Zero Gate Voltage Drain Current	$V_{DS} = 20\text{V}$, $V_{GS} = 0$	–	–	1.0	μA
$R_{SS(ON)1}$	Static Source-Source On-Resistance 1	$V_{DD} = 4.0\text{V}$ $I_D = 1.0\text{A}$	20	27	30	$\text{m}\Omega$
$R_{SS(ON)2}$	Static Source-Source On-Resistance 2	$V_{DD} = 3.9\text{V}$ $I_D = 1.0\text{A}$	21	27	31	$\text{m}\Omega$
$R_{SS(ON)3}$	Static Source-Source On-Resistance 3	$V_{DD} = 3.0\text{V}$ $I_D = 1.0\text{A}$	21	28	33	$\text{m}\Omega$
V_{SD}	Diode Forward Voltage	$V_{GS} = 0\text{V}$ (Note 6) $I_S = 1\text{A}$	–	0.75	1.0	V

Notes: 7. In case of Gate-Source voltage of charging MOSFET is 0V. In case of Gate-Source voltage of discharging MOSFET is 0V.
8. These specifications are guaranteed by design - will not be tested in production.

Application Information

Operation Mode

1. Normal Status

The AP9211 monitors the battery voltage between the V_{DD} pin and V_{SS} pin as well as the voltage difference between the V_M pin and V_{SS} pin to control battery charging and discharging. When the battery voltage is between overdischarge detection voltage (V_{DL}) and overcharge detection voltage (V_{CU}) as well as the V_M pin voltage is between the charge overcurrent detection voltage (V_{COC}) and discharge overcurrent detection voltage (V_{DOC}), the AP9211 will turn on discharging and charging MOSFET. In these conditions, the battery can charge and discharge freely. Also, R_{VMD} does not connect to V_{DD} pin and R_{VMS} does not connect to V_{SS} pin in this status.

2. Overcharge Status

If the battery voltage is more than V_{CU} during charging status for the overcharge detection delay time (t_{CU}) or longer, the AP9211 turns off the charging MOSFET to stop charging. R_{VMD} and R_{VMS} are not connected in overcharge status.

When V_M pin voltage is lower than V_{DOC} and battery voltage falls below V_{CL} , the AP9211 will release from overcharge status.

When V_M pin voltage is equal or more than V_{DOC} and battery voltage falls below V_{CU} , the AP9211 will release from overcharge status.

3. Overdischarge Status

If the battery voltage is less than V_{DL} during discharging status for the overdischarge detection delay time (t_{DL}) or longer, the AP9211 turns off the discharging MOSFET to stop discharging. In overdischarge status, R_{VMD} is connected to V_{DD} and V_M pin voltage is pulled up to V_{DD} by R_{VMD} , but R_{VMS} is not connected. For power-down mode version, the AP9211 recovers normal status from overdischarge status only by charging the battery through the charger.

When V_M pin voltage to V_{SS} pin voltage is less than typical -0.7V and the battery voltage rises over V_{DL} , the AP9211 will release from overdischarge status. If V_M pin voltage to V_{SS} pin voltage is higher than typical -0.7V, the AP9211 will release from overdischarge status until the battery voltage rises over V_{DU} .

For auto-wake-up version AP9211SA, the device recovers to normal status from overdischarge status if either of these two conditions are satisfied:

If charger is connected: the AP9211SA overdischarge status is released in the same way as described above in AP9211S Overdischarge Status section.

If no charger is connected: 1) The battery voltage reaches the overdischarge release voltage (V_{DU}) or higher;
2) Maintains continuous time more than overdischarge release delay time t_{DLR} .

4. Discharge Overcurrent and Short Current Status

When battery is in discharge overcurrent status, if the voltage of the V_M pin to V_{SS} pin is equal or more than V_{DOC} to V_{SHORT} and detection lasts for the discharge overcurrent detection delay time (t_{DOC}) or longer, the AP9211 turns off the discharging MOSFET to stop discharging.

When the battery is in short current status, if the voltage of the V_M pin to V_{SS} pin is equal to or more than V_{SHORT} , and the detection lasts for the short current detection delay time or longer, the AP9211 turns off the discharge MOSFET to stop discharging.

In discharge overcurrent or short current status, R_{VMS} is connected to V_{SS} but R_{VMD} is not connected. The voltage of V_M pin is almost equal to V_{DD} as long as the load is connected. When the load is disconnected, the voltage of V_M pin will become almost equal to V_{SS} (due to R_{VMS} being connected) and then the AP9211 will release from discharge overcurrent or short current status.

5. Charge Overcurrent Status

When the battery is in charge current status, if the voltage of the V_M pin to V_{SS} pin is equal to or less than V_{COC} and the detection continues for the charge overcurrent detection delay time (t_{COC}) or longer, the AP9211 turns off the charging MOSFET to stop charging.

6. 0V Battery Charging Function (Option)

This function is available as an option and can be factory set internally. AP9211 has this function built in.

0V charging function permits charger to recharge the battery whose voltage is 0V due to self-discharge. If 0V charging function is not present, the device will prevent charger to recharge the battery whose voltage is 0V due to self-discharge. (If a device without 0V charging function is needed, please contact Diodes sales team)

Operation Description (Continued)

7. Overvoltage Charger Detection Circuit

This function is used to monitor the charger voltage between the V_{DD} pin and V_M pin, and when this voltage exceeds overvoltage charger detection voltage (8.0V Typ.), the AP9211 will turn off charging MOSFET, when this voltage drops below overvoltage charger release voltage (7.3V Typ.), it then turns on charging MOSFET. There are no delay times set for detection and release.

8. Power-Down Mode or Auto-Wake-Up Function Option

In device with power-down function, during power-down mode, device enters the overdischarge status. The IC enters sleep mode and the current consumption becomes very low, typically 0.1 μ A. To release from power-down status to the normal status, charger connection is required.

In device with auto-wakeup mode, the IC remains active in the overdischarge state. The IC is released into the normal state by the operation that increases the battery voltage more than overdischarge release voltage.

Application Information (Timing Chart)

1. Overcharge and Overdischarge Detection

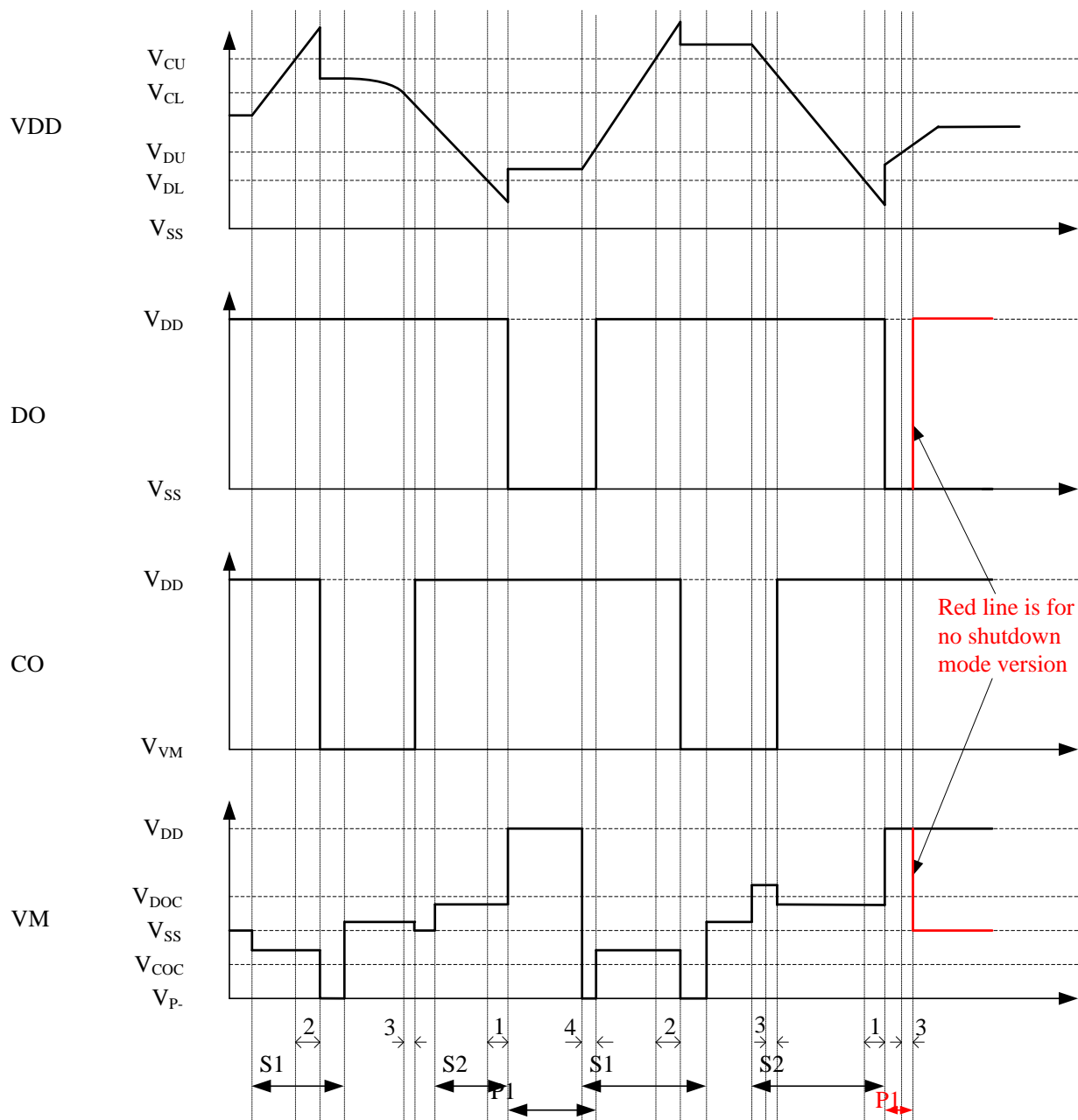

1: t_{DL}
2: t_{CU}
3: t_{CUR}
4: t_{DLR}

S1: Charger connection
S2: Load connection
P1: R_{VM} pull-up connection

Application Information (Timing Chart) (continued)

2. Discharge Overcurrent Detection

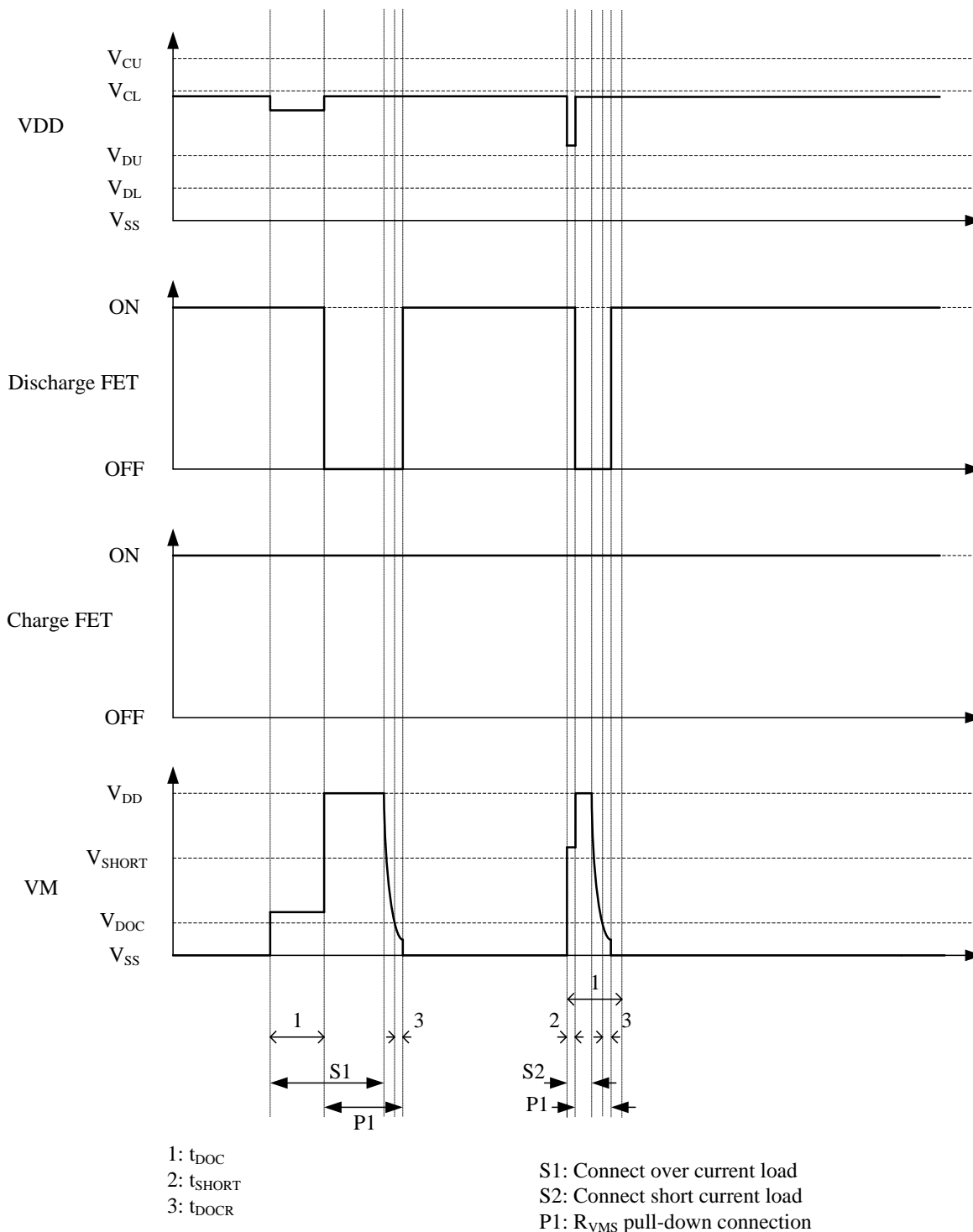

Application Information (Timing Chart) (cont.)

3. Charge Overcurrent Detection

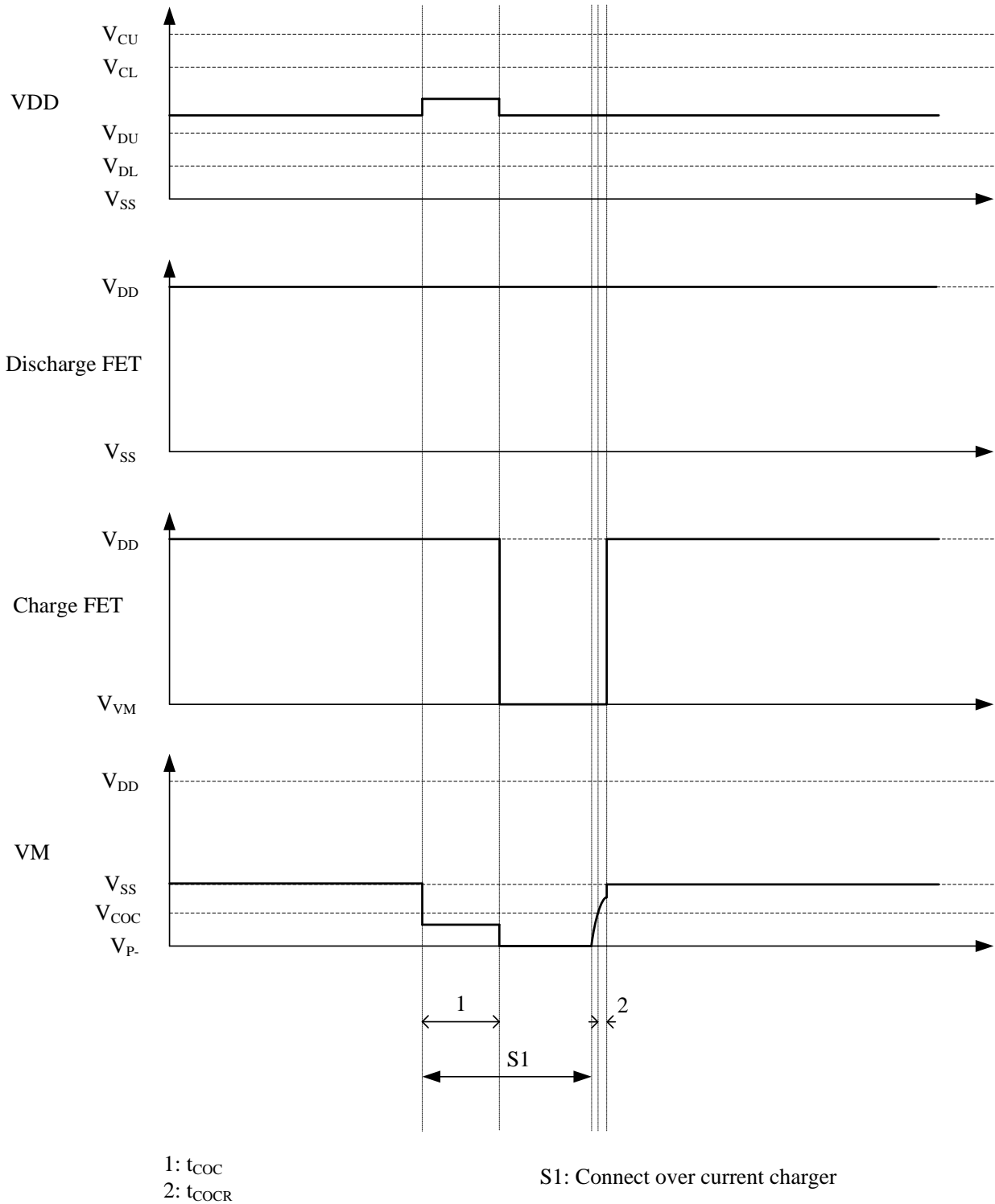

Ordering Information (Note 9)

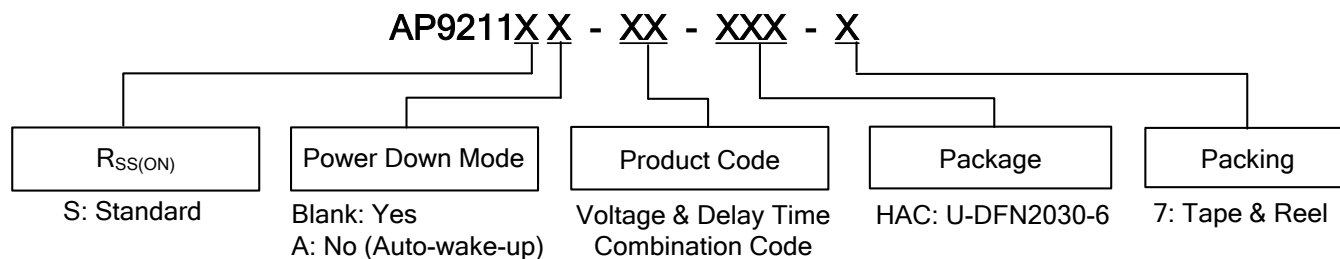

Part Number	Package Code	Packaging	7" Tape and Reel Quantity
AP9211XX-XX-HAC-7	HAC	U-DFN2030-6	3,000/Tape & Reel

Voltage Combination

Part Number	Overcharge Detection Voltage V _{CU}	Overcharge Release Voltage V _{CL}	Over-discharge Detection Voltage V _{DL}	Over-discharge Release Voltage V _{DU}	Discharge Overcurrent Detection Voltage V _{DOC}	Load Short Detection Voltage V _{SHORT}	Charge Overcurrent Detection Voltage V _{COC}	Over Voltage Charger Detection Voltage V _{OVCHG}	Over Voltage Charger Release Voltage V _{OVCHGR}	Power-down Function	Overcharge Protection Mode	Delay Time	0V Battery Charge Function
AP9211XX-AA-HAC-7	4.375V	4.175V	2.500V	2.900V	0.150V	0.700V	-0.150V	8.0V	7.3V	Selectable	Auto Release	Option 1	Permission
AP9211XX-AB-HAC-7	4.425V	4.225V	2.500V	2.900V	0.150V	0.700V	-0.150V	8.0V	7.3V	Selectable	Auto Release	Option 1	Permission
AP9211XX-AC-HAC-7	4.375V	4.175V	2.500V	2.900V	0.095V	0.700V	-0.095V	8.0V	7.3V	Selectable	Auto Release	Option 1	Permission
AP9211XX-AD-HAC-7	4.375V	4.175V	2.500V	2.900V	0.120V	0.700V	-0.120V	8.0V	7.3V	Selectable	Auto Release	Option 1	Permission
AP9211XX-AE-HAC-7	4.200V	4.100V	2.500V	3.000V	0.300V	0.550V	-0.100V	8.0V	7.3V	Selectable	Auto Release	Option 1	Permission
AP9211XX-AF-HAC-7	4.375V	4.175V	2.500V	2.900V	0.180V	0.700V	-0.180V	8.0V	7.3V	Selectable	Auto Release	Option 1	Permission
AP9211XX-AG-HAC-7	4.375V	4.175V	2.500V	2.900V	0.075V	0.700V	-0.075V	8.0V	7.3V	Selectable	Auto Release	Option 1	Permission
AP9211XX-AH-HAC-7	4.425V	4.225V	2.500V	2.900V	0.075V	0.700V	-0.075V	8.0V	7.3V	Selectable	Auto Release	Option 1	Permission
AP9211XX-AI-HAC-7	4.500V	4.300V	2.400V	2.800V	0.150V	0.700V	-0.075V	8.0V	7.3V	Selectable	Auto Release	Option 1	Permission
AP9211XX-AJ-HAC-7	4.375V	4.175 V	2.400V	2.800V	0.125V	0.700V	- 0.125V	8.0V	7.3V	Selectable	Auto Release	Option 1	Permission
AP9211XX-AK-HAC-7	4.250V	4.050 V	2.400V	3.000V	0.150V	0.700V	- 0.150V	8.0V	7.3V	Selectable	Auto Release	Option 1	Permission
AP9211XX-AL-HAC-7	4.275V	4.175V	2.300V	2.400V	0.180V	0.700V	-0.180V	8.0V	7.3V	Selectable	Auto Release	Option 1	Permission
AP9211XX-AM-HAC-7	4.375V	4.175V	2.300V	2.400V	0.180V	0.700V	-0.180V	8.0V	7.3V	Selectable	Auto Release	Option 1	Permission
AP9211XX-AN-HAC-7	4.225V	4.025V	3.200V	3.400V	0.060V	0.450V	-0.060V	8.0V	7.3V	Selectable	Auto Release	Option 1	Permission

Note: 9. Current voltage versions are built by delay time option 1. If any other voltage versions or delay time option products are needed, please contact with the local sale's office.

Ordering Information (Note 7, continued)

AP9211 Delay Time Combination

Part Number	Overcharge Detection Delay Time t _{CU}	Overcharge Release Delay Time t _{CUR}	Overdischarge Detection Delay Time t _{DL}	Overdischarge Release Delay Time t _{DLR}	Discharge Overcurrent Detection Delay Time t _{DOC}	Discharge Overcurrent Release Delay Time t _{DOCR}	Charge Overcurrent Detection Delay Time t _{COC}	Charge Overcurrent Release Delay Time t _{COCR}	Load Short Detection Delay Time t _{SHORT}
AP9211XX-XX-HAC-7	1.0s	2.0ms	115ms	2.0ms	10.0ms	2.0ms	10.0ms	2.0ms	360μs

Other Delay Time Combination Table (Optional)

Delay Time Option	Overcharge Detection Delay Time (t _{CU})	Overdischarge Detection Delay Time (t _{DL})	Discharge Over Current Detection Delay Time (t _{DOC})	Charge Over Current Detection Delay Time (t _{COC})	Load Short Circuiting Detection Delay Time (t _{SHORT})
1	1s	115ms	10ms	10ms	360μs
2	125ms	32ms	8ms	8ms	180μs
3	1s	20ms	12ms	10ms	360μs
4	1s	42ms	10ms	10ms	360μs
5	1s	115ms	10ms	10ms	180μs

Marking Information

(Top View)



XX : Identification Code
Y : Year : 0~9
W : Week : A~Z : 1~26 week;
 a~z : 27~52 week; z represents
 52 and 53 week
X : A~Z : Internal Code

Part Number	Package	Identification Code
AP9211S-AA-HAC-7	U-DFN2030-6	P5
AP9211S-AB-HAC-7	U-DFN2030-6	P6
AP9211S-AC-HAC-7	U-DFN2030-6	6B
AP9211S-AD-HAC-7	U-DFN2030-6	6C
AP9211S-AE-HAC-7	U-DFN2030-6	6D
AP9211S-AF-HAC-7	U-DFN2030-6	6E
AP9211S-AG-HAC-7	U-DFN2030-6	6F
AP9211S-AH-HAC-7	U-DFN2030-6	6G
AP9211S-AI-HAC-7	U-DFN2030-6	6H
AP9211S-AJ-HAC-7	U-DFN2030-6	6Y
AP9211S-AK-HAC-7	U-DFN2030-6	6Z
AP9211S-AL-HAC-7	U-DFN2030-6	5T
AP9211S-AM-HAC-7	U-DFN2030-6	5U
AP9211S-AN-HAC-7	U-DFN2030-6	5V
AP9211SA-AA-HAC-7	U-DFN2030-6	M3
AP9211SA-AB-HAC-7	U-DFN2030-6	M4
AP9211SA-AC-HAC-7	U-DFN2030-6	M6
AP9211SA-AD-HAC-7	U-DFN2030-6	M7
AP9211SA-AE-HAC-7	U-DFN2030-6	M8
AP9211SA-AF-HAC-7	U-DFN2030-6	N3
AP9211SA-AG-HAC-7	U-DFN2030-6	N4
AP9211SA-AH-HAC-7	U-DFN2030-6	N6
AP9211SA-AI-HAC-7	U-DFN2030-6	N7
AP9211SA-AJ-HAC-7	U-DFN2030-6	N8
AP9211SA-AK-HAC-7	U-DFN2030-6	NE
AP9211SA-AL-HAC-7	U-DFN2030-6	7X
AP9211SA-AM-HAC-7	U-DFN2030-6	P7
AP9211SA-AN-HAC-7	U-DFN2030-6	P8

Package Outline Dimensions

Please see AP02002 at <http://www.diodes.com/datasheets/ap02002.pdf> for the latest version.

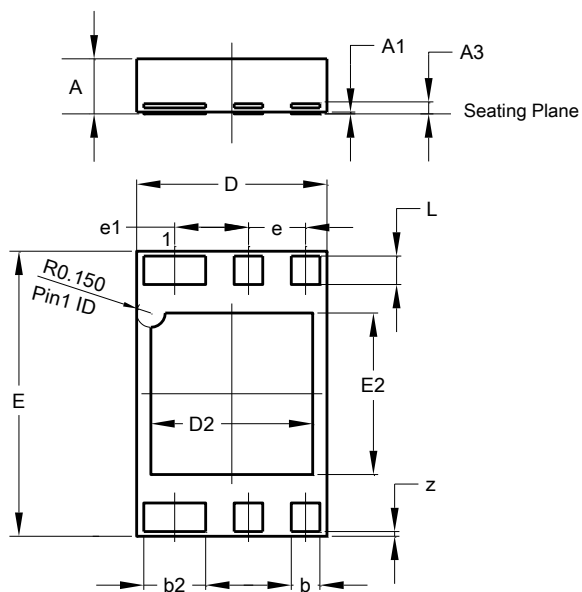

U-DFN2030-6 (Type C)			
Dim	Min	Max	Typ
A	0.50	0.60	--
A1	0.00	0.05	0.02
A3	--	--	0.127
b	0.25	0.35	0.30
b2	0.60	0.70	0.65
D	1.90	2.10	2.00
D2	1.60	1.80	1.70
E	2.90	3.10	3.00
E2	1.60	1.80	1.70
e	--	--	0.60
e1	--	--	0.775
L	0.25	0.35	0.30
z	0.0500 Ref		
All Dimensions in mm			

Suggested Pad Layout

Please see AP02001 at <http://www.diodes.com/datasheets/ap02001.pdf> for the latest version.

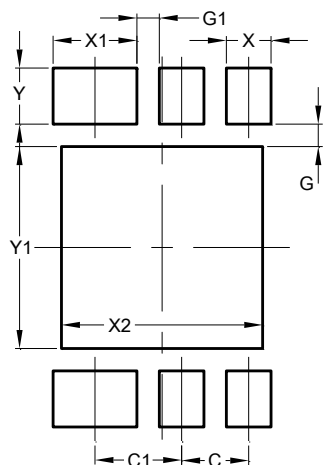

Dimensions	Value (in mm)
C	0.600
C1	0.775
G	0.200
G1	0.200
X	0.400
X1	0.750
X2	1.800
Y	0.500
Y1	1.800

IMPORTANT NOTICE

DIODES INCORPORATED MAKES NO WARRANTY OF ANY KIND, EXPRESS OR IMPLIED, WITH REGARDS TO THIS DOCUMENT, INCLUDING, BUT NOT LIMITED TO, THE IMPLIED WARRANTIES OF MERCHANTABILITY AND FITNESS FOR A PARTICULAR PURPOSE (AND THEIR EQUIVALENTS UNDER THE LAWS OF ANY JURISDICTION).

Diodes Incorporated and its subsidiaries reserve the right to make modifications, enhancements, improvements, corrections or other changes without further notice to this document and any product described herein. Diodes Incorporated does not assume any liability arising out of the application or use of this document or any product described herein; neither does Diodes Incorporated convey any license under its patent or trademark rights, nor the rights of others. Any Customer or user of this document or products described herein in such applications shall assume all risks of such use and will agree to hold Diodes Incorporated and all the companies whose products are represented on Diodes Incorporated website, harmless against all damages.

Diodes Incorporated does not warrant or accept any liability whatsoever in respect of any products purchased through unauthorized sales channel. Should Customers purchase or use Diodes Incorporated products for any unintended or unauthorized application, Customers shall indemnify and hold Diodes Incorporated and its representatives harmless against all claims, damages, expenses, and attorney fees arising out of, directly or indirectly, any claim of personal injury or death associated with such unintended or unauthorized application.

Products described herein may be covered by one or more United States, international or foreign patents pending. Product names and markings noted herein may also be covered by one or more United States, international or foreign trademarks.

This document is written in English but may be translated into multiple languages for reference. Only the English version of this document is the final and determinative format released by Diodes Incorporated.

LIFE SUPPORT

Diodes Incorporated products are specifically not authorized for use as critical components in life support devices or systems without the express written approval of the Chief Executive Officer of Diodes Incorporated. As used herein:

A. Life support devices or systems are devices or systems which:

1. are intended to implant into the body, or
2. support or sustain life and whose failure to perform when properly used in accordance with instructions for use provided in the labeling can be reasonably expected to result in significant injury to the user.

B. A critical component is any component in a life support device or system whose failure to perform can be reasonably expected to cause the failure of the life support device or to affect its safety or effectiveness.

Customers represent that they have all necessary expertise in the safety and regulatory ramifications of their life support devices or systems, and acknowledge and agree that they are solely responsible for all legal, regulatory and safety-related requirements concerning their products and any use of Diodes Incorporated products in such safety-critical, life support devices or systems, notwithstanding any devices- or systems-related information or support that may be provided by Diodes Incorporated. Further, Customers must fully indemnify Diodes Incorporated and its representatives against any damages arising out of the use of Diodes Incorporated products in such safety-critical, life support devices or systems.

Copyright © 2015, Diodes Incorporated

www.diodes.com



**Стандарт
Электрон
Связь**

Мы молодая и активно развивающаяся компания в области поставок электронных компонентов. Мы поставляем электронные компоненты отечественного и импортного производства напрямую от производителей и с крупнейших складов мира.

Благодаря сотрудничеству с мировыми поставщиками мы осуществляем комплексные и плановые поставки широчайшего спектра электронных компонентов.

Собственная эффективная логистика и склад в обеспечивает надежную поставку продукции в точно указанные сроки по всей России.

Мы осуществляем техническую поддержку нашим клиентам и предпродажную проверку качества продукции. На все поставляемые продукты мы предоставляем гарантию .

Осуществляем поставки продукции под контролем ВП МО РФ на предприятия военно-промышленного комплекса России , а также работаем в рамках 275 ФЗ с открытием отдельных счетов в уполномоченном банке. Система менеджмента качества компании соответствует требованиям ГОСТ ISO 9001.

Минимальные сроки поставки, гибкие цены, неограниченный ассортимент и индивидуальный подход к клиентам являются основой для выстраивания долгосрочного и эффективного сотрудничества с предприятиями радиоэлектронной промышленности, предприятиями ВПК и научно-исследовательскими институтами России.

С нами вы становитесь еще успешнее!

Наши контакты:

Телефон: +7 812 627 14 35

Электронная почта: sales@st-electron.ru

Адрес: 198099, Санкт-Петербург,
Промышленная ул, дом № 19, литера Н,
помещение 100-Н Офис 331