

PNP SURFACE MOUNT SMALL SIGNAL TRANSISTOR IN SOT323

Features

- Ideally Suited for Automatic Insertion
- Complementary NPN Types Available (BC846W – BC848W)
- For switching and AF Amplifier Applications
- **Totally Lead-Free & Fully RoHS compliant (Notes 1 & 2)**
- **Halogen and Antimony Free. "Green" Device (Note 3)**
- **Qualified to AEC-Q101 Standards for High Reliability**

Mechanical Data

- Case: SOT323
- Case material: molded plastic, "Green" molding compound
- UL Flammability Classification Rating 94V-0
- Moisture Sensitivity: Level 1 per J-STD-020
- Terminals: Finish – Matte Tin Plated Leads, Solderable per MIL-STD-202, Method 208 
- Weight: 0.006 grams (Approximate)



Top View

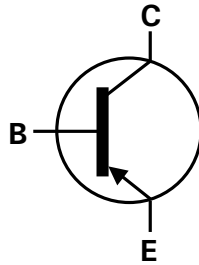

Device Symbol

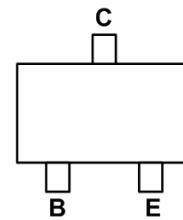

Top View
Pin-Out

Ordering Information (Note 4)

| Product | Marking | Reel size (inches) | Quantity per reel |
|--------------|---------|--------------------|-------------------|
| BC856AW-7-F | K3A | 7 | 3,000 |
| BC856BW-7-F | K3B | 7 | 3,000 |
| BC856BW-13-F | K3B | 13 | 10,000 |
| BC857AW-7-F | K3A | 7 | 3,000 |
| BC857BW-7-F | K3B | 7 | 3,000 |

| Product | Marking | Reel size (inches) | Quantity per reel |
|-------------|---------|--------------------|-------------------|
| BC857CW-7-F | K3G | 7 | 3,000 |
| BC858AW-7-F | K3A | 7 | 3,000 |
| BC858BW-7-F | K3B | 7 | 3,000 |
| BC858CW-7-F | K3G | 7 | 3,000 |

- Notes:
1. No purposely added lead. Fully EU Directive 2002/95/EC (RoHS) & 2011/65/EU (RoHS 2) compliant.
 2. See <http://www.diodes.com> for more information about Diodes Incorporated's definitions of Halogen and Antimony free, "Green" and Lead-Free.
 3. Halogen and Antimony free "Green" products are defined as those which contain <900ppm bromine, <900ppm chlorine (<1500ppm total Br + Cl) and <1000ppm antimony compounds.
 4. Tape width is 8mm. For more packaging details, go to our website at <http://www.diodes.com>.

Marking Information

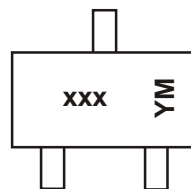

xxx = Product Type Marking Code
(Please see Ordering Information)
YM = Date Code Marking
Y = Year (ex: X = 2010)
M = Month (ex: 9 = September)

Date Code Key

| Year | 2010 | 2011 | 2012 | 2013 | 2014 | 2015 | 2016 | 2017 |
|------|------|------|------|------|------|------|------|------|
| Code | X | Y | Z | A | B | C | D | E |

| Month | Jan | Feb | Mar | Apr | May | Jun | Jul | Aug | Sep | Oct | Nov | Dec |
|-------|-----|-----|-----|-----|-----|-----|-----|-----|-----|-----|-----|-----|
| Code | 1 | 2 | 3 | 4 | 5 | 6 | 7 | 8 | 9 | O | N | D |

Maximum Ratings (@T_A = +25°C, unless otherwise specified.)

| Characteristic | Symbol | Value | Unit | |
|------------------------------|------------------|-------|------|---|
| Collector-Base Voltage | V _{CBO} | BC856 | -80 | V |
| | | BC857 | -50 | |
| | | BC858 | -30 | |
| Collector-Emitter Voltage | V _{CEO} | BC856 | -65 | V |
| | | BC857 | -45 | |
| | | BC858 | -30 | |
| Emitter-Base Voltage | V _{EBO} | -5.0 | V | |
| Continuous Collector Current | I _C | -100 | mA | |
| Peak Collector Current | I _{CM} | -200 | mA | |
| Peak Emitter Current | I _{EM} | -200 | mA | |

Thermal Characteristics (@T_A = +25°C, unless otherwise specified.)

| Characteristic | Symbol | Value | Unit |
|---|-----------------------------------|-------------|------|
| Power Dissipation | P _D | 200 | mW |
| Thermal Resistance, Junction to Ambient | R _{θJA} | 625 | °C/W |
| Operating and Storage Temperature Range | T _J , T _{STG} | -65 to +150 | °C |

Electrical Characteristics (@T_A = +25°C, unless otherwise specified.)

| Characteristic | Symbol | Min | Typ | Max | Unit | Test Condition | |
|---|----------------------|-------|------|------|------|--|--|
| Collector-Base Breakdown Voltage | BV _{CBO} | BC856 | -80 | - | - | V | I _C = -100nA |
| | | BC857 | -50 | | | | |
| | | BC858 | -30 | | | | |
| Collector-Emitter Breakdown Voltage (Note 6) | BV _{CEO} | BC856 | -65 | - | - | V | I _C = -10mA |
| | | BC857 | -45 | | | | |
| | | BC858 | -30 | | | | |
| Emitter-Base Breakdown Voltage | BV _{EBO} | -5 | - | - | V | I _E = -100nA | |
| DC Current Gain (Note 6) | Current Gain Group | A | 125 | 180 | 250 | - | V _{CE} = -5.0V, I _C = -2.0mA |
| | | B | 220 | 290 | 475 | | |
| | | C | 420 | 520 | 800 | | |
| Collector Cutoff Current | I _{CBO} | - | - | -15 | nA | V _{CB} = -30V | |
| | | | | -4 | μA | | V _{CB} = -30V, T _A = +150°C |
| Collector-Emitter Saturation Voltage (Note 6) | V _{CE(sat)} | - | -75 | -300 | mV | I _C = -10mA, I _B = -0.5mA | |
| | | | -250 | -650 | | | I _C = -100mA, I _B = -5.0mA |
| Base-Emitter Turn-On Voltage (Note 6) | V _{BE(on)} | - | -600 | -650 | mV | I _C = -2mA, V _{CE} = -5V | |
| | | | - | - | | | I _C = -10mA, V _{CE} = -5V |
| Base-Emitter Saturation Voltage (Note 6) | V _{BE(sat)} | - | -700 | - | mV | I _C = -10mA, I _B = -0.5mA | |
| | | | -850 | -950 | | | I _C = -100mA, I _B = -5mA |
| Output Capacitance | C _{obo} | - | 3 | 4.5 | pF | V _{CB} = -10V, f = 1.0MHz | |
| Transition Frequency | f _T | 100 | 200 | - | MHz | V _{CE} = -5V, I _C = -10mA, f = 100MHz | |
| Noise Figure | NF | - | - | 10 | dB | V _{CE} = -5V, I _C = -200μA R _S = 2kΩ, f = 1kHz Δf = 200Hz | |

- Notes:
- For the device mounted on minimum recommended pad layout FR4 PCB with high coverage of single sided 1oz copper in still air condition; the device is measured when operating in a steady-state condition.
 - Measured under pulsed conditions. Pulse width ≤ 300μs. Duty cycle ≤ 2%

Typical Electrical Characteristics (@ $T_A = +25^\circ\text{C}$, unless otherwise specified.)

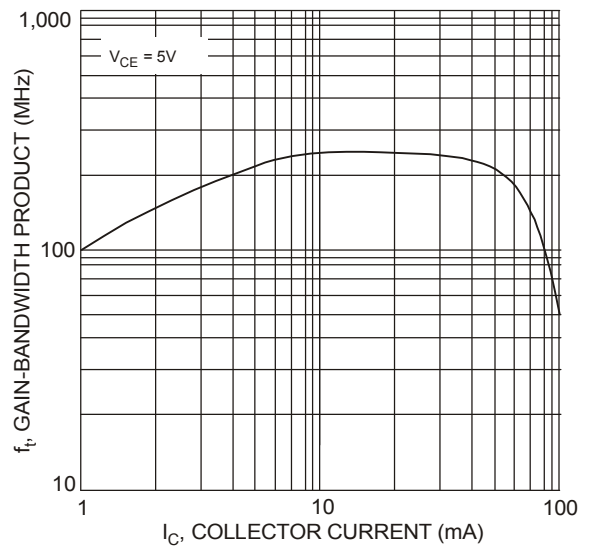
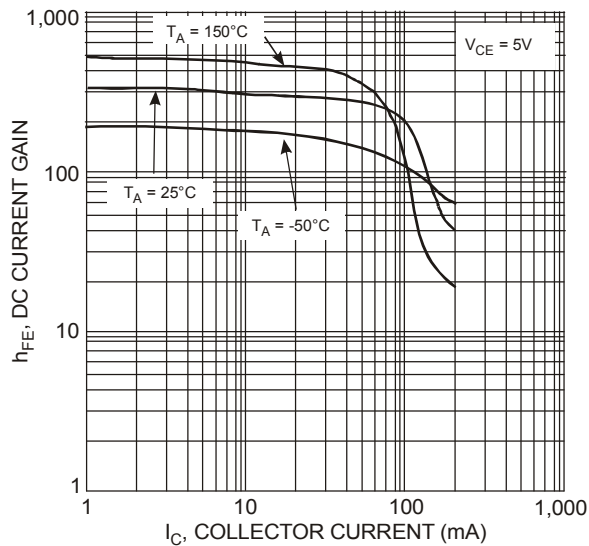
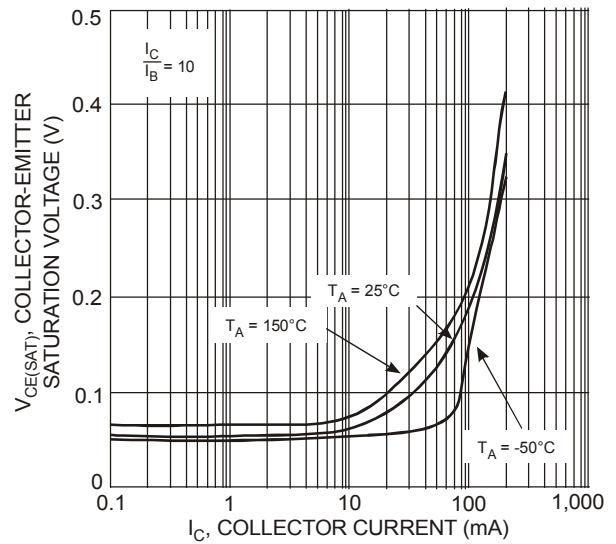
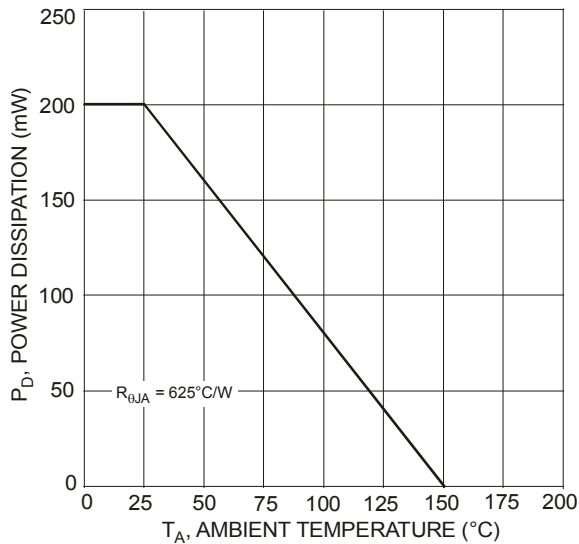

Package Outline Dimensions

Please see AP02002 at <http://www.diodes.com/datasheets/ap02002.pdf> for latest version.

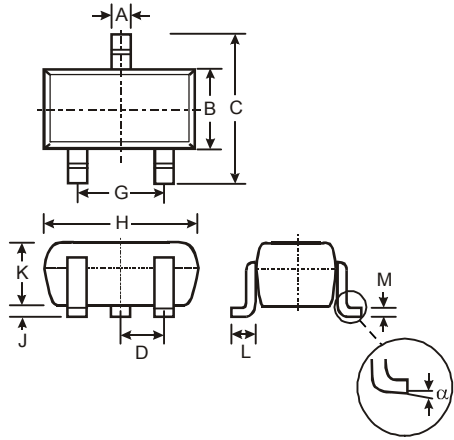

| SOT323 | | | |
|----------------------|------|------|------|
| Dim | Min | Max | Typ |
| A | 0.25 | 0.40 | 0.30 |
| B | 1.15 | 1.35 | 1.30 |
| C | 2.00 | 2.20 | 2.10 |
| D | - | - | 0.65 |
| G | 1.20 | 1.40 | 1.30 |
| H | 1.80 | 2.20 | 2.15 |
| J | 0.0 | 0.10 | 0.05 |
| K | 0.90 | 1.00 | 1.00 |
| L | 0.25 | 0.40 | 0.30 |
| M | 0.10 | 0.18 | 0.11 |
| α | 0° | 8° | - |
| All Dimensions in mm | | | |

Suggested Pad Layout

Please see AP02001 at <http://www.diodes.com/datasheets/ap02001.pdf> for the latest version.

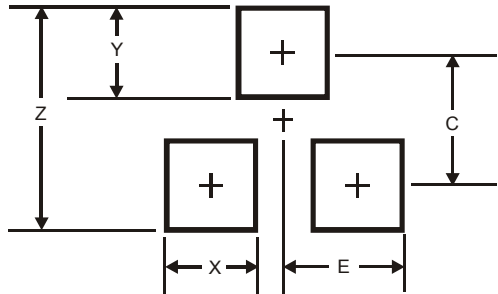

| Dimensions | Value (in mm) |
|------------|---------------|
| Z | 2.8 |
| X | 0.7 |
| Y | 0.9 |
| C | 1.9 |
| E | 1.0 |

IMPORTANT NOTICE

DIODES INCORPORATED MAKES NO WARRANTY OF ANY KIND, EXPRESS OR IMPLIED, WITH REGARDS TO THIS DOCUMENT, INCLUDING, BUT NOT LIMITED TO, THE IMPLIED WARRANTIES OF MERCHANTABILITY AND FITNESS FOR A PARTICULAR PURPOSE (AND THEIR EQUIVALENTS UNDER THE LAWS OF ANY JURISDICTION).

Diodes Incorporated and its subsidiaries reserve the right to make modifications, enhancements, improvements, corrections or other changes without further notice to this document and any product described herein. Diodes Incorporated does not assume any liability arising out of the application or use of this document or any product described herein; neither does Diodes Incorporated convey any license under its patent or trademark rights, nor the rights of others. Any Customer or user of this document or products described herein in such applications shall assume all risks of such use and will agree to hold Diodes Incorporated and all the companies whose products are represented on Diodes Incorporated website, harmless against all damages.

Diodes Incorporated does not warrant or accept any liability whatsoever in respect of any products purchased through unauthorized sales channel. Should Customers purchase or use Diodes Incorporated products for any unintended or unauthorized application, Customers shall indemnify and hold Diodes Incorporated and its representatives harmless against all claims, damages, expenses, and attorney fees arising out of, directly or indirectly, any claim of personal injury or death associated with such unintended or unauthorized application.

Products described herein may be covered by one or more United States, international or foreign patents pending. Product names and markings noted herein may also be covered by one or more United States, international or foreign trademarks.

This document is written in English but may be translated into multiple languages for reference. Only the English version of this document is the final and determinative format released by Diodes Incorporated.

LIFE SUPPORT

Diodes Incorporated products are specifically not authorized for use as critical components in life support devices or systems without the express written approval of the Chief Executive Officer of Diodes Incorporated. As used herein:

A. Life support devices or systems are devices or systems which:

1. are intended to implant into the body, or
2. support or sustain life and whose failure to perform when properly used in accordance with instructions for use provided in the labeling can be reasonably expected to result in significant injury to the user.

B. A critical component is any component in a life support device or system whose failure to perform can be reasonably expected to cause the failure of the life support device or to affect its safety or effectiveness.

Customers represent that they have all necessary expertise in the safety and regulatory ramifications of their life support devices or systems, and acknowledge and agree that they are solely responsible for all legal, regulatory and safety-related requirements concerning their products and any use of Diodes Incorporated products in such safety-critical, life support devices or systems, notwithstanding any devices- or systems-related information or support that may be provided by Diodes Incorporated. Further, Customers must fully indemnify Diodes Incorporated and its representatives against any damages arising out of the use of Diodes Incorporated products in such safety-critical, life support devices or systems.

Copyright © 2012, Diodes Incorporated

www.diodes.com



Стандарт Электрон Связь

Мы молодая и активно развивающаяся компания в области поставок электронных компонентов. Мы поставляем электронные компоненты отечественного и импортного производства напрямую от производителей и с крупнейших складов мира.

Благодаря сотрудничеству с мировыми поставщиками мы осуществляем комплексные и плановые поставки широчайшего спектра электронных компонентов.

Собственная эффективная логистика и склад в обеспечивает надежную поставку продукции в точно указанные сроки по всей России.

Мы осуществляем техническую поддержку нашим клиентам и предпродажную проверку качества продукции. На все поставляемые продукты мы предоставляем гарантию .

Осуществляем поставки продукции под контролем ВП МО РФ на предприятия военно-промышленного комплекса России , а также работаем в рамках 275 ФЗ с открытием отдельных счетов в уполномоченном банке. Система менеджмента качества компании соответствует требованиям ГОСТ ISO 9001.

Минимальные сроки поставки, гибкие цены, неограниченный ассортимент и индивидуальный подход к клиентам являются основой для выстраивания долгосрочного и эффективного сотрудничества с предприятиями радиоэлектронной промышленности, предприятиями ВПК и научно-исследовательскими институтами России.

С нами вы становитесь еще успешнее!

Наши контакты:

Телефон: +7 812 627 14 35

Электронная почта: sales@st-electron.ru

Адрес: 198099, Санкт-Петербург,
Промышленная ул, дом № 19, литера Н,
помещение 100-Н Офис 331