

CD40106B Types

CMOS Hex Schmitt Triggers

High-Voltage Types (20-Volt Rating)

■ CD40106B consists of six Schmitt-trigger circuits. Each circuit functions as an inverter with Schmitt-trigger action on the input. The trigger switches at different points for positive- and negative-going signals. The difference between the positive-going voltage (V_P) and the negative-going voltage (V_N) is defined as hysteresis voltage (V_H) (see Fig.6). The CD40106B types are supplied in 14-lead hermetic dual-in-line ceramic packages (F3A suffix), 14-lead dual-in-line plastic packages (E suffix), 14-lead small-outline packages (M, MT, M96, and NSR suffixes), and 14-lead thin shrink small-outline packages (PW and PWR suffixes).

Features:

- Schmitt-trigger action with no external components
- Hysteresis voltage (typ.) 0.9 V at $V_{DD} = 5\text{ V}$, 2.3 V at $V_{DD} = 10\text{ V}$, and 3.5 V at $V_{DD} = 15\text{ V}$
- Noise immunity greater than 50%
- No limit on input rise and fall times
- Standardized, symmetrical output characteristics
- 100% tested for quiescent current at 20 V
- Maximum input current of $1\ \mu\text{A}$ at 18 V over full package-temperature range; 100 nA at 18 V and 25°C
- Low V_{DD} to V_{SS} current during slow input ramp
- 5-V, 10-V, and 15-V parametric ratings
- Meets all requirements of JEDEC Tentative Standard No. 13B, "Standard Specifications for Description of 'B' Series CMOS Devices"

Applications:

- Wave and pulse shapers
- High-noise-environment systems
- Monostable multivibrators
- Astable multivibrators

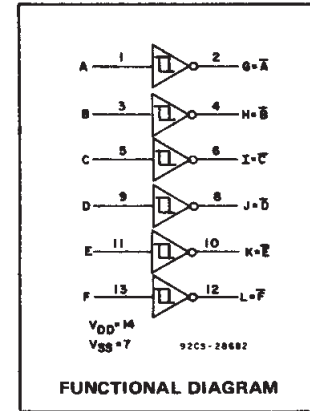

MAXIMUM RATINGS, Absolute-Maximum Values:

DC SUPPLY-VOLTAGE RANGE, (V_{DD})	-0.5V to +20V
Voltages referenced to V_{SS} Terminal)	-0.5V to $V_{DD} + 0.5\text{V}$
INPUT VOLTAGE RANGE, ALL INPUTS	-0.5V to $V_{DD} + 0.5\text{V}$
DC INPUT CURRENT, ANY ONE INPUT	$\pm 10\text{mA}$
POWER DISSIPATION PER PACKAGE (P_D):	
For $T_A = -55^\circ\text{C}$ to $+100^\circ\text{C}$	500mW
For $T_A = +100^\circ\text{C}$ to $+125^\circ\text{C}$	Derate Linearity at 12mW/ $^\circ\text{C}$ to 200mW
DEVICE DISSIPATION PER OUTPUT TRANSISTOR	
FOR $T_A = \text{FULL PACKAGE-TEMPERATURE RANGE (All Package Types)}$	100mW
OPERATING-TEMPERATURE RANGE (T_A)	-55°C to $+125^\circ\text{C}$
STORAGE TEMPERATURE RANGE (T_{stg})	-65°C to $+150^\circ\text{C}$
LEAD TEMPERATURE (DURING SOLDERING):	
At distance $1/16 \pm 1/32$ inch ($1.59 \pm 0.79\text{mm}$) from case for 10s max	$+265^\circ\text{C}$

RECOMMENDED OPERATING CONDITIONS

For maximum reliability, nominal operating conditions should be selected so that operation is always within the following ranges:

CHARACTERISTIC	LIMITS		UNITS
	MIN.	MAX.	
Supply-Voltage Range (For T_A Full Package-Temperature Range)	3	18	V

DYNAMIC ELECTRICAL CHARACTERISTICS

At $T_A = 25^\circ\text{C}$, Input $t_r, t_f = 20\text{ ns}$, $C_L = 50\text{ pF}$, $R_L = 200\text{ k}\Omega$

CHARACTERISTIC	TEST CONDITIONS	LIMITS		UNITS	
		V_{DD} (V)	TYP.		MAX.
Propagation Delay Time:		5	140	280	ns
		10	70	140	
		15	60	120	
Transition Time:		5	100	200	ns
		10	50	100	
		15	40	80	
Input Capacitance, C_{iN}	Any Input		5	7.5	pF

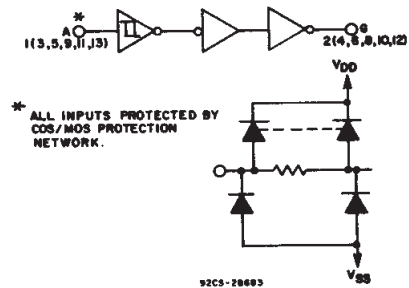

Fig.1 – Logic diagram (1 of 6 Schmitt triggers).

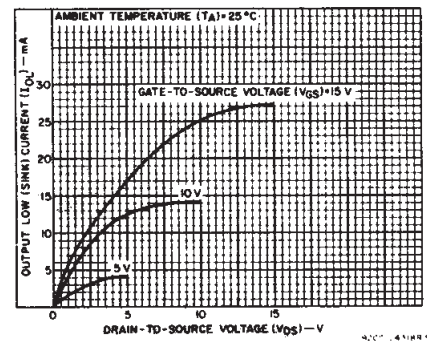

Fig.2 – Typical output low (sink) current characteristics.

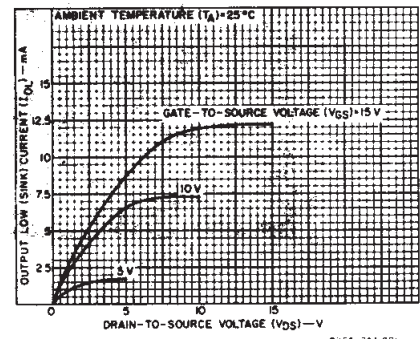

Fig.3 – Minimum output low (sink) current characteristics.

CD40106B Types

STATIC ELECTRICAL CHARACTERISTICS

CHARACTERISTIC	CONDITIONS			LIMITS AT INDICATED TEMPERATURES (°C)							UNITS
	V _O (V)	V _{IN} (V)	V _{DD} (V)	-55	-40	+85	+125	+25			
								Min.	Typ.	Max.	
Quiescent Device Current, I _{DD} Max.	-	0,5	5	1	1	30	30	-	0,02	1	μA
	-	0,10	10	2	2	60	60	-	0,02	2	
	-	0,15	15	4	4	120	120	-	0,02	4	
	-	0,20	20	20	20	600	600	-	0,04	20	
Positive Trigger Threshold Voltage V _P Min.	-	-	5	2,2	2,2	2,2	2,2	2,2	2,9	-	V
	-	-	10	4,6	4,6	4,6	4,6	4,6	5,9	-	
	-	-	15	6,8	6,8	6,8	6,8	6,8	8,8	-	
V _P Max.	-	-	5	3,6	3,6	3,6	3,6	-	2,9	3,6	V
	-	-	10	7,1	7,1	7,1	7,1	-	5,9	7,1	
	-	-	15	10,8	10,8	10,8	10,8	-	8,8	10,8	
Negative Trigger Threshold Voltage V _N Min.	-	-	5	0,9	0,9	0,9	0,9	0,9	1,9	-	V
	-	-	10	2,5	2,5	2,5	2,5	2,5	3,9	-	
	-	-	15	4	4	4	4	4	5,8	-	
V _N Max.	-	-	5	2,8	2,8	2,8	2,8	-	1,9	2,8	V
	-	-	10	5,2	5,2	5,2	5,2	-	3,9	5,2	
	-	-	15	7,4	7,4	7,4	7,4	-	5,8	7,4	
Hysteresis Voltage V _H Min.	-	-	5	0,3	0,3	0,3	0,3	0,3	0,9	-	V
	-	-	10	1,2	1,2	1,2	1,2	1,2	2,3	-	
	-	-	15	1,6	1,6	1,6	1,6	1,6	3,5	-	
V _H Max.	-	-	5	1,6	1,6	1,6	1,6	-	0,9	1,6	V
	-	-	10	3,4	3,4	3,4	3,4	-	2,3	3,4	
	-	-	15	5	5	5	5	-	3,5	5	
Output Low (Sink) Current, I _{OL} Min.	0,4	0,5	5	0,64	0,61	0,42	0,36	0,51	1	-	mA
	0,5	0,10	10	1,6	1,5	1,1	0,9	1,3	2,6	-	
	1,5	0,15	15	4,2	4	2,8	2,4	3,4	6,8	-	
Output High (Source) Current, I _{OH} Min.	4,6	0,5	5	-0,64	-0,61	-0,42	-0,36	-0,51	-1	-	mA
	2,5	0,5	5	-2	-1,8	-1,3	-1,15	-1,6	-3,2	-	
	9,5	0,10	10	-1,6	-1,5	-1,1	-0,9	-1,3	-2,6	-	
	13,5	0,15	15	-4,2	-4	-2,8	-2,4	-3,4	-6,8	-	
Output Voltage Low-Level, V _{OL} Max.	-	5	5	0,05				-	0	0,05	V
	-	10	10	0,05				-	0	0,05	
	-	15	15	0,05				-	0	0,05	
Output Voltage High Level, V _{OH} Min.	-	0	5	4,95				4,95	5	-	V
	-	0	10	9,95				9,95	10	-	
	-	0	15	14,95				14,95	15	-	
Input Current, I _{IN} Max.	-	0,18	18	±0,1	±0,1	±1	±1	-	±10 ⁻⁵	±0,1	μA

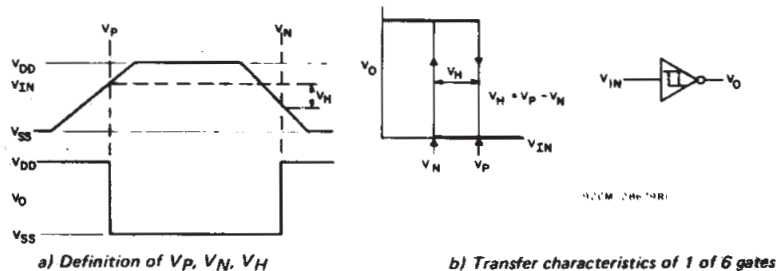

Fig. 6 - Hysteresis definition, characteristics, and test set-up.

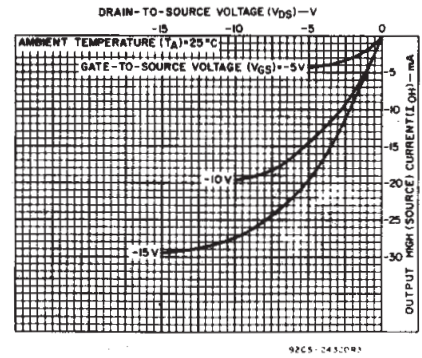

Fig. 4 - Typical output high (source) current characteristics.

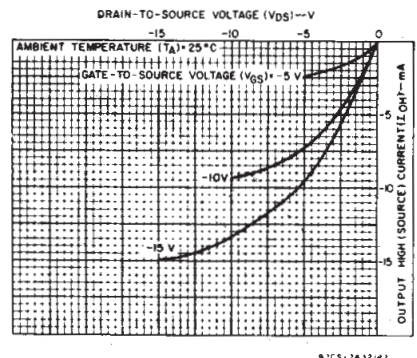

Fig. 5 - Minimum output high (source) current characteristics.

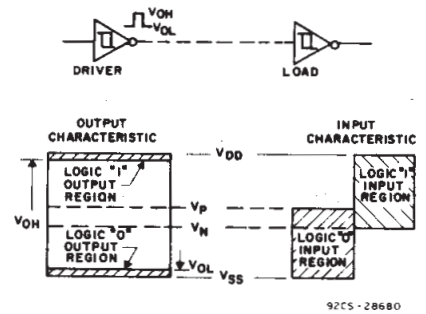

Fig. 7 - Input and output characteristics.

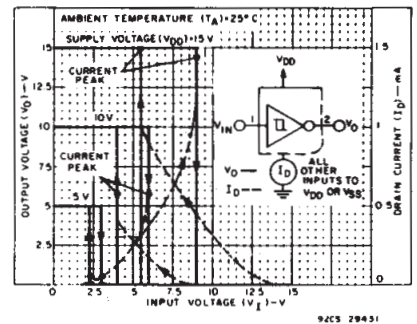

Fig. 8 - Typical current and voltage transfer characteristics.

CD40106B Types

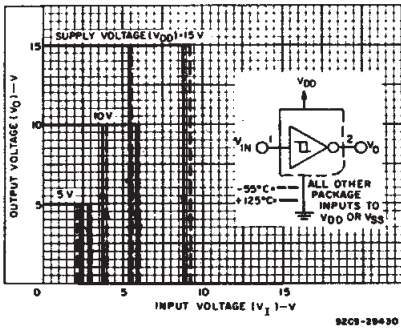

Fig. 9 - Typical voltage transfer characteristics as a function of temperature.

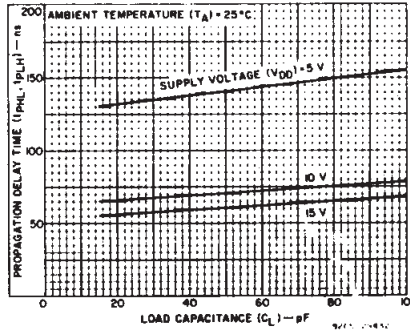

Fig. 10 - Typical propagation delay time as a function of load capacitance.

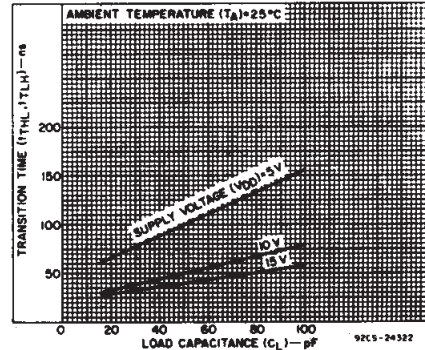

Fig. 11 - Typical transition time as a function of load capacitance.

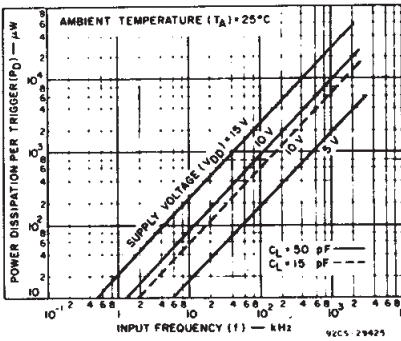

Fig. 12 - Typical power dissipation per trigger as a function of input frequency.

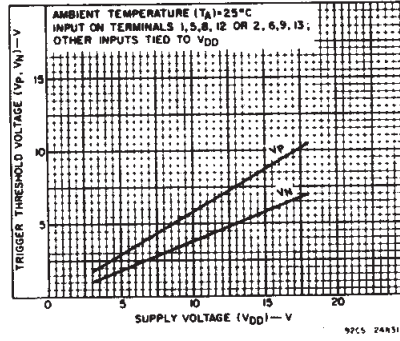

Fig. 13 - Typical trigger threshold voltage as a function of supply voltage.

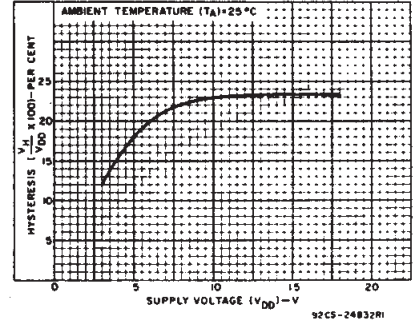

Fig. 14 - Typical per cent hysteresis as a function of supply voltage.

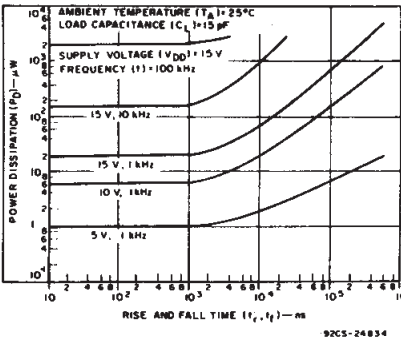

Fig. 15 - Typical power dissipation as a function of rise and fall times.

APPLICATIONS

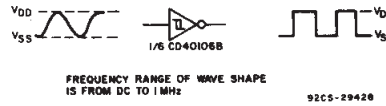

Fig. 16 - Wave shaper.

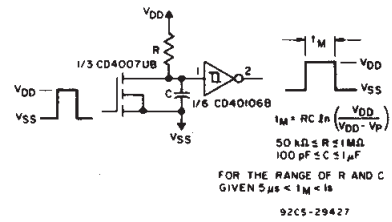

Fig. 17 - Monostable multivibrator.

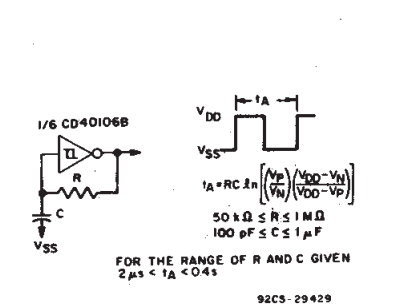

Fig. 18 - Astable multivibrator.

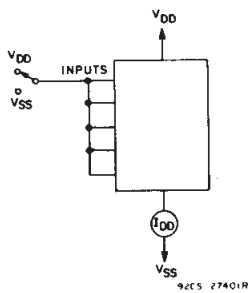

Fig. 19 - Quiescent device current test circuit.

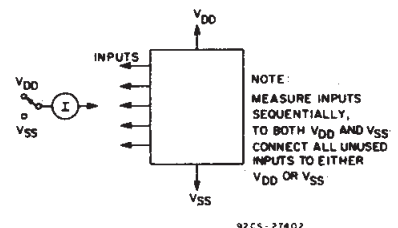

Fig. 20 - Input current test circuit.

CD40106B Types

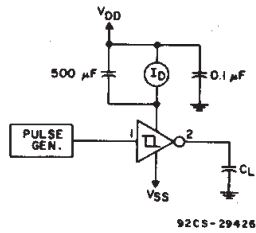
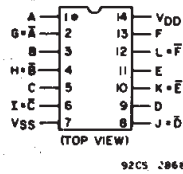
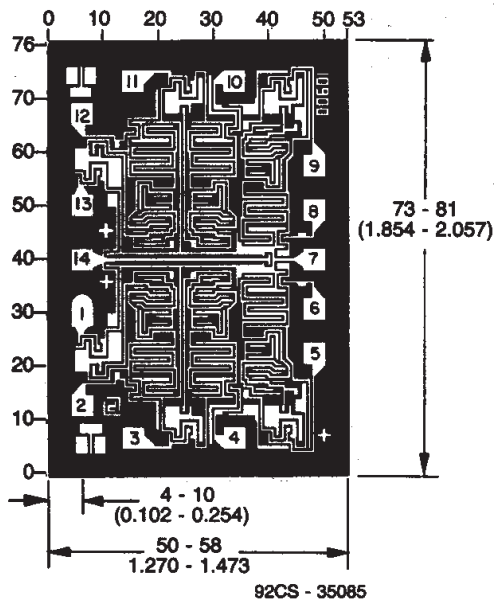

Fig.21 – Dynamic power dissipation test circuit.



TERMINAL ASSIGNMENT



Dimensions and Pad Layout for CD40106BH

Dimensions in parentheses are in millimeters and are derived from the basic inch dimensions as indicated. Grid graduations are in mils (10^{-3} inch).

3
COMMERCIAL CMOS
HIGH VOLTAGE ICs

PACKAGING INFORMATION

Orderable Device	Status (1)	Package Type	Package Drawing	Pins	Package Qty	Eco Plan (2)	Lead/Ball Finish	MSL Peak Temp (3)	Op Temp (°C)	Top-Side Markings (4)	Samples
CD40106BE	ACTIVE	PDIP	N	14	25	Pb-Free (RoHS)	CU NIPDAU	N / A for Pkg Type	-55 to 125	CD40106BE	Samples
CD40106BEE4	ACTIVE	PDIP	N	14	25	Pb-Free (RoHS)	CU NIPDAU	N / A for Pkg Type	-55 to 125	CD40106BE	Samples
CD40106BF	ACTIVE	CDIP	J	14	1	TBD	A42	N / A for Pkg Type	-55 to 125	CD40106BF	Samples
CD40106BF3A	ACTIVE	CDIP	J	14	1	TBD	A42	N / A for Pkg Type	-55 to 125	CD40106BF3A	Samples
CD40106BK	OBSOLETE	CFP	WR	14		TBD	Call TI	Call TI			
CD40106BM	ACTIVE	SOIC	D	14	50	Green (RoHS & no Sb/Br)	CU NIPDAU	Level-1-260C-UNLIM	-55 to 125	CD40106BM	Samples
CD40106BM96	ACTIVE	SOIC	D	14	2500	Green (RoHS & no Sb/Br)	CU NIPDAU	Level-1-260C-UNLIM	-55 to 125	CD40106BM	Samples
CD40106BM96E4	ACTIVE	SOIC	D	14	2500	Green (RoHS & no Sb/Br)	CU NIPDAU	Level-1-260C-UNLIM	-55 to 125	CD40106BM	Samples
CD40106BM96G4	ACTIVE	SOIC	D	14	2500	Green (RoHS & no Sb/Br)	CU NIPDAU	Level-1-260C-UNLIM	-55 to 125	CD40106BM	Samples
CD40106BME4	ACTIVE	SOIC	D	14	50	Green (RoHS & no Sb/Br)	CU NIPDAU	Level-1-260C-UNLIM	-55 to 125	CD40106BM	Samples
CD40106BMG4	ACTIVE	SOIC	D	14	50	Green (RoHS & no Sb/Br)	CU NIPDAU	Level-1-260C-UNLIM	-55 to 125	CD40106BM	Samples
CD40106BMT	ACTIVE	SOIC	D	14	250	Green (RoHS & no Sb/Br)	CU NIPDAU	Level-1-260C-UNLIM	-55 to 125	CD40106BM	Samples
CD40106BMTE4	ACTIVE	SOIC	D	14	250	Green (RoHS & no Sb/Br)	CU NIPDAU	Level-1-260C-UNLIM	-55 to 125	CD40106BM	Samples
CD40106BMTG4	ACTIVE	SOIC	D	14	250	Green (RoHS & no Sb/Br)	CU NIPDAU	Level-1-260C-UNLIM	-55 to 125	CD40106BM	Samples
CD40106BNSR	ACTIVE	SO	NS	14	2000	Green (RoHS & no Sb/Br)	CU NIPDAU	Level-1-260C-UNLIM	-55 to 125	CD40106B	Samples
CD40106BNSRE4	ACTIVE	SO	NS	14	2000	Green (RoHS & no Sb/Br)	CU NIPDAU	Level-1-260C-UNLIM	-55 to 125	CD40106B	Samples
CD40106BNSRG4	ACTIVE	SO	NS	14	2000	Green (RoHS & no Sb/Br)	CU NIPDAU	Level-1-260C-UNLIM	-55 to 125	CD40106B	Samples
CD40106BPW	ACTIVE	TSSOP	PW	14	90	Green (RoHS & no Sb/Br)	CU NIPDAU	Level-1-260C-UNLIM	-55 to 125	CM0106B	Samples

Orderable Device	Status (1)	Package Type	Package Drawing	Pins	Package Qty	Eco Plan (2)	Lead/Ball Finish	MSL Peak Temp (3)	Op Temp (°C)	Top-Side Markings (4)	Samples
CD40106BPWE4	ACTIVE	TSSOP	PW	14	90	Green (RoHS & no Sb/Br)	CU NIPDAU	Level-1-260C-UNLIM	-55 to 125	CM0106B	Samples
CD40106BPWG4	ACTIVE	TSSOP	PW	14	90	Green (RoHS & no Sb/Br)	CU NIPDAU	Level-1-260C-UNLIM	-55 to 125	CM0106B	Samples
CD40106BPWR	ACTIVE	TSSOP	PW	14	2000	Green (RoHS & no Sb/Br)	CU NIPDAU	Level-1-260C-UNLIM	-55 to 125	CM0106B	Samples
CD40106BPWRE4	ACTIVE	TSSOP	PW	14	2000	Green (RoHS & no Sb/Br)	CU NIPDAU	Level-1-260C-UNLIM	-55 to 125	CM0106B	Samples
CD40106BPWRG4	ACTIVE	TSSOP	PW	14	2000	Green (RoHS & no Sb/Br)	CU NIPDAU	Level-1-260C-UNLIM	-55 to 125	CM0106B	Samples

(1) The marketing status values are defined as follows:

ACTIVE: Product device recommended for new designs.

LIFEBUY: TI has announced that the device will be discontinued, and a lifetime-buy period is in effect.

NRND: Not recommended for new designs. Device is in production to support existing customers, but TI does not recommend using this part in a new design.

PREVIEW: Device has been announced but is not in production. Samples may or may not be available.

OBSOLETE: TI has discontinued the production of the device.

(2) Eco Plan - The planned eco-friendly classification: Pb-Free (RoHS), Pb-Free (RoHS Exempt), or Green (RoHS & no Sb/Br) - please check <http://www.ti.com/productcontent> for the latest availability information and additional product content details.

TBD: The Pb-Free/Green conversion plan has not been defined.

Pb-Free (RoHS): TI's terms "Lead-Free" or "Pb-Free" mean semiconductor products that are compatible with the current RoHS requirements for all 6 substances, including the requirement that lead not exceed 0.1% by weight in homogeneous materials. Where designed to be soldered at high temperatures, TI Pb-Free products are suitable for use in specified lead-free processes.

Pb-Free (RoHS Exempt): This component has a RoHS exemption for either 1) lead-based flip-chip solder bumps used between the die and package, or 2) lead-based die adhesive used between the die and leadframe. The component is otherwise considered Pb-Free (RoHS compatible) as defined above.

Green (RoHS & no Sb/Br): TI defines "Green" to mean Pb-Free (RoHS compatible), and free of Bromine (Br) and Antimony (Sb) based flame retardants (Br or Sb do not exceed 0.1% by weight in homogeneous material)

(3) MSL, Peak Temp. -- The Moisture Sensitivity Level rating according to the JEDEC industry standard classifications, and peak solder temperature.

(4) Only one of markings shown within the brackets will appear on the physical device.

Important Information and Disclaimer: The information provided on this page represents TI's knowledge and belief as of the date that it is provided. TI bases its knowledge and belief on information provided by third parties, and makes no representation or warranty as to the accuracy of such information. Efforts are underway to better integrate information from third parties. TI has taken and continues to take reasonable steps to provide representative and accurate information but may not have conducted destructive testing or chemical analysis on incoming materials and chemicals. TI and TI suppliers consider certain information to be proprietary, and thus CAS numbers and other limited information may not be available for release.

In no event shall TI's liability arising out of such information exceed the total purchase price of the TI part(s) at issue in this document sold by TI to Customer on an annual basis.

OTHER QUALIFIED VERSIONS OF CD40106B, CD40106B-MIL :

- Catalog: [CD40106B](#)
- Military: [CD40106B-MIL](#)

NOTE: Qualified Version Definitions:

- Catalog - TI's standard catalog product
- Military - QML certified for Military and Defense Applications

TAPE AND REEL INFORMATION

QUADRANT ASSIGNMENTS FOR PIN 1 ORIENTATION IN TAPE

*All dimensions are nominal

Device	Package Type	Package Drawing	Pins	SPQ	Reel Diameter (mm)	Reel Width W1 (mm)	A0 (mm)	B0 (mm)	K0 (mm)	P1 (mm)	W (mm)	Pin1 Quadrant
CD40106BM96	SOIC	D	14	2500	330.0	16.4	6.5	9.0	2.1	8.0	16.0	Q1
CD40106BM96G4	SOIC	D	14	2500	330.0	16.4	6.5	9.0	2.1	8.0	16.0	Q1
CD40106BMT	SOIC	D	14	250	330.0	16.4	6.5	9.0	2.1	8.0	16.0	Q1
CD40106BNSR	SO	NS	14	2000	330.0	16.4	8.2	10.5	2.5	12.0	16.0	Q1
CD40106BPWR	TSSOP	PW	14	2000	330.0	12.4	6.9	5.6	1.6	8.0	12.0	Q1

TAPE AND REEL BOX DIMENSIONS



*All dimensions are nominal

Device	Package Type	Package Drawing	Pins	SPQ	Length (mm)	Width (mm)	Height (mm)
CD40106BM96	SOIC	D	14	2500	367.0	367.0	38.0
CD40106BM96G4	SOIC	D	14	2500	367.0	367.0	38.0
CD40106BMT	SOIC	D	14	250	367.0	367.0	38.0
CD40106BNSR	SO	NS	14	2000	367.0	367.0	38.0
CD40106BPWR	TSSOP	PW	14	2000	367.0	367.0	35.0

J (R-GDIP-T**)

14 LEADS SHOWN

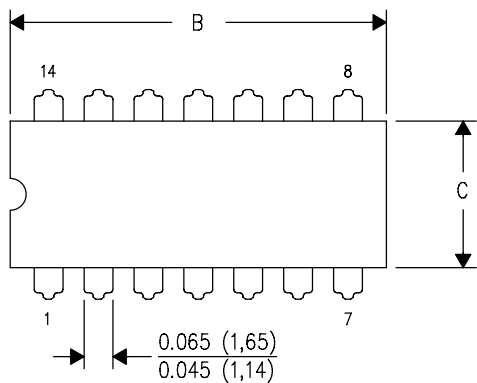
CERAMIC DUAL IN-LINE PACKAGE



DIM \ PINS **	14	16	18	20
A	0.300 (7,62) BSC	0.300 (7,62) BSC	0.300 (7,62) BSC	0.300 (7,62) BSC
B MAX	0.785 (19,94)	.840 (21,34)	0.960 (24,38)	1.060 (26,92)
B MIN	—	—	—	—
C MAX	0.300 (7,62)	0.300 (7,62)	0.310 (7,87)	0.300 (7,62)
C MIN	0.245 (6,22)	0.245 (6,22)	0.220 (5,59)	0.245 (6,22)

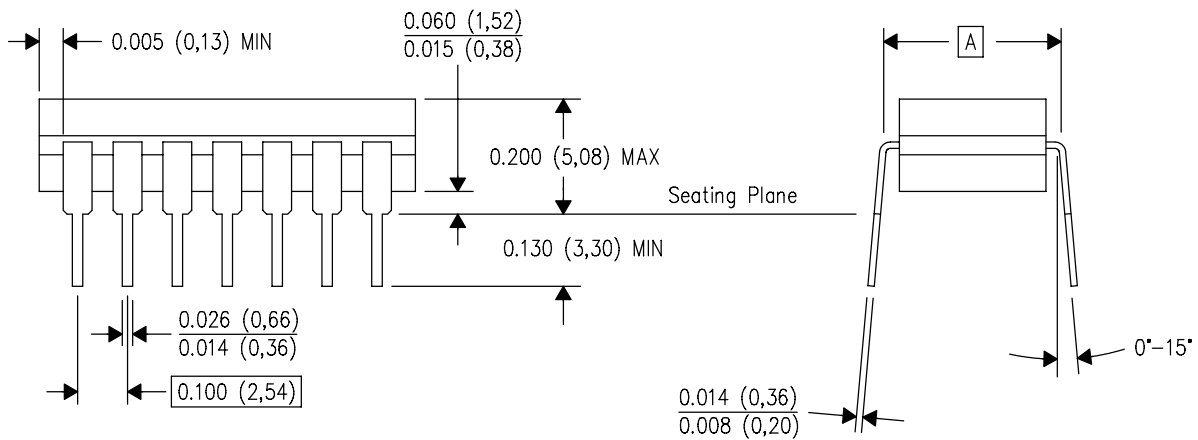

4040083/F 03/03

- NOTES:
- All linear dimensions are in inches (millimeters).
 - This drawing is subject to change without notice.
 - This package is hermetically sealed with a ceramic lid using glass frit.
 - Index point is provided on cap for terminal identification only on press ceramic glass frit seal only.
 - Falls within MIL STD 1835 GDIP1-T14, GDIP1-T16, GDIP1-T18 and GDIP1-T20.

N (R-PDIP-T**)

PLASTIC DUAL-IN-LINE PACKAGE

16 PINS SHOWN

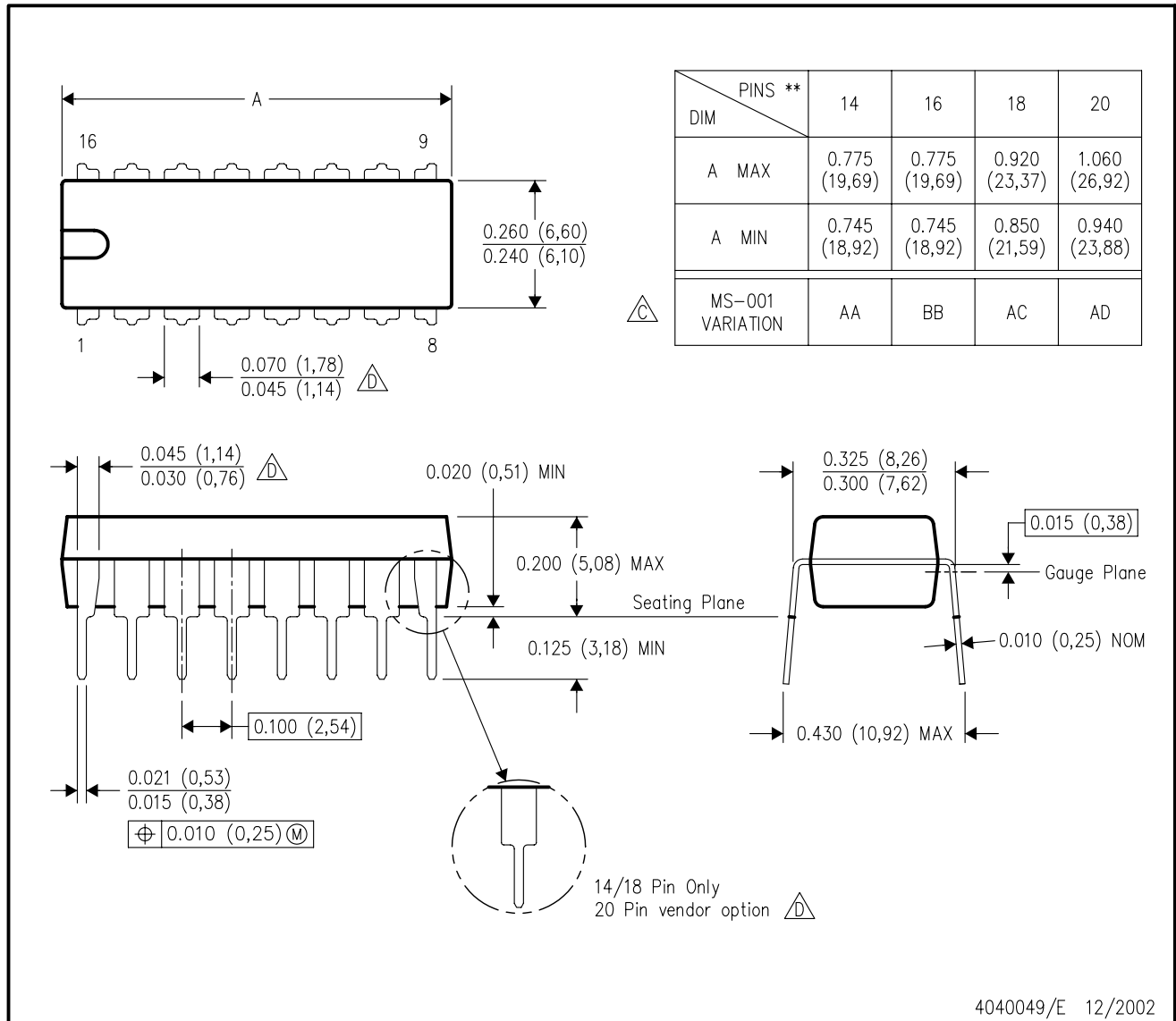



- NOTES:
- A. All linear dimensions are in inches (millimeters).
 - B. This drawing is subject to change without notice.
 - Falls within JEDEC MS-001, except 18 and 20 pin minimum body length (Dim A).
 - The 20 pin end lead shoulder width is a vendor option, either half or full width.

D (R-PDSO-G14)

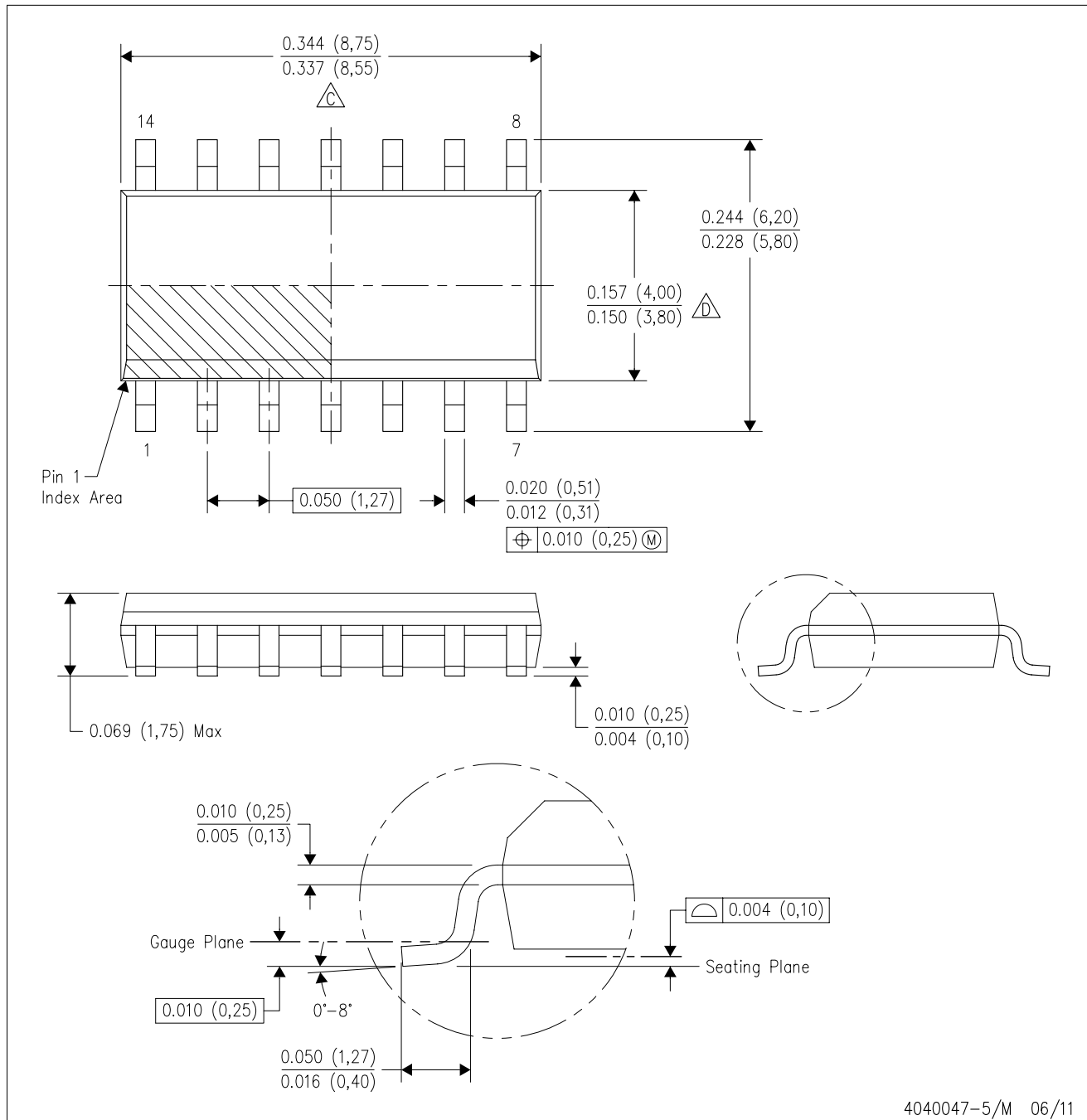
PLASTIC SMALL OUTLINE



- NOTES:
- A. All linear dimensions are in inches (millimeters).
 - B. This drawing is subject to change without notice.
 -  Body length does not include mold flash, protrusions, or gate burrs. Mold flash, protrusions, or gate burrs shall not exceed 0.006 (0,15) each side.
 -  Body width does not include interlead flash. Interlead flash shall not exceed 0.017 (0,43) each side.
 - E. Reference JEDEC MS-012 variation AB.

D (R-PDSO-G14)

PLASTIC SMALL OUTLINE



4211283-3/E 08/12

- NOTES:
- All linear dimensions are in millimeters.
 - This drawing is subject to change without notice.
 - Publication IPC-7351 is recommended for alternate designs.
 - Laser cutting apertures with trapezoidal walls and also rounding corners will offer better paste release. Customers should contact their board assembly site for stencil design recommendations. Refer to IPC-7525 for other stencil recommendations.
 - Customers should contact their board fabrication site for solder mask tolerances between and around signal pads.

PW (R-PDSO-G14)

PLASTIC SMALL OUTLINE

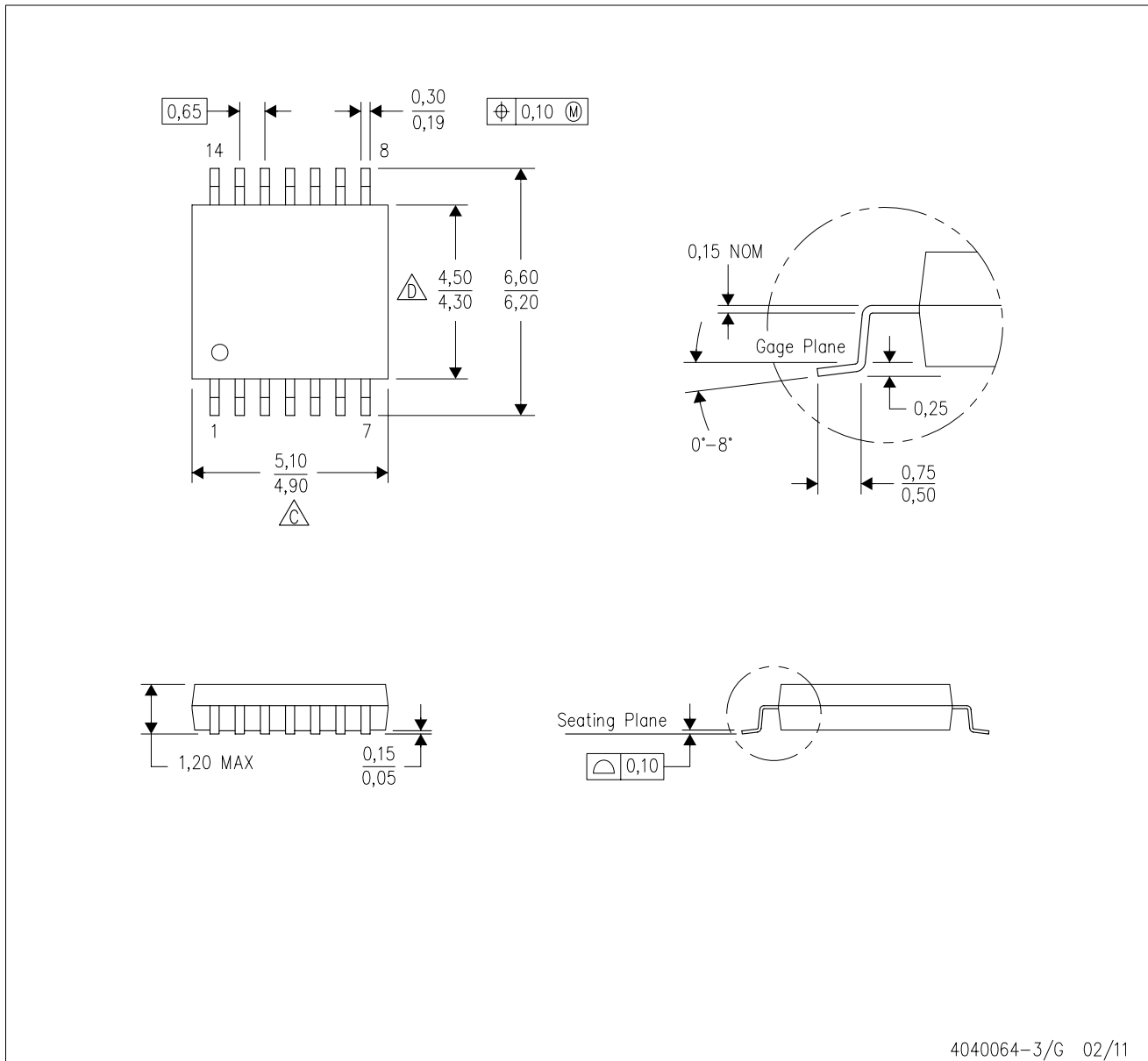

4040064-3/G 02/11

- NOTES:
- A. All linear dimensions are in millimeters. Dimensioning and tolerancing per ASME Y14.5M-1994.
 - B. This drawing is subject to change without notice.
 - C. Body length does not include mold flash, protrusions, or gate burrs. Mold flash, protrusions, or gate burrs shall not exceed 0,15 each side.
 - D. Body width does not include interlead flash. Interlead flash shall not exceed 0,25 each side.
 - E. Falls within JEDEC MO-153

PW (R-PDSO-G14)

PLASTIC SMALL OUTLINE

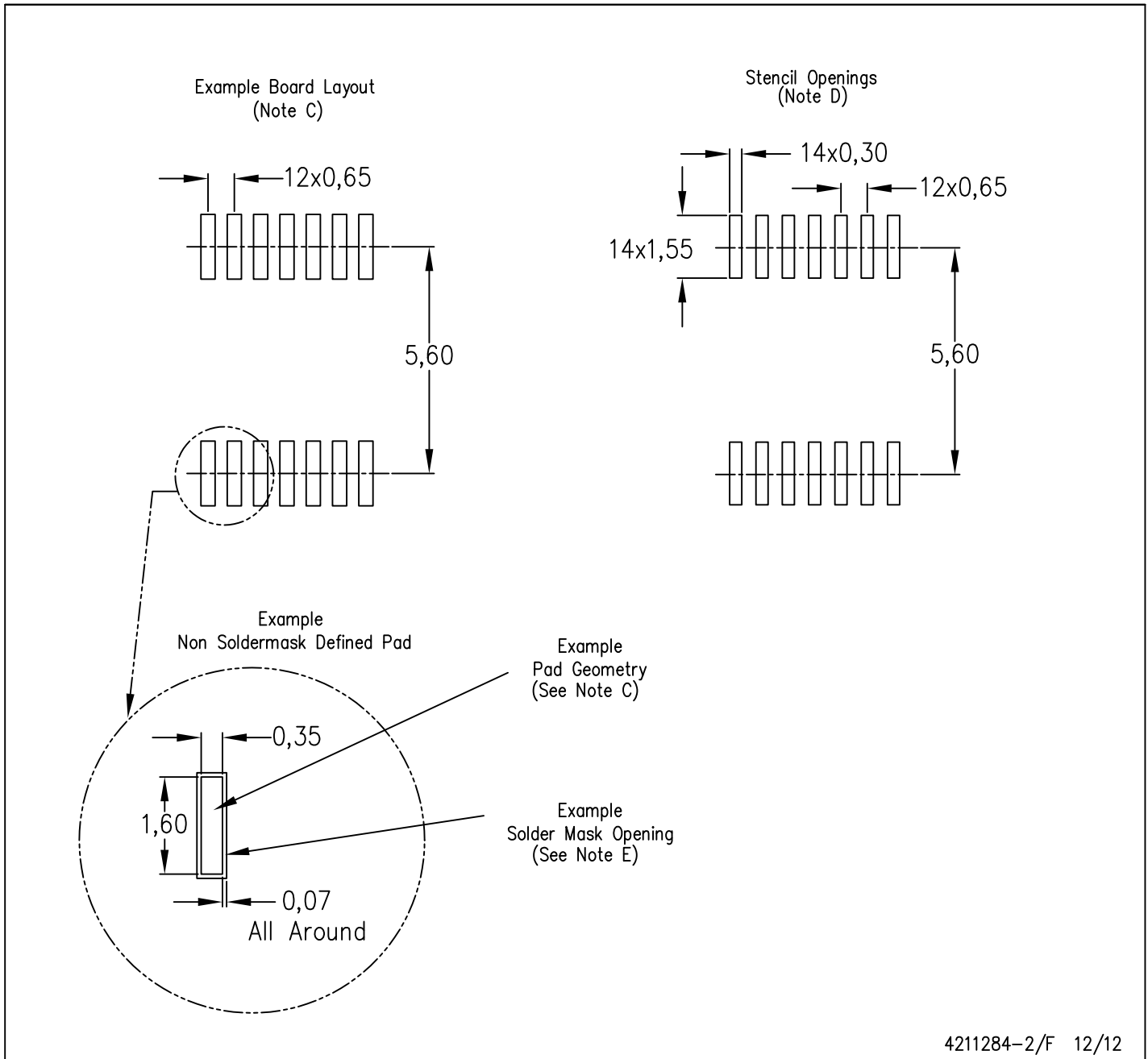

- NOTES:
- All linear dimensions are in millimeters.
 - This drawing is subject to change without notice.
 - Publication IPC-7351 is recommended for alternate designs.
 - Laser cutting apertures with trapezoidal walls and also rounding corners will offer better paste release. Customers should contact their board assembly site for stencil design recommendations. Refer to IPC-7525 for other stencil recommendations.
 - Customers should contact their board fabrication site for solder mask tolerances between and around signal pads.

MECHANICAL DATA

NS (R-PDSO-G**)

PLASTIC SMALL-OUTLINE PACKAGE

14-PINS SHOWN



- NOTES:
- A. All linear dimensions are in millimeters.
 - B. This drawing is subject to change without notice.
 - C. Body dimensions do not include mold flash or protrusion, not to exceed 0,15.

IMPORTANT NOTICE

Texas Instruments Incorporated and its subsidiaries (TI) reserve the right to make corrections, enhancements, improvements and other changes to its semiconductor products and services per JESD46, latest issue, and to discontinue any product or service per JESD48, latest issue. Buyers should obtain the latest relevant information before placing orders and should verify that such information is current and complete. All semiconductor products (also referred to herein as "components") are sold subject to TI's terms and conditions of sale supplied at the time of order acknowledgment.

TI warrants performance of its components to the specifications applicable at the time of sale, in accordance with the warranty in TI's terms and conditions of sale of semiconductor products. Testing and other quality control techniques are used to the extent TI deems necessary to support this warranty. Except where mandated by applicable law, testing of all parameters of each component is not necessarily performed.

TI assumes no liability for applications assistance or the design of Buyers' products. Buyers are responsible for their products and applications using TI components. To minimize the risks associated with Buyers' products and applications, Buyers should provide adequate design and operating safeguards.

TI does not warrant or represent that any license, either express or implied, is granted under any patent right, copyright, mask work right, or other intellectual property right relating to any combination, machine, or process in which TI components or services are used. Information published by TI regarding third-party products or services does not constitute a license to use such products or services or a warranty or endorsement thereof. Use of such information may require a license from a third party under the patents or other intellectual property of the third party, or a license from TI under the patents or other intellectual property of TI.

Reproduction of significant portions of TI information in TI data books or data sheets is permissible only if reproduction is without alteration and is accompanied by all associated warranties, conditions, limitations, and notices. TI is not responsible or liable for such altered documentation. Information of third parties may be subject to additional restrictions.

Resale of TI components or services with statements different from or beyond the parameters stated by TI for that component or service voids all express and any implied warranties for the associated TI component or service and is an unfair and deceptive business practice. TI is not responsible or liable for any such statements.

Buyer acknowledges and agrees that it is solely responsible for compliance with all legal, regulatory and safety-related requirements concerning its products, and any use of TI components in its applications, notwithstanding any applications-related information or support that may be provided by TI. Buyer represents and agrees that it has all the necessary expertise to create and implement safeguards which anticipate dangerous consequences of failures, monitor failures and their consequences, lessen the likelihood of failures that might cause harm and take appropriate remedial actions. Buyer will fully indemnify TI and its representatives against any damages arising out of the use of any TI components in safety-critical applications.

In some cases, TI components may be promoted specifically to facilitate safety-related applications. With such components, TI's goal is to help enable customers to design and create their own end-product solutions that meet applicable functional safety standards and requirements. Nonetheless, such components are subject to these terms.

No TI components are authorized for use in FDA Class III (or similar life-critical medical equipment) unless authorized officers of the parties have executed a special agreement specifically governing such use.

Only those TI components which TI has specifically designated as military grade or "enhanced plastic" are designed and intended for use in military/aerospace applications or environments. Buyer acknowledges and agrees that any military or aerospace use of TI components which have **not** been so designated is solely at the Buyer's risk, and that Buyer is solely responsible for compliance with all legal and regulatory requirements in connection with such use.

TI has specifically designated certain components as meeting ISO/TS16949 requirements, mainly for automotive use. In any case of use of non-designated products, TI will not be responsible for any failure to meet ISO/TS16949.

Products

Audio	www.ti.com/audio
Amplifiers	amplifier.ti.com
Data Converters	dataconverter.ti.com
DLP® Products	www.dlp.com
DSP	dsp.ti.com
Clocks and Timers	www.ti.com/clocks
Interface	interface.ti.com
Logic	logic.ti.com
Power Mgmt	power.ti.com
Microcontrollers	microcontroller.ti.com
RFID	www.ti-rfid.com
OMAP Applications Processors	www.ti.com/omap
Wireless Connectivity	www.ti.com/wirelessconnectivity

Applications

Automotive and Transportation	www.ti.com/automotive
Communications and Telecom	www.ti.com/communications
Computers and Peripherals	www.ti.com/computers
Consumer Electronics	www.ti.com/consumer-apps
Energy and Lighting	www.ti.com/energy
Industrial	www.ti.com/industrial
Medical	www.ti.com/medical
Security	www.ti.com/security
Space, Avionics and Defense	www.ti.com/space-avionics-defense
Video and Imaging	www.ti.com/video

TI E2E Community

e2e.ti.com



**Стандарт
Электрон
Связь**

Мы молодая и активно развивающаяся компания в области поставок электронных компонентов. Мы поставляем электронные компоненты отечественного и импортного производства напрямую от производителей и с крупнейших складов мира.

Благодаря сотрудничеству с мировыми поставщиками мы осуществляем комплексные и плановые поставки широчайшего спектра электронных компонентов.

Собственная эффективная логистика и склад в обеспечивает надежную поставку продукции в точно указанные сроки по всей России.

Мы осуществляем техническую поддержку нашим клиентам и предпродажную проверку качества продукции. На все поставляемые продукты мы предоставляем гарантию .

Осуществляем поставки продукции под контролем ВП МО РФ на предприятия военно-промышленного комплекса России , а также работаем в рамках 275 ФЗ с открытием отдельных счетов в уполномоченном банке. Система менеджмента качества компании соответствует требованиям ГОСТ ISO 9001.

Минимальные сроки поставки, гибкие цены, неограниченный ассортимент и индивидуальный подход к клиентам являются основой для выстраивания долгосрочного и эффективного сотрудничества с предприятиями радиоэлектронной промышленности, предприятиями ВПК и научно-исследовательскими институтами России.

С нами вы становитесь еще успешнее!

Наши контакты:

Телефон: +7 812 627 14 35

Электронная почта: sales@st-electron.ru

Адрес: 198099, Санкт-Петербург,
Промышленная ул, дом № 19, литера Н,
помещение 100-Н Офис 331