

HA1631S01/02/03/04 Series

Single CMOS Comparator
(Push Pull/Open Drain Output)

R03DS0085EJ0500

Rev.5.00

Jul 01, 2015

Description

The HA1631S01/02/03/04 are low power single CMOS Comparator featuring low voltage operation with typical current supply of 5 μ A/50 μ A. They are designed to operate from a single power supply. HA1631S01/02 have push-pull full swing outputs that allow direct connections to logic devices. The Open Drain version HA1631S03/04 enable Output Level shifting through external pull up resistors. Available in an ultra-small CMPAK-5 package, they occupy only 1/8 the area of the SOP-8 package.

Features

- Low supply current
 HA1631S01/03 : $I_{DDtyp} = 5 \mu A$ ($V_{DD} = 3.0 V$)
 HA1631S02/04 : $I_{DDtyp} = 50 \mu A$ ($V_{DD} = 3.0 V$)
- Low voltage operation : $V_{DD} = 1.8$ to $5.5 V$
- Low input offset voltage : $V_{IOmax} = 5 mV$
- Low input bias current : $I_{IBtyp} = 1 pA$
- Maximum output voltage : $V_{OHmin} = 2.9 V$ (at $V_{DD} = 3.0 V$)
- Input common voltage range includes ground
- On-chip ESD protection
- Available in CMPAK-5 and MPAK-5 package using Pb free lead frame

Ordering Information

Type No.	Package Name	Package Code
HA1631S01CM	CMPAK-5	PTSP0005ZC-A
HA1631S02CM		
HA1631S03CM		
HA1631S04CM		
HA1631S01LP	MPAK-5	PLSP0005ZB-A
HA1631S02LP		
HA1631S03LP		
HA1631S04LP		

Pin Arrangement

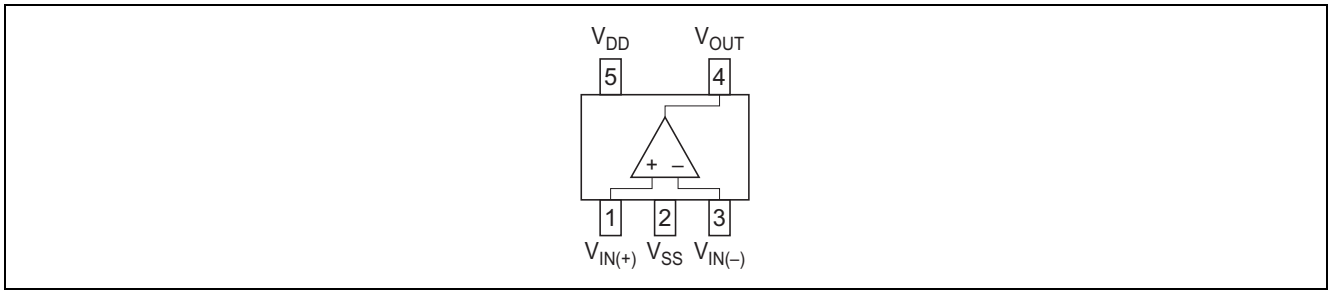

Equivalent Circuit

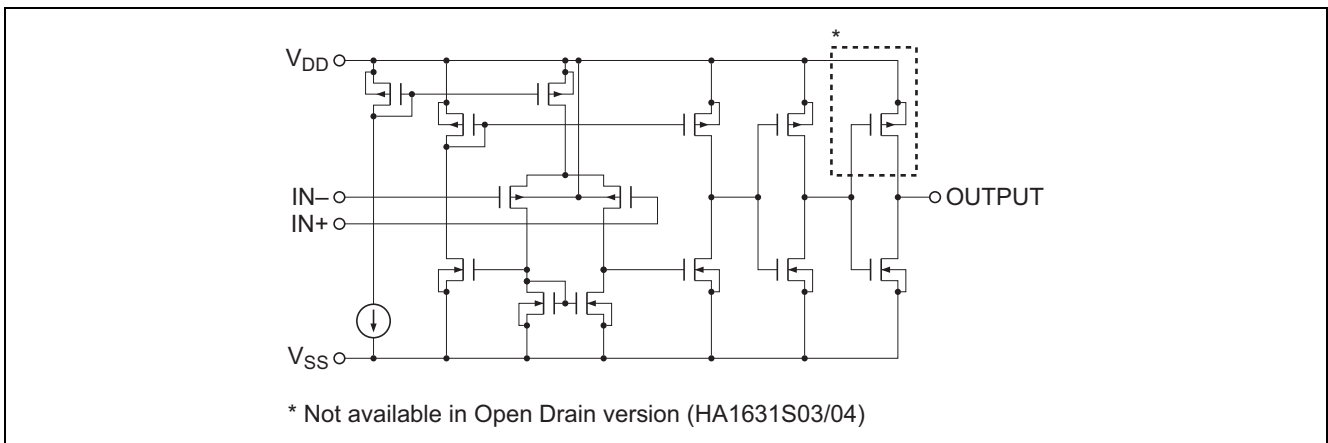

Absolute Maximum Ratings

(Ta = 25°C)

Item	Symbol	Ratings	Unit	Remarks
Supply voltage	V _{DD}	7.0	V	
Differential input voltage	V _{IN(diff)}	-V _{DD} to +V _{DD}	V	Note 1
Input voltage	V _{IN}	-0.1 to +V _{DD}	V	
Output current	I _{OUT}	28	mA	Note 2
Power dissipation	P _T	80/120	mW	CMPAK-5/MPAK-5
Operating temperature	T _{opr}	-40 to +85	°C	
Storage temperature	T _{stg}	-55 to +125	°C	

- Notes: 1. Do not apply input voltage exceeding V_{DD} or 7 V.
 2. The maximum output current is the maximum allowable value for continuous operation.

Electrical Characteristics

(Ta = 25°C, V_{DD} = 3.0 V, V_{SS} = 0 V)

Item	Symbol	Min	Typ	Max	Unit	Test Conditions	
Input offset voltage	V _{IO}	—	—	5	mV	V _{IN} = V _{DD} /2, R _L = 1MΩ	
Input bias current	I _{IB}	—	(1)	100	pA	V _{IN} = V _{DD} /2	
Input offset current	I _{IO}	—	(1)	100	pA	V _{IN} = V _{DD} /2	
Common mode input voltage range	V _{CM}	-0.1	—	2.1	V		
Supply current	HA1631S01/03	I _{DD}	—	5	10	μA	V _{DD} = 3V, V _{IN+} = 1V, V _{IN-} = 0V
	HA1631S02/04		—	50	100	μA	
Response time	HA1631S01	TP _{LH}	—	(1.20)	—	μs	1V DC bias, 100mV overdrive, C _L = 15pF
	HA1631S01/03	TP _{HL}	—	(0.55)	—	μs	
	HA1631S01	t _r	—	(24)	—	ns	
	HA1631S01/03	t _f	—	(7)	—	ns	
	HA1631S02	TP _{LH}	—	(0.33)	—	μs	
	HA1631S02/04	TP _{HL}	—	(0.17)	—	μs	
	HA1631S02	t _r	—	(12)	—	ns	
Output source current (HA1631S01/02)	I _{OSOURCE}	6	13	—	mA	V _{out} = 2.5V	
		7	14	—	mA	V _{out} = 0.5V	
Common mode rejection ratio	HA1631S01/03	CMRR	60	80	—	dB	V _{IN1} = 0V, V _{IN2} = 2V
	HA1631S02/04		50	70	—	dB	
Power supply rejection ratio	PSRR	60	80	—	dB	V _{DD1} = 1.8V, V _{DD2} = 5.5V	
Output voltage high	V _{OH}	V _{DD} -0.1	—	—	V	R _L = 10kΩ to V _{SS}	
Output voltage low	V _{OL}	—	—	0.1	V	R _L = 10kΩ to V _{DD}	
Output leakage current (Only for HA1631S03/04)	I _{LO}	—	(0.1)	—	nA	V _{IN+} = 1V, V _{IN-} = 0V, V _O = 3V	
Operating voltage range	V _{opr}	1.8	—	5.5	V		

Note: (): Design specification

Table of Graphs

Electrical Characteristics			HA1631S01 Figure	HA1631S02 Figure	HA1631S03 Figure	HA1631S04 Figure	Test Circuit No.
Supply current	I_{DD}	vs. Supply voltage(Out H)	1-1	2-1	3-1	4-1	1
		vs. Supply voltage(Out L)	1-2	2-2	3-2	4-2	2
		vs. Temperature(Out H)	1-3	2-3	3-3	4-3	1
Output high voltage	V_{OH}	vs. Rload	1-18	2-18	3-4	4-4	4
Output source current	$I_{OSOURCE}$	vs. Output high voltage	1-4	2-4	—	—	5
Output low voltage	V_{OL}	vs. Rload	1-17	2-17	3-14	4-14	6
Output sink current	I_{OSINK}	vs. Output low voltage	1-5	2-5	3-4	4-4	5
Input offset voltage	V_{IO}	vs. Supply voltage	1-6	2-6	3-5	4-5	8
		vs. Temperature	1-7	2-7	3-6	4-6	7
Common mode input voltage range	V_{CM}	vs. Temperature	1-8	2-8	3-7	4-7	9
Power supply rejection ratio	PSRR	vs. Supply voltage	1-9	2-9	3-8	4-8	11
Common mode rejection ratio	CMRR	vs. Input voltage	1-10	2-10	3-9	4-9	12
Input bias current	I_{IB}	vs. Temperature	1-11	2-11	3-10	4-10	10
		vs. Input voltage	1-12	2-12	3-11	4-11	10
Falling time	t_f	vs. Temperature	1-13	2-13	3-12	4-12	13
		vs. Cload	1-15	2-15	3-13	4-13	13
		Time waveform	1-20	2-20	3-15	4-15	13
Rising time	t_r	vs. Temperature	1-14	2-14	—	—	13
		vs. Cload	1-16	2-16	—	—	13
		Time waveform	1-19	2-19	—	—	13
Propagation delay time	TP_{LH}	Time waveform	1-21	2-21	—	—	13
	TP_{HL}	Time waveform	1-22	2-22	3-16, 3-17	4-16, 4-17	13

Main Characteristics

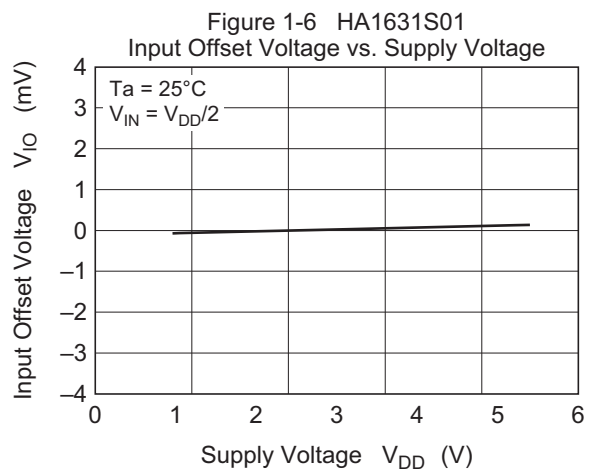
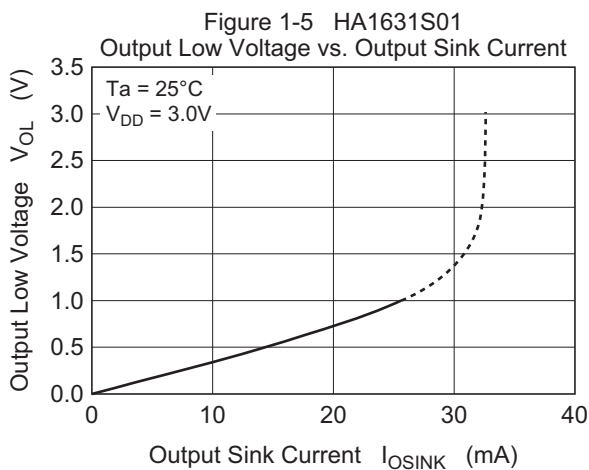
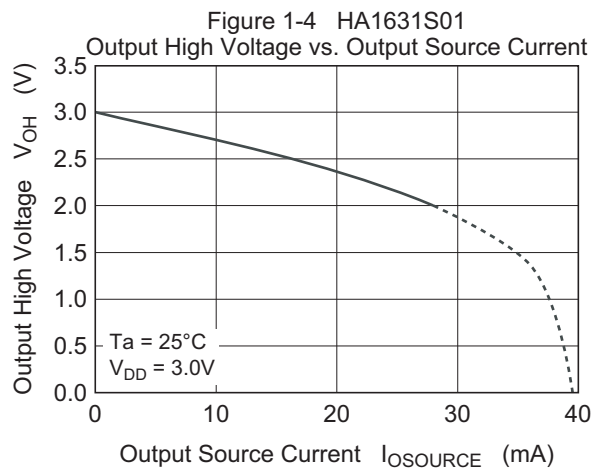
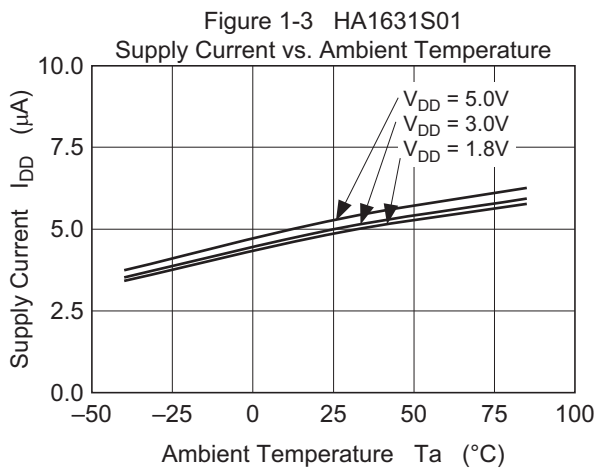
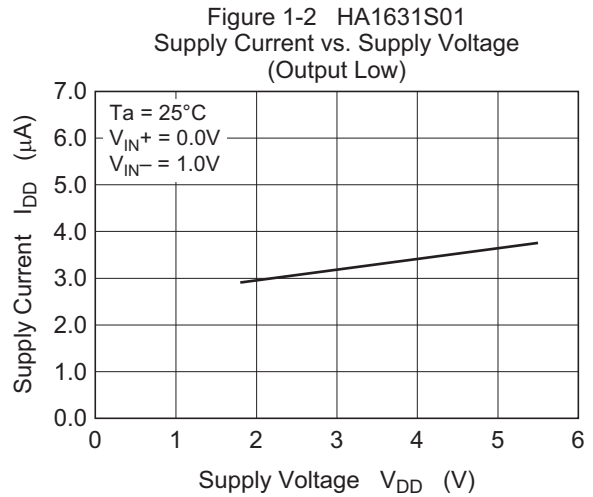
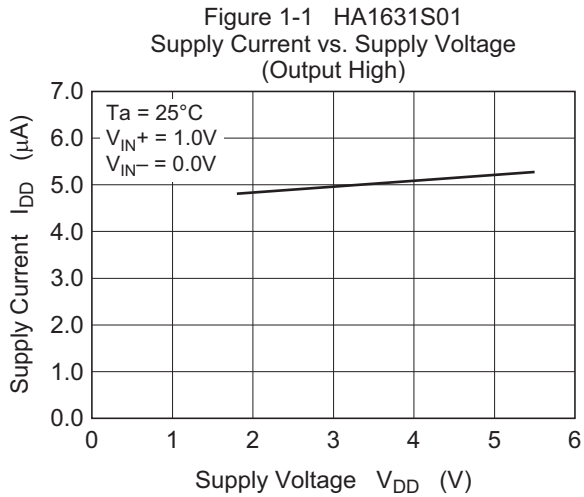

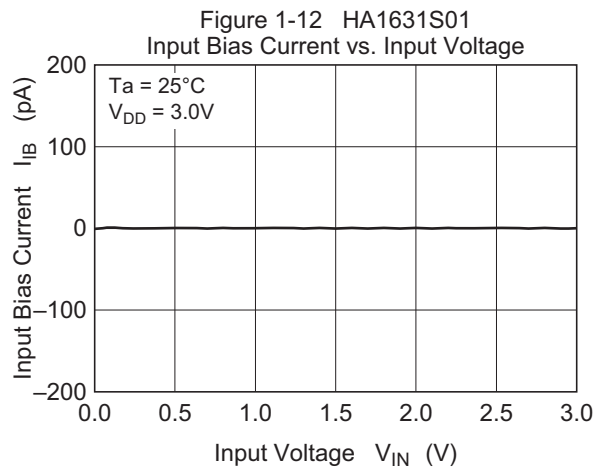
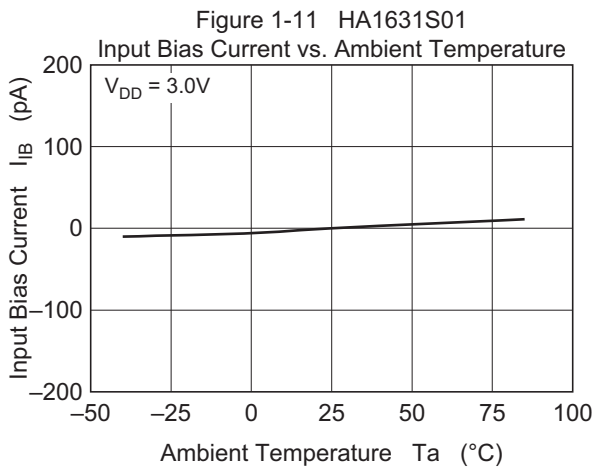
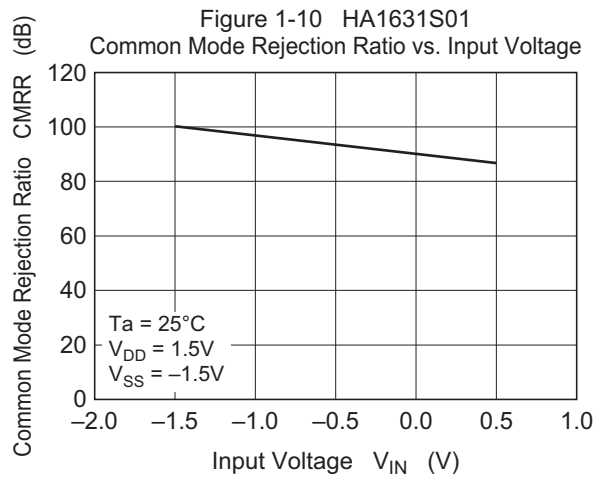
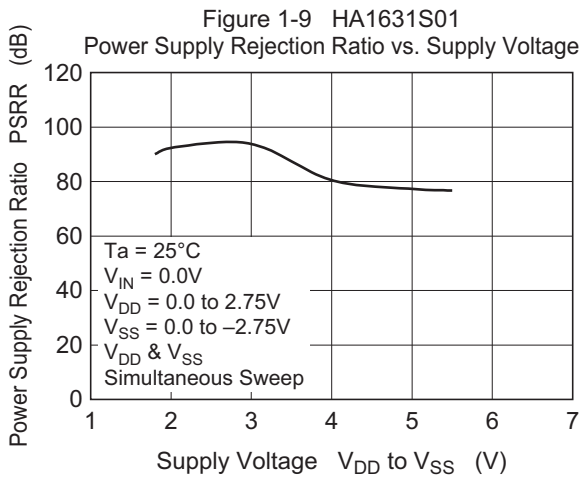
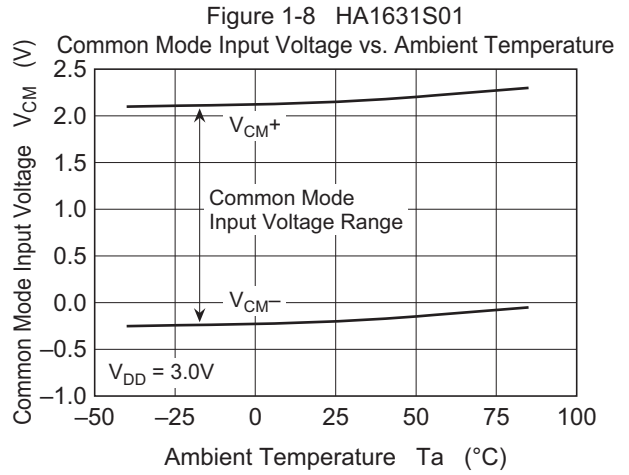
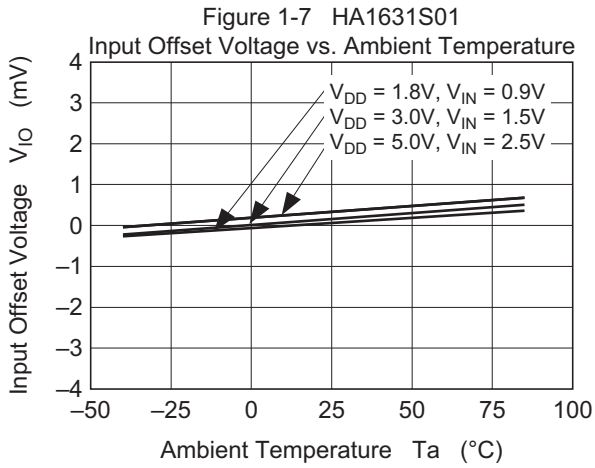

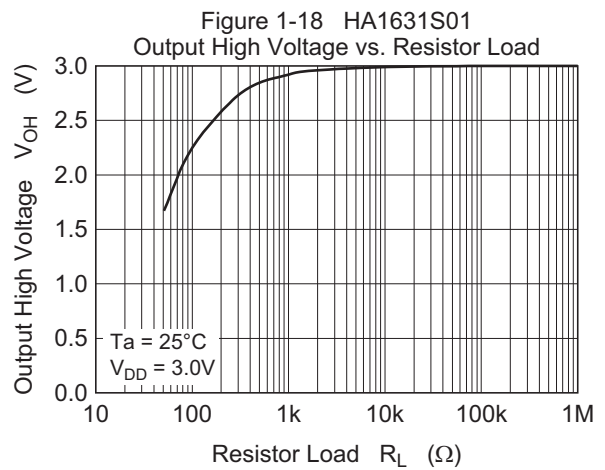
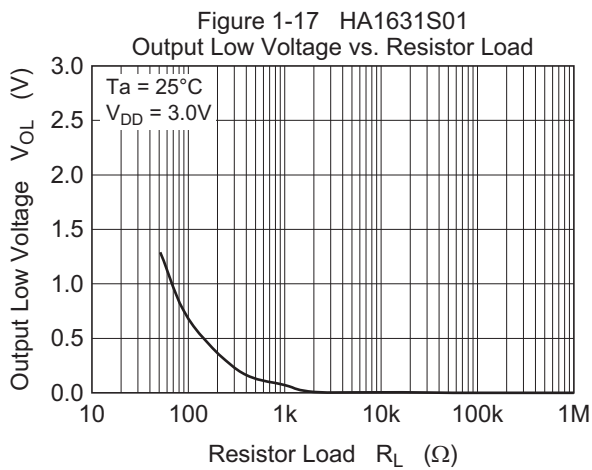
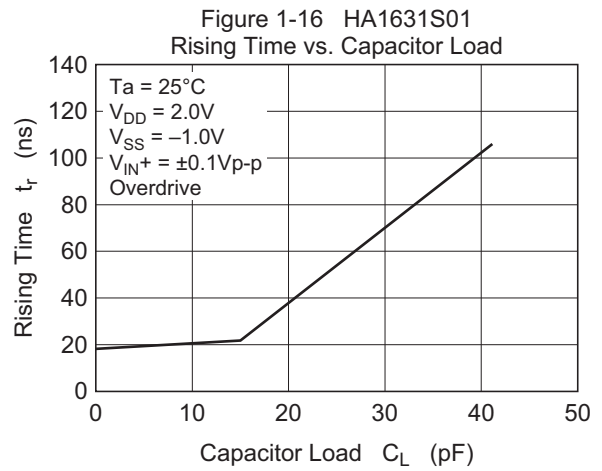
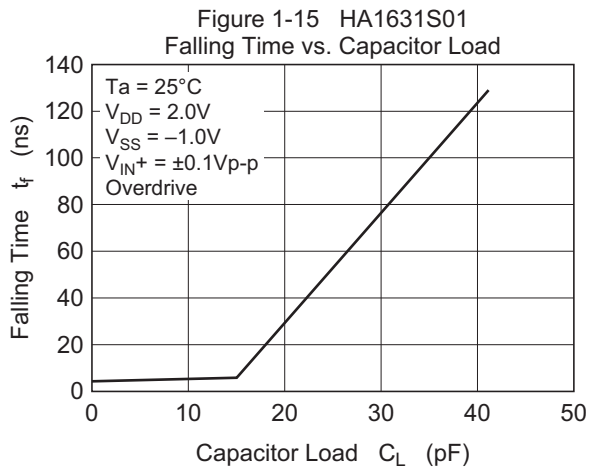
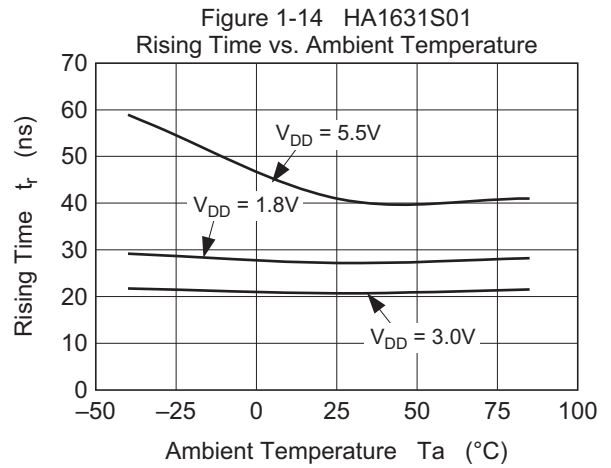
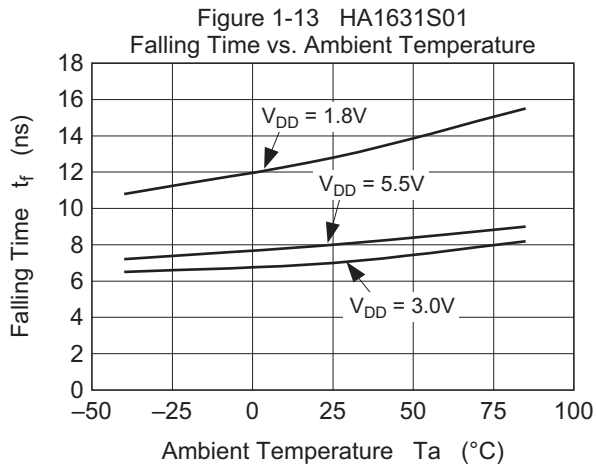

Figure 1-19 HA1631S01
Rising Time, t_r
(Overdrive = $\pm 0.1V_{p-p}$)

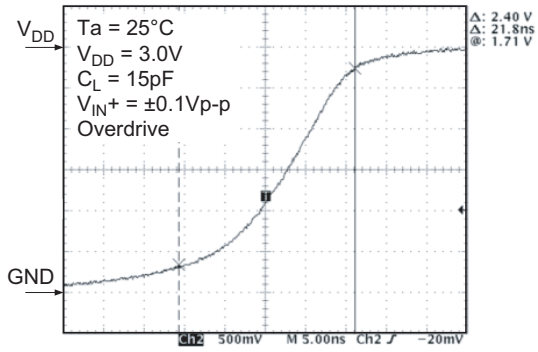

Figure 1-20 HA1631S01
Falling Time, t_f
(Overdrive = $\pm 0.1V_{p-p}$)

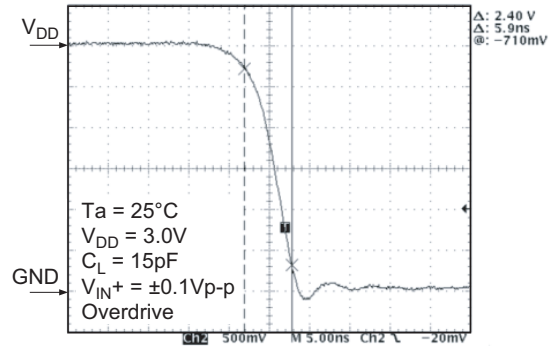

Figure 1-21 HA1631S01
 TP_{LH} Transient Response
(Overdrive = $\pm 0.1V_{p-p}$)

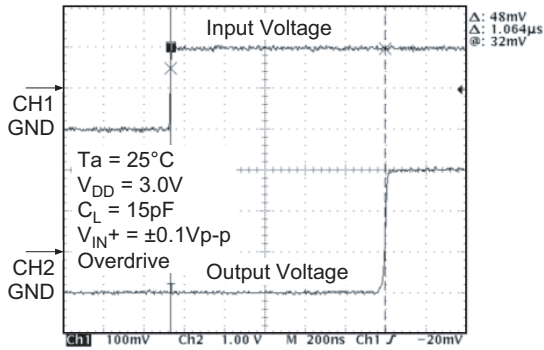

Figure 1-22 HA1631S01
 TP_{HL} Transient Response
(Overdrive = $\pm 0.1V_{p-p}$)

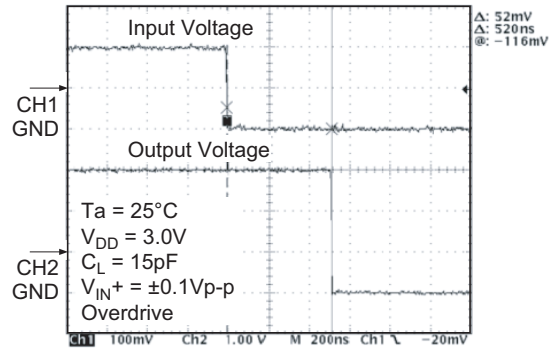

Figure 2-1 HA1631S02
Supply Current vs. Supply Voltage
(Output High)

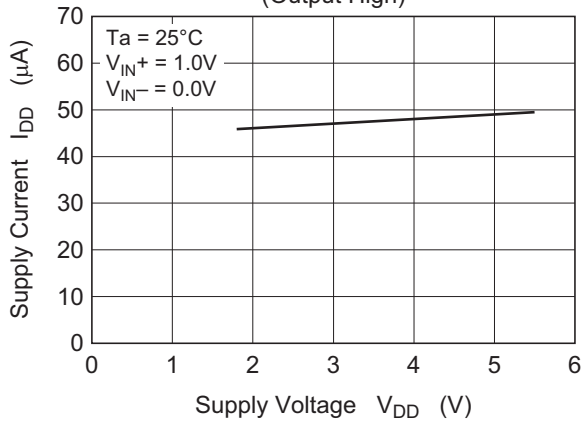

Figure 2-2 HA1631S02
Supply Current vs. Supply Voltage
(Output Low)

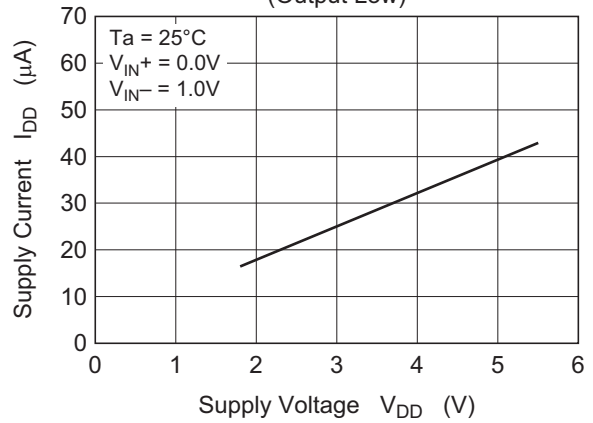

Figure 2-3 HA1631S02
Supply Current vs. Ambient Temperature

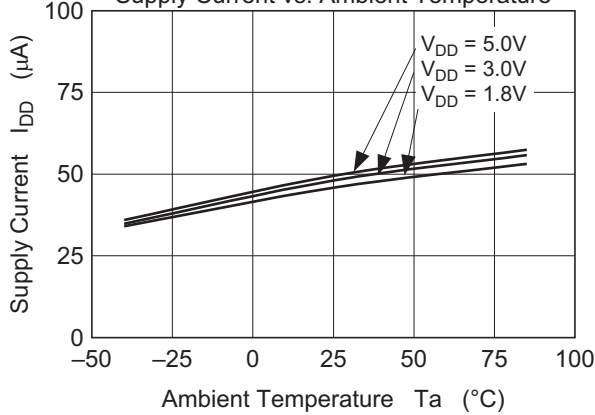

Figure 2-4 HA1631S02
Output High Voltage vs. Output Source Current

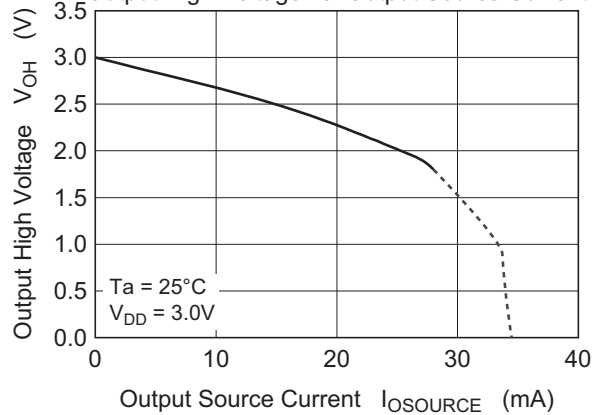

Figure 2-5 HA1631S02
Output Low Voltage vs. Output Sink Current

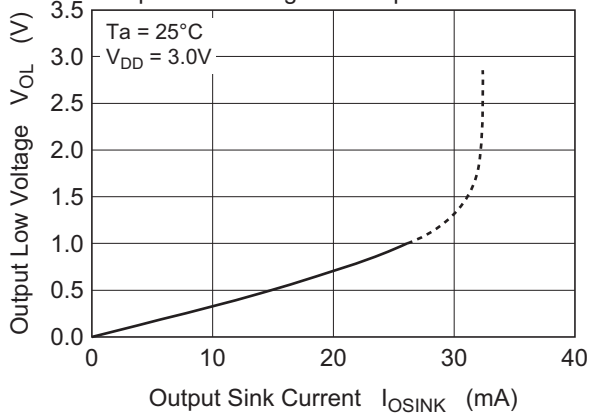

Figure 2-6 HA1631S02
Input Offset Voltage vs. Supply Voltage

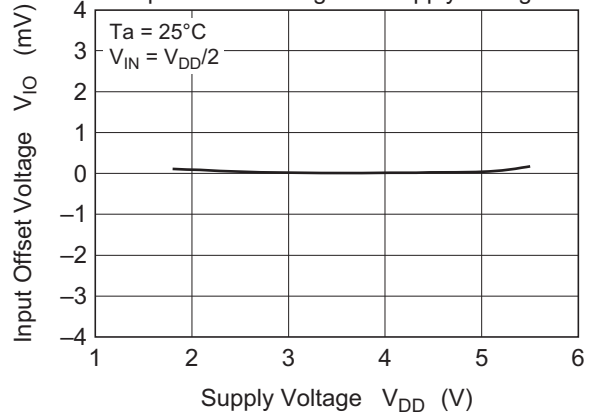

Figure 2-7 HA1631S02

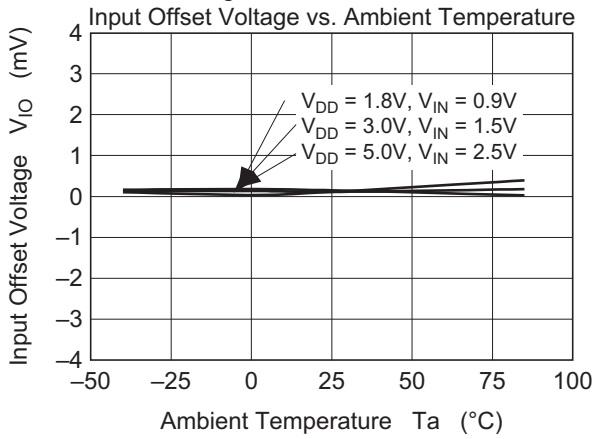

Figure 2-8 HA1631S02

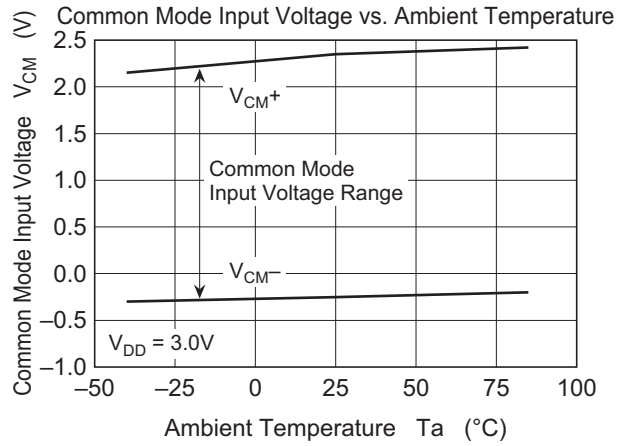

Figure 2-9 HA1631S02

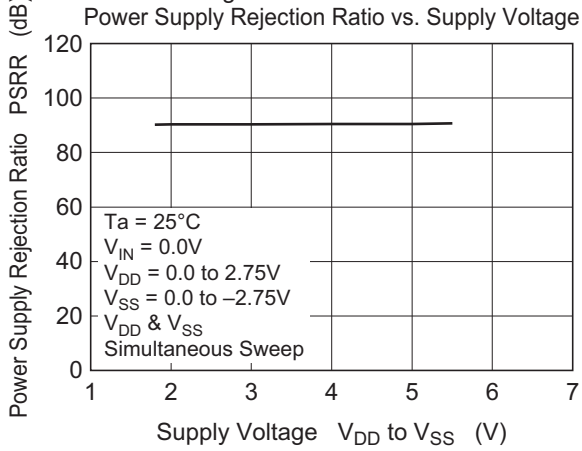

Figure 2-10 HA1631S02

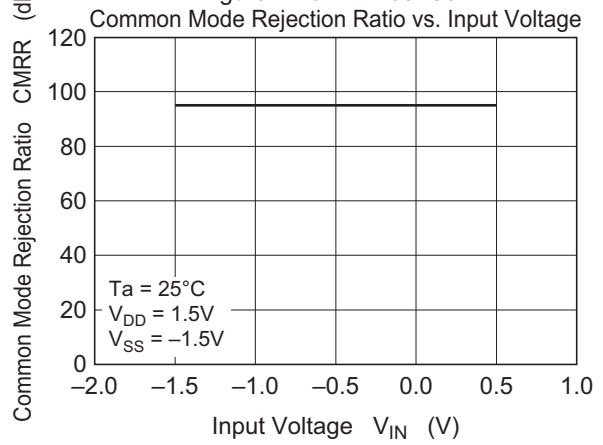

Figure 2-11 HA1631S02

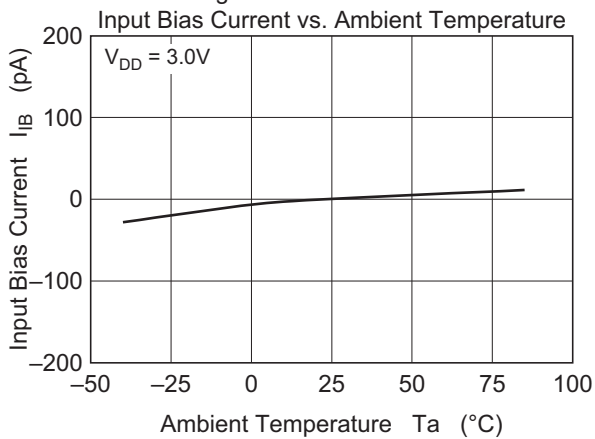
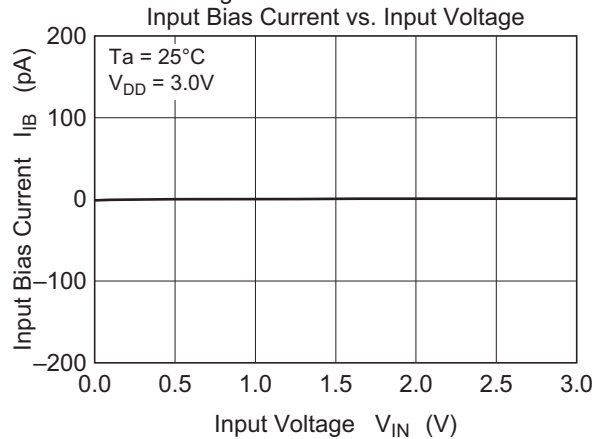

Figure 2-12 HA1631S02



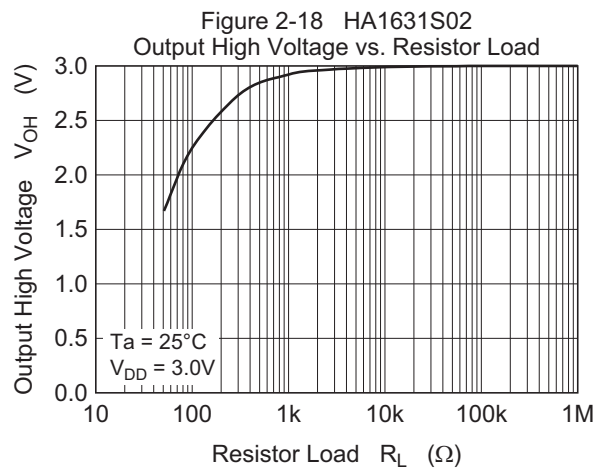
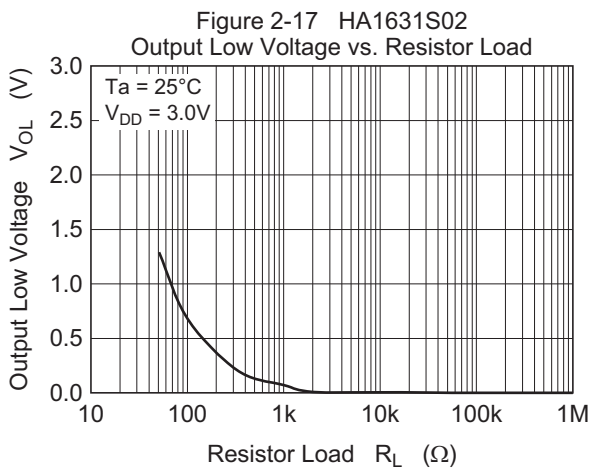
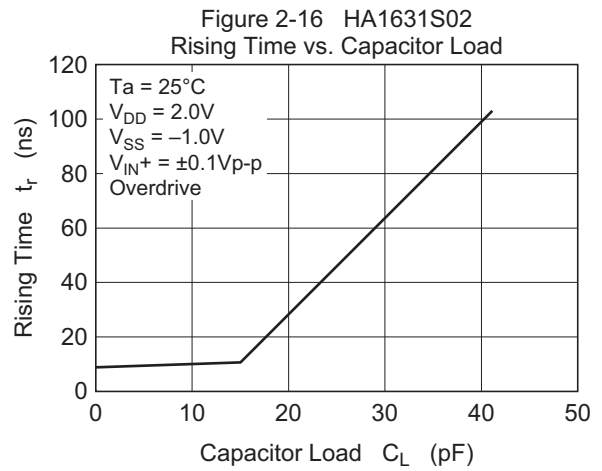
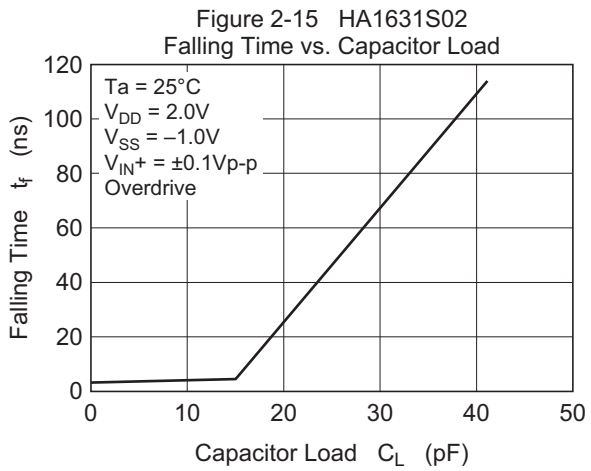
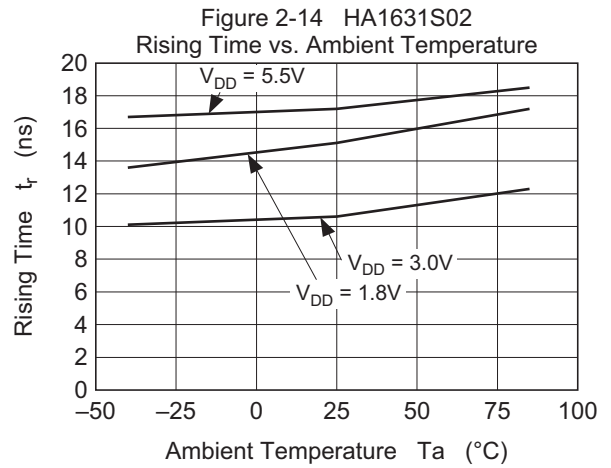
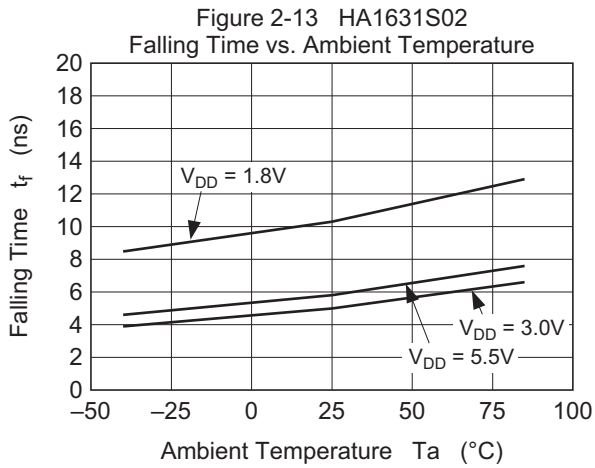

Figure 2-19 HA1631S02
Rising Time, t_r
(Overdrive = $\pm 0.1V_{p-p}$)

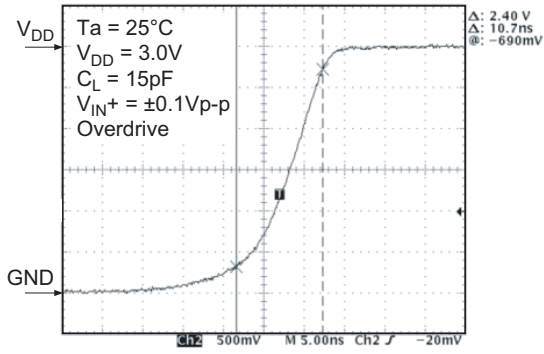

Figure 2-20 HA1631S02
Falling Time, t_f
(Overdrive = $\pm 0.1V_{p-p}$)

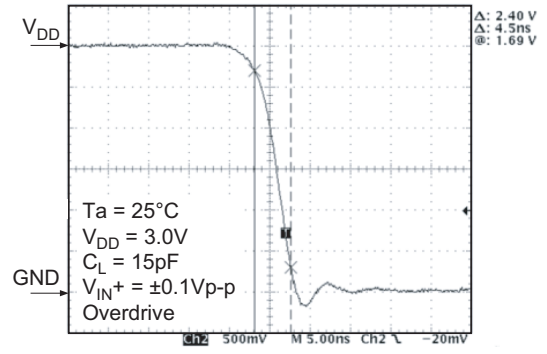

Figure 2-21 HA1631S02
 TP_{LH} Transient Response
(Overdrive = $\pm 0.1V_{p-p}$)

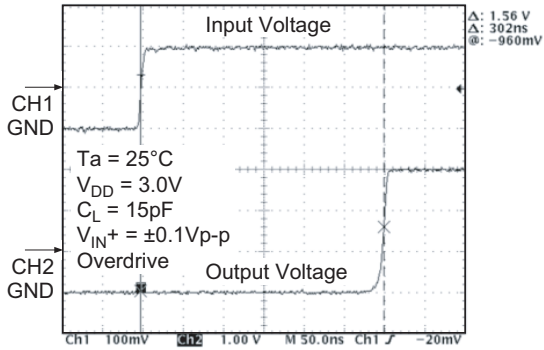

Figure 2-22 HA1631S02
 TP_{HL} Transient Response
(Overdrive = $\pm 0.1V_{p-p}$)

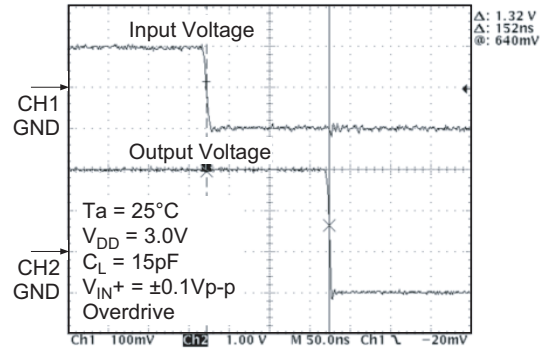

Figure 3-1 HA1631S03
Supply Current vs. Supply Voltage
(Output High)

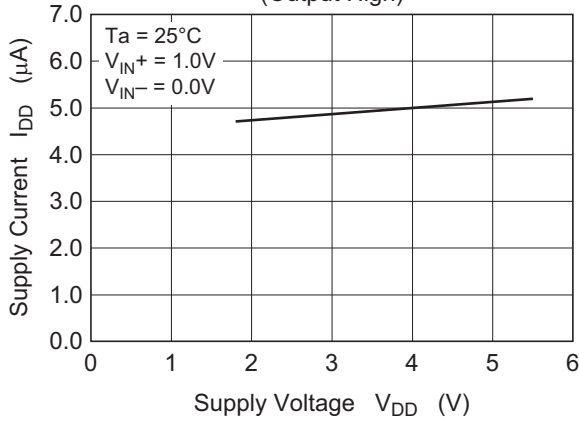

Figure 3-2 HA1631S03
Supply Current vs. Supply Voltage
(Output Low)

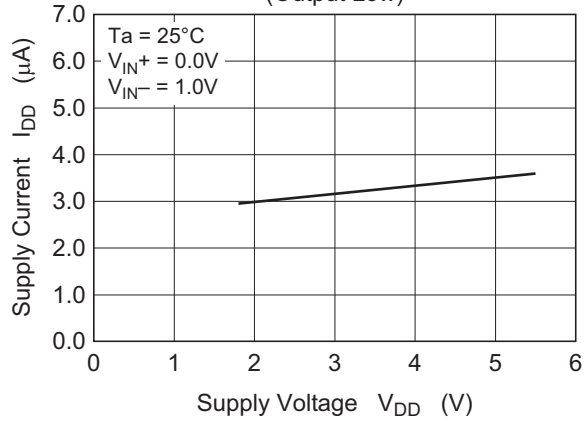

Figure 3-3 HA1631S03
Supply Current vs. Ambient Temperature

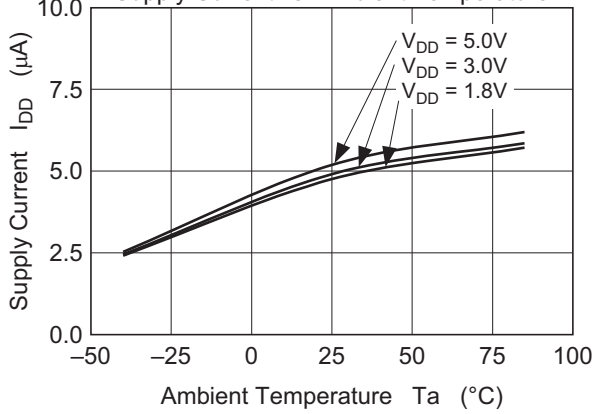

Figure 3-4 HA1631S03
Output Low Voltage vs. Output Sink Current

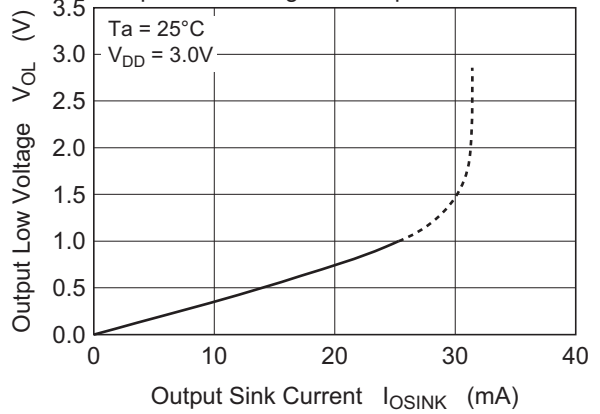

Figure 3-5 HA1631S03
Input Offset Voltage vs. Supply Voltage

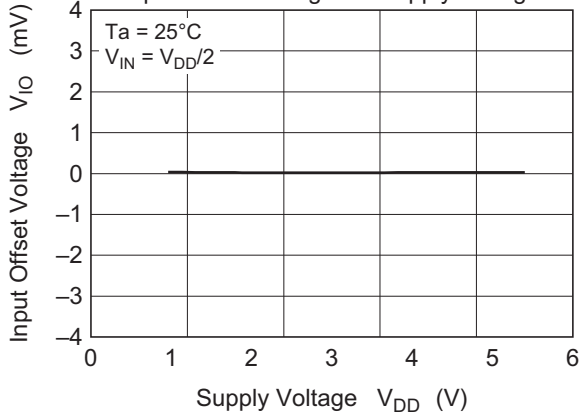
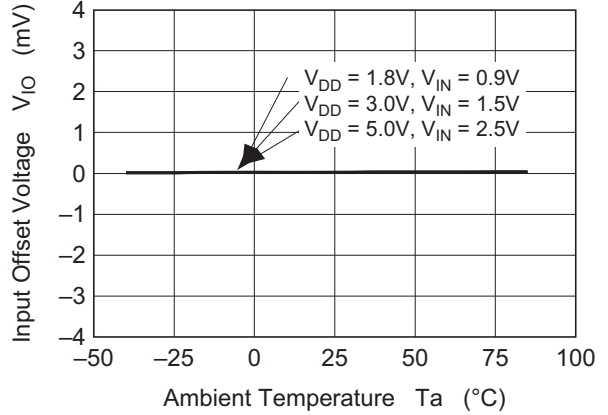
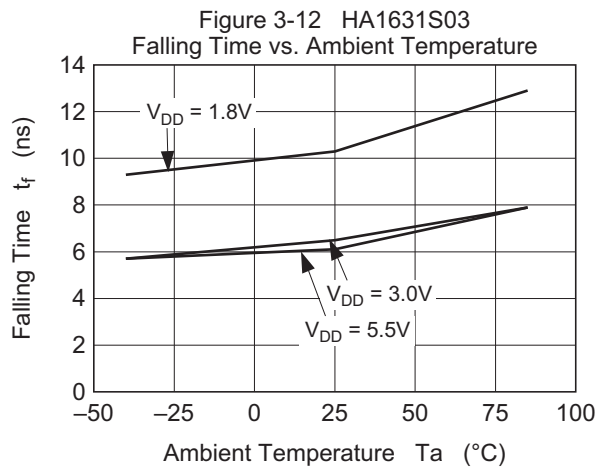
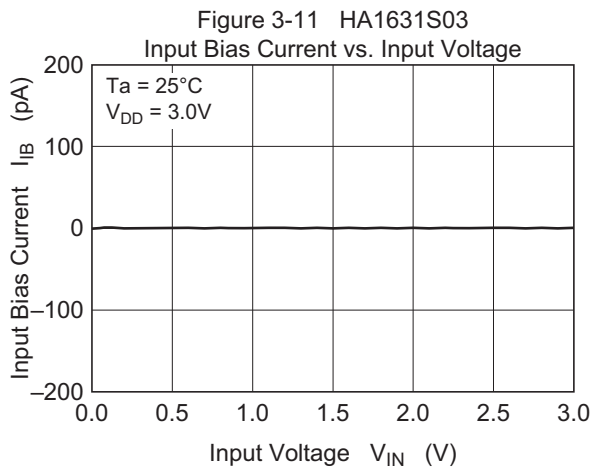
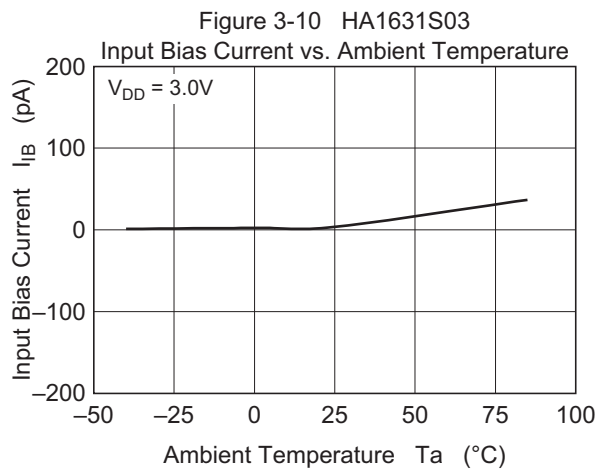
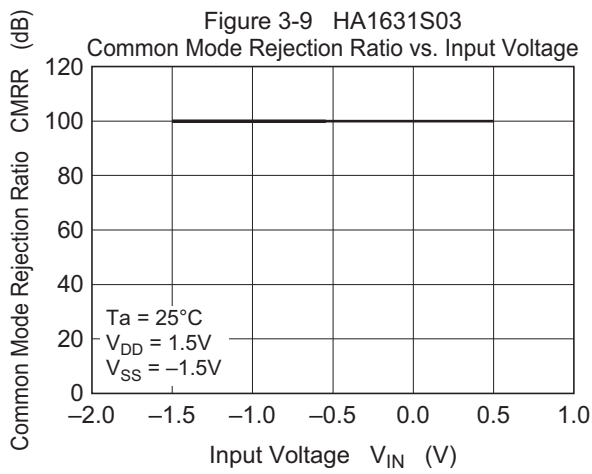
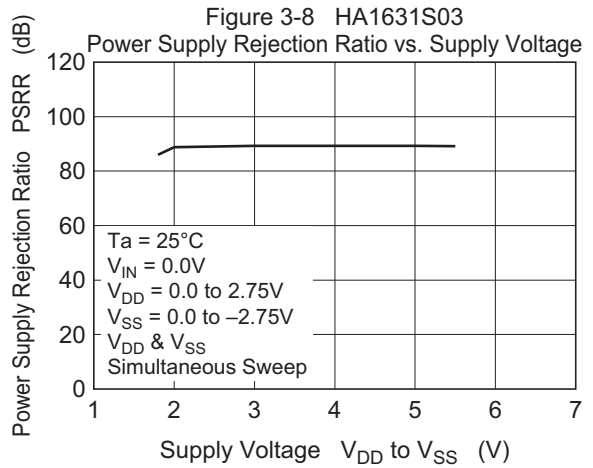
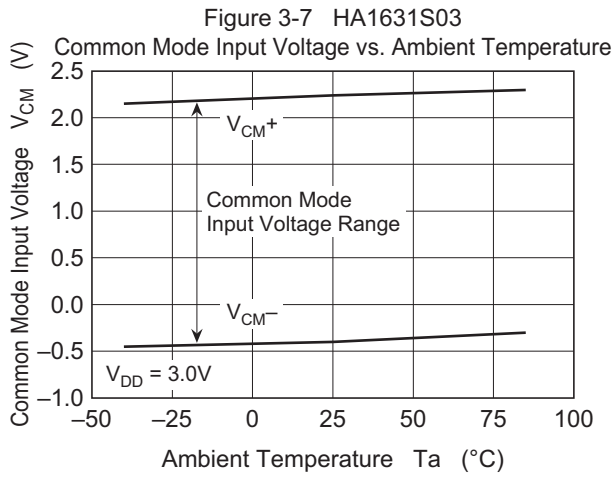

Figure 3-6 HA1631S03
Input Offset Voltage vs. Ambient Temperature





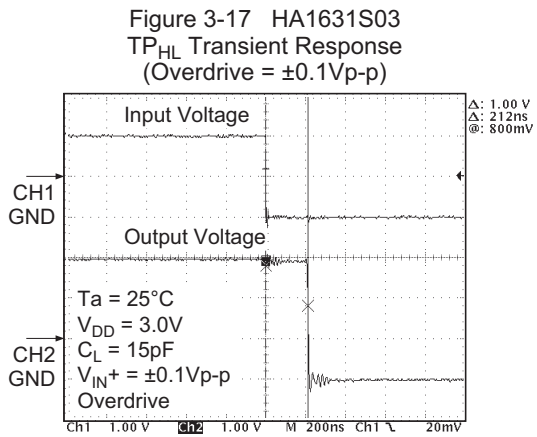
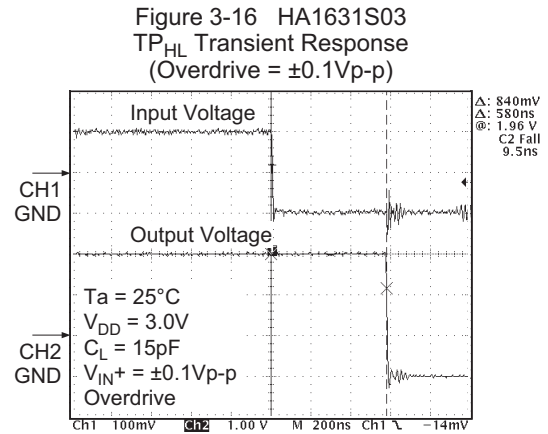
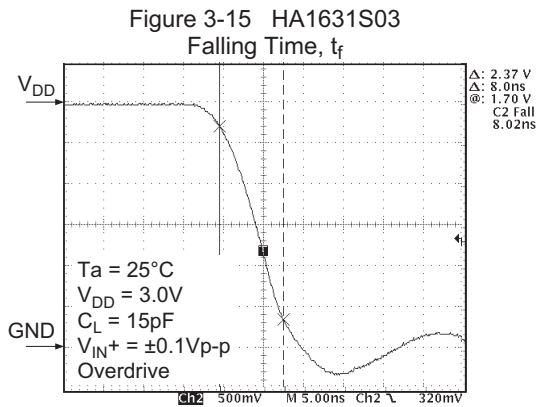
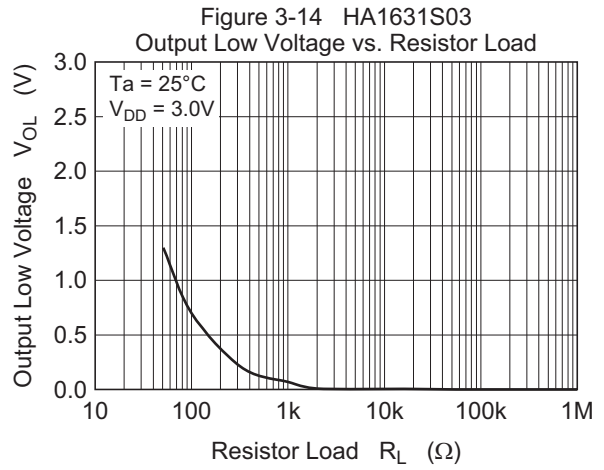
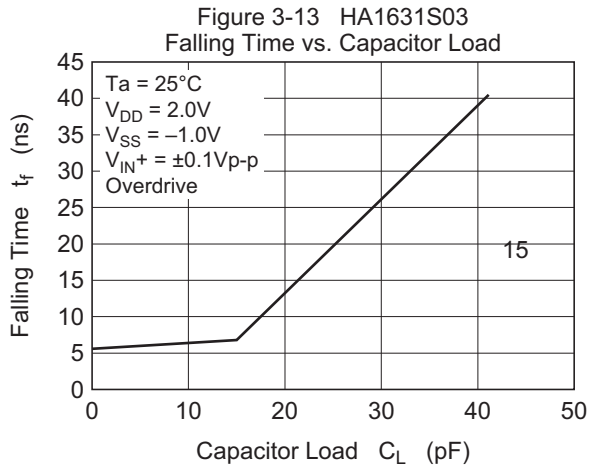

Figure 4-1 HA1631S04
Supply Current vs. Supply Voltage
(Output High)

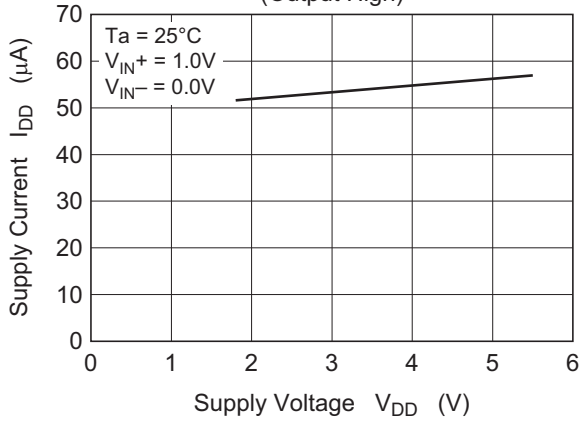

Figure 4-2 HA1631S04
Supply Current vs. Supply Voltage
(Output Low)

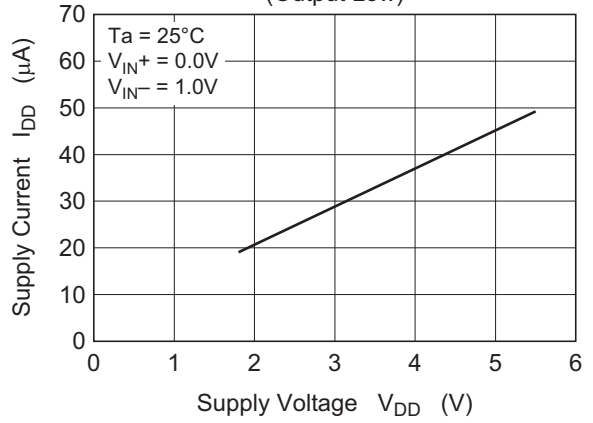

Figure 4-3 HA1631S04
Supply Current vs. Ambient Temperature

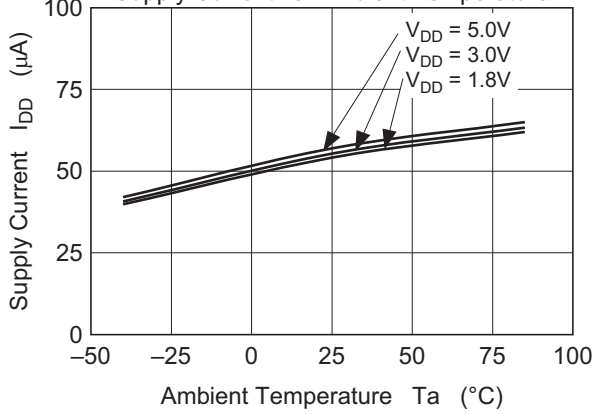

Figure 4-4 HA1631S04
Output Low Voltage vs. Output Sink Current

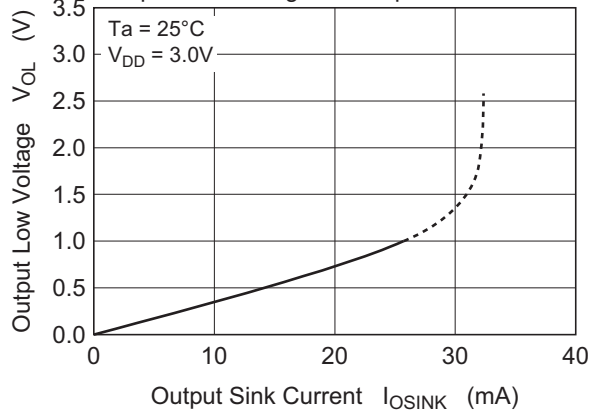

Figure 4-5 HA1631S04
Input Offset Voltage vs. Supply Voltage

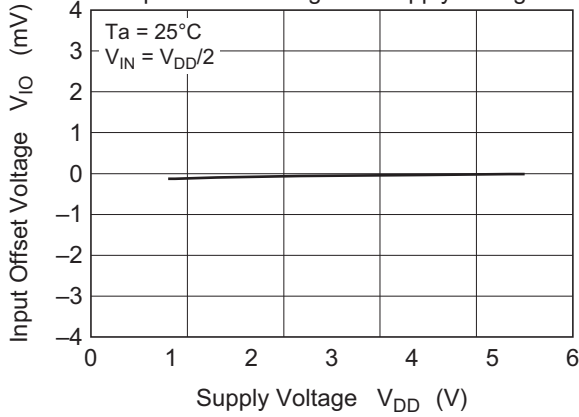
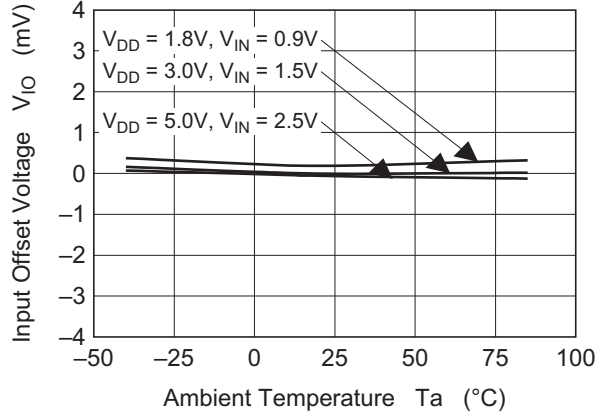
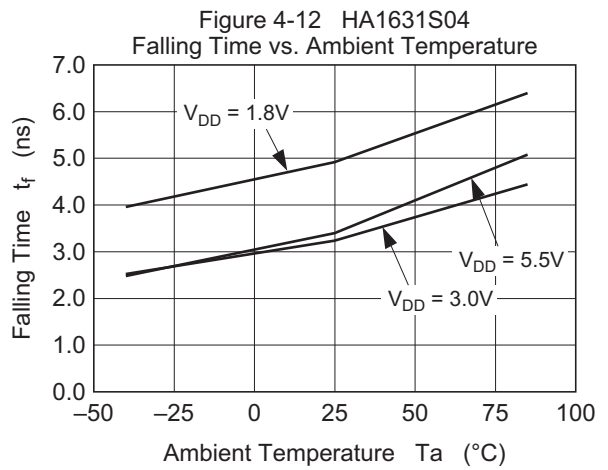
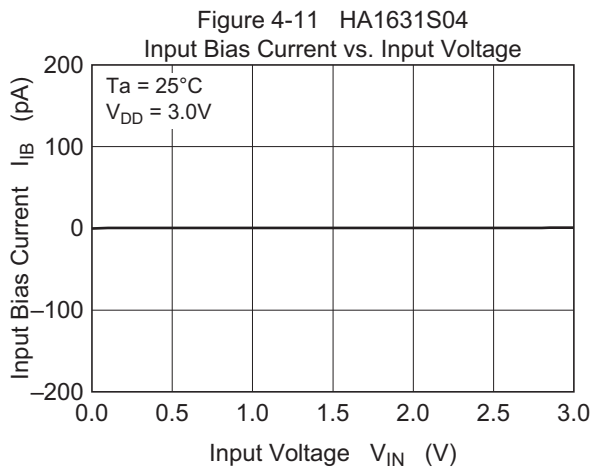
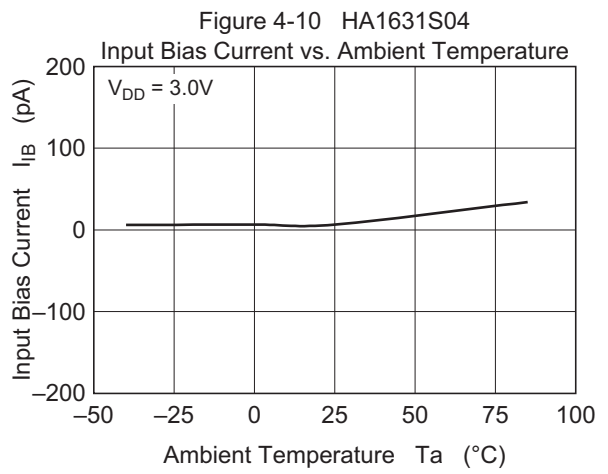
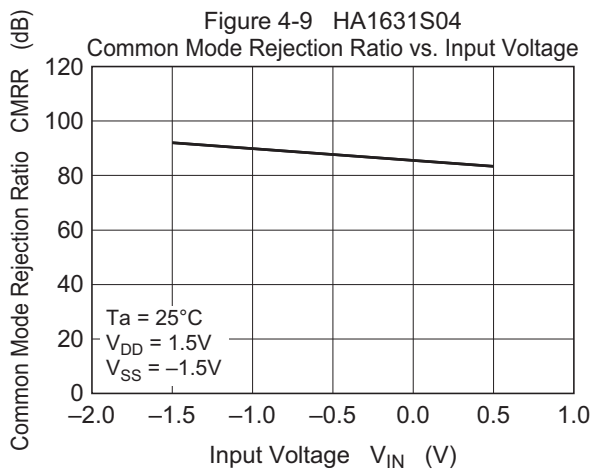
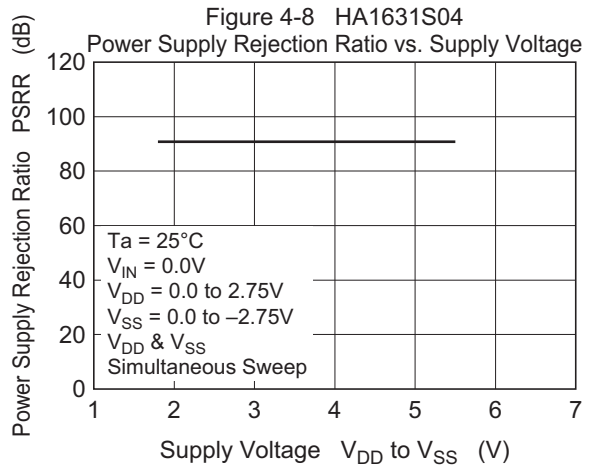
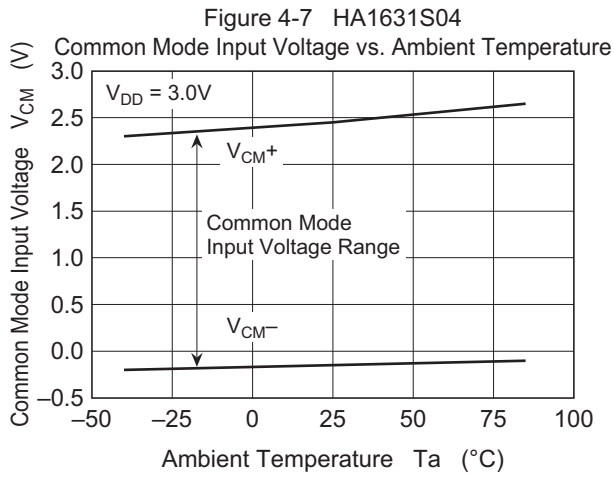
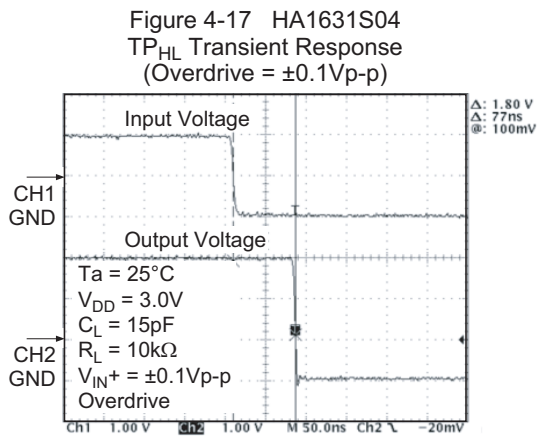
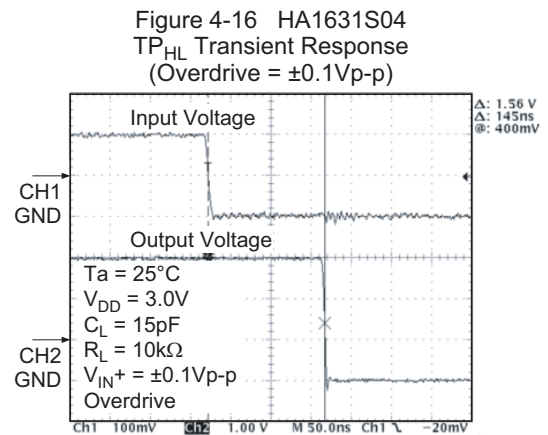
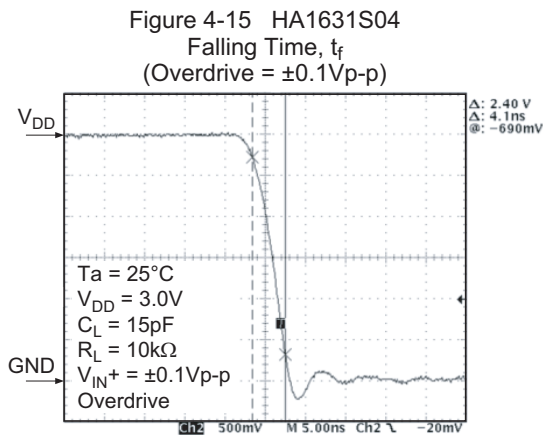
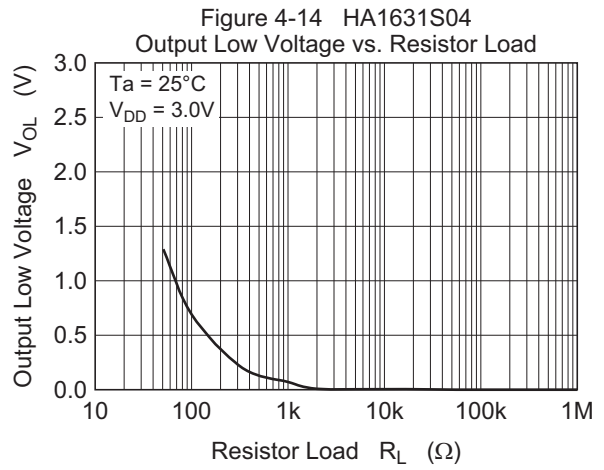
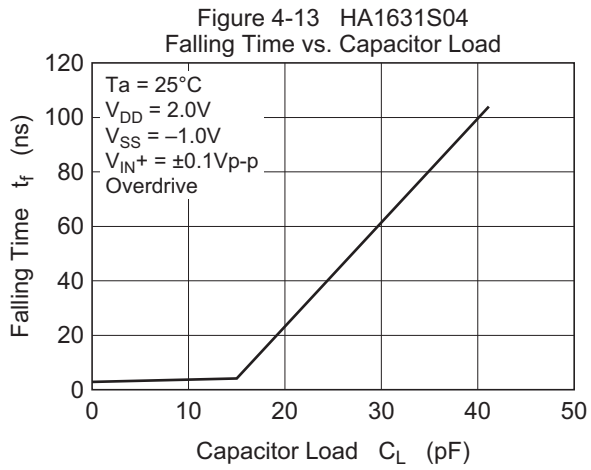

Figure 4-6 HA1631S04
Input Offset Voltage vs. Ambient Temperature







Test Circuits

1. Supply Current, I_{DD} (Output High)

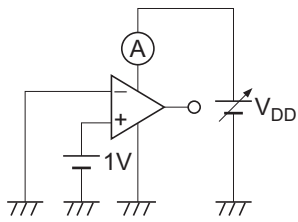

2. Supply Current, I_{DD} (Output Low)

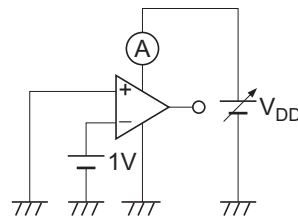

3. Output Source Current, $I_{OSOURCE}$

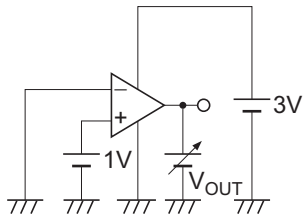

4. Output Voltage High, V_{OH}

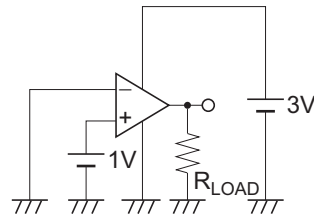

5. Output Sink Current, I_{OSINK}

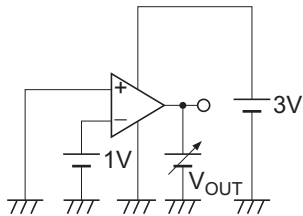

6. Output Voltage Low, V_{OL}

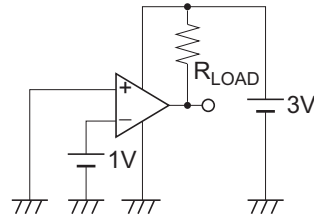

7. Input Offset Voltage, V_{IO}

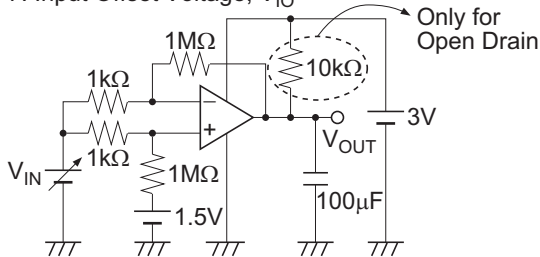

Note: $V_{IO} = V_{OUT} - 1.5V$

8. Input Offset Voltage vs. V_{DD}

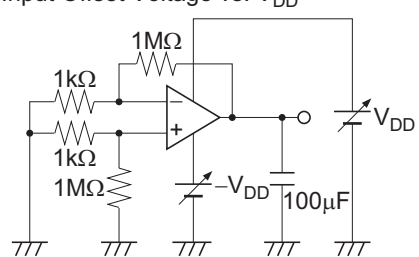

9. Common Mode Input Voltage Range, V_{CM}

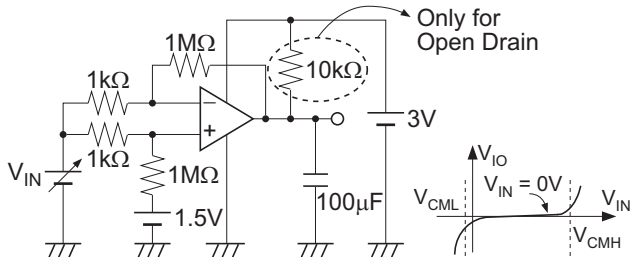

Note: V_{CML} and V_{CMH} are values of V_{IN} when V_{IO} changes more than 50dB taking $V_{IN} = 0V$ as reference.

10. Input Bias Current, I_{IB}

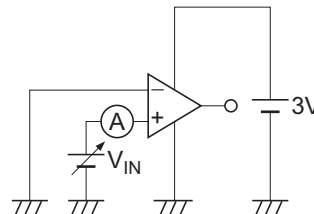

11. Power Supply Rejection Ratio, PSRR

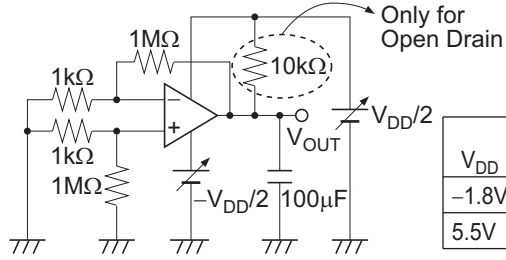

V_{DD}	Measure Point	Calculate V_{IO}	PSRR Calculation
-1.8V	V_{OUT1}	$V_{IO1} = V_{OUT1}/1000$	$PSRR = \left 20 \log_{10} \frac{ (V_{IO2} - V_{IO1}) }{5.5V - 1.8V} \right $
5.5V	V_{OUT2}	$V_{IO2} = V_{OUT2}/1000$	

12. Common Mode Rejection Ratio, CMRR

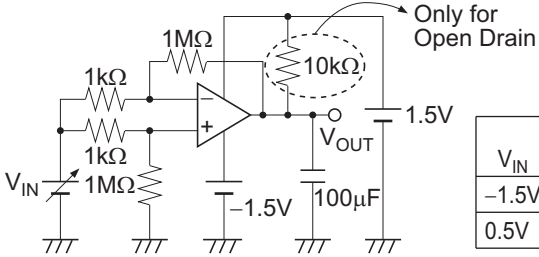

V_{IN}	Measure Point	Calculate V_{IO}	CMRR Calculation
-1.5V	V_{OUT1}	$V_{IO1} = V_{OUT1}/1000$	$CMRR = \left 20 \log_{10} \frac{ (V_{IO2} - V_{IO1}) }{0.5V - (-1.5V)} \right $
0.5V	V_{OUT2}	$V_{IO2} = V_{OUT2}/1000$	

13. Falling Time, Rising Time, Propagation Delay Time TP_{LH} , TP_{HL}

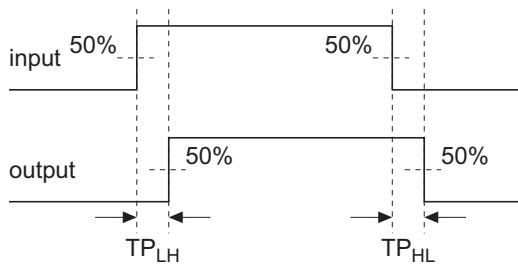
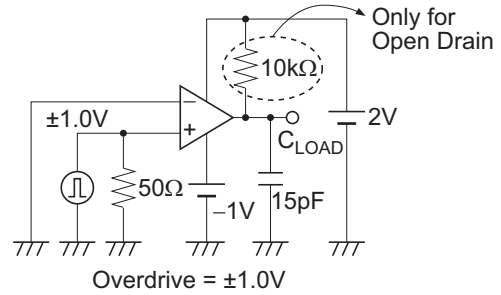
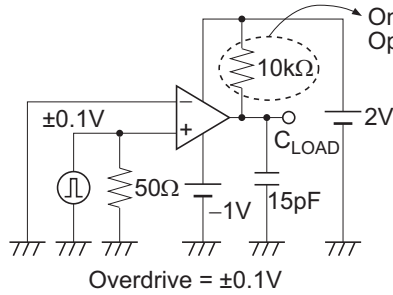

Only for Push Pull HA1631S01/02

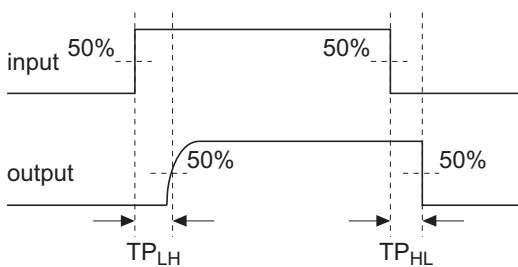
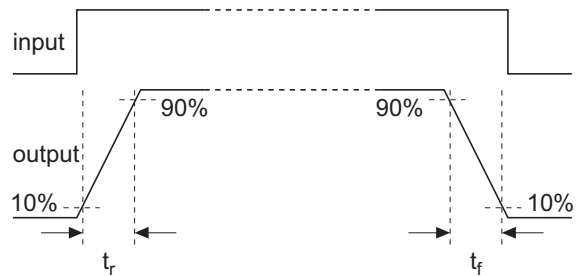

Only for Open Drain HA1631S03/04

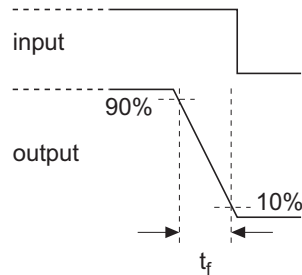

Mark Indication

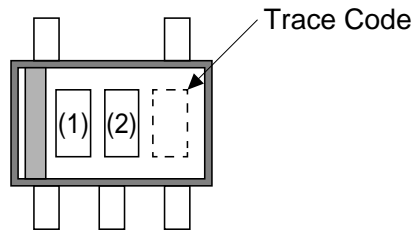

		(1)	(2)
HA1631S01CM	HA1631S01LP	0	A
HA1631S02CM	HA1631S02LP	0	B
HA1631S03CM	HA1631S03LP	0	C
HA1631S04CM	HA1631S04LP	0	D

Package Dimensions

JEITA Package Code	RENESAS Code	Previous Code	MASS (Typ) [g]
SC-88A	PTSP0005ZC-A	CMPAK-5 / CMPAK-5V	0.006

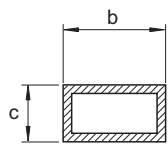
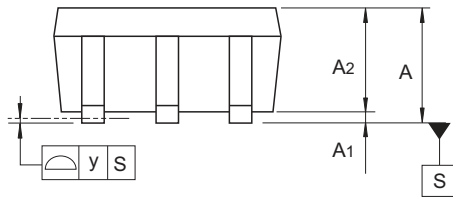
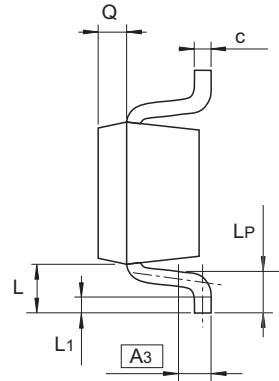
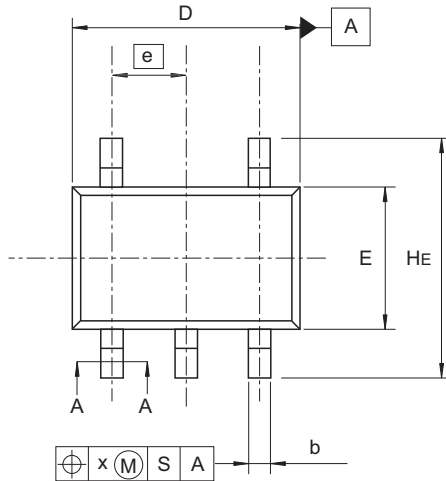

A-A Section

Reference Symbol	Dimensions in millimeters		
	Min	Nom	Max
A	0.8	—	1.1
A ₁	0	—	0.1
A ₂	0.8	0.9	1.0
A ₃	—	0.25	—
b	0.15	0.22	0.3
c	0.1	0.13	0.15
D	1.8	2.0	2.2
E	1.15	1.25	1.35
e	—	0.65	—
HE	1.8	2.1	2.4
L	0.3	—	0.7
L ₁	0.1	—	0.5
LP	0.2	—	0.6
x	—	—	0.05
y	—	—	0.05
Q	—	0.25	—

© 2013 Renesas Electronics Corporation. All rights reserved.

JEITA Package Code	RENESAS Code	Previous Code	MASS (Typ) [g]
SC-74A	PLSP0005ZB-A	MPAK-5 / MPAK-5V	0.015

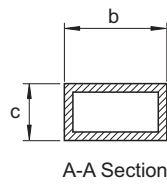
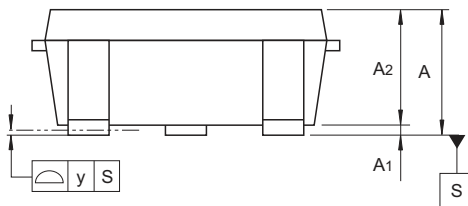
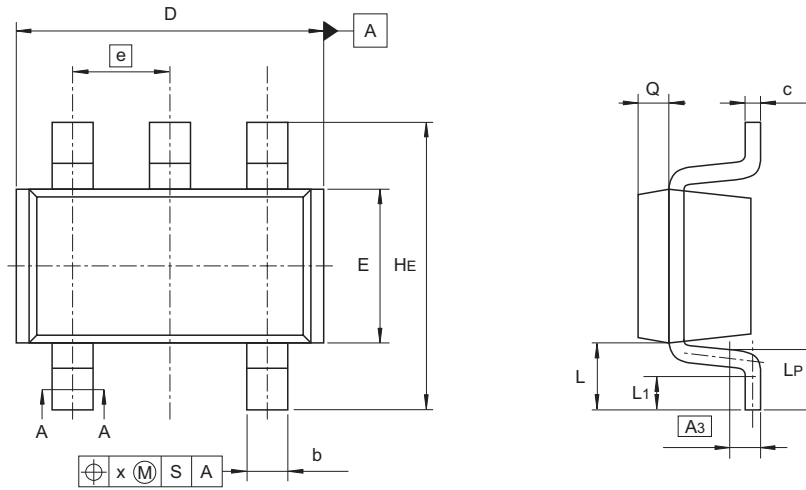

Reference Symbol	Dimensions in millimeters		
	Min	Nom	Max
A	1.0	—	1.4
A ₁	0	—	0.1
A ₂	1.0	1.1	1.3
A ₃	—	0.25	—
b	0.35	0.4	0.5
c	0.11	0.16	0.26
D	2.8	2.95	3.1
E	1.5	1.6	1.8
e	—	0.95	—
HE	2.5	2.8	3.0
L	0.3	—	0.7
L ₁	0.1	—	0.5
LP	0.2	—	0.6
x	—	—	0.05
y	—	—	0.05
Q	—	0.3	—

© 2013 Renesas Electronics Corporation. All rights reserved.

Notice

1. Descriptions of circuits, software and other related information in this document are provided only to illustrate the operation of semiconductor products and application examples. You are fully responsible for the incorporation of these circuits, software, and information in the design of your equipment. Renesas Electronics assumes no responsibility for any losses incurred by you or third parties arising from the use of these circuits, software, or information.
2. Renesas Electronics has used reasonable care in preparing the information included in this document, but Renesas Electronics does not warrant that such information is error free. Renesas Electronics assumes no liability whatsoever for any damages incurred by you resulting from errors in or omissions from the information included herein.
3. Renesas Electronics does not assume any liability for infringement of patents, copyrights, or other intellectual property rights of third parties by or arising from the use of Renesas Electronics products or technical information described in this document. No license, express, implied or otherwise, is granted hereby under any patents, copyrights or other intellectual property rights of Renesas Electronics or others.
4. You should not alter, modify, copy, or otherwise misappropriate any Renesas Electronics product, whether in whole or in part. Renesas Electronics assumes no responsibility for any losses incurred by you or third parties arising from such alteration, modification, copy or otherwise misappropriation of Renesas Electronics product.
5. Renesas Electronics products are classified according to the following two quality grades: "Standard" and "High Quality". The recommended applications for each Renesas Electronics product depends on the product's quality grade, as indicated below.
"Standard": Computers; office equipment; communications equipment; test and measurement equipment; audio and visual equipment; home electronic appliances; machine tools; personal electronic equipment; and industrial robots etc.
"High Quality": Transportation equipment (automobiles, trains, ships, etc.); traffic control systems; anti-disaster systems; anti-crime systems; and safety equipment etc.
Renesas Electronics products are neither intended nor authorized for use in products or systems that may pose a direct threat to human life or bodily injury (artificial life support devices or systems, surgical implantations etc.), or may cause serious property damages (nuclear reactor control systems, military equipment etc.). You must check the quality grade of each Renesas Electronics product before using it in a particular application. You may not use any Renesas Electronics product for any application for which it is not intended. Renesas Electronics shall not be in any way liable for any damages or losses incurred by you or third parties arising from the use of any Renesas Electronics product for which the product is not intended by Renesas Electronics.
6. You should use the Renesas Electronics products described in this document within the range specified by Renesas Electronics, especially with respect to the maximum rating, operating supply voltage range, movement power voltage range, heat radiation characteristics, installation and other product characteristics. Renesas Electronics shall have no liability for malfunctions or damages arising out of the use of Renesas Electronics products beyond such specified ranges.
7. Although Renesas Electronics endeavors to improve the quality and reliability of its products, semiconductor products have specific characteristics such as the occurrence of failure at a certain rate and malfunctions under certain use conditions. Further, Renesas Electronics products are not subject to radiation resistance design. Please be sure to implement safety measures to guard them against the possibility of physical injury, and injury or damage caused by fire in the event of the failure of a Renesas Electronics product, such as safety design for hardware and software including but not limited to redundancy, fire control and malfunction prevention, appropriate treatment for aging degradation or any other appropriate measures. Because the evaluation of microcomputer software alone is very difficult, please evaluate the safety of the final products or systems manufactured by you.
8. Please contact a Renesas Electronics sales office for details as to environmental matters such as the environmental compatibility of each Renesas Electronics product. Please use Renesas Electronics products in compliance with all applicable laws and regulations that regulate the inclusion or use of controlled substances, including without limitation, the EU RoHS Directive. Renesas Electronics assumes no liability for damages or losses occurring as a result of your noncompliance with applicable laws and regulations.
9. Renesas Electronics products and technology may not be used for or incorporated into any products or systems whose manufacture, use, or sale is prohibited under any applicable domestic or foreign laws or regulations. You should not use Renesas Electronics products or technology described in this document for any purpose relating to military applications or use by the military, including but not limited to the development of weapons of mass destruction. When exporting the Renesas Electronics products or technology described in this document, you should comply with the applicable export control laws and regulations and follow the procedures required by such laws and regulations.
10. It is the responsibility of the buyer or distributor of Renesas Electronics products, who distributes, disposes of, or otherwise places the product with a third party, to notify such third party in advance of the contents and conditions set forth in this document, Renesas Electronics assumes no responsibility for any losses incurred by you or third parties as a result of unauthorized use of Renesas Electronics products.
11. This document may not be reproduced or duplicated in any form, in whole or in part, without prior written consent of Renesas Electronics.
12. Please contact a Renesas Electronics sales office if you have any questions regarding the information contained in this document or Renesas Electronics products, or if you have any other inquiries.

(Note 1) "Renesas Electronics" as used in this document means Renesas Electronics Corporation and also includes its majority-owned subsidiaries.

(Note 2) "Renesas Electronics product(s)" means any product developed or manufactured by or for Renesas Electronics.



SALES OFFICES

Renesas Electronics Corporation

<http://www.renesas.com>

Refer to "<http://www.renesas.com/>" for the latest and detailed information.

Renesas Electronics America Inc.
2801 Scott Boulevard Santa Clara, CA 95050-2549, U.S.A.
Tel: +1-408-588-6000, Fax: +1-408-588-6130

Renesas Electronics Canada Limited
9251 Yonge Street, Suite 8309 Richmond Hill, Ontario Canada L4C 9T3
Tel: +1-905-237-2004

Renesas Electronics Europe Limited
Dukes Meadow, Millboard Road, Bourne End, Buckinghamshire, SL8 5FH, U.K
Tel: +44-1628-585-100, Fax: +44-1628-585-900

Renesas Electronics Europe GmbH
Arcadiastrasse 10, 40472 Düsseldorf, Germany
Tel: +49-211-6503-0, Fax: +49-211-6503-1327

Renesas Electronics (China) Co., Ltd.
Room 1709, Quantum Plaza, No.27 ZhichunLu Haidian District, Beijing 100191, P.R.China
Tel: +86-10-8235-1155, Fax: +86-10-8235-7679

Renesas Electronics (Shanghai) Co., Ltd.
Unit 301, Tower A, Central Towers, 555 Langao Road, Putuo District, Shanghai, P. R. China 200333
Tel: +86-21-2226-0888, Fax: +86-21-2226-0899

Renesas Electronics Hong Kong Limited
Unit 1601-1611, 16/F., Tower 2, Grand Century Place, 193 Prince Edward Road West, Mongkok, Kowloon, Hong Kong
Tel: +852-2265-8688, Fax: +852-2886-9022

Renesas Electronics Taiwan Co., Ltd.
13F, No. 363, Fu Shing North Road, Taipei 10543, Taiwan
Tel: +886-2-8175-9600, Fax: +886-2-8175-9670

Renesas Electronics Singapore Pte. Ltd.
80 Bendemeer Road, Unit #06-02 Hyflux Innovation Centre, Singapore 339949
Tel: +65-6213-0200, Fax: +65-6213-0300

Renesas Electronics Malaysia Sdn.Bhd.
Unit 1207, Block B, Menara Amcorp, Amcorp Trade Centre, No. 18, Jln Persiaran Barat, 46050 Petaling Jaya, Selangor Darul Ehsan, Malaysia
Tel: +60-3-7955-9390, Fax: +60-3-7955-9510

Renesas Electronics India Pvt. Ltd.
No.777C, 100 Feet Road, HAL II Stage, Indiranagar, Bangalore, India
Tel: +91-80-67208700, Fax: +91-80-67208777

Renesas Electronics Korea Co., Ltd.
12F., 234 Teheran-ro, Gangnam-Gu, Seoul, 135-080, Korea
Tel: +82-2-558-3737, Fax: +82-2-558-5141

Mouser Electronics

Authorized Distributor

Click to View Pricing, Inventory, Delivery & Lifecycle Information:

[Renesas Electronics:](#)

[HA1631S03CMEL-E](#) [HA1631S04CMEL-E](#) [HA1631S02CMEL-E](#) [HA1631S01CMEL-E](#)



Стандарт Электрон Связь

Мы молодая и активно развивающаяся компания в области поставок электронных компонентов. Мы поставляем электронные компоненты отечественного и импортного производства напрямую от производителей и с крупнейших складов мира.

Благодаря сотрудничеству с мировыми поставщиками мы осуществляем комплексные и плановые поставки широчайшего спектра электронных компонентов.

Собственная эффективная логистика и склад в обеспечивает надежную поставку продукции в точно указанные сроки по всей России.

Мы осуществляем техническую поддержку нашим клиентам и предпродажную проверку качества продукции. На все поставляемые продукты мы предоставляем гарантию .

Осуществляем поставки продукции под контролем ВП МО РФ на предприятия военно-промышленного комплекса России , а также работаем в рамках 275 ФЗ с открытием отдельных счетов в уполномоченном банке. Система менеджмента качества компании соответствует требованиям ГОСТ ISO 9001.

Минимальные сроки поставки, гибкие цены, неограниченный ассортимент и индивидуальный подход к клиентам являются основой для выстраивания долгосрочного и эффективного сотрудничества с предприятиями радиоэлектронной промышленности, предприятиями ВПК и научно-исследовательскими институтами России.

С нами вы становитесь еще успешнее!

Наши контакты:

Телефон: +7 812 627 14 35

Электронная почта: sales@st-electron.ru

Адрес: 198099, Санкт-Петербург,
Промышленная ул, дом № 19, литера Н,
помещение 100-Н Офис 331