

## Product Summary

Device	BV <sub>DS</sub>	R <sub>DS(ON)</sub> MAX	I <sub>D</sub> MAX T <sub>A</sub> = +25°C
Q1 N-Channel	12V	34mΩ @ V <sub>GS</sub> = 4.5V	5.1A
		40mΩ @ V <sub>GS</sub> = 2.5V	4.7A
		50mΩ @ V <sub>GS</sub> = 1.8V	4.2A
		70mΩ @ V <sub>GS</sub> = 1.5V	3.6A
Q2 P-Channel	-12	59mΩ @ V <sub>GS</sub> = -4.5V	-3.9A
		81mΩ @ V <sub>GS</sub> = -2.5V	-3.3A
		115mΩ @ V <sub>GS</sub> = -1.8V	-2.8A
		215mΩ @ V <sub>GS</sub> = -1.5V	-2.0A

## Description and Applications

This MOSFET is designed to meet the stringent requirements of Automotive applications. It is qualified to AEC-Q101, supported by a PPAP and is ideal for use in:

- Load Switch
- Power Management Functions
- Portable Power Adaptors



ESD PROTECTED

U-DFN2020-6 (Type B)

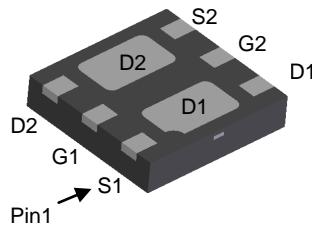

Bottom View

## Features

- Low On-Resistance
- Low Input Capacitance
- Low Profile, 0.6mm Max Height
- **ESD Protected Gate**
- **Totally Lead-Free & Fully RoHS Compliant (Notes 1 & 2)**
- **Halogen and Antimony Free. "Green" Device (Note 3)**
- **Qualified to AEC-Q101 Standards for High Reliability**
- **PPAP Capable (Note 4)**

## Mechanical Data

- Case: U-DFN2020-6 (Type B)
- Case Material: Molded Plastic, "Green" Molding Compound. UL Flammability Classification Rating 94V-0
- Moisture Sensitivity: Level 1 per J-STD-020
- Terminals: Finish NiPdAu over Copper Leadframe. Solderable per MIL-STD-202, Method 208 (e4)
- Terminals Connections: See Diagram Below
- Weight: 0.0065 grams (Approximate)

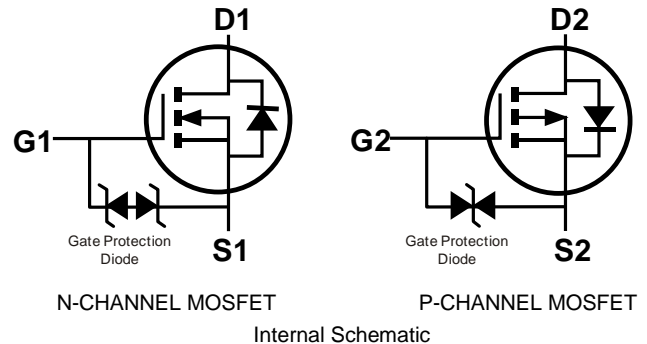

## Ordering Information (Note 5)

Part Number	Case	Packaging
DMC1030UFDBQ-7	U-DFN2020-6 (Type B)	3000/Tape & Reel
DMC1030UFDBQ-13	U-DFN2020-6 (Type B)	10000/Tape & Reel

- Notes:
1. No purposely added lead. Fully EU Directive 2002/95/EC (RoHS) & 2011/65/EU (RoHS 2) compliant.
  2. See [http://www.diodes.com/quality/lead\\_free.html](http://www.diodes.com/quality/lead_free.html) for more information about Diodes Incorporated's definitions of Halogen- and Antimony-free, "Green" and Lead-free.
  3. Halogen- and Antimony-free "Green" products are defined as those which contain <900ppm bromine, <900ppm chlorine (<1500ppm total Br + Cl) and <1000ppm antimony compounds.
  4. Automotive products are AEC-Q101 qualified and are PPAP capable. Refer to [http://www.diodes.com/product\\_compliance\\_definitions.html](http://www.diodes.com/product_compliance_definitions.html).
  5. For packaging details, go to our website at <http://www.diodes.com/products/packages.html>.

## Marking Information

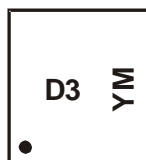

D3 = Product Type Marking Code  
 YM = Date Code Marking  
 Y = Year (ex: D = 2016)  
 M = Month (ex: 9 = September)

### Date Code Key

Year	2015	2016	2017	2018	2019	2020	2021
Code	C	D	E	F	G	H	I

Month	Jan	Feb	Mar	Apr	May	Jun	Jul	Aug	Sep	Oct	Nov	Dec
Code	1	2	3	4	5	6	7	8	9	O	N	D

**Maximum Ratings** (@T<sub>A</sub> = +25°C, unless otherwise specified.)

Characteristic	Symbol	Q1 N-CHANNEL	Q2 P-CHANNEL	Unit	
Drain-Source Voltage	V <sub>DSS</sub>	12	-12	V	
Gate-Source Voltage	V <sub>GSS</sub>	±8	±8	V	
Continuous Drain Current (Note 6) N-CHANNEL: V <sub>GS</sub> = 4.5V P-CHANNEL: V <sub>GS</sub> = -4.5V	Steady State T <sub>A</sub> = +25°C T <sub>A</sub> = +70°C	I <sub>D</sub>	5.1 4.1	-3.9 -3.1	A
		t < 5s T <sub>A</sub> = +25°C T <sub>A</sub> = +70°C	I <sub>D</sub>	6.6 5.3	-5.0 -4.0
Maximum Continuous Body Diode Forward Current (Note 6)	I <sub>S</sub>		2	-1.7	A
Pulsed Drain Current (10µs Pulse, Duty Cycle = 1%)	I <sub>DM</sub>	35	-25	A	
Avalanche Current (L = 0.1mH)	I <sub>AS</sub>	5	-5	A	
Avalanche Energy (L = 0.1mH)	E <sub>AS</sub>	4	4	mJ	

**Thermal Characteristics**

Characteristic	Symbol	Value	Unit
Total Power Dissipation (Note 6)	P <sub>D</sub>	1.36	W
		t < 5s 1.89	
Thermal Resistance, Junction to Ambient (Note 6)	R <sub>θJA</sub>	92	°C/W
		t < 5s 66	
Thermal Resistance, Junction to Case (Note 6)	R <sub>θJC</sub>	18	
Operating and Storage Temperature Range	T <sub>J</sub> , T <sub>STG</sub>	-55 to +150	°C

**Electrical Characteristics Q1 N-CHANNEL** (@ T<sub>A</sub> = +25°C, unless otherwise specified.)

Characteristic	Symbol	Min	Typ	Max	Unit	Test Condition
<b>OFF CHARACTERISTICS (Note 7)</b>						
Drain-Source Breakdown Voltage	BV <sub>DSS</sub>	12	—	—	V	V <sub>GS</sub> = 0V, I <sub>D</sub> = 250µA
Zero Gate Voltage Drain Current T <sub>J</sub> = +25°C	I <sub>DSS</sub>	—	—	1.0	µA	V <sub>DS</sub> = 12V, V <sub>GS</sub> = 0V
Gate-Source Leakage	I <sub>GSS</sub>	—	—	±10	µA	V <sub>GS</sub> = ±8V, V <sub>DS</sub> = 0V
<b>ON CHARACTERISTICS (Note 7)</b>						
Gate Threshold Voltage	V <sub>GS(TH)</sub>	0.4	—	1	V	V <sub>DS</sub> = V <sub>GS</sub> , I <sub>D</sub> = 250µA
Static Drain-Source On-Resistance	R <sub>DS(ON)</sub>	—	17	34	mΩ	V <sub>GS</sub> = 4.5V, I <sub>D</sub> = 4.6A
		—	20	40		V <sub>GS</sub> = 2.5V, I <sub>D</sub> = 4.2A
		—	24	50		V <sub>GS</sub> = 1.8V, I <sub>D</sub> = 3.8A
		—	28	70		V <sub>GS</sub> = 1.5V, I <sub>D</sub> = 1.5A
Diode Forward Voltage	V <sub>SD</sub>	—	0.7	1.2	V	V <sub>GS</sub> = 0V, I <sub>S</sub> = 4.8A
<b>DYNAMIC CHARACTERISTICS (Note 8)</b>						
Input Capacitance	C <sub>ISS</sub>	—	1003	—	pF	V <sub>DS</sub> = 6V, V <sub>GS</sub> = 0V, f = 1.0MHz
Output Capacitance	C <sub>OSS</sub>	—	132	—	pF	
Reverse Transfer Capacitance	C <sub>RSS</sub>	—	115	—	pF	
Gate Resistance	R <sub>g</sub>	—	11.3	—	Ω	V <sub>DS</sub> = 0V, V <sub>GS</sub> = 0V, f = 1MHz
Total Gate Charge (V <sub>GS</sub> = 4.5V)	Q <sub>g</sub>	—	12.2	—	nC	V <sub>DS</sub> = 10V, I <sub>D</sub> = 6.8A
Total Gate Charge (V <sub>GS</sub> = 8V)		—	23.1	—	nC	
Gate-Source Charge	Q <sub>gs</sub>	—	1.3	—	nC	
Gate-Drain Charge	Q <sub>gd</sub>	—	1.5	—	nC	
Turn-On Delay Time	t <sub>D(ON)</sub>	—	4.4	—	ns	V <sub>DD</sub> = 6V, V <sub>GS</sub> = 4.5V, R <sub>L</sub> = 1.1Ω, R <sub>G</sub> = 1Ω
Turn-On Rise Time	t <sub>r</sub>	—	7.4	—	ns	
Turn-Off Delay Time	t <sub>D(OFF)</sub>	—	18.8	—	ns	
Turn-Off Fall Time	t <sub>f</sub>	—	4.9	—	ns	
Body Diode Reverse Recovery Time	t <sub>RR</sub>	—	7.6	—	ns	
Body Diode Reverse Recovery Charge	Q <sub>RR</sub>	—	0.9	—	nC	I <sub>S</sub> = 5.4A, dI/dt = 100A/µs

- Notes: 6. Device mounted on 1" x 1" FR-4 PCB with high coverage 2oz. Copper, single sided.  
7. Short duration pulse test used to minimize self-heating effect.  
8. Guaranteed by design. Not subject to product testing.

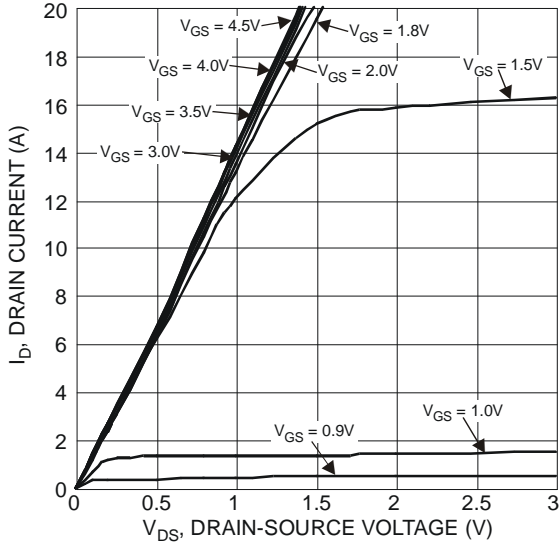

Figure 1 Typical Output Characteristics

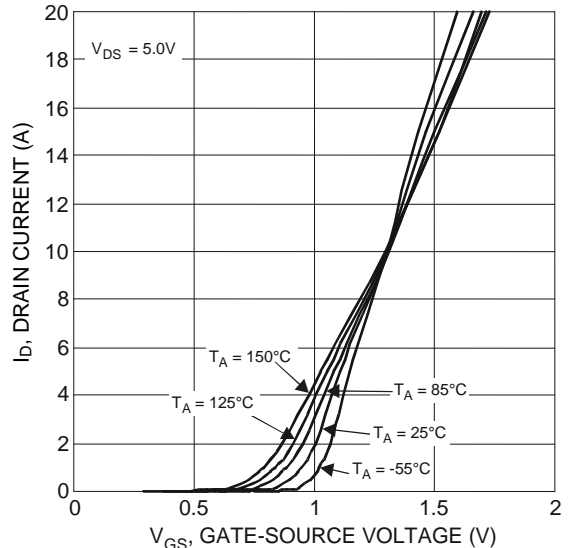

Figure 2 Typical Transfer Characteristics

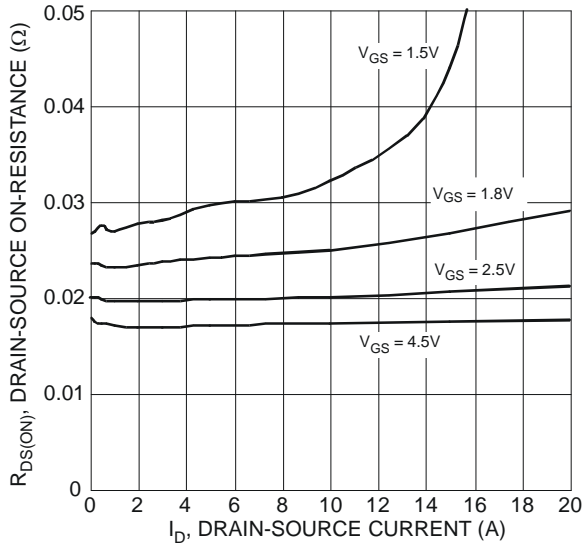

Figure 3 Typical On-Resistance vs. Drain Current and Gate Voltage

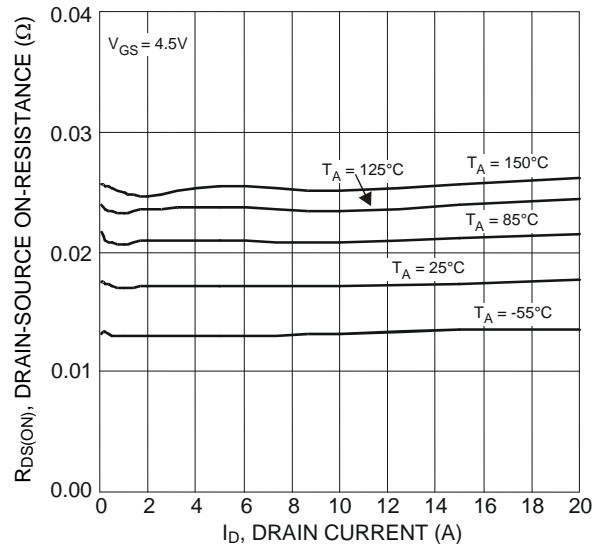

Figure 4 Typical On-Resistance vs. Drain Current and Temperature

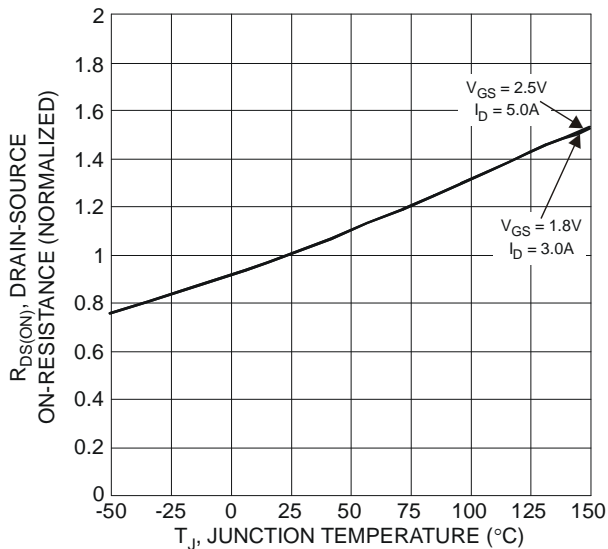

Figure 5 On-Resistance Variation with Temperature

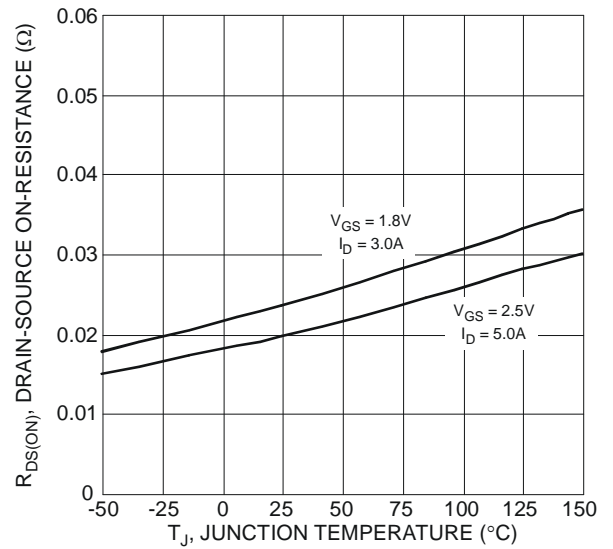

Figure 6 On-Resistance Variation with Temperature

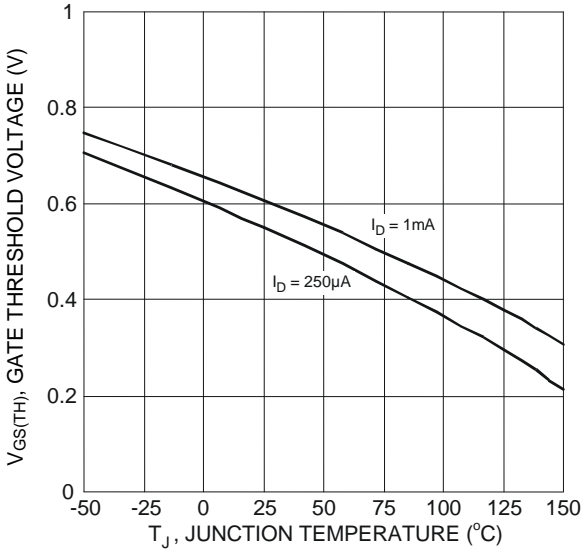

Figure 7 Gate Threshold Variation vs. Junction Temperature

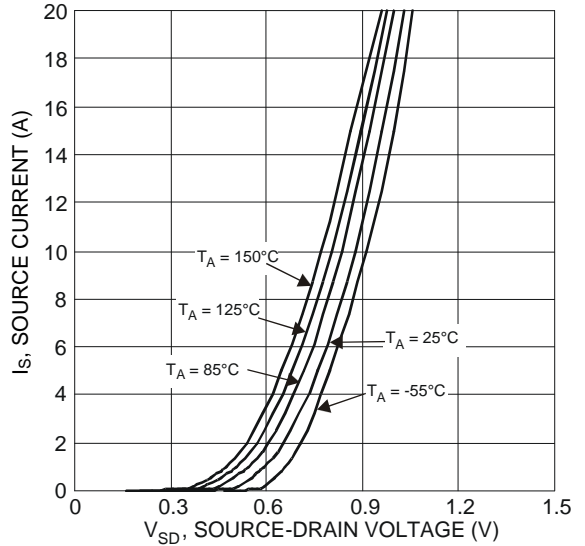

Figure 8 Diode Forward Voltage vs. Current

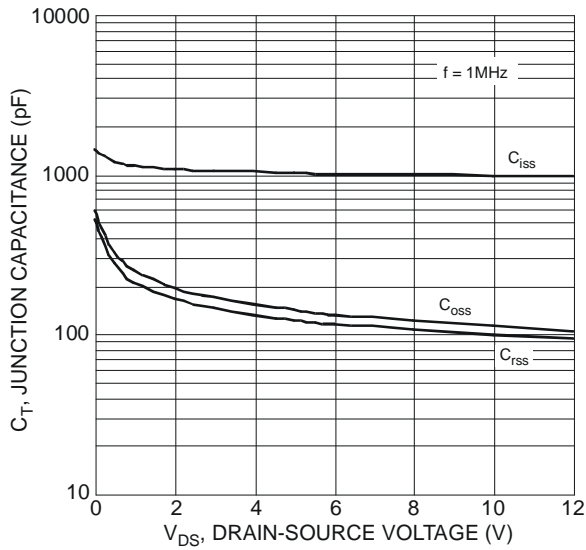

Figure 9 Typical Junction Capacitance

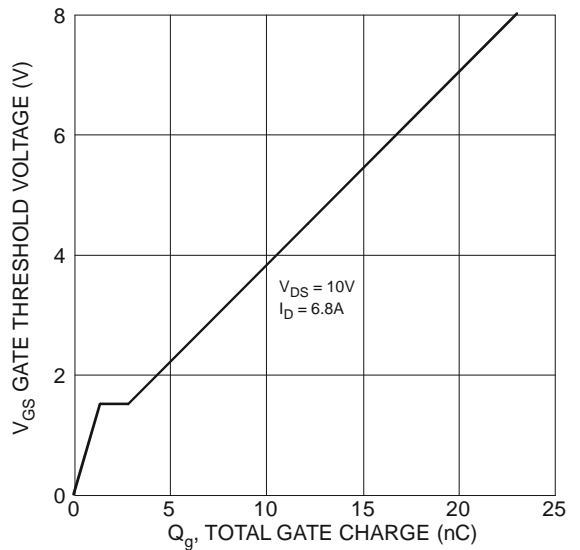

Figure 10 Gate Charge

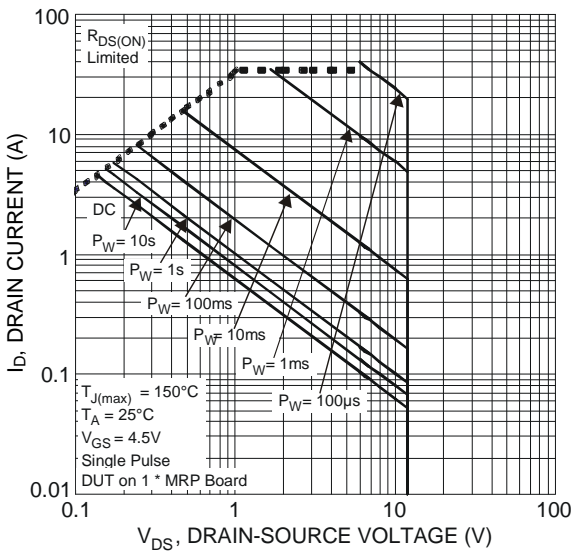

Figure 11 SOA Safe Operation Area

**Electrical Characteristics Q2 P-CHANNEL** (@  $T_A = +25^\circ\text{C}$ , unless otherwise specified.)

Characteristic	Symbol	Min	Typ	Max	Unit	Test Condition
<b>OFF CHARACTERISTICS (Note 7)</b>						
Drain-Source Breakdown Voltage	$BV_{DSS}$	-12	—	—	V	$V_{GS} = 0V, I_D = -250\mu A$
Zero Gate Voltage Drain Current $T_J = +25^\circ\text{C}$	$I_{DSS}$	—	—	-1.0	$\mu A$	$V_{DS} = -12V, V_{GS} = 0V$
Gate-Source Leakage	$I_{GSS}$	—	—	$\pm 10$	$\mu A$	$V_{GS} = \pm 8V, V_{DS} = 0V$
<b>ON CHARACTERISTICS (Note 7)</b>						
Gate Threshold Voltage	$V_{GS(TH)}$	-0.4	—	-1	V	$V_{DS} = V_{GS}, I_D = -250\mu A$
Static Drain-Source On-Resistance	$R_{DS(ON)}$	—	37	59	m $\Omega$	$V_{GS} = -4.5V, I_D = -3.6A$
		—	48	81		$V_{GS} = -2.5V, I_D = -3.1A$
		—	69	115		$V_{GS} = -1.8V, I_D = -2.6A$
		—	88	215		$V_{GS} = -1.5V, I_D = -0.5A$
Diode Forward Voltage	$V_{SD}$	—	-0.7	-1.2	V	$V_{GS} = 0V, I_S = -3.7A$
<b>DYNAMIC CHARACTERISTICS (Note 8)</b>						
Input Capacitance	$C_{iss}$	—	1028	—	pF	$V_{DS} = -6V, V_{GS} = 0V,$ $f = 1.0\text{MHz}$
Output Capacitance	$C_{oss}$	—	285	—	pF	
Reverse Transfer Capacitance	$C_{rss}$	—	254	—	pF	
Gate Resistance	$R_g$	—	19.6	—	$\Omega$	$V_{DS} = 0V, V_{GS} = 0V, f = 1\text{MHz}$
Total Gate Charge ( $V_{GS} = -4.5V$ )	$Q_g$	—	13	—	nC	$V_{DS} = -10V, I_D = -4.7A$
Total Gate Charge ( $V_{GS} = -8V$ )		—	20.8	—	nC	
Gate-Source Charge	$Q_{gs}$	—	1.8	—	nC	
Gate-Drain Charge	$Q_{gd}$	—	4.5	—	nC	
Turn-On Delay Time	$t_{D(ON)}$	—	5.6	—	ns	$V_{DD} = -6V, V_{GS} = -4.5V,$ $R_L = 1.6\Omega, R_G = 1\Omega$
Turn-On Rise Time	$t_R$	—	12.8	—	ns	
Turn-Off Delay Time	$t_{D(OFF)}$	—	30.7	—	ns	
Turn-Off Fall Time	$t_F$	—	25.4	—	ns	
Body Diode Reverse Recovery Time	$t_{RR}$	—	31.6	—	ns	$I_S = -3.6A, dI/dt = 100A/\mu s$
Body Diode Reverse Recovery Charge	$Q_{RR}$	—	7.8	—	nC	$I_S = -3.6A, dI/dt = 100A/\mu s$

Notes: 7. Short duration pulse test used to minimize self-heating effect.  
8. Guaranteed by design. Not subject to product testing.

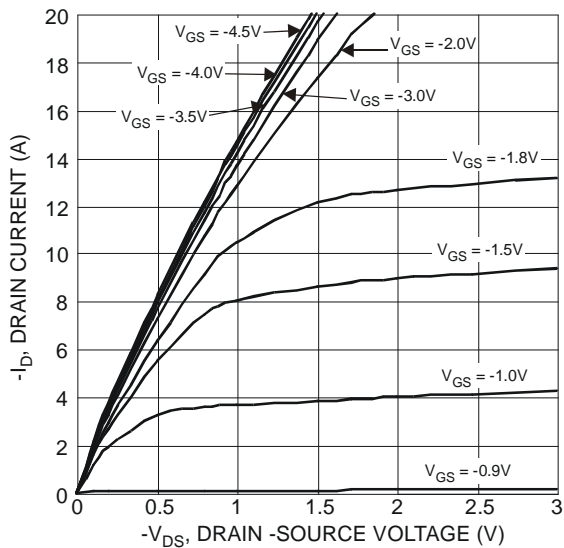

Figure 12 Typical Output Characteristics

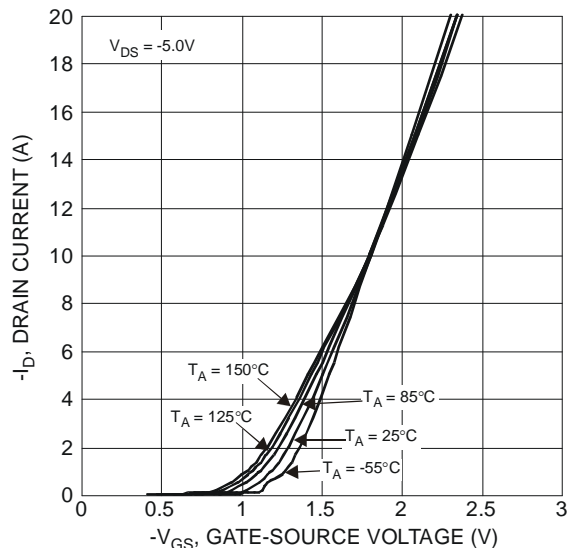

Figure 13 Typical Transfer Characteristics

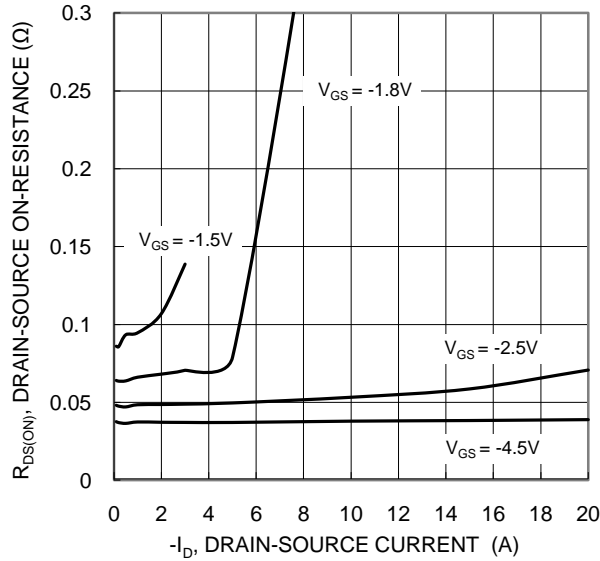

Figure 14 Typical On-Resistance vs. Drain Current and Gate Voltage

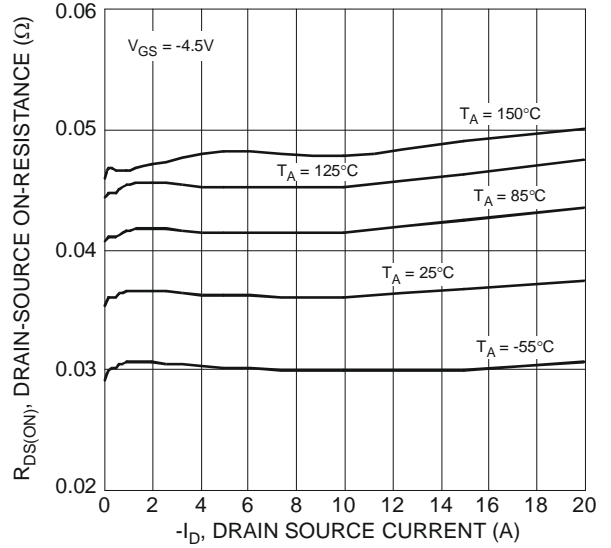

Figure 15 Typical On-Resistance vs. Drain Current and Temperature

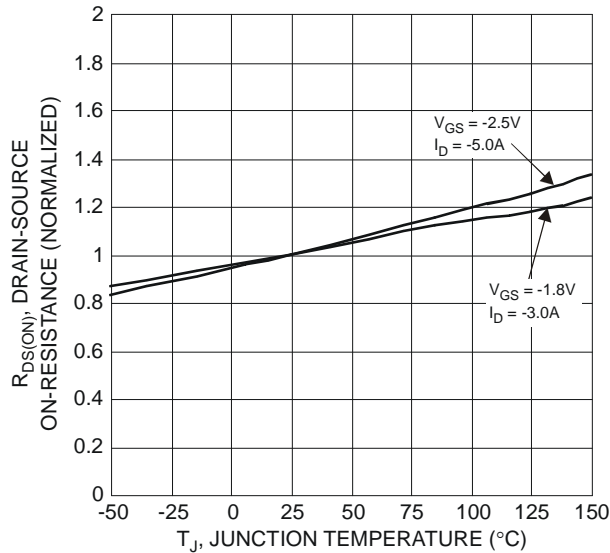

Figure 16 On-Resistance Variation with Temperature

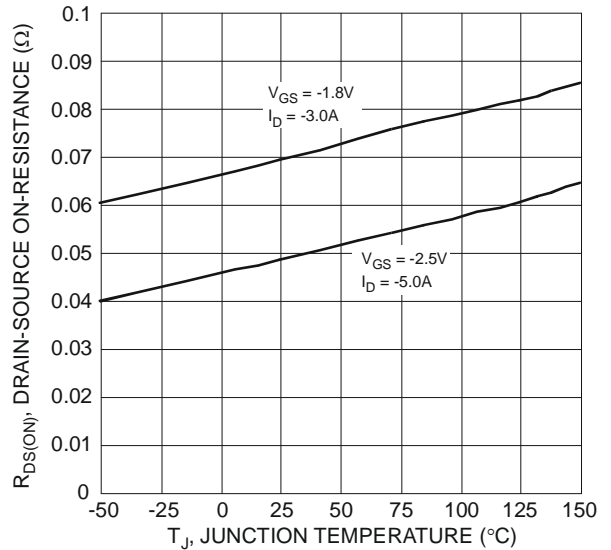

Figure 17 On-Resistance Variation with Temperature

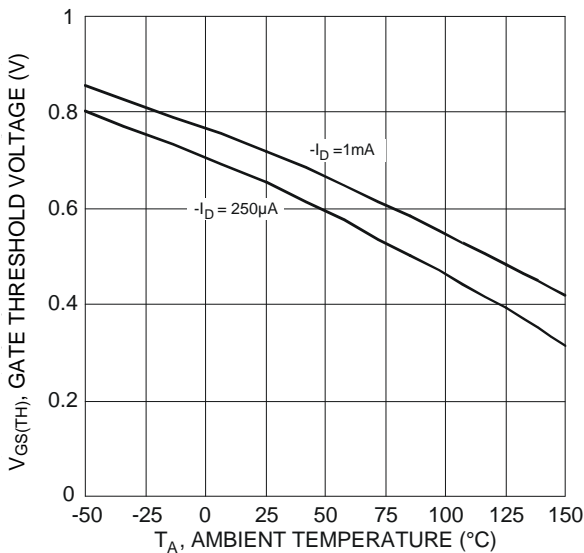

Figure 18 Gate Threshold Variation vs. Ambient Temperature

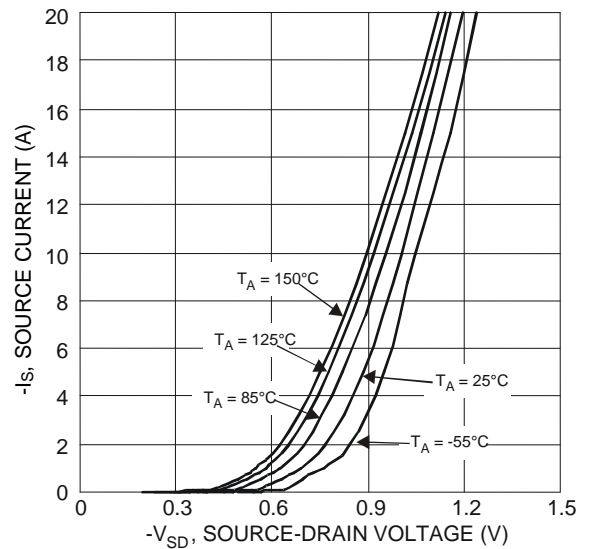

Figure 19 Diode Forward Voltage vs. Current

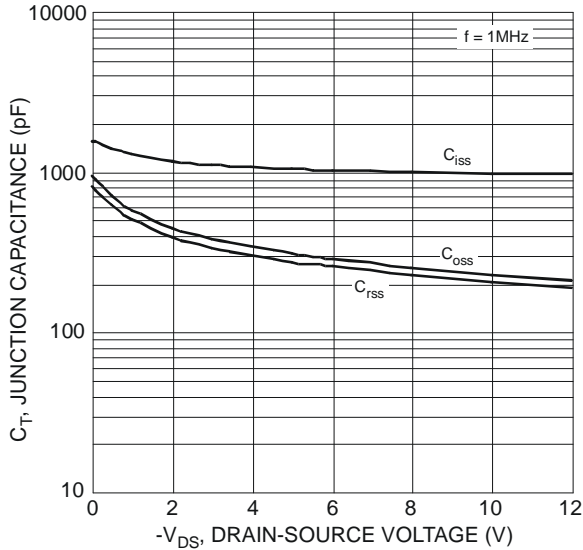

Figure 20 Typical Junction Capacitance

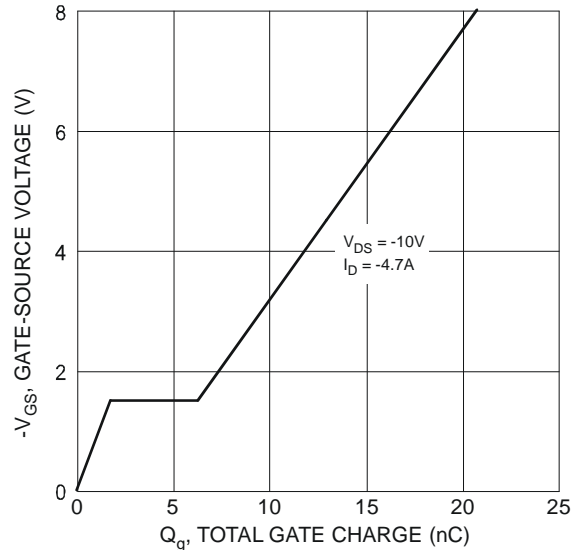

Figure 21 Gate-Charge Characteristics

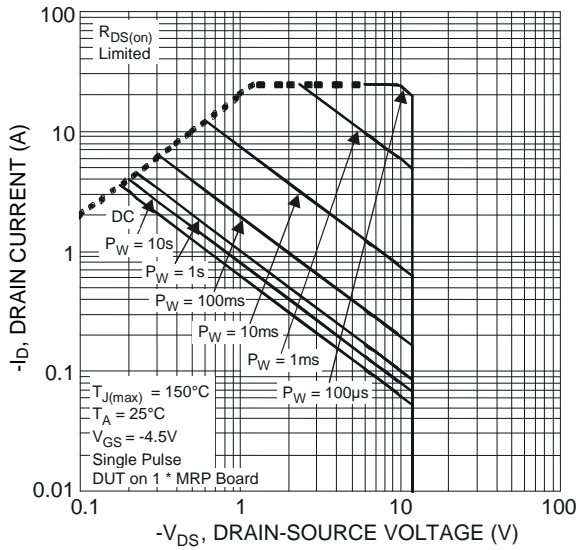

Figure 22 SOA Safe Operation Area

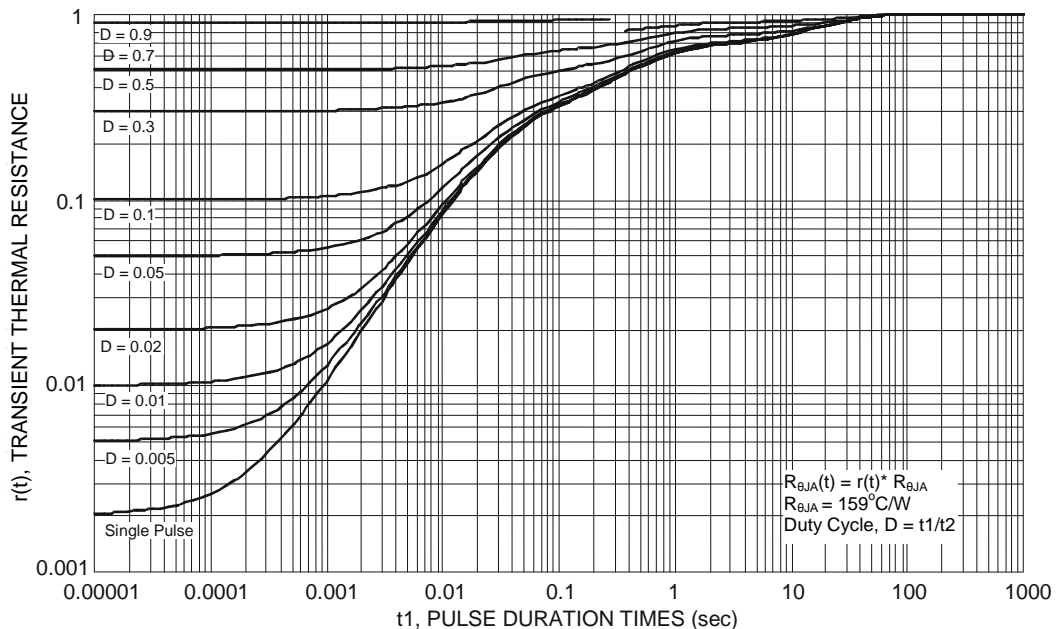
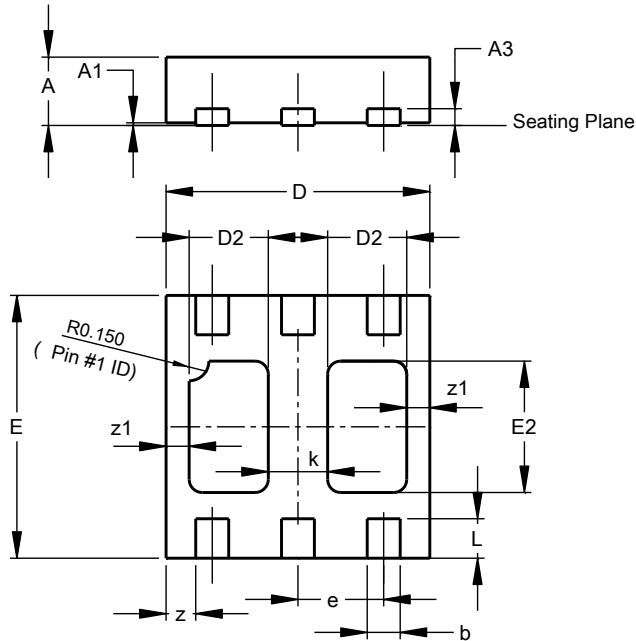

Figure 23 Transient Thermal Resistance

**Package Outline Dimensions**

Please see AP02001 at [http://www.diodes.com/\\_files/datasheets/ap02001.pdf](http://www.diodes.com/_files/datasheets/ap02001.pdf) for the latest version.

**U-DFN2020-6 (Type B)**



U-DFN2020-6 Type B			
Dim	Min	Max	Typ
A	0.545	0.605	0.575
A1	0.00	0.05	0.02
A3	-	-	0.13
b	0.20	0.30	0.25
D	1.95	2.075	2.00
D2	0.50	0.70	0.60
e	-	-	0.65
E	1.95	2.075	2.00
E2	0.90	1.10	1.00
k	-	-	0.45
L	0.25	0.35	0.30
z	-	-	0.225
z1	-	-	0.175
All Dimensions in mm			

**Suggested Pad Layout**

Please see AP02001 at [http://www.diodes.com/\\_files/datasheets/ap02001.pdf](http://www.diodes.com/_files/datasheets/ap02001.pdf) for the latest version.

**U-DFN2020-6 (Type B)**

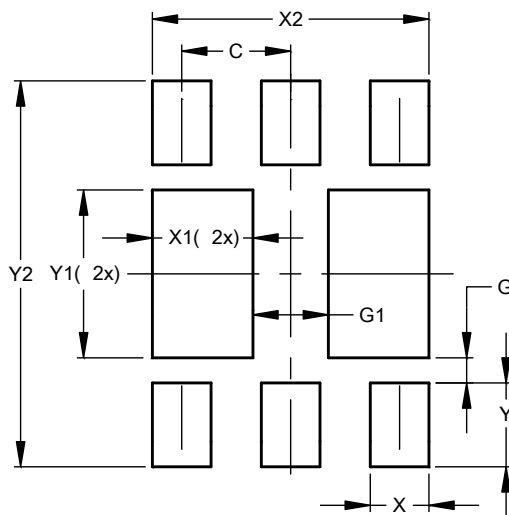

Dimensions	Value (in mm)
C	0.650
G	0.150
G1	0.450
X	0.350
X1	0.600
X2	1.650
Y	0.500
Y1	1.000
Y2	2.300

**IMPORTANT NOTICE**

DIODES INCORPORATED MAKES NO WARRANTY OF ANY KIND, EXPRESS OR IMPLIED, WITH REGARDS TO THIS DOCUMENT, INCLUDING, BUT NOT LIMITED TO, THE IMPLIED WARRANTIES OF MERCHANTABILITY AND FITNESS FOR A PARTICULAR PURPOSE (AND THEIR EQUIVALENTS UNDER THE LAWS OF ANY JURISDICTION).

Diodes Incorporated and its subsidiaries reserve the right to make modifications, enhancements, improvements, corrections or other changes without further notice to this document and any product described herein. Diodes Incorporated does not assume any liability arising out of the application or use of this document or any product described herein; neither does Diodes Incorporated convey any license under its patent or trademark rights, nor the rights of others. Any Customer or user of this document or products described herein in such applications shall assume all risks of such use and will agree to hold Diodes Incorporated and all the companies whose products are represented on Diodes Incorporated website, harmless against all damages.

Diodes Incorporated does not warrant or accept any liability whatsoever in respect of any products purchased through unauthorized sales channel. Should Customers purchase or use Diodes Incorporated products for any unintended or unauthorized application, Customers shall indemnify and hold Diodes Incorporated and its representatives harmless against all claims, damages, expenses, and attorney fees arising out of, directly or indirectly, any claim of personal injury or death associated with such unintended or unauthorized application.

Products described herein may be covered by one or more United States, international or foreign patents pending. Product names and markings noted herein may also be covered by one or more United States, international or foreign trademarks.

This document is written in English but may be translated into multiple languages for reference. Only the English version of this document is the final and determinative format released by Diodes Incorporated.

**LIFE SUPPORT**

Diodes Incorporated products are specifically not authorized for use as critical components in life support devices or systems without the express written approval of the Chief Executive Officer of Diodes Incorporated. As used herein:

A. Life support devices or systems are devices or systems which:

1. are intended to implant into the body, or
2. support or sustain life and whose failure to perform when properly used in accordance with instructions for use provided in the labeling can be reasonably expected to result in significant injury to the user.

B. A critical component is any component in a life support device or system whose failure to perform can be reasonably expected to cause the failure of the life support device or to affect its safety or effectiveness.

Customers represent that they have all necessary expertise in the safety and regulatory ramifications of their life support devices or systems, and acknowledge and agree that they are solely responsible for all legal, regulatory and safety-related requirements concerning their products and any use of Diodes Incorporated products in such safety-critical, life support devices or systems, notwithstanding any devices- or systems-related information or support that may be provided by Diodes Incorporated. Further, Customers must fully indemnify Diodes Incorporated and its representatives against any damages arising out of the use of Diodes Incorporated products in such safety-critical, life support devices or systems.

Copyright © 2016, Diodes Incorporated

**[www.diodes.com](http://www.diodes.com)**



## Стандарт Электрон Связь

Мы молодая и активно развивающаяся компания в области поставок электронных компонентов. Мы поставляем электронные компоненты отечественного и импортного производства напрямую от производителей и с крупнейших складов мира.

Благодаря сотрудничеству с мировыми поставщиками мы осуществляем комплексные и плановые поставки широчайшего спектра электронных компонентов.

Собственная эффективная логистика и склад в обеспечивает надежную поставку продукции в точно указанные сроки по всей России.

Мы осуществляем техническую поддержку нашим клиентам и предпродажную проверку качества продукции. На все поставляемые продукты мы предоставляем гарантию .

Осуществляем поставки продукции под контролем ВП МО РФ на предприятия военно-промышленного комплекса России , а также работаем в рамках 275 ФЗ с открытием отдельных счетов в уполномоченном банке. Система менеджмента качества компании соответствует требованиям ГОСТ ISO 9001.

Минимальные сроки поставки, гибкие цены, неограниченный ассортимент и индивидуальный подход к клиентам являются основой для выстраивания долгосрочного и эффективного сотрудничества с предприятиями радиоэлектронной промышленности, предприятиями ВПК и научно-исследовательскими институтами России.

С нами вы становитесь еще успешнее!

### Наши контакты:

**Телефон:** +7 812 627 14 35

**Электронная почта:** [sales@st-electron.ru](mailto:sales@st-electron.ru)

**Адрес:** 198099, Санкт-Петербург,  
Промышленная ул, дом № 19, литера Н,  
помещение 100-Н Офис 331