



SANYO Semiconductors

DATA SHEET

An ON Semiconductor Company

2SB1215/2SD1815 — PNP/NPN Epitaxial Planar Silicon Transistor

High-Current Switching Applications

Applications

- Relay drivers, high-speed inverters, converters, and other general high-current switching applications

Features

- Low collector-to-emitter saturation voltage
- Small-sized package permitting 2SB1215/2SD1815-applied sets to be made small and slim
- High f_T
- Excellent linearity of h_{FE}
- Fast switching time

Specifications () : 2SB1215

Absolute Maximum Ratings at $T_a=25^\circ\text{C}$

Parameter	Symbol	Conditions	Ratings	Unit
Collector-to-Base Voltage	V_{CBO}		(-)120	V
Collector-to-Emitter Voltage	V_{CEO}		(-)100	V
Emitter-to-Base Voltage	V_{EBO}		(-)6	V
Collector Current	I_C		(-)3	A
Collector Current (Pulse)	I_{CP}		(-)6	A

Continued on next page.

Package Dimensions unit : mm (typ.)

7518-003

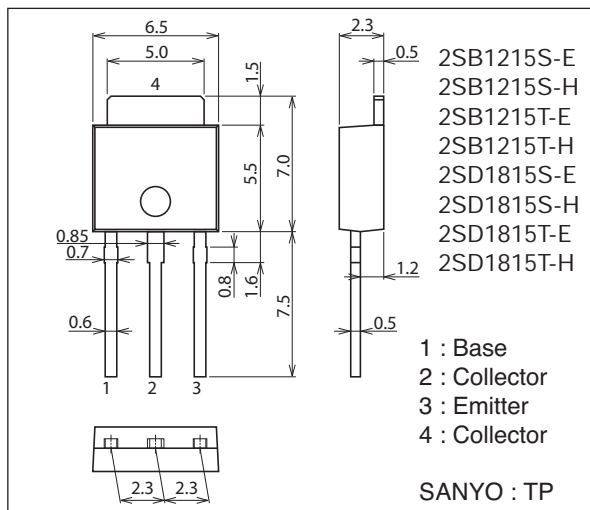

Package Dimensions unit : mm (typ.)

7003-003

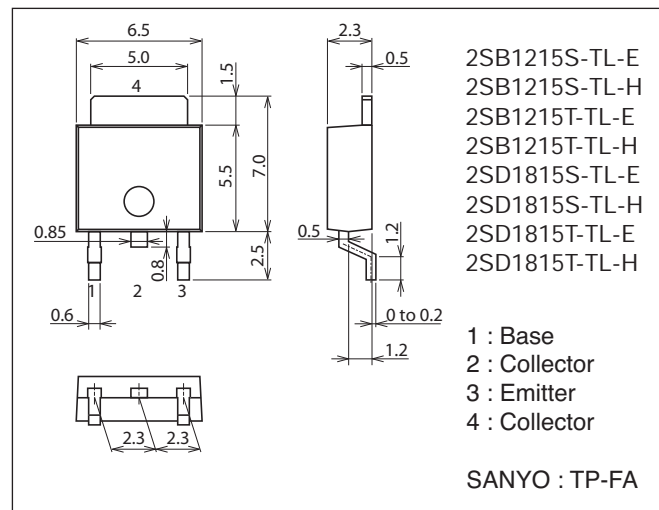

Product & Package Information

- Package : TP
- JEITA, JEDEC : SC-64, TO-251, SOT-553, DPAK
- Minimum Packing Quantity : 500 pcs./bag

- Package : TP-FA
- JEITA, JEDEC : SC-63, TO-252, SOT-428, DPAK
- Minimum Packing Quantity : 700 pcs./reel

Marking (TP, TP-FA)

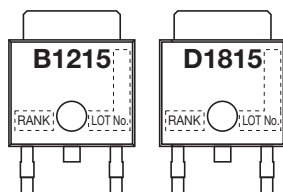

Packing Type (TP-FA) : TL

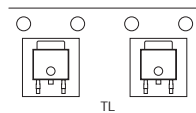

Electrical Connection

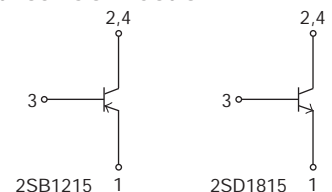

SANYO Semiconductor Co., Ltd.

<http://semicon.sanyo.com/en/network>

2SB1215/2SD1815

Continued from preceding page.

Parameter	Symbol	Conditions	Ratings	Unit
Collector Dissipation	P _C		1	W
		T _C =25°C	20	W
Junction Temperature	T _J		150	°C
Storage Temperature	T _{stg}		-55 to +150	°C

Electrical Characteristics at T_a=25°C

Parameter	Symbol	Conditions	Ratings			Unit
			min.	typ.	max.	
Collector Cutoff Current	I _{CBO}	V _{CB} =(-)100V, I _E =0A			(-)1	μA
Emitter Cutoff Current	I _{EBO}	V _{EB} =(-)4V, I _C =0A			(-)1	μA
DC Current Gain	h _{FE1}	V _{CE} =(-)5V, I _C =(-)0.5A	70*		400*	
	h _{FE2}	V _{CE} =(-)5V, I _C =(-)2A	40			
Gain-Bandwidth Product	f _T	V _{CE} =(-)10V, I _C =(-)0.5A		(130)180		MHz
Output Capacitance	C _{ob}	V _{CB} =(-)10V, f=1MHz		(40)25		pF
Collector-to-Emitter Saturation Voltage	V _{CE(sat)}	I _C =(-)1.5A, I _B =(-)0.15A		(-200)150	(-500)400	mV
Base-to-Emitter Saturation Voltage	V _{BE(sat)}	V _{CE} =(-)1.5A, I _C =(-)0.15A		(-)0.9	(-)1.2	V
Collector-to-Base Breakdown Voltage	V(BR)CBO	I _C =(-)10μA, I _E =0A	(-)120			V
Collector-to-Emitter Breakdown Voltage	V(BR)CEO	I _C =(-)1mA, R _{BE} =∞	(-)100			V
Emitter-to-Base Breakdown Voltage	V(BR)EBO	I _E =(-)10μA, I _C =0A	(-)6			V
Turn-On Time	t _{on}	See specified Test Circuit.		100		ns
Storage Time	t _{stg}			(800)900		ns
Fall Time	t _f			50		ns

* : The 2SB1215/2SD1815 are classified by 100mA h_{FE} as follows :

Rank	Q	R	S	T
h _{FE}	70 to 140	100 to 200	140 to 280	200 to 400

Switching Time Test Circuit

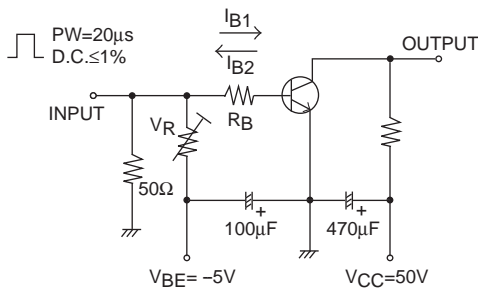

I_C=10I_{B1}= -10I_{B2}=1.5A
For PNP, the polarity is reversed.

Ordering Information

Device	Package	Shipping	memo
2SB1215S-E	TP	500pcs./bag	Pb Free
2SB1215S-H	TP	500pcs./bag	Pb Free and Halogen Free
2SB1215T-E	TP	500pcs./bag	Pb Free
2SB1215T-H	TP	500pcs./bag	Pb Free and Halogen Free
2SD1815S-E	TP	500pcs./bag	Pb Free
2SD1815S-H	TP	500pcs./bag	Pb Free and Halogen Free
2SD1815T-E	TP	500pcs./bag	Pb Free
2SD1815T-H	TP	500pcs./bag	Pb Free and Halogen Free
2SB1215S-TL-E	TP-FA	700pcs./reel	Pb Free
2SB1215S-TL-H	TP-FA	700pcs./reel	Pb Free and Halogen Free
2SB1215T-TL-E	TP-FA	700pcs./reel	Pb Free
2SB1215T-TL-H	TP-FA	700pcs./reel	Pb Free and Halogen Free
2SD1815S-TL-E	TP-FA	700pcs./reel	Pb Free
2SD1815S-TL-H	TP-FA	700pcs./reel	Pb Free and Halogen Free
2SD1815T-TL-E	TP-FA	700pcs./reel	Pb Free
2SD1815T-TL-H	TP-FA	700pcs./reel	Pb Free and Halogen Free

2SB1215/2SD1815

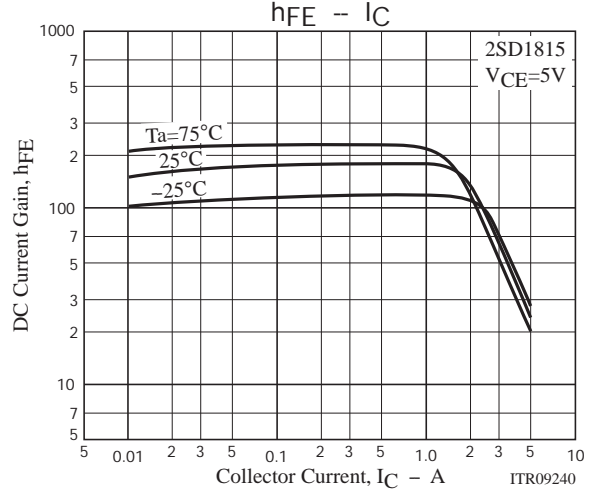
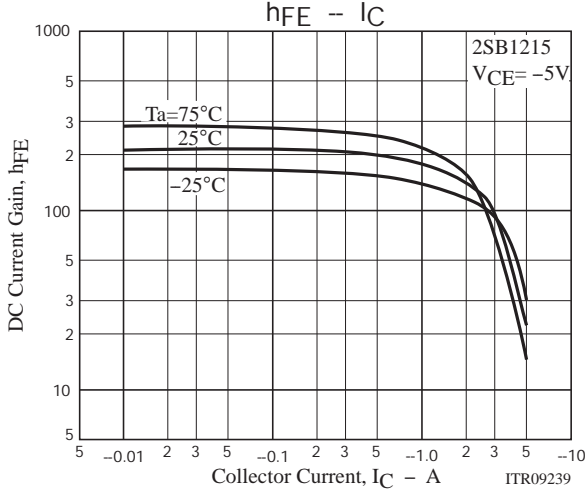
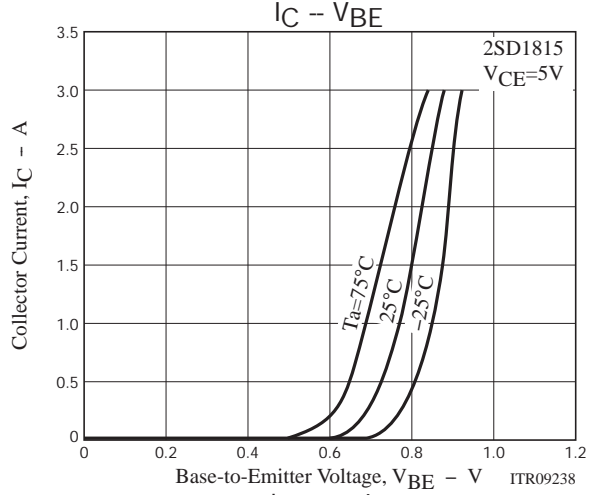
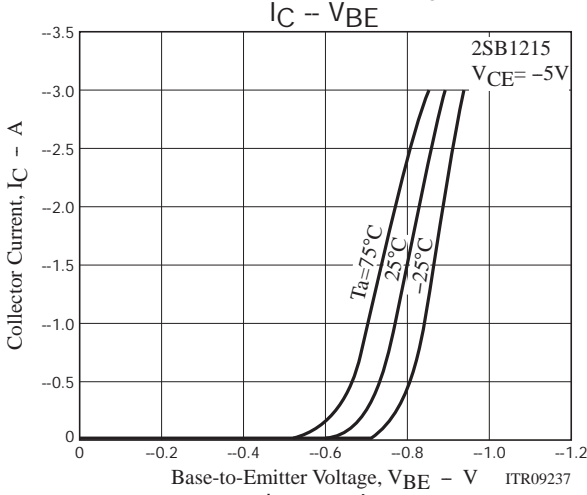
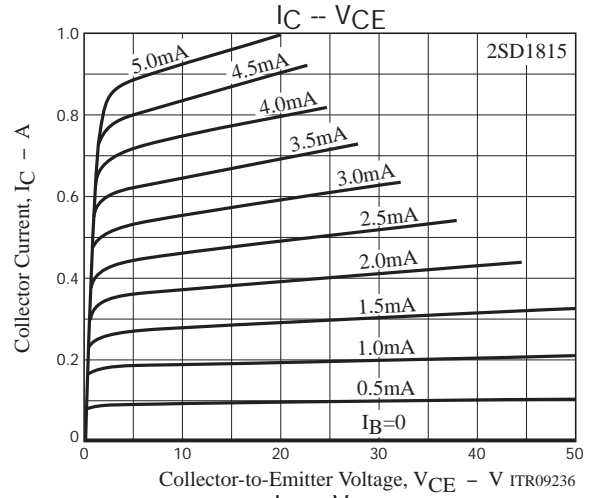
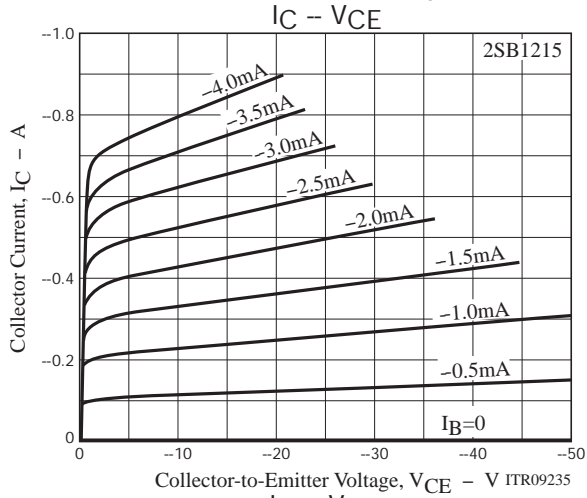
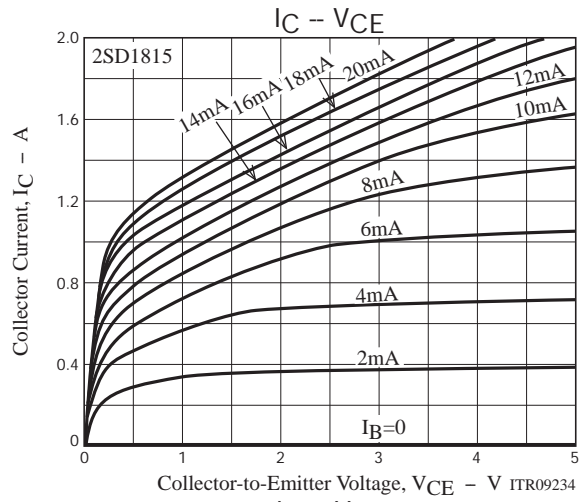
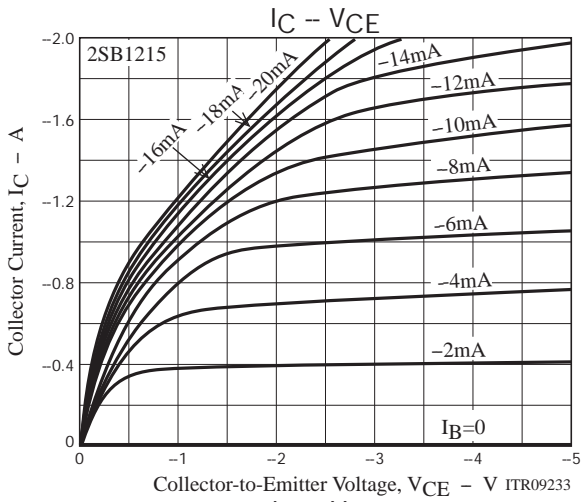

2SB1215/2SD1815

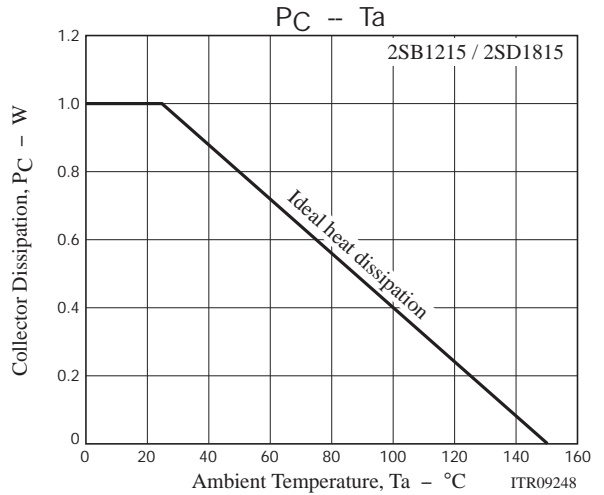
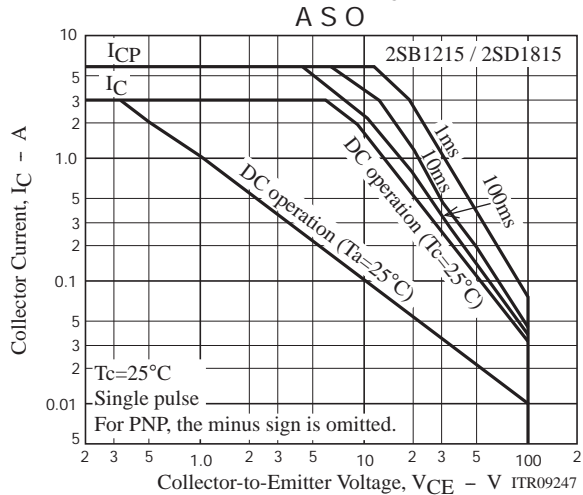
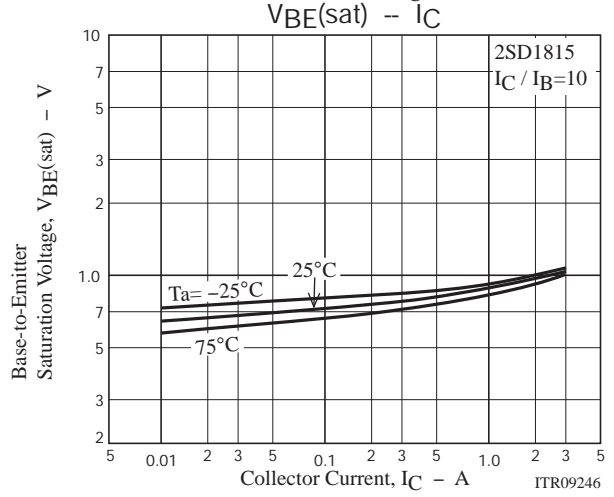
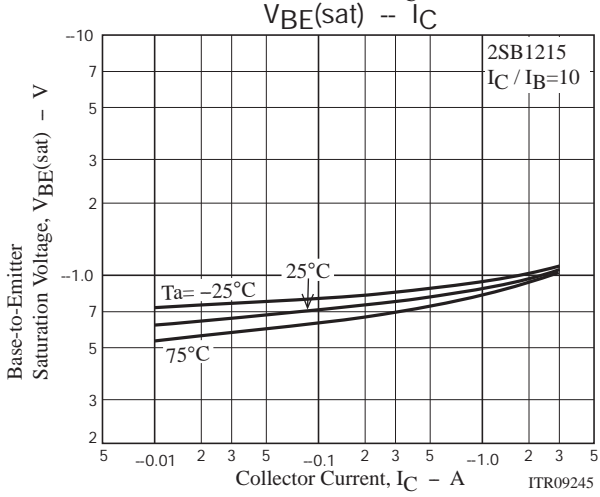
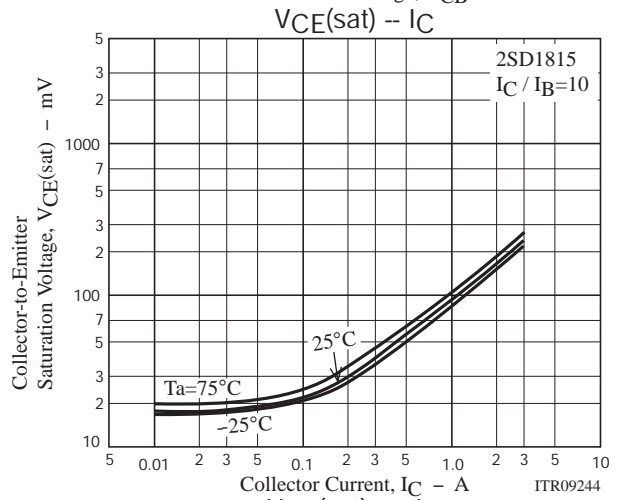
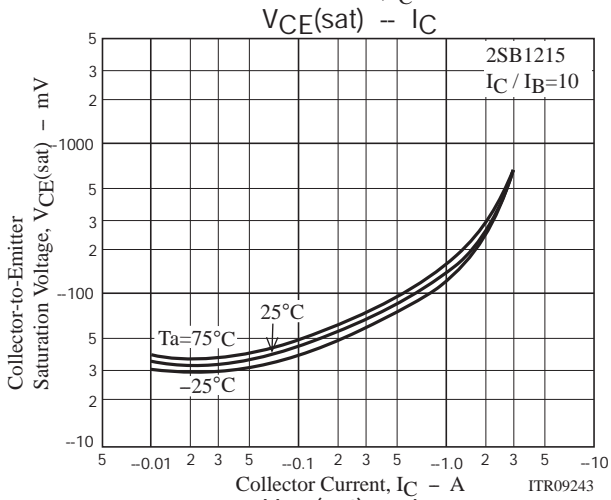
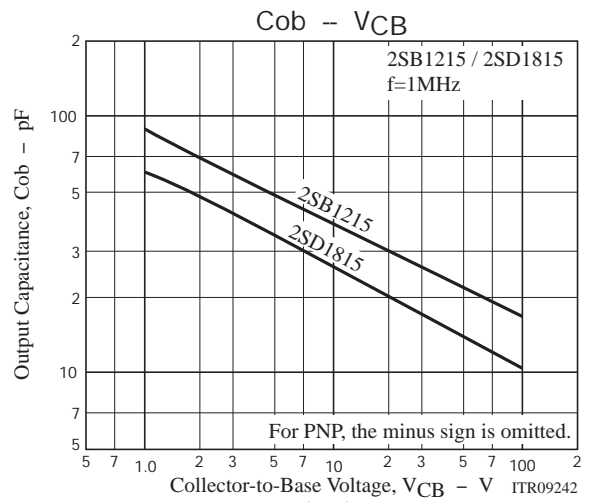
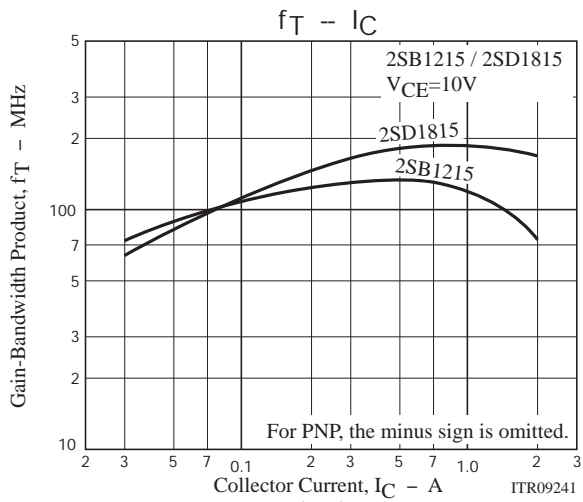

2SB1215/2SD1815

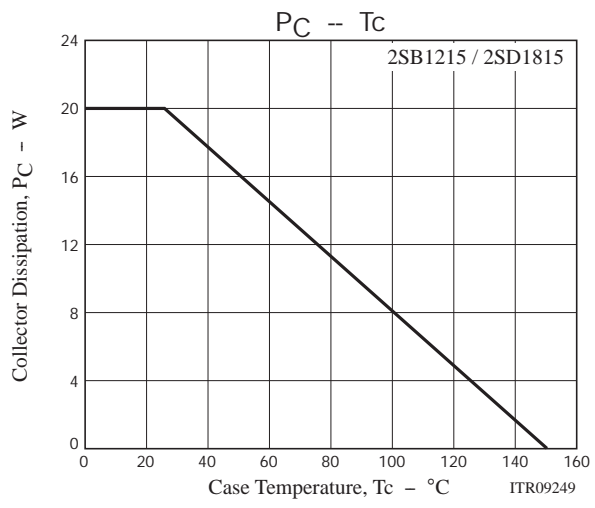

2SB1215/2SD1815

Taping Specification

2SB1215S-TL-E, 2SB1215S-TL-H, 2SB1215T-TL-E, 2SB1215T-TL-H, 2SD1815S-TL-E, 2SD1815S-TL-H, 2SD1815T-TL-E, 2SD1815T-TL-H

Packing Format

Package Name	Carrier Tape Type	Maximum Number of devices contained (pcs)			Packing format	
		Reel	Inner box	Outer box	Inner BOX (C-1)	Outer BOX (A-7)
TP-FA	TP	700	2,100	12,600	3 reels contained Dimensions:mm (external) 183×72×185	6 inner boxes contained Dimensions:mm (external) 440×195×210

Packing method

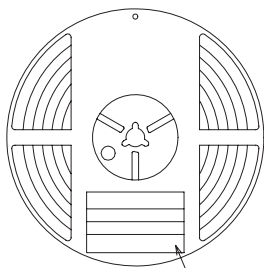

Reel label

Type No.
LOT No.
Quantity
Origin

Reel label, Inner box label
(unit: mm)

Outer box label

It is a label at the time of factory shipments.
The form of a label may change in physical distribution process.

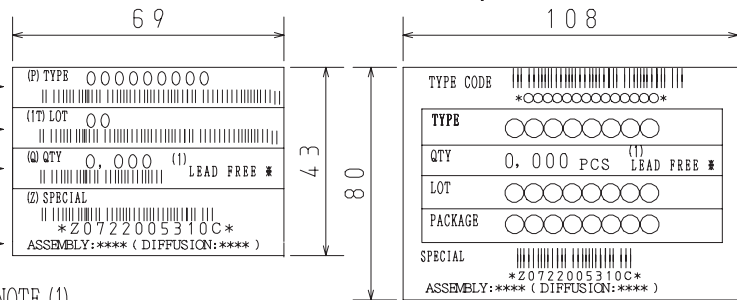

NOTE (1)

The LEAD FREE * description shows that the surface treatment of the terminal is lead free.

Label	JEITA Phase
LEAD FREE 3	JEITA Phase 3A
LEAD FREE 4	JEITA Phase 3

Taping configuration

1. Carrier tape size (unit:mm)

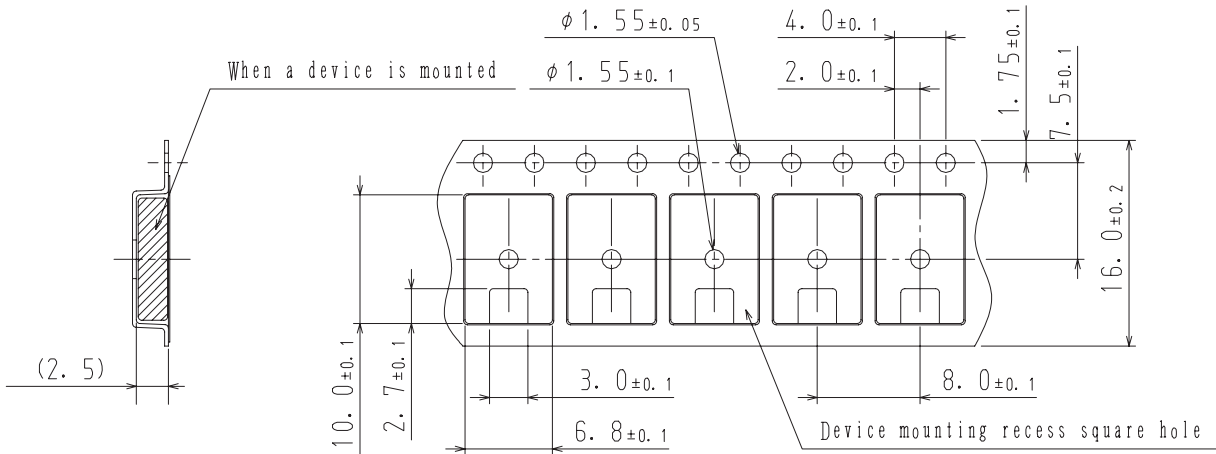

2. Device placement direction

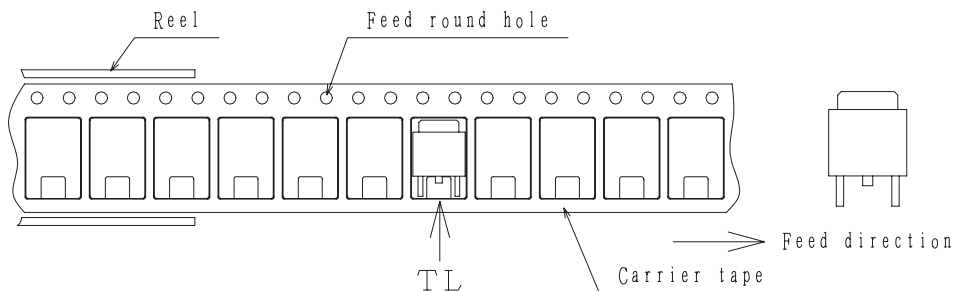

Those with one electrode terminal on the feed hole side.....TL

2SB1215/2SD1815

Outline Drawing

2SB1215S-TL-E, 2SB1215S-TL-H, 2SB1215T-TL-E, 2SB1215T-TL-H, 2SD1815S-TL-E, 2SD1815S-TL-H, 2SD1815T-TL-E, 2SD1815T-TL-H

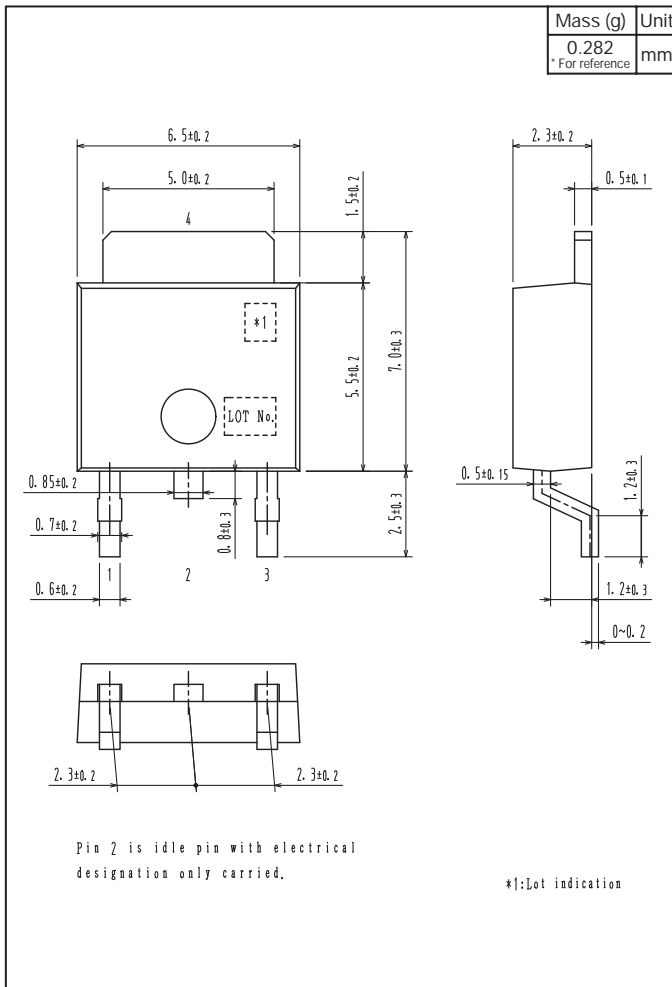

Land Pattern Example

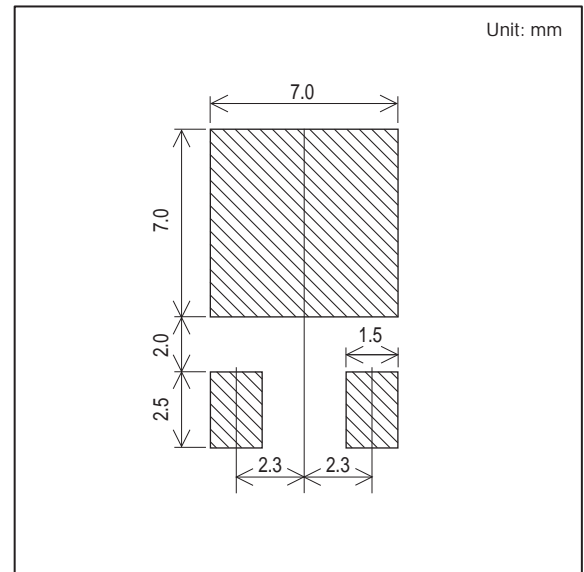

2SB1215/2SD1815

Bag Packing Specification

2SB1215S-E, 2SB1215S-H, 2SB1215T-E, 2SB1215T-H, 2SD1815S-E, 2SD1815S-H, 2SD1815T-E, 2SD1815T-H

1. Packing Format

Package Name	Maximum Number of devices contained (pcs)			
	Bag	Inner box	Outer box	
TP	500	B-1	A-1	A-2
		10,000	50,000	30,000
	Packing format (Dimensions:mm (external))			
		Inner box	Outer box	
		B-1	A-1	A-2
		445×225×55	470×250×300	470×250×190

2. Bag dimensions (unit:mm)

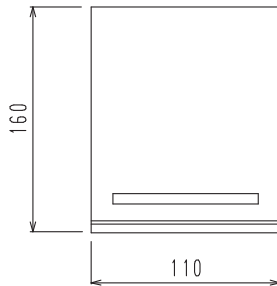

3. Bag label, Inner box label (unit:mm)

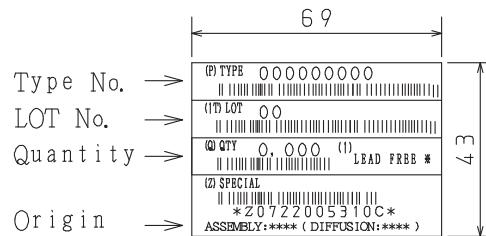

4. Outer box label (unit:mm)

It is a label at the time of factory shipments.
The form of a label may change in physical distribution process.

NOTE (1)

The LEAD FREE * description shows that the surface treatment of the terminal is lead free.

Label	JEITA Phase
LEAD FREE 3	JEITA Phase 3A
LEAD FREE 4	JEITA Phase 3

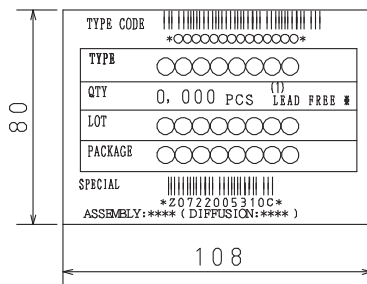

2SB1215/2SD1815

Outline Drawing

2SB1215S-E, 2SB1215S-H, 2SB1215T-E, 2SB1215T-H, 2SD1815S-E, 2SD1815S-H, 2SD1815T-E, 2SD1815T-H



- Any and all SANYO Semiconductor Co.,Ltd. products described or contained herein are, with regard to "standard application", intended for the use as general electronics equipment. The products mentioned herein shall not be intended for use for any "special application" (medical equipment whose purpose is to sustain life, aerospace instrument, nuclear control device, burning appliances, transportation machine, traffic signal system, safety equipment etc.) that shall require extremely high level of reliability and can directly threaten human lives in case of failure or malfunction of the product or may cause harm to human bodies, nor shall they grant any guarantee thereof. If you should intend to use our products for new introduction or other application different from current conditions on the usage of automotive device, communication device, office equipment, industrial equipment etc. , please consult with us about usage condition (temperature, operation time etc.) prior to the intended use. If there is no consultation or inquiry before the intended use, our customer shall be solely responsible for the use.
- Specifications of any and all SANYO Semiconductor Co.,Ltd. products described or contained herein stipulate the performance, characteristics, and functions of the described products in the independent state, and are not guarantees of the performance, characteristics, and functions of the described products as mounted in the customer's products or equipment. To verify symptoms and states that cannot be evaluated in an independent device, the customer should always evaluate and test devices mounted in the customer's products or equipment.
- SANYO Semiconductor Co.,Ltd. assumes no responsibility for equipment failures that result from using products at values that exceed, even momentarily, rated values (such as maximum ratings, operating condition ranges, or other parameters) listed in products specifications of any and all SANYO Semiconductor Co.,Ltd. products described or contained herein.
- SANYO Semiconductor Co.,Ltd. strives to supply high-quality high-reliability products, however, any and all semiconductor products fail or malfunction with some probability. It is possible that these probabilistic failures or malfunction could give rise to accidents or events that could endanger human lives, trouble that could give rise to smoke or fire, or accidents that could cause damage to other property. When designing equipment, adopt safety measures so that these kinds of accidents or events cannot occur. Such measures include but are not limited to protective circuits and error prevention circuits for safe design, redundant design, and structural design.
- In the event that any or all SANYO Semiconductor Co.,Ltd. products described or contained herein are controlled under any of applicable local export control laws and regulations, such products may require the export license from the authorities concerned in accordance with the above law.
- No part of this publication may be reproduced or transmitted in any form or by any means, electronic or mechanical, including photocopying and recording, or any information storage or retrieval system, or otherwise, without the prior written consent of SANYO Semiconductor Co.,Ltd.
- Any and all information described or contained herein are subject to change without notice due to product/technology improvement, etc. When designing equipment, refer to the "Delivery Specification" for the SANYO Semiconductor Co.,Ltd. product that you intend to use.
- Upon using the technical information or products described herein, neither warranty nor license shall be granted with regard to intellectual property rights or any other rights of SANYO Semiconductor Co.,Ltd. or any third party. SANYO Semiconductor Co.,Ltd. shall not be liable for any claim or suits with regard to a third party's intellectual property rights which has resulted from the use of the technical information and products mentioned above.

This catalog provides information as of May, 2012. Specifications and information herein are subject to change without notice.



**Стандарт
Электрон
Связь**

Мы молодая и активно развивающаяся компания в области поставок электронных компонентов. Мы поставляем электронные компоненты отечественного и импортного производства напрямую от производителей и с крупнейших складов мира.

Благодаря сотрудничеству с мировыми поставщиками мы осуществляем комплексные и плановые поставки широчайшего спектра электронных компонентов.

Собственная эффективная логистика и склад в обеспечивает надежную поставку продукции в точно указанные сроки по всей России.

Мы осуществляем техническую поддержку нашим клиентам и предпродажную проверку качества продукции. На все поставляемые продукты мы предоставляем гарантию .

Осуществляем поставки продукции под контролем ВП МО РФ на предприятия военно-промышленного комплекса России , а также работаем в рамках 275 ФЗ с открытием отдельных счетов в уполномоченном банке. Система менеджмента качества компании соответствует требованиям ГОСТ ISO 9001.

Минимальные сроки поставки, гибкие цены, неограниченный ассортимент и индивидуальный подход к клиентам являются основой для выстраивания долгосрочного и эффективного сотрудничества с предприятиями радиоэлектронной промышленности, предприятиями ВПК и научно-исследовательскими институтами России.

С нами вы становитесь еще успешнее!

Наши контакты:

Телефон: +7 812 627 14 35

Электронная почта: sales@st-electron.ru

Адрес: 198099, Санкт-Петербург,
Промышленная ул, дом № 19, литера Н,
помещение 100-Н Офис 331