

50Ω TERMINATION TYPE HIGH POWER SPDT SWITCH

DESCRIPTION

- The CG2176X3 is a pHEMT GaAs MMIC 50Ω termination type high power SPDT (Single Pole Double Throw) switch which was developed for WiMAX and WiFi.

FEATURES

- Control voltage :
VC(H) = 1.8 to 5.0 V (3.0V TYP.)
VC(L) = -0.2 to 0.2 V (0V TYP.)
- Low insertion loss :
L_{ins1} = 0.45 dB TYP. @ f = 2.3 to 2.7 GHz
L_{ins2} = 0.50 dB TYP. @ f = 3.3 to 3.8 GHz
L_{ins3} = 0.55 dB TYP. @ f = 4.9 to 5.85 GHz
- High isolation :
ISL1 = 30 dB TYP. @ f = 2.3 to 2.7 GHz
ISL2 = 25 dB TYP. @ f = 3.3 to 3.8 GHz
ISL3 = 22 dB TYP. @ f = 4.9 to 5.85 GHz
- Power handling :
P_{in(0.5dB)} = +37.5 dBm TYP.
@ VC(H) = 3.0 V, VC(L) = 0 V

PACKAGE

- 6-pin Thin SON (X3) Package
(1.5mm x 1.5mm x 0.37mm)

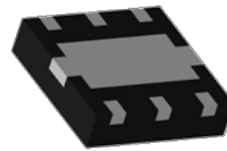

APPLICATIONS

- WiMAX and wireless LAN (IEEE802.11a/b/g/n/ac)

ORDERING INFORMATION

Part Number	Order Number	Package	Marking	Description
CG2176X3	CG2176X3-C2	6-pin plastic TSON (XS03) (Pb-Free)	C05	<ul style="list-style-type: none"> Embossed tape 8 mm wide Pin 1, 6 face the perforation side of the tape MOQ 10 kpcs/reel
CG2176X3-EVAL	CG2176X3-EVAL			<ul style="list-style-type: none"> Evaluation Board with DC block capacitors, power supply bypass capacitors, and RF and DC connectors MOQ 1

PIN CONFIGURATION AND INTERNAL BLOCK DIAGRAM

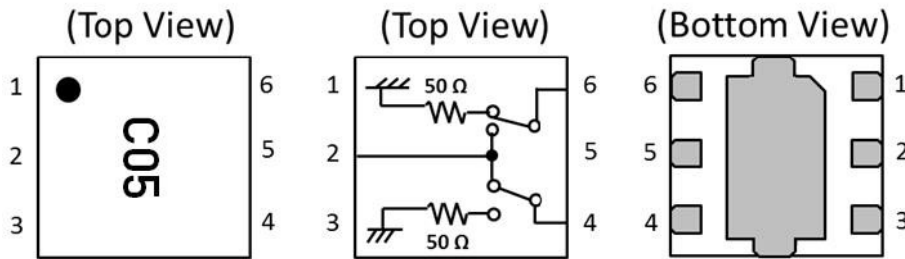

Pin No.	Pin Name
1	VC1
2	RFC
3	VC2
4	RF2
5	GND
6	RF1

Remark Exposed pad : GND

TRUTH TABLE

VC1	VC2	RFC-RF1	RFC-RF2
High	Low	ON	OFF
Low	High	OFF	ON

ABSOLUTE MAXIMUM RATINGS

(TA = +25°C, unless otherwise specified)

Parameter	Symbol	Rating	Unit
Control Voltage	VC	6.0 ^{Note 1}	V
Input Power (ON Port)	P _{in}	+38 ^{Note 2}	dBm
Input Power (OFF Port)	P _{in(off)}	+20	dBm
Operating Ambient Temperature	T _A	-45 ~ +85	°C
Storage Temperature	T _{stg}	-55 ~ +150	°C

- Note**
1. |VC1 - VC2| ≤ 6.0V
 2. 3.0V ≤ |VC1 - VC2| ≤ 5.0V

RECOMMENDED OPERATING RANGE

(TA = +25°C, unless otherwise specified)

Parameter	Symbol	MIN.	TYP.	MAX.	Unit
Operating Frequency	f1	2.3	-	2.7	GHz
	f2	3.3	-	3.8	GHz
	f3	4.9	-	5.85	GHz
Switch Control Voltage (H)	VC(H)	+1.8	+3.0	+5.0	V
Switch Control Voltage (L)	VC(L)	-0.2	0	+0.2	V

ELECTRICAL CHARACTERISTICS

(TA=+25°C, VC(H)=3.0V, VC(L)=0V, Zo=50Ω, DC Block Capacitance=8pF, unless otherwise specified)

Parameter	Symbol	Test Conditions	MIN.	TYP.	MAX.	Unit
Insertion Loss	L _{ins1}	f = 2.3 to 2.7 GHz	-	0.45	0.60	dB
	L _{ins2}	f = 3.3 to 3.8 GHz	-	0.50	0.65	dB
	L _{ins3}	f = 4.9 to 5.85 GHz	-	0.55	0.75	dB
Isolation (RFC – OFF Port)	ISL1	f = 2.3 to 2.7 GHz	27	30	-	dB
	ISL2	f = 3.3 to 3.8 GHz	22	25	-	dB
	ISL3	f = 4.9 to 5.85 GHz	19	22	-	dB
Isolation (RF2 – RF1)	ISL4	f = 2.3 to 2.7 GHz	23	26	-	dB
	ISL5	f = 3.3 to 3.8 GHz	20	23	-	dB
	ISL6	f = 4.9 to 5.85 GHz	17	20	-	dB
Return Loss	RL1	f = 2.3 to 2.7 GHz	12	17	-	dB
	RL2	f = 3.3 to 3.8 GHz	12	17	-	dB
	RL3	f = 4.9 to 5.85 GHz	12	17	-	dB
Unused Port Return Loss	URL1	f = 2.3 to 2.7 GHz	12	17	-	dB
	URL2	f = 3.3 to 3.8 GHz	12	17	-	dB
	URL3	f = 4.9 to 5.85 GHz	12	17	-	dB
0.5 dB Loss Compression Input Power Note	P _{in(0.5 dB)}	f = 2.3 to 2.7 GHz	+35.5	+37.5	-	dBm
		f = 3.3 to 3.8 GHz	+35.5	+37.5	-	dBm
		f = 4.9 to 5.85 GHz	+35.5	+37.5	-	dBm
Error Vector Magnitude	EVM	802.11a, 64QAM, 54Mbps, Pin ≤ +25dBm	-	0.5	-	%
		802.11g, 64QAM, 54Mbps, Pin ≤ +25dBm	-	0.5	-	%
		802.11ac, 256QAM, MCS9, 80MHz, Pin ≤ +25dBm	-	0.5	-	%
Switch Control Current	I _{cont}	RF None	-	16	30	μA
Switch Control Speed	t _{sw}	50% CTL to 90/10% RF	-	100	250	ns

Note P_{in(0.5dB)} is the measured input power level when the insertion loss increases 0.5dB more than that of the linear range.

ELECTRICAL CHARACTERISTICS 2

(TA=+25°C, VC(H)=1.8V, VC(L)=0V, Zo=50Ω, DC Block Capacitance=8pF, unless otherwise specified)

Parameter	Symbol	Test Conditions	MIN.	TYP.	MAX.	Unit
Insertion Loss	L _{ins1}	f = 2.3 to 2.7 GHz	-	0.45	0.60	dB
	L _{ins2}	f = 3.3 to 3.8 GHz	-	0.50	0.65	dB
	L _{ins3}	f = 4.9 to 5.85 GHz	-	0.55	0.75	dB
Isolation (RFC – OFF Port)	ISL1	f = 2.3 to 2.7 GHz	27	30	-	dB
	ISL2	f = 3.3 to 3.8 GHz	22	25	-	dB
	ISL3	f = 4.9 to 5.85 GHz	19	22	-	dB
Isolation (RF2 – RF1)	ISL4	f = 2.3 to 2.7 GHz	23	26	-	dB
	ISL5	f = 3.3 to 3.8 GHz	20	23	-	dB
	ISL6	f = 4.9 to 5.85 GHz	17	20	-	dB
Return Loss	RL1	f = 2.3 to 2.7 GHz	12	17	-	dB
	RL2	f = 3.3 to 3.8 GHz	12	17	-	dB
	RL3	f = 4.9 to 5.85 GHz	12	17	-	dB
Unused Port Return Loss	URL1	f = 2.3 to 2.7 GHz	12	17	-	dB
	URL2	f = 3.3 to 3.8 GHz	12	17	-	dB
	URL3	f = 4.9 to 5.85 GHz	12	17	-	dB
0.5 dB Loss Compression Input Power Note	P _{in(0.5 dB)}	f = 2.3 to 2.7 GHz	+35.5	+37.5	-	dBm
		f = 3.3 to 3.8 GHz	+34.0	+36.0	-	dBm
		f = 4.9 to 5.85 GHz	+34.0	+36.0	-	dBm
Switch Control Current	I _{cont}	RF None	-	12	24	μA
Switch Control Speed	t _{sw}	50% CTL to 90/10% RF	-	250	500	ns

Note P_{in(0.5dB)} is the measured input power level when the insertion loss increases 0.5dB more than that of the linear range.

TYPICAL CHARACTERISTICS

(VC(H)=3V, VC(L)=0V, T_A = +25°C, DC Block Capacitance=8pF, through board loss is subtracted in insertion loss data)

Typical Insertion Loss vs. Frequency

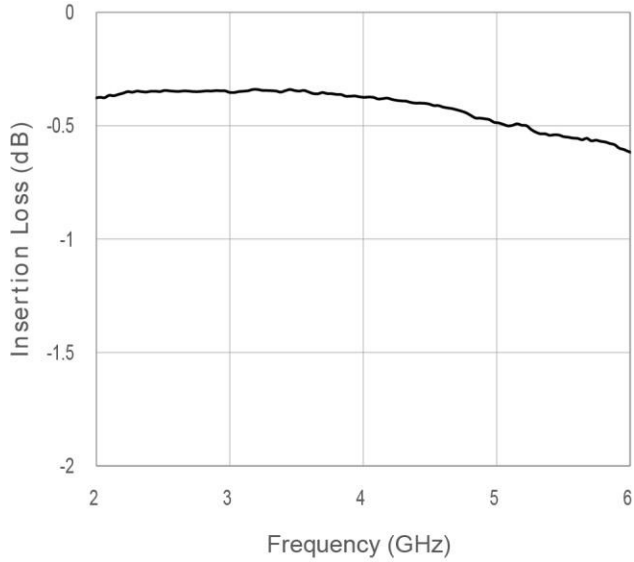

Typical Isolation vs. Frequency

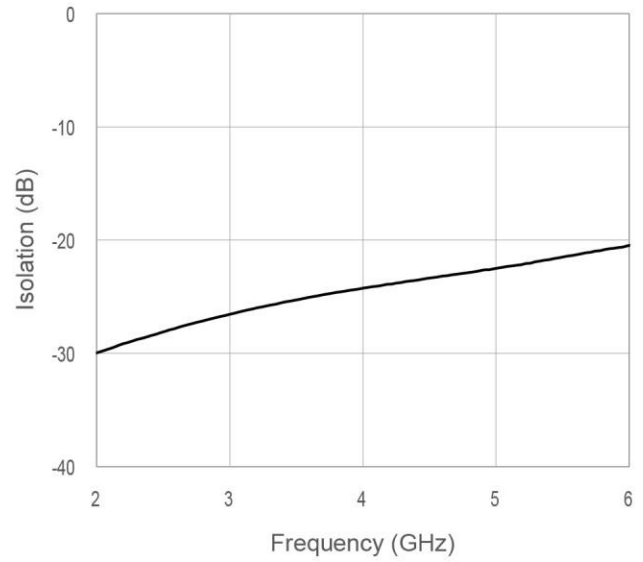

Typical Return Loss vs. Frequency

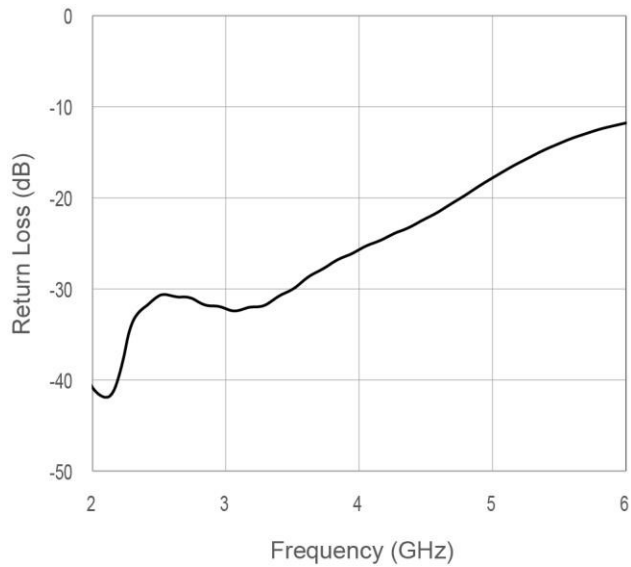

Typical Insertion Loss vs. Input Power

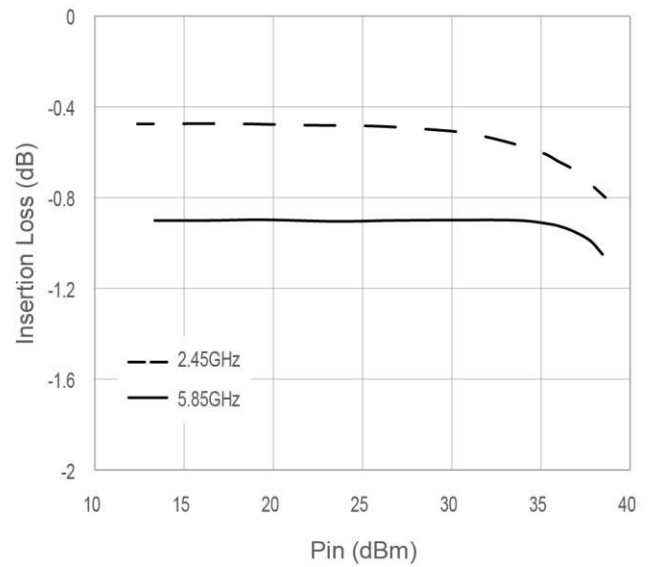

EVALUATION CIRCUIT

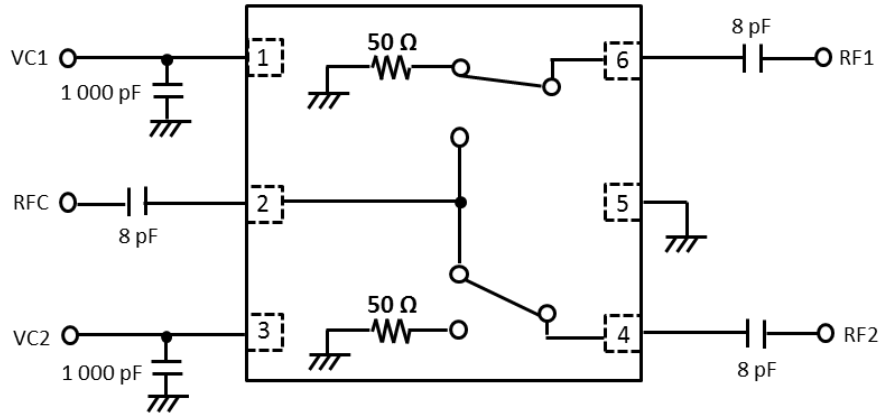

The application circuits and their parameters are for reference only and are not intended for use in actual designs. DC Blocking Capacitors are required at all RF ports.

PACKAGE DIMENSIONS

6-pin Plastic TSON (XS03) (Unit: mm)

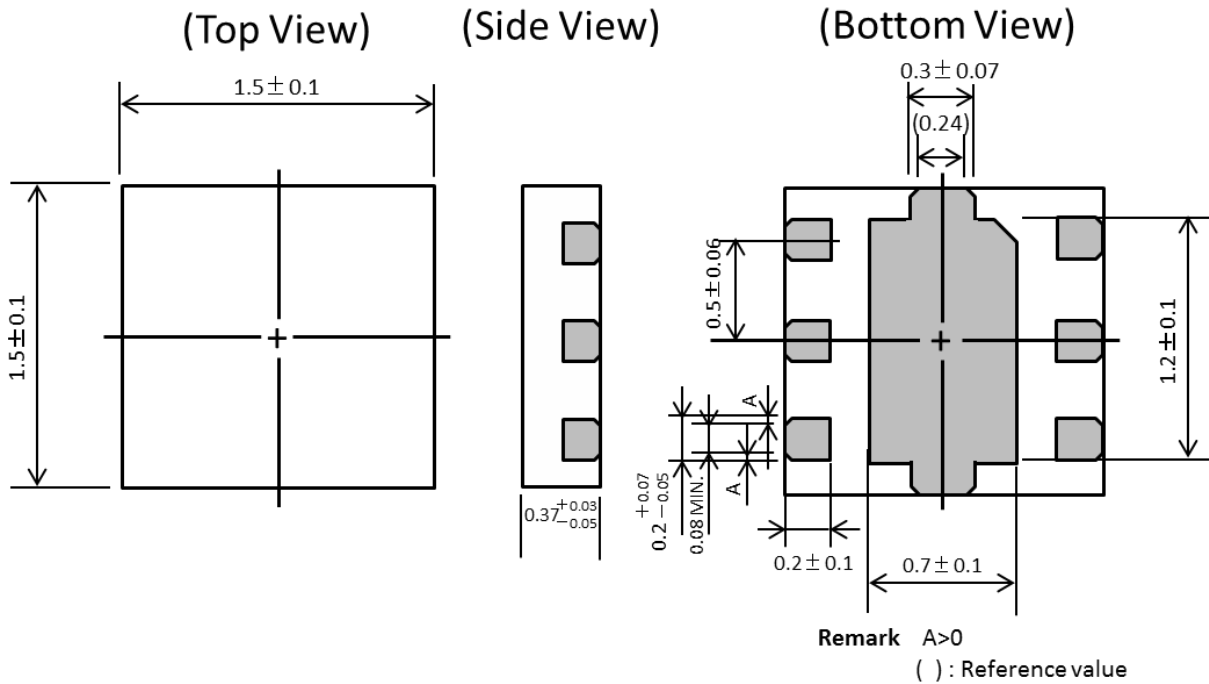

PCB Layout Footprint

6-pin TSON (Unit : mm)

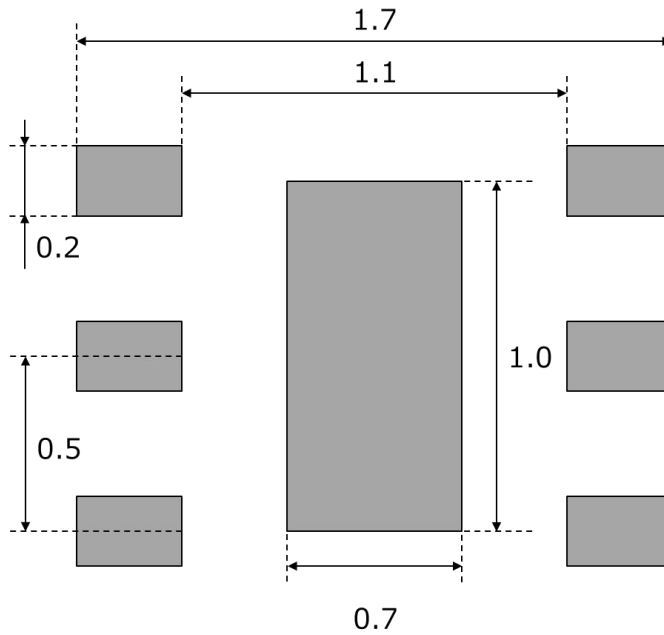

The PCB Layout Footprint in this document is for reference only.

RECOMMENDED SOLDERING CONDITIONS

Recommended Soldering Conditions are available on CEL's [Part Summary page](#) under Associated Documents

REVISION HISTORY

Version	Change to current version	Page(s)
CDS-0014-09 (Issue A) February 17, 2016	Initial datasheet	N/A
CDS-0014-09 (Issue B) March 24, 2016	Added Eval Board ordering information Updated Marking information	1, 2
CDS-0014-10 (Issue C) March 31, 2016	Updated Max Insertion Loss $f = 4.9$ to 5.85 GHz, from 0.70 dB to 0.75 dB	3
CDS-0014-10 (Issue D) August 11, 2016	Removed "preliminary"	All
CDS-0014-10 (Issue E) January 11, 2017	Revised Electrical Characteristics table Added "Recommended Soldering Conditions" section	3, 5
CDS-0014-11 (Issue F) June 20, 2017	Revised Absolute Maximum Ratings table	2
CDS-0014-12 (Issue G) August 29, 2017	Added Error Vector Magnitude parameter to Electrical Characteristics table Added Package Dimensional Tolerance Added Typical Characteristics graphs section	3, 4, 5
CDS-0014-13 (Issue H) Nov 20, 2018	Added Electrical Characteristics table 2 Added PCB Layout Footprint	4,6

[CAUTION]

- All information included in this document is current as of the date this document is issued. Such information, however, is subject to change without any prior notice.
- You should not alter, modify, copy, or otherwise misappropriate any CEL product, whether in whole or in part.
- CEL does not assume any liability for infringement of patents, copyrights, or other intellectual property rights of third parties by or arising from the use of CEL products or technical information described in this document. No license, expressed, implied or otherwise, is granted hereby under any patents, copyrights or other intellectual property rights of CEL or others.
- Descriptions of circuits, software and other related information in this document are provided only to illustrate the operation of semiconductor products and application examples. You are fully responsible for the incorporation of these circuits, software, and information in the design of your equipment. CEL assumes no responsibility for any losses incurred by you or third parties arising from the use of these circuits, software, or information.
- CEL has used reasonable care in preparing the information included in this document, but CEL does not warrant that such information is error free. CEL assumes no liability whatsoever for any damages incurred by you resulting from errors in or omissions from the information included herein.
- Although CEL endeavors to improve the quality and reliability of its products, semiconductor products have specific characteristics such as the occurrence of failure at a certain rate and malfunctions under certain use conditions. Please be sure to implement safety measures to guard them against the possibility of physical injury, and injury or damage caused by fire in the event of the failure of a CEL product, such as safety design for hardware and software including but not limited to redundancy, fire control and malfunction prevention, appropriate treatment for aging degradation or any other appropriate measures
Because the evaluation of microcomputer software alone is very difficult, please evaluate the safety of the final products or system manufactured by you.
- Please use CEL products in compliance with all applicable laws and regulations that regulate the inclusion or use of controlled substances, including without limitation, the EU RoHS Directive.
CEL assumes no liability for damages or losses occurring as a result of your noncompliance with applicable laws and regulations.
- This document may not be reproduced or duplicated, in any form, in whole or in part, without prior written consent of CEL.
- Please contact CEL if you have any questions regarding the information contained in this document or CEL products, or if you have any other inquiries.

[CAUTION]

This product uses gallium arsenide (GaAs) of the toxic substance appointed in laws and ordinances. GaAs vapor and powder are hazardous to human health if inhaled or ingested.

- Do not dispose in fire or break up this product.
- Do not chemically make gas or powder with this product.
- When discarding this product, please obey the laws of your country.
- Do not lick the product or in any way allow it to enter the mouth.

[CAUTION]

Although this device is designed to be as robust as possible, ESD (Electrostatic Discharge) can damage this device. This device must be protected at all times from ESD. Static charges may easily produce potentials of several kilovolts on the human body or equipment, which can discharge without detection. Industry-standard ESD precautions should be used at all times.

CEL Headquarters • 4590 Patrick Henry Drive • Santa Clara, CA 95054 • Tel: (408) 919-2500 • www.cel.com

For a complete list of sales offices, representatives and distributors,

Please visit our website: www.cel.com/contactus

For inquiries email us at rhw@cel.com



Стандарт Электрон Связь

Мы молодая и активно развивающаяся компания в области поставок электронных компонентов. Мы поставляем электронные компоненты отечественного и импортного производства напрямую от производителей и с крупнейших складов мира.

Благодаря сотрудничеству с мировыми поставщиками мы осуществляем комплексные и плановые поставки широчайшего спектра электронных компонентов.

Собственная эффективная логистика и склад в обеспечивает надежную поставку продукции в точно указанные сроки по всей России.

Мы осуществляем техническую поддержку нашим клиентам и предпродажную проверку качества продукции. На все поставляемые продукты мы предоставляем гарантию .

Осуществляем поставки продукции под контролем ВП МО РФ на предприятия военно-промышленного комплекса России , а также работаем в рамках 275 ФЗ с открытием отдельных счетов в уполномоченном банке. Система менеджмента качества компании соответствует требованиям ГОСТ ISO 9001.

Минимальные сроки поставки, гибкие цены, неограниченный ассортимент и индивидуальный подход к клиентам являются основой для выстраивания долгосрочного и эффективного сотрудничества с предприятиями радиоэлектронной промышленности, предприятиями ВПК и научно-исследовательскими институтами России.

С нами вы становитесь еще успешнее!

Наши контакты:

Телефон: +7 812 627 14 35

Электронная почта: sales@st-electron.ru

Адрес: 198099, Санкт-Петербург,
Промышленная ул, дом № 19, литера Н,
помещение 100-Н Офис 331