

| ITEM | Q'TY | PART NUMBER | PART DESCRIPTION |
|------|------|-------------|--|
| 1 | 1 | MPR3 | Chrome Panel Mount Holder, 3mm |
| 2 | 1 | 3XX-F | T-1 (3mm) Flanged LED, See Following Pages |

| REV. | DESCRIPTION | DATE | APPROVED |
|------|-------------------------------------|----------|----------|
| A | Engineering Release. | 10/31/03 | M. C. |
| B | Engineering Update w/o Changes. | 04/07/05 | M. C. |
| C | Dimension Update | 07/10/06 | M. C. |
| D | Updated Specs | 04/03/09 | T. Y. |
| E | Updated Specs | 04/26/12 | T. Y. |
| F | Updated LED offering | 05/03/12 | T. Y. |
| G | Updated Bi-Color Polarity Table | 12/18/12 | T. Y. |
| H | Updated LED Optical Characteristics | 09/15/15 | J. C. |

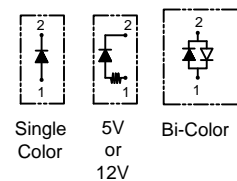
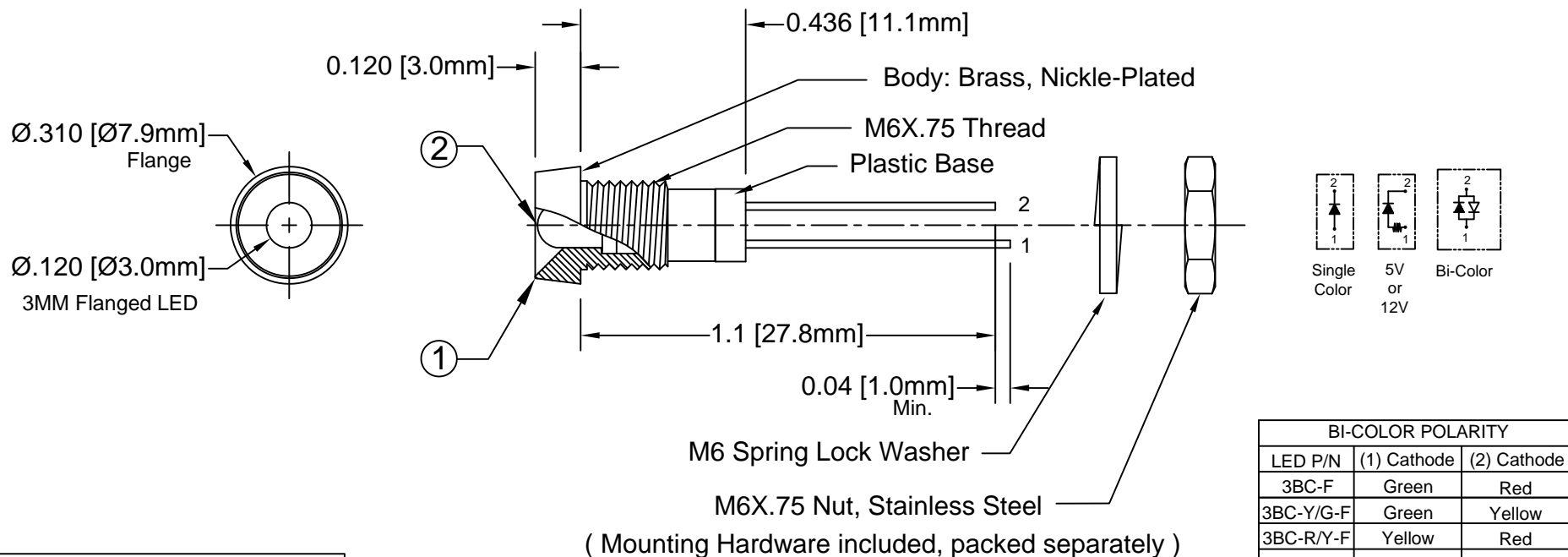

| BI-COLOR POLARITY | | |
|-------------------|-------------|-------------|
| LED P/N | (1) Cathode | (2) Cathode |
| 3BC-F | Green | Red |
| 3BC-Y/G-F | Green | Yellow |
| 3BC-R/Y-F | Yellow | Red |
| 3BC-A/G-F | Green | Amber |

(Mounting Hardware included, packed separately)

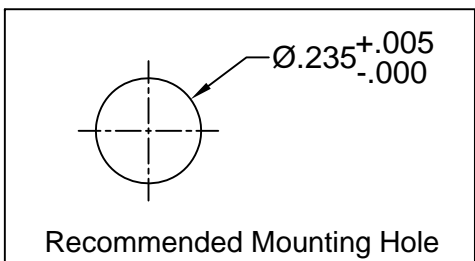



ABSOLUTE MAXIMUM RATINGS (Ta = 25°C)

| | | |
|--|-------|---------------------|
| REVERSE VOLTAGE | _____ | 5V |
| REVERSE CURRENT (VR=5V) | _____ | 100µA |
| OPERATING TEMPERATURE RANGE | _____ | -25°C ~ 85°C |
| STORAGE TEMPERATURE | _____ | -30°C ~ 100°C |
| LEAD SOLDERING TEMPERATURE (1/16" FROM BODY) | _____ | 260°C for 5 Seconds |

| STANDARD TOLERANCE (UNLESS OTHERWISE SPECIFIED) | | 4 THOMAS, IRVINE, CA. 92618 TEL: (949) 951-8808 FAX: (949) 951-3974 |
|--|--------------------------|--|
| DECIMALS | ANGULAR | |
| .X ± .1 | X° ± 1° | TITLE: STD METAL PANEL MOUNT INDICATORS PART NO: MPR3XX CAGE CODE : 32559 SHEET # 1 OF 4 CAD GENERATED DOCUMENT. DO NOT MEASURE DRAWING. |
| .XX ± .02 | | |
| .XXX ± .010 | | |
| DESIGNED: David Green | DATE: 02/14/03 | REVISION: H |
| CHECKED: M. Chen | DATE: 02/14/03 | |

| | | | |
|------|---------------|------|----------|
| REV. | DESCRIPTION | DATE | APPROVED |
| | SEE SHEET #1. | | |

| LED Assy. No. | Chip | | | Lens Appearance | Electro-Optical Data @ 20mA | | | | Viewing Angle 2 θ ½ (Deg) | LED P/N | |
|---------------|-----------|------------------|---------------|-----------------|-----------------------------|--------|-----|----------|---------------------------------|-----------|-----|
| | Material | Peak Wave Length | Emitted Color | | If (mA) | Vf (V) | | Iv (mcd) | | | |
| | | | | | | MAX | TYP | MAX | | | TYP |
| MPR3BWC | GaN/SiC | 430 | BLUE | WATER CLEAR | 25 | 4 | 4.5 | 15 | 20 | 3BWC-F | |
| MPR3BWD | GaN/SiC | 430 | BLUE | DIFFUSED | 25 | 4 | 4.5 | 10 | 35 | 3BWD-F | |
| MPR3BWT | GaN/SiC | 430 | BLUE | TINTED | 25 | 4 | 4.5 | 15 | 20 | 3BWT-F | |
| MPR3GC | GaP/GaP | 568 | GREEN | WATER CLEAR | 30 | 2.1 | 2.8 | 40 | 20 | 3GC-F | |
| MPR3GD | GaP/GaP | 568 | GREEN | DIFFUSED | 30 | 2.1 | 2.8 | 25 | 35 | 3GD-F | |
| MPR3GT | GaP/GaP | 568 | GREEN | TINTED | 30 | 2.1 | 2.8 | 40 | 20 | 3GT-F | |
| MPR3PGC | GaP/GaP | 555 | PURE GREEN | WATER CLEAR | 30 | 2.2 | 2.8 | 10 | 20 | 3PGC-F | |
| MPR3PGD | GaP/GaP | 555 | PURE GREEN | DIFFUSED | 30 | 2.2 | 2.8 | 5 | 35 | 3PGD-F | |
| MPR3PGT | GaP/GaP | 555 | PURE GREEN | TINTED | 30 | 2.2 | 2.8 | 10 | 20 | 3PGT-F | |
| MPR3YC | GaAsP/GaP | 590 | YELLOW | WATER CLEAR | 30 | 2 | 2.8 | 40 | 20 | 3YC-F | |
| MPR3YD | GaAsP/GaP | 590 | YELLOW | DIFFUSED | 30 | 2 | 2.8 | 20 | 35 | 3YD-F | |
| MPR3YT | GaAsP/GaP | 590 | YELLOW | TINTED | 30 | 2 | 2.8 | 40 | 20 | 3YT-F | |
| MPR3AC | GaAsP/GaP | 605 | AMBER | WATER CLEAR | 30 | 2 | 2.8 | 40 | 20 | 3AC-F | |
| MPR3AD | GaAsP/GaP | 605 | AMBER | DIFFUSED | 30 | 2 | 2.8 | 25 | 35 | 3AD-F | |
| MPR3AT | GaAsP/GaP | 605 | AMBER | TINTED | 30 | 2 | 2.8 | 40 | 20 | 3AT-F | |
| MPR3HC | GaAsP/GaP | 625 | HE RED | WATER CLEAR | 30 | 2 | 2.8 | 50 | 20 | 3HC-F | |
| MPR3HD | GaAsP/GaP | 625 | HE RED | DIFFUSED | 30 | 2 | 2.8 | 30 | 35 | 3HD-F | |
| MPR3HT | GaAsP/GaP | 625 | HE RED | TINTED | 30 | 2 | 2.8 | 50 | 20 | 3HT-F | |
| MPR3RC | GaP/GaP | 700 | RED | WATER CLEAR | 20 | 2.1 | 2.8 | 2.5 | 35 | 3RC-F | |
| MPR3RD | GaP/GaP | 700 | RED | DIFFUSED | 20 | 2.1 | 2.8 | 2 | 20 | 3RD-F | |
| MPR3RT | GaP/GaP | 700 | RED | TINTED | 20 | 2.1 | 2.8 | 2.5 | 20 | 3RT-F | |
| MPR3BC-A/G | GaAsP/GaP | 605 | AMBER | DIFFUSED | 30 | 2.0 | 2.8 | 6 | 45 | 3BC-A/G-F | |
| | GaP/GaP | 568 | GREEN | | 30 | 2.1 | 2.8 | 6 | | | |
| MPR3BC | GaAsP/GaP | 625 | RED | DIFFUSED | 30 | 2.0 | 2.8 | 6 | 45 | 3BC-F | |
| | GaP/GaP | 568 | GREEN | | 30 | 2.1 | 2.8 | 6 | | | |
| MPR3BC-R/Y | GaAsP/GaP | 625 | RED | DIFFUSED | 30 | 2.0 | 2.8 | 6 | 45 | 3BC-R/Y-F | |
| | GaAsP/GaP | 590 | YELLOW | | 30 | 2.0 | 2.8 | 4 | | | |
| MPR3BC-Y/G | GaAsP/GaP | 590 | YELLOW | DIFFUSED | 30 | 2.0 | 2.8 | 4 | 45 | 3BC-Y/G-F | |
| | GaP/GaP | 568 | GREEN | | 30 | 2.1 | 2.8 | 6 | | | |

| | | | |
|---|--------------------------|--|-----------------------|
| STANDARD TOLERANCE (UNLESS OTHERWISE SPECIFIED) ±10% ALL VALUES ANGULAR X° ± 5° | |  4 THOMAS, IRVINE, CA. 92618 TEL: (949) 951-8808 FAX: (949) 951-3974 | |
|  | | | |
| DESIGNED: David Green | DATE: 02/14/03 | PART NO: MPR3XX | REVISION: H |
| CHECKED: M. Chen | DATE: 02/14/03 | CAGE CODE : 32559 | SHEET # 2 OF 4 |
| CAD GENERATED DOCUMENT. DO NOT MEASURE DRAWING. | | | |

| | | | |
|------|---------------|------|----------|
| REV. | DESCRIPTION | DATE | APPROVED |
| | SEE SHEET #1. | | |

| LED Assy. No. | Chip | | | Lens Appearance | Electro-Optical Data @ 20mA | | | | Viewing Angle 2 θ ½ (Deg) | LED P/N | |
|---------------|----------------|------------------|---------------|-----------------|-----------------------------|--------|-----|----------|---------------------------------|--------------|-----|
| | Material | Peak Wave Length | Emitted Color | | If (mA) | Vf (V) | | Iv (mcd) | | | |
| | | | | | | MAX | TYP | MAX | | | TYP |
| MPR3UBWC | GaN/SiC | 470 | BLUE | WATER CLEAR | 30 | 4 | 4.5 | 400 | 30 | 3UBWC-0.6K-F | |
| MPR3SGC | GaP/GaP | 568 | GREEN | WATER CLEAR | 30 | 2.1 | 2.8 | 50 | 20 | 3SGC-F | |
| MPR3SGD | GaP/GaP | 568 | GREEN | DIFFUSED | 30 | 2.1 | 2.8 | 30 | 35 | 3SGD-F | |
| MPR3SGT | GaP/GaP | 568 | GREEN | TINTED | 30 | 2.1 | 2.8 | 50 | 20 | 3SGT-F | |
| MPR3SYC | GaAsP/GaP | 590 | YELLOW | WATER CLEAR | 30 | 2.0 | 2.8 | 50 | 20 | 3SYC-F | |
| MPR3SYD | GaAsP/GaP | 590 | YELLOW | DIFFUSED | 30 | 2.0 | 2.8 | 30 | 35 | 3SYD-F | |
| MPR3SYT | GaAsP/GaP | 590 | YELLOW | TINTED | 30 | 2.0 | 2.8 | 50 | 20 | 3SYT-F | |
| MPR3SAC | AlGaInP | 605 | AMBER | WATER CLEAR | 30 | 1.8 | 2.4 | 300 | 20 | 3SAC-F | |
| MPR3SAD | AlGaInP | 605 | AMBER | DIFFUSED | 30 | 1.8 | 2.4 | 100 | 35 | 3SAD-F | |
| MPR3SAT | AlGaInP | 605 | AMBER | TINTED | 30 | 1.8 | 2.4 | 300 | 20 | 3SAT-F | |
| MPR3SRC | GaAlAs/GaAs | 645 | SUPER RED | WATER CLEAR | 30 | 1.7 | 2.4 | 60 | 20 | 3SRC-F | |
| MPR3SRD | GaAlAs/GaAs | 645 | SUPER RED | DIFFUSED | 30 | 1.7 | 2.4 | 40 | 35 | 3SRD-F | |
| MPR3SRT | GaAlAs/GaAs | 645 | SUPER RED | TINTED | 30 | 1.7 | 2.4 | 60 | 20 | 3SRT-F | |
| MPR3UGC | AlGaInP | 570 | GREEN | WATER CLEAR | 30 | 2.1 | 2.4 | 200 | 20 | 3UGC-F | |
| MPR3UGC | AlGaInP | 570 | GREEN | WATER CLEAR | 30 | 2.1 | 2.4 | 300 | 35 | 3UGC-F | |
| MPR3UYC | AlGaInP | 590 | YELLOW | WATER CLEAR | 30 | 2.0 | 2.4 | 300 | 20 | 3UYC-F | |
| MPR3SUYC | AlGaInP | 590 | YELLOW | WATER CLEAR | 30 | 2.0 | 2.4 | 400 | 20 | 3SUYC-F | |
| MPR3UUYC | AlGaInP | 590 | YELLOW | WATER CLEAR | 30 | 2.0 | 2.4 | 600 | 35 | 3UUYC-F | |
| MPR3UOC | AlGaInP | 625 | ORANGE | WATER CLEAR | 30 | 1.8 | 2.4 | 300 | 20 | 3UOC-F | |
| MPR3SUOC | AlGaInP | 625 | ORANGE | WATER CLEAR | 30 | 1.8 | 2.4 | 400 | 20 | 3SUOC-F | |
| MPR3URC | GaAlAs/GaAs | 645 | RED | WATER CLEAR | 30 | 1.7 | 2.4 | 200 | 35 | 3URC-F | |
| MPR3SURC | AlGaInP | 640 | RED | WATER CLEAR | 30 | 1.8 | 2.4 | 200 | 20 | 3SURC-F | |
| MPR3UWC | InGaN/Sapphire | 6500K | WHITE | WATER CLEAR | 30 | 3.2 | 3.6 | 6000 | 35 | 3UWC1.035C-F | |

| | | | | |
|---|--|--------------------------|--|---|
| STANDARD TOLERANCE (UNLESS OTHERWISE SPECIFIED) ±10% ALL VALUES | | ANGULAR X° ± 5° | |  4 THOMAS, IRVINE, CA. 92618 TEL: (949) 951-8808 FAX: (949) 951-3974 |
| DESIGNED: David Green | | DATE: 02/14/03 | | |
| CHECKED: M. Chen | | DATE: 02/14/03 | | PART NO: MPR3XX |
| | | | | REVISION: H |
| | | | | CAGE CODE : 32559 SHEET # 3 OF 4 |
| CAD GENERATED DOCUMENT. DO NOT MEASURE DRAWING. | | | | |

| | | | |
|------|---------------|------|----------|
| REV. | DESCRIPTION | DATE | APPROVED |
| | SEE SHEET #1. | | |

| LED Assy. No. | Chip | | | Lens Appearance | Absolute Max. Ratings | | | Electro-Optical Data @ 2mA | | | Viewing Angle 2 θ ½ (Deg) | LED P/N |
|---------------|-------------|-------------------------|---------------|-----------------|-----------------------|---------|-------------|----------------------------|-----|----------|---------------------------|---------|
| | Material | Peak Wave Length λp(nm) | Emitted Color | | Pd (mW) | If (mA) | Peak If(mA) | Vf (V) | | Iv (mcd) | | |
| | | | | | | | | TYP | MAX | TYP | | |
| MPR3BWDL | GaN/siC | 430 | BLUE | DIFFUSED | 20 | 7 | - | 3.8 | 4.2 | 2.5 | 35 | 3BWDL-F |
| MPR3GDL | GaP/GaP | 568 | GREEN | DIFFUSED | 10 | 7 | - | 2.1 | 2.6 | 4.0 | 35 | 3GDL-F |
| MPR3PGDL | GaP/GaP | 555 | PURE GREEN | DIFFUSED | 10 | 7 | - | 2.1 | 2.6 | 0.2 | 35 | 3PGDL-F |
| MPR3YDL | GaAsP/GaP | 590 | YELLOW | DIFFUSED | 10 | 7 | - | 2.0 | 2.6 | 2.0 | 35 | 3YDL-F |
| MPR3ADL | GaAsP/GaP | 605 | AMBER | DIFFUSED | 10 | 7 | - | 2.0 | 2.6 | 4.0 | 35 | 3ADL-F |
| MPR3HDL | GaAsP/GaP | 625 | HE RED | DIFFUSED | 10 | 7 | - | 2.0 | 2.6 | 2.5 | 35 | 3HDL-F |
| MPR3RDL | GaP/GaP | 700 | RED | DIFFUSED | 10 | 7 | - | 2.1 | 2.6 | 0.5 | 35 | 3RDL-F |
| MPR3SRDL | GaAlAs/GaAs | 645 | RED | DIFFUSED | 10 | 7 | - | 2.0 | - | 8.0 | 35 | 3SRDL-F |

| LED Assy. No. | Peak Wave Length λp(nm) | Emitted Color | Lens Appearance | Electro-Optical Data | | | | Viewing Angle 2 θ½ (Deg) | LED P/N |
|----------------|-------------------------|---------------|-----------------|----------------------|--------|-----|----------|--------------------------|----------|
| | | | | If (mA) | Vf (V) | | Iv (mcd) | | |
| | | | | | MAX | TYP | | | |
| 5 Volt | | | | Data @ 5V | | | | | |
| MPR3BWD5V | BLUE | 430 | DIFFUSED | - | - | 5 | 10 | 35 | 3BWD5V-F |
| MPR3GC5V | GREEN | 568 | WATER CLEAR | - | - | 5 | 40 | 20 | 3GC5V-F |
| MPR3GD5V | GREEN | 568 | DIFFUSED | - | - | 5 | 25 | 35 | 3GD5V-F |
| MPR3GT5V | GREEN | 568 | TINTED | - | - | 5 | 40 | 20 | 3GT5V-F |
| MPR3AD5V | AMBER | 605 | DIFFUSED | - | - | 5 | 25 | 35 | 3AD5V-F |
| MPR3HD5V | HE RED | 625 | DIFFUSED | - | - | 5 | 30 | 35 | 3HD5V-F |
| MPR3RD5V | RED | 700 | DIFFUSED | - | - | 5 | 2 | 35 | 3RD5V-F |
| MPR3YD5V | YELLOW | 590 | DIFFUSED | - | - | 5 | 20 | 35 | 3YD5V-F |
| 12 Volt | | | | Data @ 12V | | | | | |
| MPR3GC12V | GREEN | 568 | WATER CLEAR | - | - | 12 | 40 | 20 | 3GC12V-F |
| MPR3GD12V | GREEN | 568 | DIFFUSED | - | - | 12 | 25 | 35 | 3GD12V-F |
| MPR3HC12V | HE RED | 625 | WATER CLEAR | - | - | 12 | 50 | 20 | 3HC12V-F |
| MPR3HD12V | HE RED | 625 | DIFFUSED | - | - | 12 | 30 | 35 | 3HD12V-F |
| MPR3RC12V | RED | 700 | WATER CLEAR | - | - | 12 | 6 | 20 | 3RC12V-F |
| MPR3RD12V | RED | 700 | DIFFUSED | - | - | 12 | 2 | 35 | 3RD12V-F |
| MPR3YC12V | YELLOW | 590 | WATER CLEAR | - | - | 12 | 40 | 20 | 3YC12V-F |
| MPR3YD12V | YELLOW | 590 | DIFFUSED | - | - | 12 | 25 | 35 | 3YD12V-F |

| | | | | |
|---|--|--------------------------|--|---|
| STANDARD TOLERANCE (UNLESS OTHERWISE SPECIFIED) ±10% ALL VALUES | | ANGULAR X° ± 5° | |  4 THOMAS, IRVINE, CA. 92618 TEL: (949) 951-8808 FAX: (949) 951-3974 |
| DESIGNED: David Green | | DATE: 02/14/03 | | |
| CHECKED: M. Chen | | DATE: 02/14/03 | | REVISION: H |
| | | CAGE CODE : 32559 | | SHEET # 4 OF 4 CAD GENERATED DOCUMENT. DO NOT MEASURE DRAWING. |



Стандарт Электрон Связь

Мы молодая и активно развивающаяся компания в области поставок электронных компонентов. Мы поставляем электронные компоненты отечественного и импортного производства напрямую от производителей и с крупнейших складов мира.

Благодаря сотрудничеству с мировыми поставщиками мы осуществляем комплексные и плановые поставки широчайшего спектра электронных компонентов.

Собственная эффективная логистика и склад в обеспечивает надежную поставку продукции в точно указанные сроки по всей России.

Мы осуществляем техническую поддержку нашим клиентам и предпродажную проверку качества продукции. На все поставляемые продукты мы предоставляем гарантию .

Осуществляем поставки продукции под контролем ВП МО РФ на предприятия военно-промышленного комплекса России , а также работаем в рамках 275 ФЗ с открытием отдельных счетов в уполномоченном банке. Система менеджмента качества компании соответствует требованиям ГОСТ ISO 9001.

Минимальные сроки поставки, гибкие цены, неограниченный ассортимент и индивидуальный подход к клиентам являются основой для выстраивания долгосрочного и эффективного сотрудничества с предприятиями радиоэлектронной промышленности, предприятиями ВПК и научно-исследовательскими институтами России.

С нами вы становитесь еще успешнее!

Наши контакты:

Телефон: +7 812 627 14 35

Электронная почта: sales@st-electron.ru

Адрес: 198099, Санкт-Петербург,
Промышленная ул, дом № 19, литера Н,
помещение 100-Н Офис 331