

**SERIES 88**

**Sealed, Flange Mounted**

**FEATURES**

- Sealed Keyboard
- Colorful Graphic Overlay
- Audible, Snap-Dome Contact
- User Legendable Styles
- 3,000,000 Operations per Button
- Optional Panel Seal Gasket to Protect Your Equipment



**DIMENSIONS** In inches (and millimeters)

**3x4 Keyboard**

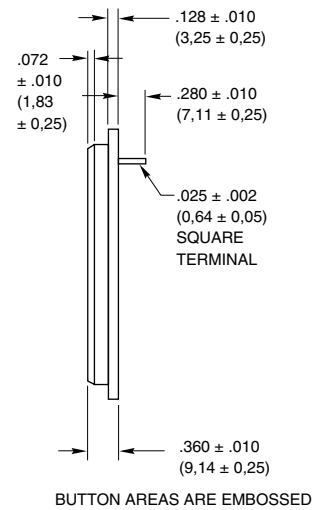

BUTTON AREAS ARE EMBOSSED

**Termination** In inches (and millimeters)

**3x4**

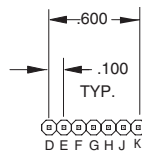
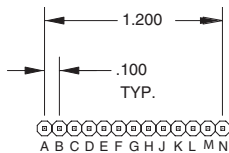
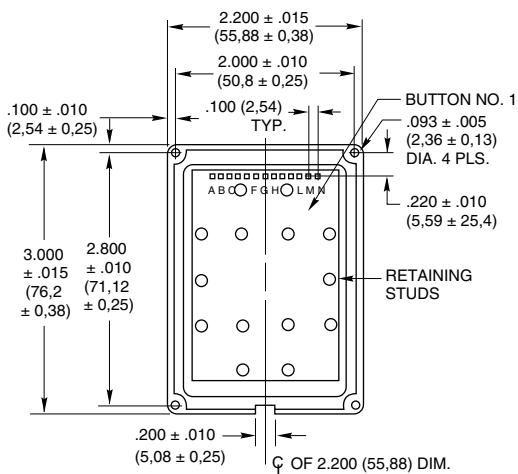

**Code and Truth Table**

Dots in the chart indicate connected terminals when switch is closed. Terminals are identified on the keyboard.

3x4		CODES																					
		Matrix							Single Pole/Common Bus														
BUTTON LOCATION	1	•	•	•	•	•	•	•	•	•	•	•	•	•	•								
	2	•	•	•	•	•	•	•	•	•	•	•	•	•	•								
	3	•	•	•	•	•	•	•	•	•	•	•	•	•	•								
	4	•	•	•	•	•	•	•	•	•	•	•	•	•	•								
	5	•	•	•	•	•	•	•	•	•	•	•	•	•	•								
	6	•	•	•	•	•	•	•	•	•	•	•	•	•	•								
	7	•	•	•	•	•	•	•	•	•	•	•	•	•	•								
	8	•	•	•	•	•	•	•	•	•	•	•	•	•	•								
	9	•	•	•	•	•	•	•	•	•	•	•	•	•	•								
	10	•	•	•	•	•	•	•	•	•	•	•	•	•	•								
	11	•	•	•	•	•	•	•	•	•	•	•	•	•	•								
	12	•	•	•	•	•	•	•	•	•	•	•	•	•	•								
		F	E	D	K	J	H	G	J	E	A	K	F	B	L	G	C	M	H	D	N		
		TERMINAL LOCATION																					



**SERIES 88**  
Sealed, Flange Mounted

**FEATURES**

- Sealed Keyboard
- Colorful Graphic Overlay
- Audible, Snap-Dome Contact
- User Legendable Styles
- 3,000,000 Operations per Button
- Optional Panel Seal Gasket to Protect Your Equipment



**DIMENSIONS** In inches (and millimeters)

**5x4 Keyboard**

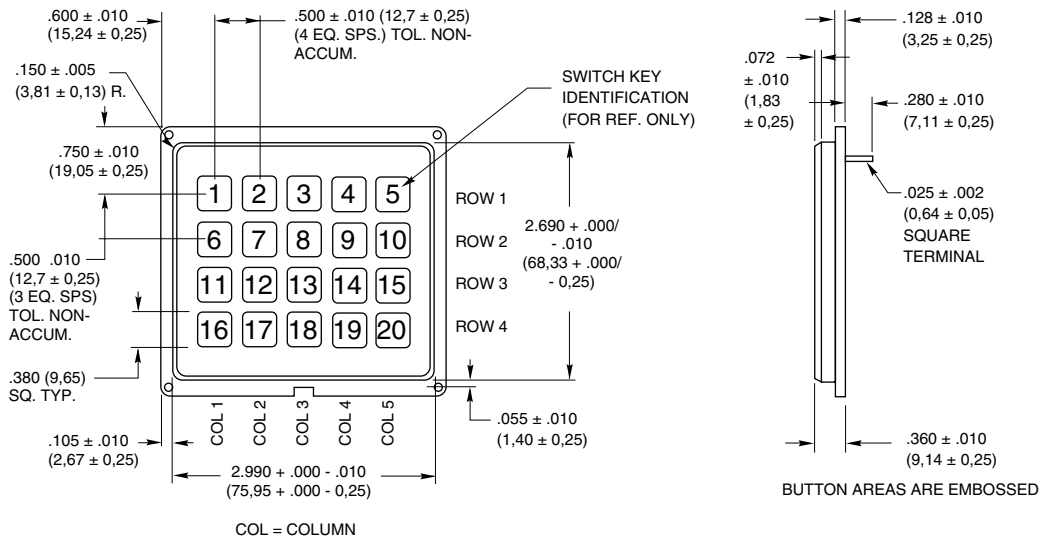

**Termination** In inches (and millimeters)

**5x4 Keyboard**



**Code and Truth Table**

Dots in the chart indicate connected terminals when switch is closed. Terminals are identified on the keyboard.

5x4	CODES	
	Matrix	Single Pole/Common Bus
1	•	•
2	•	•
3	•	•
4	•	•
5	•	•
6	•	•
7	•	•
8	•	•
9	•	•
10	•	•
11	•	•
12	•	•
13	•	•
14	•	•
15	•	•
16	•	•
17	•	•
18	•	•
19	•	•
20	•	•
	P N K G F J L M H	T P M H D U Q L G C V R K F B W S J E A N
	<b>TERMINAL LOCATION</b>	

**SPECIFICATIONS**

**Rating Criteria**

**Rating at 24 Vdc:** 10 milliamps, resistive  
**Contact Resistance:** Compatible with MOS, TTL and DTL (10 ohms maximum)  
**Voltage Breakdown:** 250 Vac between mutually insulated parts  
**Life Expectancy:** 3,000,000 operations per button

**Contact Bounce:** Less than 4 milliseconds at make, 10 milliseconds at break  
**Temperature:** -40°C to +80°C

**Operating Features**

**Button Travel:** 0.015"(0,38 mm) nominal total travel  
**Typical Operating Force:** 350 grams

**Materials and Finishes**

**Housing:** ABS polycarbonate, black  
**Graphic Overlay:** Polyester  
**Contact Dome:** Stainless steel, selectively gold-plated  
**Terminals:** Phosphor bronze

**STANDARD LEGENDS**

Colorful graphic overlays are polyester with a tough acrylic bond to provide maximum protection against dirt and moisture. Second surface printed, the overlay wipes clean and

continues to look bright and bold throughout the keyboard life. Available through distributors. For instant custom legends, order separate blank keyboards as indicated in the Ordering

Information section and choose one of the clear window overlays below; then order a sheet of legend inserts. Or, if you prefer, order the keyboard custom printed by Grayhill; see Ordering Information.



-143



-152



-172

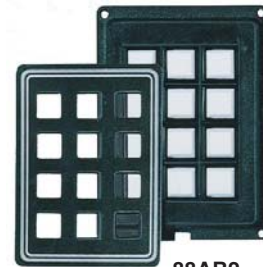

88-101

88AB2,  
88AC2



-052



-072



-082



88-001

88BB2,  
88BC2



-252



-262

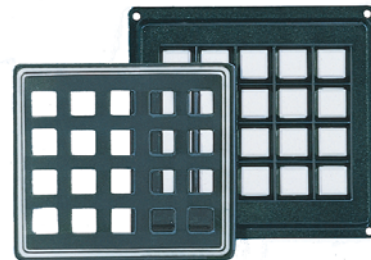

88-201

88JB2, 88JC2

**SEALING OF KEYBOARDS**

The graphic legend is silk-screen printed on the second surface of a clear polyester film, providing maximum legend protection. It withstands high humidity, and it is resistant to scratching, marring, and dulling of the surface caused by fingernails, wiping cloths, and cleaning materials. It has excellent solvent resistance to water, petroleum oil, alcohols and aliphatic hydrocarbons.

These common liquids do not attack the overlay: 5% acetic acid, 5% citric acid, 2%

detergent solution, soapy water, 30% hydrogen peroxide, wine, beer, whiskey, coffee, cocoa, milk, tomato juice, lemon juice, etc. Hydrocarbons, ketones and freon do not affect the overlay. But, we recommend that you do not subject the keyboard to these chemicals, since they may affect the switch housing, which is ABS plastic. To discuss a particular solvent, contact Grayhill.

Protect your equipment in outdoor or harsh environmental conditions by sealing the

keyboard to the equipment panel. Use an optional gasket with the keyboard. There are two types of gaskets: one for mounting the keyboard beneath the panel, and one for mounting it above the equipment panel. See Panel Seal Gaskets.

The contact system is internally sealed by a special adhesive backed sheet that holds the domes in position on the PC board.

**PANEL SEAL GASKETS**

Weatherproof and waterproof your subpanel and topside mounted keyboards with optional panel seal gaskets.

Subpanel keyboard gasket is .062" (1,57 mm) thick; topside keyboard gasket is .094" (2,39 mm).

Material is cellulose fiber, foam, nitrile rubber. Order gaskets separately from keyboard.



- Subpanel 3x4 **Part No. 88M2001-2**
- Subpanel 4x4 **Part No. 88M2009-2**
- Subpanel 5x4 **Part No. 88M2019-1**
  
- Topside 3x4 **Part No. 88M2012-1**
- Topside 4x4 **Part No. 88M2015-1**
- Topside 5x4 **Part No. 88M2018-1**

Size of Keyboard	Subpanel Mount		Topside Mount	
	Dim. A	Dim. B	Dim. C	Dim. D
3x4	2.010 ± .005 (51,05 ± 0,13)	2.400 ± .005 (60,96 ± 0,13)	1.800 ± .005 (45,72 ± 0,13)	2.040 ± .005 (51,82 ± 0,13)
4x4	2.510 ± .005 (63,75 ± 0,13)	2.900 ± .005 (73,66 ± 0,13)	2.300 ± .005 (58,42 ± 0,13)	2.540 ± .005 (64,52 ± 0,13)
5x4	3.010 ± .005 (76,45 ± 0,13)	3.400 ± .005 (86,36 ± 0,13)	2.800 ± .005 (71,12 ± 0,13)	3.040 ± .005 (77,22 ± 0,13)

**INSTANT CUSTOM LEGENDS**

**Available through Distributors**

Create your own legends using these 3 items: 1) a blank keyboard, 2) the clear window overlays shown on Standard Legend page and 3) a sheet of legend inserts.

**Blank Keyboards**

The numbers below order blank keyboards for the user to legend. For description, refer to the part numbering scheme below. The keyboards and overlays are ordered separately.

- 3x4 Matrix **Part No. 88AB2**
- 3x4 SP/Com Bus **Part No. 88AC2**
- 4x4 Matrix **Part No. 88BB2**
- 4x4 SP/Com Bus **Part No. 88BC2**
- 5x4 Matrix **Part No. 88JB2**
- 5x4 SP/Com Bus **Part No. 88JC2**

**Legend Insert Sheet and Dry Transfers**

Self-adhesive inserts are die-cut to fit the

button. Legends are printed in black on clear film in News Gothic Condensed type style. They include letters A through Z, numbers 0-69, telephone legends, commonly used words, symbols and blanks.

**Part No. 87AC2046**

Use matching dry transfer lettering on blank inserts of legend sheet: upper and lower case letters, 0-9, and common symbols.

- Small Print **Part No. 87-DT-2096-088**
- Medium Print **Part No. 87-DT-2096-125**
- Large Print **Part No. 87-DT-2096-187**

**Clear Window Overlays**

Order separately from keyboards. See also ordering information.

- 3x4 Overlay **Part No. 88-101**
- 4x4 Overlay **Part No. 88-001**
- 5x4 Overlay **Part No. 88-201**

**PRINTED LEGENDS**

**Not available through Distributors.** For medium volume applications, or where legends cannot be produced by the self legend method, you can order epoxy ink printed legends. Virtually anything which can be photographed can be printed. Grayhill will print your legend and then add the clear window overlay.

Type I.D. No.	Simulated Style & Size	Character & Line Limitations *
4GH088	ABCDEFGH	END DATA
1GH125	ABCDE	LAD
3GH187	ABCD	ON
2GH250	ABC	15

**ORDERING INFORMATION**

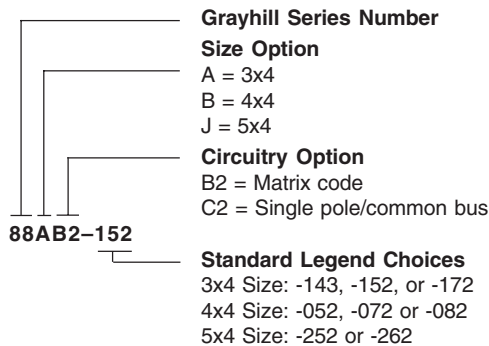

**Available from your local Grayhill Distributor.** For prices and discounts, contact a local Sales Office, an authorized local Distributor or Grayhill.



## Стандарт Электрон Связь

Мы молодая и активно развивающаяся компания в области поставок электронных компонентов. Мы поставляем электронные компоненты отечественного и импортного производства напрямую от производителей и с крупнейших складов мира.

Благодаря сотрудничеству с мировыми поставщиками мы осуществляем комплексные и плановые поставки широчайшего спектра электронных компонентов.

Собственная эффективная логистика и склад в обеспечивает надежную поставку продукции в точно указанные сроки по всей России.

Мы осуществляем техническую поддержку нашим клиентам и предпродажную проверку качества продукции. На все поставляемые продукты мы предоставляем гарантию .

Осуществляем поставки продукции под контролем ВП МО РФ на предприятия военно-промышленного комплекса России , а также работаем в рамках 275 ФЗ с открытием отдельных счетов в уполномоченном банке. Система менеджмента качества компании соответствует требованиям ГОСТ ISO 9001.

Минимальные сроки поставки, гибкие цены, неограниченный ассортимент и индивидуальный подход к клиентам являются основой для выстраивания долгосрочного и эффективного сотрудничества с предприятиями радиоэлектронной промышленности, предприятиями ВПК и научно-исследовательскими институтами России.

С нами вы становитесь еще успешнее!

### Наши контакты:

**Телефон:** +7 812 627 14 35

**Электронная почта:** [sales@st-electron.ru](mailto:sales@st-electron.ru)

**Адрес:** 198099, Санкт-Петербург,  
Промышленная ул, дом № 19, литера Н,  
помещение 100-Н Офис 331