



PIC24HJ32GP302/304, PIC24HJ64GPX02/X04 and PIC24HJ128GPX02/X04

16-bit Microcontrollers (up to 128 KB Flash and 8K SRAM) with Advanced Analog

Operating Conditions

- 3.0V to 3.6V, -40°C to +150°C, DC to 20 MIPS
- 3.0V to 3.6V, -40°C to +125°C, DC to 40 MIPS

Clock Management

- 2% internal oscillator
- Programmable PLL and oscillator clock sources
- Fail-Safe Clock Monitor (FSCM)
- Independent Watchdog Timer
- Low-power management modes
- Fast wake-up and start-up

High-Efficiency Math Engine

- Single-cycle MUL plus hardware divide

Advanced Analog Features

- 10/12-bit ADC with 1.1Msps/500 ksps conversion rate:
 - Up to 13 ADC input channels and four S&H
 - Flexible/Independent trigger sources
- 150 ns Comparators:
 - Up to two Analog Comparator modules
 - 4-bit DAC with two ranges for Analog Comparators

Input/Output

- Software remappable pin functions
- 5V-tolerant pins
- Selectable open drain and internal pull-ups
- Up to 5 mA overvoltage clamp current/pin
- Multiple external interrupts

System Peripherals

- Cyclic Redundancy Check (CRC) module
- Up to five 16-bit and up to two 32-bit Timers/Counters
- Up to four Input Capture (IC) modules
- Up to four Output Compare (OC) modules
- Real-Time Clock and Calendar (RTCC) module

Communication Interfaces

- Parallel Master Port (PMP)
- Two UART modules (10 Mbps)
 - Supports LIN 2.0 protocols
 - RS-232, RS-485, and IrDA[®] support
- Two 4-wire SPI modules (15 Mbps)
- Enhanced CAN (ECAN) module (1 Mbaud) with 2.0B support
- I²C module (100K, 400K and 1Mbaud) with SMBus support

Direct Memory Access (DMA)

- 8-channel hardware DMA with no CPU stalls or overhead
- UART, SPI, ADC, ECAN, IC, OC, INT0

Qualification and Class B Support

- AEC-Q100 REVG (Grade 0 -40°C to +150°C)
- Class B Safety Library, IEC 60730, VDE certified

Debugger Development Support

- In-circuit and in-application programming
- Two program breakpoints
- Trace and run-time watch

Packages

Type	SPDIP	SOIC	QFN-S	QFN	TQFP
Pin Count	28	28	28	44	44
I/O Pins	21	21	21	35	35
Contact Lead/Pitch	.100"	1.27	0.65	0.65	0.80
Dimensions	1.365x.285x.135"	17.9x7.50x2.05	6x6x0.9	8x8x0.9	10x10x1

Note: All dimensions are in millimeters (mm) unless specified.

PIC24HJ32GP302/304, PIC24HJ64GPX02/X04 AND PIC24HJ128GPX02/X04

PIC24HJ32GP302/304, PIC24HJ64GPX02/X04 AND PIC24HJ128GPX02/X04 PRODUCT FAMILIES

The device names, pin counts, memory sizes and peripheral availability of each device are listed below. The following pages show their pinout diagrams.

TABLE 1: PIC24HJ32GP302/304, PIC24HJ64GPX02/X04 AND PIC24HJ128GPX02/X04 CONTROLLER FAMILIES

Device	Pins	Program Flash Memory (Kbyte)	RAM (Kbyte) ⁽¹⁾	Remappable Peripheral								RTCC	I ² C™	CRC Generator	10-bit/12-bit ADC (Channels)	Analog Comparator (2 Channels/Voltage Regulator)	8-bit Parallel Master Port (Address Lines)	I/O Pins	Packages
				Remappable Pins	16-bit Timer ⁽²⁾	Input Capture	Output Compare Standard PWM	UART	SPI	ECAN™	External Interrupts ⁽³⁾								
PIC24HJ128GP504	44	128	8	26	5	4	4	2	2	1	3	1	1	1	13	1/1	11	35	QFN TQFP
PIC24HJ128GP502	28	128	8	16	5	4	4	2	2	1	3	1	1	1	10	1/0	2	21	SPDIP SOIC QFN-S
PIC24HJ128GP204	44	128	8	26	5	4	4	2	2	0	3	1	1	1	13	1/1	11	35	QFN TQFP
PIC24HJ128GP202	28	128	8	16	5	4	4	2	2	0	3	1	1	1	10	1/0	2	21	SPDIP SOIC QFN-S
PIC24HJ64GP504	44	64	8	26	5	4	4	2	2	1	3	1	1	1	13	1/1	11	35	QFN TQFP
PIC24HJ64GP502	28	64	8	16	5	4	4	2	2	1	3	1	1	1	10	1/0	2	21	SPDIP SOIC QFN-S
PIC24HJ64GP204	44	64	8	26	5	4	4	2	2	0	3	1	1	1	13	1/1	11	35	QFN TQFP
PIC24HJ64GP202	28	64	8	16	5	4	4	2	2	0	3	1	1	1	10	1/0	2	21	SPDIP SOIC QFN-S
PIC24HJ32GP304	44	32	4	26	5	4	4	2	2	0	3	1	1	1	13	1/1	11	35	QFN TQFP
PIC24HJ32GP302	28	32	4	16	5	4	4	2	2	0	3	1	1	1	10	1/0	2	21	SPDIP SOIC QFN-S

Note 1: RAM size is inclusive of 2 Kbytes of DMA RAM for all devices except PIC24HJ32GP302/304, which include 1 Kbyte of DMA RAM.

2: Only four out of five timers are remappable.

3: Only two out of three interrupts are remappable.

Pin Diagrams

28-Pin SPDIP, SOIC

■ Pins are up to 5V tolerant



28-Pin QFN-S⁽²⁾

■ Pins are up to 5V tolerant



- Note**
- 1: The RP_x pins can be used by any remappable peripheral. See [Table 1](#) in this section for the list of available peripherals.
 - 2: The metal plane at the bottom of the device is not connected to any pins and is recommended to be connected to VSS externally.
 - 3: Refer to [Section 2.3 “CPU Logic Filter Capacitor Connection \(V_{CAP}\)”](#) for proper connection to this pin.

PIC24HJ32GP302/304, PIC24HJ64GPX02/X04 AND PIC24HJ128GPX02/X04

Pin Diagrams (Continued)

44-Pin QFN⁽²⁾

■ Pins are up to 5V tolerant



- Note** 1: The RPx pins can be used by any remappable peripheral. See [Table 1](#) in this section for the list of available peripherals.
- 2: The metal plane at the bottom of the device is not connected to any pins and is recommended to be connected to VSS externally.
- 3: Refer to [Section 2.3 “CPU Logic Filter Capacitor Connection \(VCAP\)”](#) for proper connection to this pin.

Pin Diagrams (Continued)

44-Pin TQFP

■ Pins are up to 5V tolerant



- Note** 1: The RPx pins can be used by any remappable peripheral. See [Table 1](#) in this section for the list of available peripherals.
 2: Refer to [Section 2.3 “CPU Logic Filter Capacitor Connection \(Vcap\)”](#) for proper connection to this pin.

Table of Contents

PIC24HJ32GP302/304, PIC24HJ64GPX02/X04 and PIC24HJ128GPX02/X04 Product Families	2
1.0 Device Overview	9
2.0 Guidelines for Getting Started with 16-bit Microcontrollers	13
3.0 CPU	17
4.0 Memory Organization	25
5.0 Flash Program Memory	53
6.0 Resets	59
7.0 Interrupt Controller	69
8.0 Direct Memory Access (DMA)	107
9.0 Oscillator Configuration	119
10.0 Power-Saving Features	129
11.0 I/O Ports	135
12.0 Timer1	161
13.0 Timer2/3 And Timer4/5 Feature	165
14.0 Input Capture	171
15.0 Output Compare	175
16.0 Serial Peripheral Interface (SPI)	179
17.0 Inter-Integrated Circuit™ (I ² C™)	185
18.0 Universal Asynchronous Receiver Transmitter (UART)	193
19.0 Enhanced CAN (ECAN™) Module	199
20.0 10-bit/12-bit Analog-to-Digital Converter (ADC1)	227
21.0 Comparator Module	241
22.0 Real-Time Clock and Calendar (RTCC)	247
23.0 Programmable Cyclic Redundancy Check (CRC) Generator	259
24.0 Parallel Master Port (PMP)	265
25.0 Special Features	273
26.0 Instruction Set Summary	283
27.0 Development Support	291
28.0 Electrical Characteristics	295
29.0 High Temperature Electrical Characteristics	345
32.0 DC and AC Device Characteristics Graphs	357
33.0 Packaging Information	361
Appendix A: Revision History	371
The Microchip Web Site	385
Customer Change Notification Service	385
Customer Support	385
Reader Response	386
Product Identification System	387

TO OUR VALUED CUSTOMERS

It is our intention to provide our valued customers with the best documentation possible to ensure successful use of your Microchip products. To this end, we will continue to improve our publications to better suit your needs. Our publications will be refined and enhanced as new volumes and updates are introduced.

If you have any questions or comments regarding this publication, please contact the Marketing Communications Department via E-mail at docerrors@microchip.com or fax the **Reader Response Form** in the back of this data sheet to (480) 792-4150. We welcome your feedback.

Most Current Data Sheet

To obtain the most up-to-date version of this data sheet, please register at our Worldwide Web site at:

<http://www.microchip.com>

You can determine the version of a data sheet by examining its literature number found on the bottom outside corner of any page. The last character of the literature number is the version number, (e.g., DS30000A is version A of document DS30000).

Errata

An errata sheet, describing minor operational differences from the data sheet and recommended workarounds, may exist for current devices. As device/documentation issues become known to us, we will publish an errata sheet. The errata will specify the revision of silicon and revision of document to which it applies.

To determine if an errata sheet exists for a particular device, please check with one of the following:

- Microchip's Worldwide Web site; <http://www.microchip.com>
- Your local Microchip sales office (see last page)

When contacting a sales office, please specify which device, revision of silicon and data sheet (include literature number) you are using.

Customer Notification System

Register on our web site at www.microchip.com to receive the most current information on all of our products.

Referenced Sources

This device data sheet is based on the following individual chapters of the “*dsPIC33F/PIC24H Family Reference Manual*”. These documents should be considered as the general reference for the operation of a particular module or device feature.

Note 1: To access the documents listed below, browse to the documentation section of the [PIC24HJ64GP204](#) product page of the Microchip web site (www.microchip.com) or select a family reference manual section from the following list.

In addition to parameters, features, and other documentation, the resulting page provides links to the related family reference manual sections.

- **Section 1. “Introduction”** (DS70197)
- **Section 2. “CPU”** (DS70204)
- **Section 3. “Data Memory”** (DS70202)
- **Section 4. “Program Memory”** (DS70202)
- **Section 5. “Flash Programming”** (DS70191)
- **Section 8. “Reset”** (DS70192)
- **Section 9. “Watchdog Timer and Power-saving Modes”** (DS70196)
- **Section 11. “Timers”** (DS70205)
- **Section 12. “Input Capture”** (DS70198)
- **Section 13. “Output Compare”** (DS70209)
- **Section 16. “Analog-to-Digital Converter (ADC)”** (DS70183)
- **Section 17. “UART”** (DS70188)
- **Section 18. “Serial Peripheral Interface (SPI)”** (DS70206)
- **Section 19. “Inter-Integrated Circuit™ (I²C™)”** (DS70195)
- **Section 23. “CodeGuard™ Security”** (DS70199)
- **Section 24. “Programming and Diagnostics”** (DS70209)
- **Section 25. “Device Configuration”** (DS70194)
- **Section 30. “I/O Ports with Peripheral Pin Select (PPS)”** (DS70190)
- **Section 32. “Interrupts (Part III)”** (DS70214)
- **Section 33. “Audio Digital-to-Analog Converter (DAC)”** (DS70211)
- **Section 34. “Comparator”** (DS70212)
- **Section 35. “Parallel Master Port (PMP)”** (DS70299)
- **Section 36. “Programmable Cyclic Redundancy Check (CRC)”** (DS70298)
- **Section 37. “Real-Time Clock and Calendar (RTCC)”** (DS70301)
- **Section 38. “Direct Memory Access”** (DS70215)
- **Section 39. “Oscillator (Part III)”** (DS70216)

1.0 DEVICE OVERVIEW

Note 1: This data sheet summarizes the features of the PIC24HJ32GP302/304, PIC24HJ64GPX02/X04 and PIC24HJ128GPX02/X04 families of devices. It is not intended to be a comprehensive reference source. To complement the information in this data sheet, refer to the “*dsPIC33F/PIC24H Family Reference Manual*”. Please see the Microchip web site (www.microchip.com) for the latest dsPIC33F/PIC24H Family Reference Manual sections.

2: Some registers and associated bits described in this section may not be available on all devices. Refer to **Section 4.0 “Memory Organization”** in this data sheet for device-specific register and bit information.

This document contains device specific information for the PIC24HJ32GP302/304, PIC24HJ64GPX02/X04 and PIC24HJ128GPX02/X04 devices.

[Figure 1-1](#) shows a general block diagram of the core and peripheral modules in the PIC24HJ32GP302/304, PIC24HJ64GPX02/X04 and PIC24HJ128GPX02/X04 families of devices.

[Table 1-1](#) lists the functions of the various pins shown in the pinout diagrams.

PIC24HJ32GP302/304, PIC24HJ64GPX02/X04 AND PIC24HJ128GPX02/X04

FIGURE 1-1: PIC24HJ32GP302/304, PIC24HJ64GPX02/X04 AND PIC24HJ128GPX02/X04 BLOCK DIAGRAM



Note: Not all pins or features are implemented on all device pinout configurations. See **"Pin Diagrams"** for the specific pins and features present on each device.

TABLE 1-1: PINOUT I/O DESCRIPTIONS

Pin Name	Pin Type	Buffer Type	PPS	Description
AN0-AN12	I	Analog		Analog input channels.
CLKI	I	ST/CMOS	No	External clock source input. Always associated with OSC1 pin function. Oscillator crystal output. Connects to crystal or resonator in Crystal Oscillator mode. Optionally functions as CLKO in RC and EC modes.
CLKO	O	—	No	Always associated with OSC2 pin function.
OSC1	I	ST/CMOS	No	Oscillator crystal input. ST buffer when configured in RC mode; CMOS otherwise.
OSC2	I/O	—	No	Oscillator crystal output. Connects to crystal or resonator in Crystal Oscillator mode. Optionally functions as CLKO in RC and EC modes.
SOSCI	I	ST/CMOS	No	32.768 kHz low-power oscillator crystal input; CMOS otherwise.
SOSCO	O	—	No	32.768 kHz low-power oscillator crystal output.
CN0-CN30	I	ST	No	Change notification inputs. Can be software programmed for internal weak pull-ups on all inputs.
IC1-IC2	I	ST	Yes	Capture inputs 1/2
IC7-IC8	I	ST	Yes	Capture inputs 7/8.
OCFA	I	ST	Yes	Compare Fault A input (for Compare Channels 1, 2, 3 and 4).
OC1-OC4	O	—	Yes	Compare outputs 1 through 4.
INT0	I	ST	No	External interrupt 0.
INT1	I	ST	Yes	External interrupt 1.
INT2	I	ST	Yes	External interrupt 2.
RA0-RA4	I/O	ST	No	PORTA is a bidirectional I/O port.
RA7-RA10	I/O	ST	No	PORTA is a bidirectional I/O port.
RB0-RB15	I/O	ST	No	PORTB is a bidirectional I/O port.
RC0-RC9	I/O	ST	No	PORTC is a bidirectional I/O port.
T1CK	I	ST	No	Timer1 external clock input.
T2CK	I	ST	Yes	Timer2 external clock input.
T3CK	I	ST	Yes	Timer3 external clock input.
T4CK	I	ST	Yes	Timer4 external clock input.
T5CK	I	ST	Yes	Timer5 external clock input.
$\overline{U1CTS}$	I	ST	Yes	UART1 clear to send.
U1RTS	O	—	Yes	UART1 ready to send.
U1RX	I	ST	Yes	UART1 receive.
U1TX	O	—	Yes	UART1 transmit.
$\overline{U2CTS}$	I	ST	Yes	UART2 clear to send.
U2RTS	O	—	Yes	UART2 ready to send.
U2RX	I	ST	Yes	UART2 receive.
U2TX	O	—	Yes	UART2 transmit.
SCK1	I/O	ST	Yes	Synchronous serial clock input/output for SPI1.
SDI1	I	ST	Yes	SPI1 data in.
SDO1	O	—	Yes	SPI1 data out.
SS1	I/O	ST	Yes	SPI1 slave synchronization or frame pulse I/O.
SCK2	I/O	ST	Yes	Synchronous serial clock input/output for SPI2.
SDI2	I	ST	Yes	SPI2 data in.
SDO2	O	—	Yes	SPI2 data out.
SS2	I/O	ST	Yes	SPI2 slave synchronization or frame pulse I/O.

Legend: CMOS = CMOS compatible input or output Analog = Analog input P = Power
 ST = Schmitt Trigger input with CMOS levels O = Output I = Input
 PPS = Peripheral Pin Select TTL = TTL input buffer

PIC24HJ32GP302/304, PIC24HJ64GPX02/X04 AND PIC24HJ128GPX02/X04

TABLE 1-1: PINOUT I/O DESCRIPTIONS (CONTINUED)

Pin Name	Pin Type	Buffer Type	PPS	Description
SCL1	I/O	ST	No	Synchronous serial clock input/output for I2C1.
SDA1	I/O	ST	No	Synchronous serial data input/output for I2C1.
ASCL1	I/O	ST	No	Alternate synchronous serial clock input/output for I2C1.
ASDA1	I/O	ST	No	Alternate synchronous serial data input/output for I2C1.
TMS	I	ST	No	JTAG Test mode select pin.
TCK	I	ST	No	JTAG test clock input pin.
TDI	I	ST	No	JTAG test data input pin.
TDO	O	—	No	JTAG test data output pin.
C1RX	I	ST	Yes	ECAN1 bus receive pin.
C1TX	O	—	Yes	ECAN1 bus transmit pin.
RTCC	O	—	No	Real-Time Clock Alarm Output.
CVREF	O	ANA	No	Comparator Voltage Reference Output.
C1IN-	I	ANA	No	Comparator 1 Negative Input.
C1IN+	I	ANA	No	Comparator 1 Positive Input.
C1OUT	O	—	Yes	Comparator 1 Output.
C2IN-	I	ANA	No	Comparator 2 Negative Input.
C2IN+	I	ANA	No	Comparator 2 Positive Input.
C2OUT	O	—	Yes	Comparator 2 Output.
PMA0	I/O	TTL/ST	No	Parallel Master Port Address Bit 0 Input (Buffered Slave modes) and Output (Master modes).
PMA1	I/O	TTL/ST	No	Parallel Master Port Address Bit 1 Input (Buffered Slave modes) and Output (Master modes).
PMA2 -PMPA10	O	—	No	Parallel Master Port Address (Demultiplexed Master Modes).
PMBE	O	—	No	Parallel Master Port Byte Enable Strobe.
PMCS1	O	—	No	Parallel Master Port Chip Select 1 Strobe.
PMD0-PMPD7	I/O	TTL/ST	No	Parallel Master Port Data (Demultiplexed Master mode) or Address/Data (Multiplexed Master modes).
PMRD	O	—	No	Parallel Master Port Read Strobe.
PMWR	O	—	No	Parallel Master Port Write Strobe.
PGED1	I/O	ST	No	Data I/O pin for programming/debugging communication channel 1.
PGEC1	I	ST	No	Clock input pin for programming/debugging communication channel 1.
PGED2	I/O	ST	No	Data I/O pin for programming/debugging communication channel 2.
PGEC2	I	ST	No	Clock input pin for programming/debugging communication channel 2.
PGED3	I/O	ST	No	Data I/O pin for programming/debugging communication channel 3.
PGEC3	I	ST	No	Clock input pin for programming/debugging communication channel 3.
MCLR	I/P	ST	No	Master Clear (Reset) input. This pin is an active-low Reset to the device.
AVDD	P	P	No	Positive supply for analog modules. This pin must be connected at all times.
AVSS	P	P	No	Ground reference for analog modules.
VDD	P	—	No	Positive supply for peripheral logic and I/O pins.
VCAP	P	—	No	CPU logic filter capacitor connection.
VSS	P	—	No	Ground reference for logic and I/O pins.
VREF+	I	Analog	No	Analog voltage reference (high) input.
VREF-	I	Analog	No	Analog voltage reference (low) input.

Legend: CMOS = CMOS compatible input or output Analog = Analog input P = Power
 ST = Schmitt Trigger input with CMOS levels O = Output I = Input
 PPS = Peripheral Pin Select TTL = TTL input buffer

2.0 GUIDELINES FOR GETTING STARTED WITH 16-BIT MICROCONTROLLERS

- Note 1:** This data sheet summarizes the features of the PIC24HJ32GP302/304, PIC24HJ64GPX02/X04 and PIC24HJ128GPX02/X04 family of devices. It is not intended to be a comprehensive reference source. To complement the information in this data sheet, refer to the “*dsPIC33F/PIC24H Family Reference Manual*”. Please see the Microchip web site (www.microchip.com) for the latest dsPIC33F/PIC24H Family Reference Manual sections.
- 2:** Some registers and associated bits described in this section may not be available on all devices. Refer to **Section 4.0 “Memory Organization”** in this data sheet for device-specific register and bit information.

2.1 Basic Connection Requirements

Getting started with the PIC24HJ32GP302/304, PIC24HJ64GPX02/X04 and PIC24HJ128GPX02/X04 family of 16-bit Microcontrollers (MCUs) requires attention to a minimal set of device pin connections before proceeding with development. The following is a list of pin names, which must always be connected:

- All VDD and VSS pins (see **Section 2.2 “Decoupling Capacitors”**)
- All AVDD and AVSS pins (regardless if ADC module is not used) (see **Section 2.2 “Decoupling Capacitors”**)
- VCAP (see **Section 2.3 “CPU Logic Filter Capacitor Connection (VCAP)”**)
- $\overline{\text{MCLR}}$ pin (see **Section 2.4 “Master Clear (MCLR) Pin”**)
- PGECx/PGEDx pins used for In-Circuit Serial Programming™ (ICSP™) and debugging purposes (see **Section 2.5 “ICSP Pins”**)
- OSC1 and OSC2 pins when external oscillator source is used (see **Section 2.6 “External Oscillator Pins”**)

Additionally, the following pins may be required:

- VREF+/VREF- pins used when external voltage reference for ADC module is implemented

Note: The AVDD and AVSS pins must be connected independent of the ADC voltage reference source.

2.2 Decoupling Capacitors

The use of decoupling capacitors on every pair of power supply pins, such as VDD, VSS, AVDD and AVSS is required.

Consider the following criteria when using decoupling capacitors:

- **Value and type of capacitor:** Recommendation of 0.1 μF (100 nF), 10-20V. This capacitor should be a low-ESR and have resonance frequency in the range of 20 MHz and higher. It is recommended that ceramic capacitors be used.
- **Placement on the printed circuit board:** The decoupling capacitors should be placed as close to the pins as possible. It is recommended to place the capacitors on the same side of the board as the device. If space is constricted, the capacitor can be placed on another layer on the PCB using a via; however, ensure that the trace length from the pin to the capacitor is within one-quarter inch (6 mm) in length.
- **Handling high frequency noise:** If the board is experiencing high frequency noise, upward of tens of MHz, add a second ceramic-type capacitor in parallel to the above described decoupling capacitor. The value of the second capacitor can be in the range of 0.01 μF to 0.001 μF . Place this second capacitor next to the primary decoupling capacitor. In high-speed circuit designs, consider implementing a decade pair of capacitances as close to the power and ground pins as possible. For example, 0.1 μF in parallel with 0.001 μF .
- **Maximizing performance:** On the board layout from the power supply circuit, run the power and return traces to the decoupling capacitors first, and then to the device pins. This ensures that the decoupling capacitors are first in the power chain. Equally important is to keep the trace length between the capacitor and the power pins to a minimum thereby reducing PCB track inductance.

FIGURE 2-1: RECOMMENDED MINIMUM CONNECTION



2.2.1 TANK CAPACITORS

On boards with power traces running longer than six inches in length, it is suggested to use a tank capacitor for integrated circuits including MCUs to supply a local power source. The value of the tank capacitor should be determined based on the trace resistance that connects the power supply source to the device, and the maximum current drawn by the device in the application. In other words, select the tank capacitor so that it meets the acceptable voltage sag at the device. Typical values range from 4.7 µF to 47 µF.

2.3 CPU Logic Filter Capacitor Connection (VCAP)

A low-ESR (< 5 Ohms) capacitor is required on the VCAP pin, which is used to stabilize the voltage regulator output voltage. The VCAP pin must not be connected to VDD, and must have a capacitor between 4.7 µF and 10 µF, preferably surface mount connected within one-eighths inch of the VCAP pin connected to ground. The type can be ceramic or tantalum. Refer to [Section 28.0 “Electrical Characteristics”](#) for additional information.

The placement of this capacitor should be close to the VCAP. It is recommended that the trace length not exceed one-quarter inch (6 mm). Refer to [Section 25.2 “On-Chip Voltage Regulator”](#) for details.

2.4 Master Clear (MCLR) Pin

The MCLR pin provides for two specific device functions:

- Device Reset
- Device programming and debugging

During device programming and debugging, the resistance and capacitance that can be added to the pin must be considered. Device programmers and debuggers drive the MCLR pin. Consequently, specific voltage levels (VIH and VIL) and fast signal transitions must not be adversely affected. Therefore, specific values of R and C will need to be adjusted based on the application and PCB requirements.

For example, as shown in [Figure 2-2](#), it is recommended that the capacitor C, be isolated from the MCLR pin during programming and debugging operations.

Place the components shown in [Figure 2-2](#) within one-quarter inch (6 mm) from the MCLR pin.

FIGURE 2-2: EXAMPLE OF MCLR PIN CONNECTIONS



2.5 ICSP Pins

The PGECx and PGEDx pins are used for In-Circuit Serial Programming™ (ICSP™) and debugging purposes. It is recommended to keep the trace length between the ICSP connector and the ICSP pins on the device as short as possible. If the ICSP connector is expected to experience an ESD event, a series resistor is recommended, with the value in the range of a few tens of Ohms, not to exceed 100 Ohms.

Pull-up resistors, series diodes, and capacitors on the PGECx and PGEDx pins are not recommended as they will interfere with the programmer/debugger communications to the device. If such discrete components are an application requirement, they should be removed from the circuit during programming and debugging. Alternatively, refer to the AC/DC characteristics and timing requirements information in the respective device Flash programming specification for information on capacitive loading limits and pin input voltage high (V_{IH}) and input low (V_{IL}) requirements.

Ensure that the “Communication Channel Select” (i.e., PGECx/PGEDx pins) programmed into the device matches the physical connections for the ICSP to MPLAB® ICD 3 or MPLAB REAL ICE™.

For more information on ICD 3 and REAL ICE connection requirements, refer to the following documents that are available on the Microchip web site.

- “Using MPLAB® ICD 3” (poster) DS51765
- “MPLAB® ICD 3 Design Advisory” DS51764
- “MPLAB® REAL ICE™ In-Circuit Emulator User’s Guide” DS51616
- “Using MPLAB® REAL ICE™” (poster) DS51749

2.6 External Oscillator Pins

Many MCUs have options for at least two oscillators: a high-frequency primary oscillator and a low-frequency secondary oscillator (refer to [Section 9.0 “Oscillator Configuration”](#) for details).

The oscillator circuit should be placed on the same side of the board as the device. Also, place the oscillator circuit close to the respective oscillator pins, not exceeding one-half inch (12 mm) distance between them. The load capacitors should be placed next to the oscillator itself, on the same side of the board. Use a grounded copper pour around the oscillator circuit to isolate them from surrounding circuits. The grounded copper pour should be routed directly to the MCU ground. Do not run any signal traces or power traces inside the ground pour. Also, if using a two-sided board, avoid any traces on the other side of the board where the crystal is placed. A suggested layout is shown in [Figure 2-3](#). Recommendations for crystals and ceramic resonators are provided in [Table 2-1](#) and [Table 2-2](#), respectively.

FIGURE 2-3: SUGGESTED PLACEMENT OF THE OSCILLATOR CIRCUIT



TABLE 2-1: CRYSTAL RECOMMENDATIONS

Part Number	Vendor	Freq.	Load Cap.	Package Case	Frequency Tolerance	Mounting Type	Operating Temperature
ECS-40-20-4DN	ECS Inc.	4 MHz	20 pF	HC49/US	±30 ppm	TH	-40°C to +85°C
ECS-80-18-4DN	ECS Inc.	8 MHz	18 pF	HC49/US	±30 ppm	TH	-40°C to +85°C
ECS-100-18-4-DN	ECS Inc.	10 MHz	18 pF	HC49/US	±30 ppm	TH	-40°C to +85°C
ECS-200-20-4DN	ECS Inc.	20 MHz	20 pF	HC49/US	±30 ppm	TH	-40°C to +85°C
ECS-40-20-5G3XDS-TR	ECS Inc.	4 MHz	20 pF	HC49/US	±30 ppm	SM	-40°C to +125°C
ECS-80-20-5G3XDS-TR	ECS Inc.	8 MHz	20 pF	HC49/US	±30 ppm	SM	-40°C to +125°C
ECS-100-20-5G3XDS-TR	ECS Inc.	10 MHz	20 pF	HC49/US	±30 ppm	SM	-40°C to +125°C
ECS-200-20-5G3XDS-TR	ECS Inc.	20 MHz	20 pF	HC49/US	±30 ppm	SM	-40°C to 125°C
NX3225SA 20MHZ AT-W	NDK	20 MHz	8 pF	3.2 mm x 2.5 mm	±50 ppm	SM	-40°C to 125°C

Legend: TH = Through Hole SM = Surface Mount

TABLE 2-2: RESONATOR RECOMMENDATIONS

Part Number	Vendor	Freq.	Load Cap.	Package Case	Frequency Tolerance	Mounting Type	Operating Temperature
FCR4.0M5T	TDK Corp.	4 MHz	N/A	Radial	±0.5%	TH	-40°C to +85°C
FCR8.0M5	TDK Corp.	8 MHz	N/A	Radial	±0.5%	TH	-40°C to +85°C
HWZT-10.00MD	TDK Corp.	10 MHz	N/A	Radial	±0.5%	TH	-40°C to +85°C
HWZT-20.00MD	TDK Corp.	20 MHz	N/A	Radial	±0.5%	TH	-40°C to +85°C

Legend: TH = Through Hole

2.7 Oscillator Value Conditions on Device Start-up

If the PLL of the target device is enabled and configured for the device start-up oscillator, the maximum oscillator source frequency must be limited to ≤8 MHz for start-up with the PLL enabled to comply with device PLL start-up conditions. This means that if the external oscillator frequency is outside this range, the application must start-up in the FRC mode first. The default PLL settings after a POR with an oscillator frequency outside this range will violate the device operating speed.

Once the device powers up, the application firmware can initialize the PLL SFRs, CLKDIV and PLLDBF to a suitable value, and then perform a clock switch to the Oscillator + PLL clock source. Note that clock switching must be enabled in the device Configuration word.

2.8 Configuration of Analog and Digital Pins During ICSP Operations

If MPLAB ICD 3 or REAL ICE is selected as a debugger, it automatically initializes all of the A/D input pins (ANx) as “digital” pins, by setting all bits in the AD1PCFGL register.

The bits in this register that correspond to the A/D pins that are initialized by MPLAB ICD 3 or REAL ICE, must not be cleared by the user application firmware; otherwise, communication errors will result between the debugger and the device.

If your application needs to use certain A/D pins as analog input pins during the debug session, the user application must clear the corresponding bits in the AD1PCFGL register during initialization of the ADC module.

When MPLAB ICD 3 or REAL ICE is used as a programmer, the user application firmware must correctly configure the AD1PCFGL register. Automatic initialization of this register is only done during debugger operation. Failure to correctly configure the register(s) will result in all A/D pins being recognized as analog input pins, resulting in the port value being read as a logic ‘0’, which may affect user application functionality.

2.9 Unused I/Os

Unused I/O pins should be configured as outputs and driven to a logic-low state.

Alternatively, connect a 1k to 10k resistor between Vss and the unused pins.

3.0 CPU

Note 1: This data sheet summarizes the features of the PIC24HJ32GP302/304, PIC24HJ64GPX02/X04 and PIC24HJ128GPX02/X04 families of devices. It is not intended to be a comprehensive reference source. To complement the information in this data sheet, refer to **Section 2. “CPU”** (DS70204) of the “*dsPIC33F/PIC24H Family Reference Manual*”, which is available from the Microchip web site (www.microchip.com).

2: Some registers and associated bits described in this section may not be available on all devices. Refer to **Section 4.0 “Memory Organization”** in this data sheet for device-specific register and bit information.

3.1 Overview

The PIC24HJ32GP302/304, PIC24HJ64GPX02/X04 and PIC24HJ128GPX02/X04 CPU module has a 16-bit (data) modified Harvard architecture with an enhanced instruction set and addressing modes. The CPU has a 24-bit instruction word with a variable length opcode field. The Program Counter (PC) is 23 bits wide and addresses up to 4M x 24 bits of user program memory space. The actual amount of program memory implemented varies by device. A single-cycle instruction prefetch mechanism is used to help maintain throughput and provides predictable execution. All instructions execute in a single cycle, with the exception of instructions that change the program flow, the double word move (*MOV.D*) instruction and the table instructions. Overhead-free, single-cycle program loop constructs are supported using the *REPEAT* instruction, which is interruptible at any point.

The PIC24HJ32GP302/304, PIC24HJ64GPX02/X04 and PIC24HJ128GPX02/X04 devices have sixteen, 16-bit working registers in the programmer’s model. Each of the working registers can serve as a data, address or address offset register. The 16th working register (W15) operates as a software Stack Pointer (SP) for interrupts and calls.

The PIC24HJ32GP302/304, PIC24HJ64GPX02/X04 and PIC24HJ128GPX02/X04 instruction set includes many addressing modes and is designed for optimum C compiler efficiency. For most instructions, the PIC24HJ32GP302/304, PIC24HJ64GPX02/X04 and PIC24HJ128GPX02/X04 is capable of executing a data (or program data) memory read, a working register (data) read, a data memory write and a program (instruction) memory read per instruction cycle. As a result, three parameter instructions can be supported, allowing $A + B = C$ operations to be executed in a single cycle.

A block diagram of the CPU is shown in [Figure 3-1](#), and the programmer’s model for the PIC24HJ32GP302/304, PIC24HJ64GPX02/X04 and PIC24HJ128GPX02/X04 is shown in [Figure 3-2](#).

3.2 Data Addressing Overview

The data space can be linearly addressed as 32K words or 64 Kbytes using an Address Generation Unit (AGU). The upper 32 Kbytes of the data space memory map can optionally be mapped into program space at any 16K program word boundary defined by the 8-bit Program Space Visibility Page (PSVPAG) register. The program to data space mapping feature lets any instruction access program space as if it were data space.

The data space also includes 2 Kbytes of DMA RAM, which is primarily used for DMA data transfers, but may be used as general purpose RAM.

3.3 Special MCU Features

The PIC24HJ32GP302/304, PIC24HJ64GPX02/X04 and PIC24HJ128GPX02/X04 features a 17-bit by 17-bit, single-cycle multiplier. The multiplier can perform signed, unsigned and mixed-sign multiplication. Using a 17-bit by 17-bit multiplier for 16-bit by 16-bit multiplication makes mixed-sign multiplication possible.

The PIC24HJ32GP302/304, PIC24HJ64GPX02/X04 and PIC24HJ128GPX02/X04 devices support 16/16 and 32/16 integer divide operations. All divide instructions are iterative operations. They must be executed within a REPEAT loop, resulting in a total execution time of 19 instruction cycles. The divide operation can be interrupted during any of those 19 cycles without loss of data.

A multi-bit data shifter is used to perform up to a 16-bit, left or right shift in a single cycle.

FIGURE 3-1: PIC24HJ32GP302/304, PIC24HJ64GPX02/X04 AND PIC24HJ128GPX02/X04 CPU CORE BLOCK DIAGRAM



FIGURE 3-2: PIC24HJ32GP302/304, PIC24HJ64GPX02/X04 AND PIC24HJ128GPX02/X04 PROGRAMMER'S MODEL



3.4 CPU Resources

Many useful resources related to the CPU are provided on the main product page of the Microchip web site for the devices listed in this data sheet. This product page, which can be accessed using this [link](#), contains the latest updates and additional information.

<p>Note: In the event you are not able to access the product page using the link above, enter this URL in your browser: http://www.microchip.com/wwwproducts/Devices.aspx?dDocName=en534555</p>
--

3.4.1 KEY RESOURCES

- **Section 2. “CPU”** (DS70204)
- Code Samples
- Application Notes
- Software Libraries
- Webinars
- All related dsPIC33F/PIC24H Family Reference Manuals Sections
- Development Tools

3.5 CPU Control Registers

REGISTER 3-1: SR: CPU STATUS REGISTER

U-0	U-0	U-0	U-0	U-0	U-0	U-0	R/W-0
—	—	—	—	—	—	—	DC
bit 15							bit 8
R/W-0 ⁽¹⁾	R/W-0 ⁽²⁾	R/W-0 ⁽²⁾	R-0	R/W-0	R/W-0	R/W-0	R/W-0
IPL<2:0> ⁽²⁾			RA	N	OV	Z	C
bit 7							bit 0

Legend:		
C = Clear only bit	R = Readable bit	U = Unimplemented bit, read as '0'
S = Set only bit	W = Writable bit	-n = Value at POR
'1' = Bit is set	'0' = Bit is cleared	x = Bit is unknown

- bit 15-9 **Unimplemented:** Read as '0'
- bit 8 **DC:** MCU ALU Half Carry/Borrow bit
 - 1 = A carry-out from the 4th low-order bit (for byte-sized data) or 8th low-order bit (for word-sized data) of the result occurred
 - 0 = No carry-out from the 4th low-order bit (for byte-sized data) or 8th low-order bit (for word-sized data) of the result occurred
- bit 7-5 **IPL<2:0>:** CPU Interrupt Priority Level Status bits⁽²⁾
 - 111 = CPU Interrupt Priority Level is 7 (15), user interrupts disabled
 - 110 = CPU Interrupt Priority Level is 6 (14)
 - 101 = CPU Interrupt Priority Level is 5 (13)
 - 100 = CPU Interrupt Priority Level is 4 (12)
 - 011 = CPU Interrupt Priority Level is 3 (11)
 - 010 = CPU Interrupt Priority Level is 2 (10)
 - 001 = CPU Interrupt Priority Level is 1 (9)
 - 000 = CPU Interrupt Priority Level is 0 (8)
- bit 4 **RA:** REPEAT Loop Active bit
 - 1 = REPEAT loop in progress
 - 0 = REPEAT loop not in progress
- bit 3 **N:** MCU ALU Negative bit
 - 1 = Result was negative
 - 0 = Result was non-negative (zero or positive)
- bit 2 **OV:** MCU ALU Overflow bit
 - This bit is used for signed arithmetic (two's complement). It indicates an overflow of a magnitude that causes the sign bit to change state.
 - 1 = Overflow occurred for signed arithmetic (in this arithmetic operation)
 - 0 = No overflow occurred
- bit 1 **Z:** MCU ALU Zero bit
 - 1 = An operation that affects the Z bit has set it at some time in the past
 - 0 = The most recent operation that affects the Z bit has cleared it (i.e., a non-zero result)
- bit 0 **C:** MCU ALU Carry/Borrow bit
 - 1 = A carry-out from the Most Significant bit of the result occurred
 - 0 = No carry-out from the Most Significant bit of the result occurred

Note 1: The IPL<2:0> bits are concatenated with the IPL<3> bit (CORCON<3>) to form the CPU Interrupt Priority Level. The value in parentheses indicates the IPL if IPL<3> = 1. User interrupts are disabled when IPL<3> = 1.

2: The IPL<2:0> Status bits are read only when the NSTDIS bit (INTCON1<15>) = 1.

PIC24HJ32GP302/304, PIC24HJ64GPX02/X04 AND PIC24HJ128GPX02/X04

REGISTER 3-2: CORCON: CORE CONTROL REGISTER

U-0	U-0	U-0	U-0	U-0	U-0	U-0	U-0
—	—	—	—	—	—	—	—
bit 15							bit 8

U-0	U-0	U-0	U-0	R/C-0	R/W-0	U-0	U-0
—	—	—	—	IPL3 ⁽¹⁾	PSV	—	—
bit 7							bit 0

Legend:	C = Clear only bit		
R = Readable bit	W = Writable bit	-n = Value at POR	'1' = Bit is set
0' = Bit is cleared	'x' = Bit is unknown	U = Unimplemented bit, read as '0'	

- bit 15-4 **Unimplemented:** Read as '0'
- bit 3 **IPL3:** CPU Interrupt Priority Level Status bit 3⁽¹⁾
 1 = CPU interrupt priority level is greater than 7
 0 = CPU interrupt priority level is 7 or less
- bit 2 **PSV:** Program Space Visibility in Data Space Enable bit
 1 = Program space visible in data space
 0 = Program space not visible in data space
- bit 1-0 **Unimplemented:** Read as '0'

Note 1: The IPL3 bit is concatenated with the IPL<2:0> bits (SR<7:5>) to form the CPU interrupt priority level.

3.6 Arithmetic Logic Unit (ALU)

The PIC24HJ32GP302/304, PIC24HJ64GPX02/X04 and PIC24HJ128GPX02/X04 ALU is 16 bits wide and is capable of addition, subtraction, bit shifts and logic operations. Unless otherwise mentioned, arithmetic operations are two's complement in nature. Depending on the operation, the ALU can affect the values of the Carry (C), Zero (Z), Negative (N), Overflow (OV) and Digit Carry (DC) Status bits in the SR register. The C and DC Status bits operate as Borrow and Digit Borrow bits, respectively, for subtraction operations.

The ALU can perform 8-bit or 16-bit operations, depending on the mode of the instruction that is used. Data for the ALU operation can come from the W register array or data memory, depending on the addressing mode of the instruction. Likewise, output data from the ALU can be written to the W register array or a data memory location.

For information on the SR bits affected by each instruction, refer to the "16-bit MCU and DSC Programmer's Reference Manual" (DS70157).

The PIC24HJ32GP302/304, PIC24HJ64GPX02/X04 and PIC24HJ128GPX02/X04 CPU incorporates hardware support for both multiplication and division. This includes a dedicated hardware multiplier and support hardware for 16-bit-divisor division.

3.6.1 MULTIPLIER

Using the high-speed 17-bit x 17-bit multiplier, the ALU supports unsigned, signed or mixed-sign operation in several MCU multiplication modes:

- 16-bit x 16-bit signed
- 16-bit x 16-bit unsigned
- 16-bit signed x 5-bit (literal) unsigned
- 16-bit unsigned x 16-bit unsigned
- 16-bit unsigned x 5-bit (literal) unsigned
- 16-bit unsigned x 16-bit signed
- 8-bit unsigned x 8-bit unsigned

3.6.2 DIVIDER

The divide block supports 32-bit/16-bit and 16-bit/16-bit signed and unsigned integer divide operations with the following data sizes:

- 32-bit signed/16-bit signed divide
- 32-bit unsigned/16-bit unsigned divide
- 16-bit signed/16-bit signed divide
- 16-bit unsigned/16-bit unsigned divide

The quotient for all divide instructions ends up in W0 and the remainder in W1. 16-bit signed and unsigned DIV instructions can specify any W register for both the 16-bit divisor (Wn) and any W register (aligned) pair (W(m + 1):Wm) for the 32-bit dividend. The divide algorithm takes one cycle per bit of divisor, so both 32-bit/16-bit and 16-bit/16-bit instructions take the same number of cycles to execute.

3.6.3 MULTI-BIT DATA SHIFTER

The multi-bit data shifter is capable of performing up to 16-bit arithmetic or logic right shifts, or up to 16-bit left shifts in a single cycle. The source can be either a working register or a memory location.

The shifter requires a signed binary value to determine both the magnitude (number of bits) and direction of the shift operation. A positive value shifts the operand right. A negative value shifts the operand left. A value of '0' does not modify the operand.

NOTES:

4.0 MEMORY ORGANIZATION

Note: This data sheet summarizes the features of the PIC24HJ32GP302/304, PIC24HJ64GPX02/X04 and PIC24HJ128GPX02/X04 families of devices. It is not intended to be a comprehensive reference source. To complement the information in this data sheet, refer to **Section 4. "Program Memory"** (DS70203) of the "dsPIC33F/PIC24H Family Reference Manual", which is available from the Microchip web site (www.microchip.com).

The PIC24HJ32GP302/304, PIC24HJ64GPX02/X04 and PIC24HJ128GPX02/X04 architecture features separate program and data memory spaces and buses. This architecture also allows the direct access of program memory from the data space during code execution.

4.1 Program Address Space

The program address memory space of the PIC24HJ32GP302/304, PIC24HJ64GPX02/X04 and PIC24HJ128GPX02/X04 devices is 4M instructions. The space is addressable by a 24-bit value derived either from the 23-bit Program Counter (PC) during program execution, or from table operation or data space remapping as described in **Section 4.6 "Interfacing Program and Data Memory Spaces"**.

User application access to the program memory space is restricted to the lower half of the address range (0x000000 to 0x7FFFFFFF). The exception is the use of TBLRD/TBLWT operations, which use TBLPAG<7> to permit access to the Configuration bits and Device ID sections of the configuration memory space.

The memory map for the PIC24HJ32GP302/304, PIC24HJ64GPX02/X04 and PIC24HJ128GPX02/X04 devices is shown in **Figure 4-1**.

FIGURE 4-1: PROGRAM MEMORY MAP FOR PIC24HJ32GP302/304, PIC24HJ64GPX02/X04 AND PIC24HJ128GPX02/X04 DEVICES



PIC24HJ32GP302/304, PIC24HJ64GPX02/X04 AND PIC24HJ128GPX02/X04

4.1.1 PROGRAM MEMORY ORGANIZATION

The program memory space is organized in word-addressable blocks. Although it is treated as 24 bits wide, it is more appropriate to think of each address of the program memory as a lower and upper word, with the upper byte of the upper word being unimplemented. The lower word always has an even address, while the upper word has an odd address, as shown in [Figure 4-2](#).

Program memory addresses are always word-aligned on the lower word, and addresses are incremented or decremented by two during code execution. This arrangement provides compatibility with data memory space addressing and makes data in the program memory space accessible.

4.1.2 INTERRUPT AND TRAP VECTORS

All PIC24HJ32GP302/304, PIC24HJ64GPX02/X04 and PIC24HJ128GPX02/X04 devices reserve the addresses between 0x00000 and 0x000200 for hard-coded program execution vectors. A hardware Reset vector is provided to redirect code execution from the default value of the PC on device Reset to the actual start of code. A `GOTO` instruction is programmed by the user application at 0x000000, with the actual address for the start of code at 0x000002.

PIC24HJ32GP302/304, PIC24HJ64GPX02/X04 and PIC24HJ128GPX02/X04 devices also have two interrupt vector tables, located from 0x000004 to 0x0000FF and 0x000100 to 0x0001FF. These vector tables allow each of the device interrupt sources to be handled by separate Interrupt Service Routines (ISRs). A more detailed discussion of the interrupt vector tables is provided in [Section 7.1 “Interrupt Vector Table”](#).

FIGURE 4-2: PROGRAM MEMORY ORGANIZATION



4.2 Data Address Space

The PIC24HJ32GP302/304, PIC24HJ64GPX02/X04 and PIC24HJ128GPX02/X04 CPU has a separate 16-bit wide data memory space. The data space is accessed using separate Address Generation Units (AGUs) for read and write operations. The data memory maps are shown in [Figure 4-3](#) and [Figure 4-4](#).

All Effective Addresses (EAs) in the data memory space are 16 bits wide and point to bytes within the data space. This arrangement gives a data space address range of 64 Kbytes or 32K words. The lower half of the data memory space (that is, when $EA_{<15>} = 0$) is used for implemented memory addresses, while the upper half ($EA_{<15>} = 1$) is reserved for the Program Space Visibility area (see [Section 4.6.3 “Reading Data from Program Memory Using Program Space Visibility”](#)).

PIC24HJ32GP302/304, PIC24HJ64GPX02/X04 and PIC24HJ128GPX02/X04 devices implement up to 8 Kbytes of data memory. Should an EA point to a location outside of this area, an all-zero word or byte is returned.

4.2.1 DATA SPACE WIDTH

The data memory space is organized in byte addressable, 16-bit wide blocks. Data is aligned in data memory and registers as 16-bit words, but all data space EAs resolve to bytes. The Least Significant Bytes (LSBs) of each word have even addresses, while the Most Significant Bytes (MSBs) have odd addresses.

4.2.2 DATA MEMORY ORGANIZATION AND ALIGNMENT

To maintain backward compatibility with PIC® MCU devices and improve data space memory usage efficiency, the PIC24HJ32GP302/304, PIC24HJ64GPX02/X04 and PIC24HJ128GPX02/X04 instruction set supports both word and byte operations. As a consequence of byte accessibility, all effective address calculations are internally scaled to step through word-aligned memory. For example, the core recognizes that Post-Modified Register Indirect Addressing mode [Ws++] results in a value of $Ws + 1$ for byte operations and $Ws + 2$ for word operations.

A data byte read, reads the complete word that contains the byte, using the LSB of any EA to determine which byte to select. The selected byte is placed onto the LSB of the data path. That is, data memory and registers are organized as two parallel byte-wide entities with shared (word) address decode but separate write lines. Data byte writes only write to the corresponding side of the array or register that matches the byte address.

All word accesses must be aligned to an even address. Misaligned word data fetches are not supported, so care must be taken when mixing byte and word operations, or translating from 8-bit MCU code. If a misaligned read or write is attempted, an address error trap is generated. If the error occurred on a read, the instruction underway is completed. If the error occurred on a write, the instruction is executed but the write does not occur. In either case, a trap is then executed, allowing the system and/or user application to examine the machine state prior to execution of the address Fault.

All byte loads into any W register are loaded into the Least Significant Byte. The Most Significant Byte is not modified.

A sign-extend instruction (SE) is provided to allow user applications to translate 8-bit signed data to 16-bit signed values. Alternatively, for 16-bit unsigned data, user applications can clear the MSB of any W register by executing a zero-extend (ZE) instruction on the appropriate address.

4.2.3 SFR SPACE

The first 2 Kbytes of the Near Data Space, from 0x0000 to 0x07FF, is primarily occupied by Special Function Registers (SFRs). These are used by the PIC24HJ32GP302/304, PIC24HJ64GPX02/X04 and PIC24HJ128GPX02/X04 core and peripheral modules for controlling the operation of the device.

SFRs are distributed among the modules that they control, and are generally grouped together by module. Much of the SFR space contains unused addresses; these are read as '0'.

Note: The actual set of peripheral features and interrupts varies by the device. Refer to the corresponding device tables and pinout diagrams for device-specific information.

4.2.4 NEAR DATA SPACE

The 8 Kbyte area between 0x0000 and 0x1FFF is referred to as the near data space. Locations in this space are directly addressable via a 13-bit absolute address field within all memory direct instructions. Additionally, the whole data space is addressable using MOV instructions, which support Memory Direct Addressing mode with a 16-bit address field, or by using Indirect Addressing mode using a working register as an address pointer.

PIC24HJ32GP302/304, PIC24HJ64GPX02/X04 AND PIC24HJ128GPX02/X04

4.2.5 DMA RAM

The PIC24HJ32GP302/304 devices contain 1 Kbytes of dual ported DMA RAM located at the end of X data space. The PIC24HJ64GPX02/X04 and PIC24HJ128GPX02/X04 devices contain 2 Kbytes of dual ported DMA RAM located at the end of X data space, and is a part of X data space. Memory locations in the DMA RAM space are accessible simultaneously by the CPU and the DMA controller module. DMA RAM is utilized by the DMA controller to store data to be transferred to various peripherals using DMA, as well as data transferred from various peripherals using DMA. The DMA RAM can be accessed by the DMA controller without having to steal cycles from the CPU.

When the CPU and the DMA controller attempt to concurrently write to the same DMA RAM location, the hardware ensures that the CPU is given precedence in accessing the DMA RAM location. Therefore, the DMA RAM provides a reliable means of transferring DMA data without ever having to stall the CPU.

Note: DMA RAM can be used for general purpose data storage if the DMA function is not required in an application.

FIGURE 4-3: DATA MEMORY MAP FOR PIC24HJ32GP302/304 DEVICES WITH 4 KB RAM



FIGURE 4-4: DATA MEMORY MAP FOR PIC24HJ128GP202/204, PIC24HJ64GP202/204, PIC24HJ128GP502/504 AND PIC24HJ64GP502/504 DEVICES WITH 8 KB RAM



4.3 Memory Organization Resources

Many useful resources related to Memory Organization are provided on the main product page of the Microchip web site for the devices listed in this data sheet. This product page, which can be accessed using this [link](#), contains the latest updates and additional information.

Note: In the event you are not able to access the product page using the link above, enter this URL in your browser:
<http://www.microchip.com/wwwproducts/Devices.aspx?dDoc-Name=en534555>

4.3.1 KEY RESOURCES

- **Section 4. “Program Memory”** (DS70203)
- Code Samples
- Application Notes
- Software Libraries
- Webinars
- All related dsPIC33F/PIC24H Family Reference Manuals Sections
- Development Tools

4.4 Special Function Register Maps

TABLE 4-1: CPU CORE REGISTERS MAP

SFR Name	SFR Addr	Bit 15	Bit 14	Bit 13	Bit 12	Bit 11	Bit 10	Bit 9	Bit 8	Bit 7	Bit 6	Bit 5	Bit 4	Bit 3	Bit 2	Bit 1	Bit 0	All Resets
WREG0	0000	Working Register 0																0000
WREG1	0002	Working Register 1																0000
WREG2	0004	Working Register 2																0000
WREG3	0006	Working Register 3																0000
WREG4	0008	Working Register 4																0000
WREG5	000A	Working Register 5																0000
WREG6	000C	Working Register 6																0000
WREG7	000E	Working Register 7																0000
WREG8	0010	Working Register 8																0000
WREG9	0012	Working Register 9																0000
WREG10	0014	Working Register 10																0000
WREG11	0016	Working Register 11																0000
WREG12	0018	Working Register 12																0000
WREG13	001A	Working Register 13																0000
WREG14	001C	Working Register 14																0000
WREG15	001E	Working Register 15																0800
SPLIM	0020	Stack Pointer Limit Register																xxxx
PCL	002E	Program Counter Low Word Register																0000
PCH	0030	—	—	—	—	—	—	—	—	Program Counter High Byte Register								0000
TBLPAG	0032	—	—	—	—	—	—	—	—	Table Page Address Pointer Register								0000
PSVPAG	0034	—	—	—	—	—	—	—	—	Program Memory Visibility Page Address Pointer Register								0000
RCOUNT	0036	Repeat Loop Counter Register																xxxx
SR	0042	—	—	—	—	—	—	—	DC	IPL2	IPL1	IPL0	RA	N	OV	Z	C	0000
CORCON	0044	—	—	—	—	—	—	—	—	—	—	—	—	IPL3	PSV	—	—	0000
DISICNT	0052	—	—	Disable Interrupts Counter Register													xxxx	

Legend: x = unknown value on Reset, — = unimplemented, read as '0'. Reset values are shown in hexadecimal.

TABLE 4-2: CHANGE NOTIFICATION REGISTER MAP FOR PIC24HJ128GP202/502, PIC24HJ64GP202/502 AND PIC24HJ32GP302

SFR Name	SFR Addr	Bit 15	Bit 14	Bit 13	Bit 12	Bit 11	Bit 10	Bit 9	Bit 8	Bit 7	Bit 6	Bit 5	Bit 4	Bit 3	Bit 2	Bit 1	Bit 0	All Resets
CNEN1	0060	CN15IE	CN14IE	CN13IE	CN12IE	CN11IE	—	—	—	CN7IE	CN6IE	CN5IE	CN4IE	CN3IE	CN2IE	CN1IE	CN0IE	0000
CNEN2	0062	—	CN30IE	CN29IE	—	CN27IE	—	—	CN24IE	CN23IE	CN22IE	CN21IE	—	—	—	—	CN16IE	0000
CNPU1	0068	CN15PUE	CN14PUE	CN13PUE	CN12PUE	CN11PUE	—	—	—	CN7PUE	CN6PUE	CN5PUE	CN4PUE	CN3PUE	CN2PUE	CN1PUE	CN0PUE	0000
CNPU2	006A	—	CN30PUE	CN29PUE	—	CN27PUE	—	—	CN24PUE	CN23PUE	CN22PUE	CN21PUE	—	—	—	—	CN16PUE	0000

Legend: x = unknown value on Reset, — = unimplemented, read as '0'. Reset values are shown in hexadecimal.

TABLE 4-3: CHANGE NOTIFICATION REGISTER MAP FOR PIC24HJ128GP204/504, PIC24HJ64GP204/504 AND PIC24HJ32GP304

SFR Name	SFR Addr	Bit 15	Bit 14	Bit 13	Bit 12	Bit 11	Bit 10	Bit 9	Bit 8	Bit 7	Bit 6	Bit 5	Bit 4	Bit 3	Bit 2	Bit 1	Bit 0	All Resets
CNEN1	0060	CN15IE	CN14IE	CN13IE	CN12IE	CN11IE	CN10IE	CN9IE	CN8IE	CN7IE	CN6IE	CN5IE	CN4IE	CN3IE	CN2IE	CN1IE	CN0IE	0000
CNEN2	0062	—	CN30IE	CN29IE	CN28IE	CN27IE	CN26IE	CN25IE	CN24IE	CN23IE	CN22IE	CN21IE	CN20IE	CN19IE	CN18IE	CN17IE	CN16IE	0000
CNPU1	0068	CN15PUE	CN14PUE	CN13PUE	CN12PUE	CN11PUE	CN10PUE	CN9PUE	CN8PUE	CN7PUE	CN6PUE	CN5PUE	CN4PUE	CN3PUE	CN2PUE	CN1PUE	CN0PUE	0000
CNPU2	006A	—	CN30PUE	CN29PUE	CN28PUE	CN27PUE	CN26PUE	CN25PUE	CN24PUE	CN23PUE	CN22PUE	CN21PUE	CN20PUE	CN19PUE	CN18PUE	CN17PUE	CN16PUE	0000

Legend: x = unknown value on Reset, — = unimplemented, read as '0'. Reset values are shown in hexadecimal.

TABLE 4-4: INTERRUPT CONTROLLER REGISTER MAP

SFR Name	SFR Addr	Bit 15	Bit 14	Bit 13	Bit 12	Bit 11	Bit 10	Bit 9	Bit 8	Bit 7	Bit 6	Bit 5	Bit 4	Bit 3	Bit 2	Bit 1	Bit 0	All Resets
INTCON1	0080	NSTDIS	—	—	—	—	—	—	—	—	DIV0ERR	DMACERR	MATHERR	ADDRERR	STKERR	OSCFAIL	—	0000
INTCON2	0082	ALTIVT	DISI	—	—	—	—	—	—	—	—	—	—	—	INT2EP	INT1EP	INT0EP	0000
IFS0	0084	—	DMA1IF	AD1IF	U1TXIF	U1RXIF	SPI1IF	SPI1EIF	T3IF	T2IF	OC2IF	IC2IF	DMA0IF	T1IF	OC1IF	IC1IF	INT0IF	0000
IFS1	0086	U2TXIF	U2RXIF	INT2IF	T5IF	T4IF	OC4IF	OC3IF	DMA2IF	IC8IF	IC7IF	—	INT1IF	CNIF	CMIF	MI2C1IF	SI2C1IF	0000
IFS2	0088	—	DMA4IF	PMPIF	—	—	—	—	—	—	—	—	DMA3IF	C1IF ⁽¹⁾	C1RXIF ⁽¹⁾	SPI2IF	SPI2EIF	0000
IFS3	008A	—	RTCIF	DMA5IF	—	—	—	—	—	—	—	—	—	—	—	—	—	0000
IFS4	008C	—	—	—	—	—	—	—	—	—	C1TXIF ⁽¹⁾	DMA7IF	DMA6IF	CRCIF	U2EIF	U1EIF	—	0000
IEC0	0094	—	DMA1IE	AD1IE	U1TXIE	U1RXIE	SPI1IE	SPI1EIE	T3IE	T2IE	OC2IE	IC2IE	DMA0IE	T1IE	OC1IE	IC1IE	INT0IE	0000
IEC1	0096	U2TXIE	U2RXIE	INT2IE	T5IE	T4IE	OC4IE	OC3IE	DMA2IE	IC8IE	IC7IE	—	INT1IE	CNIE	CMIE	MI2C1IE	SI2C1IE	0000
IEC2	0098	—	DMA4IE	PMPIE	—	—	—	—	—	—	—	—	DMA3IE	C1IE ⁽¹⁾	C1RXIE ⁽¹⁾	SPI2IE	SPI2EIE	0000
IEC3	009A	—	RTCIE	DMA5IE	—	—	—	—	—	—	—	—	—	—	—	—	—	0000
IEC4	009C	—	—	—	—	—	—	—	—	—	C1TXIE ⁽¹⁾	DMA7IE	DMA6IE	CRCIE	U2EIE	U1EIE	—	0000
IPC0	00A4	—	T1IP<2:0>			—	OC1IP<2:0>			—	IC1IP<2:0>			—	INT0IP<2:0>			4444
IPC1	00A6	—	T2IP<2:0>			—	OC2IP<2:0>			—	IC2IP<2:0>			—	DMA0IP<2:0>			4444
IPC2	00A8	—	U1RXIP<2:0>			—	SPI1IP<2:0>			—	SPI1EIP<2:0>			—	T3IP<2:0>			4444
IPC3	00AA	—	—	—	—	—	DMA1IP<2:0>			—	AD1IP<2:0>			—	U1TXIP<2:0>			0444
IPC4	00AC	—	CNIP<2:0>			—	CMIP<2:0>			—	MI2C1IP<2:0>			—	SI2C1IP<2:0>			4444
IPC5	00AE	—	IC8IP<2:0>			—	IC7IP<2:0>			—	—	—	—	—	INT1IP<2:0>			4404
IPC6	00B0	—	T4IP<2:0>			—	OC4IP<2:0>			—	OC3IP<2:0>			—	DMA2IP<2:0>			4444
IPC7	00B2	—	U2TXIP<2:0>			—	U2RXIP<2:0>			—	INT2IP<2:0>			—	T5IP<2:0>			4444
IPC8	00B4	—	C1IP<2:0> ⁽¹⁾			—	C1RXIP<2:0> ⁽¹⁾			—	SPI2IP<2:0>			—	SPI2EIP<2:0>			4444
IPC9	00B6	—	—	—	—	—	—	—	—	—	—	—	—	—	DMA3IP<2:0>			0004
IPC11	00BA	—	—	—	—	—	DMA4IP<2:0>			—	PMPIP<2:0>			—	—	—	—	0440
IPC15	00C2	—	—	—	—	—	RTCIP<2:0>			—	DMA5IP<2:0>			—	—	—	—	0440
IPC16	00C4	—	CRCIP<2:0>			—	U2EIP<2:0>			—	U1EIP<2:0>			—	—	—	—	4440
IPC17	00C6	—	—	—	—	—	C1TXIP<2:0> ⁽¹⁾			—	DMA7IP<2:0>			—	DMA6IP<2:0>			0444
INTTREG	00E0	—	—	—	—	—	ILR<3:0>			—	VECNUM<6:0>						4444	

Legend: x = unknown value on Reset, — = unimplemented, read as '0'. Reset values are shown in hexadecimal.

Note 1: Interrupts disabled on devices without ECAN™ modules.

TABLE 4-5: TIMER REGISTER MAP

SFR Name	SFR Addr	Bit 15	Bit 14	Bit 13	Bit 12	Bit 11	Bit 10	Bit 9	Bit 8	Bit 7	Bit 6	Bit 5	Bit 4	Bit 3	Bit 2	Bit 1	Bit 0	All Resets
TMR1	0100	Timer1 Register																0000
PR1	0102	Period Register 1																FFFF
T1CON	0104	TON	—	TSIDL	—	—	—	—	—	—	TGATE	TCKPS<1:0>	—	TSYNC	TCS	—	—	0000
TMR2	0106	Timer2 Register																0000
TMR3HLD	0108	Timer3 Holding Register (for 32-bit timer operations only)																xxxx
TMR3	010A	Timer3 Register																0000
PR2	010C	Period Register 2																FFFF
PR3	010E	Period Register 3																FFFF
T2CON	0110	TON	—	TSIDL	—	—	—	—	—	—	TGATE	TCKPS<1:0>	T32	—	TCS	—	—	0000
T3CON	0112	TON	—	TSIDL	—	—	—	—	—	—	TGATE	TCKPS<1:0>	—	—	TCS	—	—	0000
TMR4	0114	Timer4 Register																0000
TMR5HLD	0116	Timer5 Holding Register (for 32-bit timer operations only)																xxxx
TMR5	0118	Timer5 Register																0000
PR4	011A	Period Register 4																FFFF
PR5	011C	Period Register 5																FFFF
T4CON	011E	TON	—	TSIDL	—	—	—	—	—	—	TGATE	TCKPS<1:0>	T32	—	TCS	—	—	0000
T5CON	0120	TON	—	TSIDL	—	—	—	—	—	—	TGATE	TCKPS<1:0>	—	—	TCS	—	—	0000

Legend: x = unknown value on Reset, — = unimplemented, read as '0'. Reset values are shown in hexadecimal.

TABLE 4-6: INPUT CAPTURE REGISTER MAP

SFR Name	SFR Addr	Bit 15	Bit 14	Bit 13	Bit 12	Bit 11	Bit 10	Bit 9	Bit 8	Bit 7	Bit 6	Bit 5	Bit 4	Bit 3	Bit 2	Bit 1	Bit 0	All Resets
IC1BUF	0140	Input 1 Capture Register																xxxx
IC1CON	0142	—	—	ICSIDL	—	—	—	—	—	ICTMR	ICI<1:0>	ICOV	ICBNE	ICM<2:0>			0000	
IC2BUF	0144	Input 2 Capture Register																xxxx
IC2CON	0146	—	—	ICSIDL	—	—	—	—	—	ICTMR	ICI<1:0>	ICOV	ICBNE	ICM<2:0>			0000	
IC7BUF	0158	Input 7 Capture Register																xxxx
IC7CON	015A	—	—	ICSIDL	—	—	—	—	—	ICTMR	ICI<1:0>	ICOV	ICBNE	ICM<2:0>			0000	
IC8BUF	015C	Input 8 Capture Register																xxxx
IC8CON	015E	—	—	ICSIDL	—	—	—	—	—	ICTMR	ICI<1:0>	ICOV	ICBNE	ICM<2:0>			0000	

Legend: x = unknown value on Reset, — = unimplemented, read as '0'. Reset values are shown in hexadecimal.

TABLE 4-7: OUTPUT COMPARE REGISTER MAP

SFR Name	SFR Addr	Bit 15	Bit 14	Bit 13	Bit 12	Bit 11	Bit 10	Bit 9	Bit 8	Bit 7	Bit 6	Bit 5	Bit 4	Bit 3	Bit 2	Bit 1	Bit 0	All Resets
OC1RS	0180	Output Compare 1 Secondary Register																xxxx
OC1R	0182	Output Compare 1 Register																xxxx
OC1CON	0184	—	—	OCSIDL	—	—	—	—	—	—	—	—	OCFLT	OCTSEL	OCM<2:0>		0000	
OC2RS	0186	Output Compare 2 Secondary Register																xxxx
OC2R	0188	Output Compare 2 Register																xxxx
OC2CON	018A	—	—	OCSIDL	—	—	—	—	—	—	—	—	OCFLT	OCTSEL	OCM<2:0>		0000	
OC3RS	018C	Output Compare 3 Secondary Register																xxxx
OC3R	018E	Output Compare 3 Register																xxxx
OC3CON	0190	—	—	OCSIDL	—	—	—	—	—	—	—	—	OCFLT	OCTSEL	OCM<2:0>		0000	
OC4RS	0192	Output Compare 4 Secondary Register																xxxx
OC4R	0194	Output Compare 4 Register																xxxx
OC4CON	0196	—	—	OCSIDL	—	—	—	—	—	—	—	—	OCFLT	OCTSEL	OCM<2:0>		0000	

Legend: x = unknown value on Reset, — = unimplemented, read as '0'. Reset values are shown in hexadecimal.

TABLE 4-8: I2C1 REGISTER MAP

SFR Name	SFR Addr	Bit 15	Bit 14	Bit 13	Bit 12	Bit 11	Bit 10	Bit 9	Bit 8	Bit 7	Bit 6	Bit 5	Bit 4	Bit 3	Bit 2	Bit 1	Bit 0	All Resets
I2C1RCV	0200	—	—	—	—	—	—	—	—	Receive Register								0000
I2C1TRN	0202	—	—	—	—	—	—	—	—	Transmit Register								00FF
I2C1BRG	0204	—	—	—	—	—	—	—	Baud Rate Generator Register								0000	
I2C1CON	0206	I2CEN	—	I2CSIDL	SCLREL	IPMIEN	A10M	DISSLW	SMEN	GCEN	STREN	ACKDT	ACKEN	RCEN	PEN	RSEN	SEN	1000
I2C1STAT	0208	ACKSTAT	TRSTAT	—	—	—	BCL	GCSTAT	ADD10	IWCOL	I2COV	D_A	P	S	R_W	RBF	TBF	0000
I2C1ADD	020A	—	—	—	—	—	—	Address Register								0000		
I2C1MSK	020C	—	—	—	—	—	—	Address Mask Register								0000		

Legend: x = unknown value on Reset, — = unimplemented, read as '0'. Reset values are shown in hexadecimal.

TABLE 4-9: UART1 REGISTER MAP

SFR Name	SFR Addr	Bit 15	Bit 14	Bit 13	Bit 12	Bit 11	Bit 10	Bit 9	Bit 8	Bit 7	Bit 6	Bit 5	Bit 4	Bit 3	Bit 2	Bit 1	Bit 0	All Resets
U1MODE	0220	UARTEN	—	USIDL	IREN	RTSMO	—	UEN1	UEN0	WAKE	LPBACK	ABAUD	URXINV	BRGH	PDSEL<1:0>		STSEL	0000
U1STA	0222	UTXISEL1	UTXINV	UTXISEL0	—	UTXBRK	UTXEN	UTXBF	TRMT	URXISEL<1:0>		ADDEN	RIDLE	PERR	FERR	OERR	URXDA	0110
U1TXREG	0224	—	—	—	—	—	—	—	UTX8	UART Transmit Register								xxxx
U1RXREG	0226	—	—	—	—	—	—	—	URX8	UART Received Register								0000
U1BRG	0228	Baud Rate Generator Prescaler																0000

Legend: x = unknown value on Reset, — = unimplemented, read as '0'. Reset values are shown in hexadecimal.

TABLE 4-10: UART2 REGISTER MAP

SFR Name	SFR Addr	Bit 15	Bit 14	Bit 13	Bit 12	Bit 11	Bit 10	Bit 9	Bit 8	Bit 7	Bit 6	Bit 5	Bit 4	Bit 3	Bit 2	Bit 1	Bit 0	All Resets
U2MODE	0230	UARTEN	—	USIDL	IREN	RTSMO	—	UEN1	UEN0	WAKE	LPBACK	ABAUD	URXINV	BRGH	PDSEL<1:0>		STSEL	0000
U2STA	0232	UTXISEL1	UTXINV	UTXISEL0	—	UTXBRK	UTXEN	UTXBF	TRMT	URXISEL<1:0>		ADDEN	RIDLE	PERR	FERR	OERR	URXDA	0110
U2TXREG	0234	—	—	—	—	—	—	—	UTX8	UART Transmit Register								xxxx
U2RXREG	0236	—	—	—	—	—	—	—	URX8	UART Receive Register								0000
U2BRG	0238	Baud Rate Generator Prescaler																0000

Legend: x = unknown value on Reset, — = unimplemented, read as '0'. Reset values are shown in hexadecimal.

TABLE 4-11: SPI1 REGISTER MAP

SFR Name	SFR Addr	Bit 15	Bit 14	Bit 13	Bit 12	Bit 11	Bit 10	Bit 9	Bit 8	Bit 7	Bit 6	Bit 5	Bit 4	Bit 3	Bit 2	Bit 1	Bit 0	All Resets
SPI1STAT	0240	SPIEN	—	SPISIDL	—	—	—	—	—	—	SPIROV	—	—	—	—	SPITBF	SPIRBF	0000
SPI1CON1	0242	—	—	—	DISSCK	DISSDO	MODE16	SMP	CKE	SSEN	CKP	MSTEN	SPRE<2:0>		PPRE<1:0>		0000	
SPI1CON2	0244	FRMEN	SPIFSD	FRMPOL	—	—	—	—	—	—	—	—	—	—	—	FRMDLY	—	0000
SPI1BUF	0248	SPI1 Transmit and Receive Buffer Register																0000

Legend: x = unknown value on Reset, — = unimplemented, read as '0'. Reset values are shown in hexadecimal.

TABLE 4-12: SPI2 REGISTER MAP

SFR Name	SFR Addr	Bit 15	Bit 14	Bit 13	Bit 12	Bit 11	Bit 10	Bit 9	Bit 8	Bit 7	Bit 6	Bit 5	Bit 4	Bit 3	Bit 2	Bit 1	Bit 0	All Resets
SPI2STAT	0260	SPIEN	—	SPISIDL	—	—	—	—	—	—	SPIROV	—	—	—	—	SPITBF	SPIRBF	0000
SPI2CON1	0262	—	—	—	DISSCK	DISSDO	MODE16	SMP	CKE	SSEN	CKP	MSTEN	SPRE<2:0>		PPRE<1:0>		0000	
SPI2CON2	0264	FRMEN	SPIFSD	FRMPOL	—	—	—	—	—	—	—	—	—	—	—	FRMDLY	—	0000
SPI2BUF	0268	SPI2 Transmit and Receive Buffer Register																0000

Legend: x = unknown value on Reset, — = unimplemented, read as '0'. Reset values are shown in hexadecimal.

TABLE 4-13: ADC1 REGISTER MAP FOR PIC24HJ64GP202/502, PIC24HJ128GP202/502 AND PIC24HJ32GP302

File Name	Addr	Bit 15	Bit 14	Bit 13	Bit 12	Bit 11	Bit 10	Bit 9	Bit 8	Bit 7	Bit 6	Bit 5	Bit 4	Bit 3	Bit 2	Bit 1	Bit 0	All Resets			
ADC1BUF0	0300	ADC Data Buffer 0																	xxxx		
AD1CON1	0320	ADON	—	ADSIDL	ADDMABM	—	AD12B	FORM<1:0>	SSRC<2:0>		—	SIMSAM	ASAM	SAMP	DONE	0000					
AD1CON2	0322	VCFG<2:0>			—	—	CSCNA	CHPS<1:0>	BUFS	—	SMPI<3:0>				BUFM	ALTS	0000				
AD1CON3	0324	ADRC	—	—	SAMC<4:0>				ADCS<7:0>							0000					
AD1CHS123	0326	—	—	—	—	—	CH123NB<1:0>	CH123SB	—	—	—	—	—	—	CH123NA<1:0>	CH123SA	0000				
AD1CHS0	0328	CH0NB	—	—	CH0SB<4:0>				CH0NA	—	—	CH0SA<4:0>							0000		
AD1PCFGL	032C	—	—	—	PCFG12	PCFG11	PCFG10	PCFG9	—	—	—	PCFG5	PCFG4	PCFG3	PCFG2	PCFG1	PCFG0	0000			
AD1CSSL	0330	—	—	—	CSS12	CSS11	CSS10	CSS9	—	—	—	CSS5	CSS4	CSS3	CSS2	CSS1	CSS0	0000			
AD1CON4	0332	—	—	—	—	—	—	—	—	—	—	—	—	—	DMABL<2:0>			0000			

Legend: x = unknown value on Reset, — = unimplemented, read as '0'. Reset values are shown in hexadecimal.

TABLE 4-14: ADC1 REGISTER MAP FOR PIC24HJ64GP204/504, PIC24HJ128GP204/504 AND PIC24HJ32GP304

File Name	Addr	Bit 15	Bit 14	Bit 13	Bit 12	Bit 11	Bit 10	Bit 9	Bit 8	Bit 7	Bit 6	Bit 5	Bit 4	Bit 3	Bit 2	Bit 1	Bit 0	All Resets			
ADC1BUF0	0300	ADC Data Buffer 0																	xxxx		
AD1CON1	0320	ADON	—	ADSIDL	ADDMABM	—	AD12B	FORM<1:0>	SSRC<2:0>		—	SIMSAM	ASAM	SAMP	DONE	0000					
AD1CON2	0322	VCFG<2:0>			—	—	CSCNA	CHPS<1:0>	BUFS	—	SMPI<3:0>				BUFM	ALTS	0000				
AD1CON3	0324	ADRC	—	—	SAMC<4:0>				ADCS<7:0>							0000					
AD1CHS123	0326	—	—	—	—	—	CH123NB<1:0>	CH123SB	—	—	—	—	—	—	CH123NA<1:0>	CH123SA	0000				
AD1CHS0	0328	CH0NB	—	—	CH0SB<4:0>				CH0NA	—	—	CH0SA<4:0>							0000		
AD1PCFGL	032C	—	—	—	PCFG12	PCFG11	PCFG10	PCFG9	PCFG8	PCFG7	PCFG6	PCFG5	PCFG4	PCFG3	PCFG2	PCFG1	PCFG0	0000			
AD1CSSL	0330	—	—	—	CSS12	CSS11	CSS10	CSS9	CSS8	CSS7	CSS6	CSS5	CSS4	CSS3	CSS2	CSS1	CSS0	0000			
AD1CON4	0332	—	—	—	—	—	—	—	—	—	—	—	—	—	DMABL<2:0>			0000			

Legend: x = unknown value on Reset, — = unimplemented, read as '0'. Reset values are shown in hexadecimal.

TABLE 4-15: DMA REGISTER MAP

File Name	Addr	Bit 15	Bit 14	Bit 13	Bit 12	Bit 11	Bit 10	Bit 9	Bit 8	Bit 7	Bit 6	Bit 5	Bit 4	Bit 3	Bit 2	Bit 1	Bit 0	All Resets	
DMA0CON	0380	CHEN	SIZE	DIR	HALF	NULLW	—	—	—	—	—	AMODE<1:0>		—	—	MODE<1:0>		0000	
DMA0REQ	0382	FORCE	—	—	—	—	—	—	—	—	IRQSEL<6:0>								0000
DMA0STA	0384	STA<15:0>																0000	
DMA0STB	0386	STB<15:0>																0000	
DMA0PAD	0388	PAD<15:0>																0000	
DMA0CNT	038A	—	—	—	—	—	—	CNT<9:0>										0000	
DMA1CON	038C	CHEN	SIZE	DIR	HALF	NULLW	—	—	—	—	—	AMODE<1:0>		—	—	MODE<1:0>		0000	
DMA1REQ	038E	FORCE	—	—	—	—	—	—	—	—	IRQSEL<6:0>								0000
DMA1STA	0390	STA<15:0>																0000	
DMA1STB	0392	STB<15:0>																0000	
DMA1PAD	0394	PAD<15:0>																0000	
DMA1CNT	0396	—	—	—	—	—	—	CNT<9:0>										0000	
DMA2CON	0398	CHEN	SIZE	DIR	HALF	NULLW	—	—	—	—	—	AMODE<1:0>		—	—	MODE<1:0>		0000	
DMA2REQ	039A	FORCE	—	—	—	—	—	—	—	—	IRQSEL<6:0>								0000
DMA2STA	039C	STA<15:0>																0000	
DMA2STB	039E	STB<15:0>																0000	
DMA2PAD	03A0	PAD<15:0>																0000	
DMA2CNT	03A2	—	—	—	—	—	—	CNT<9:0>										0000	
DMA3CON	03A4	CHEN	SIZE	DIR	HALF	NULLW	—	—	—	—	—	AMODE<1:0>		—	—	MODE<1:0>		0000	
DMA3REQ	03A6	FORCE	—	—	—	—	—	—	—	—	IRQSEL<6:0>								0000
DMA3STA	03A8	STA<15:0>																0000	
DMA3STB	03AA	STB<15:0>																0000	
DMA3PAD	03AC	PAD<15:0>																0000	
DMA3CNT	03AE	—	—	—	—	—	—	CNT<9:0>										0000	
DMA4CON	03B0	CHEN	SIZE	DIR	HALF	NULLW	—	—	—	—	—	AMODE<1:0>		—	—	MODE<1:0>		0000	
DMA4REQ	03B2	FORCE	—	—	—	—	—	—	—	—	IRQSEL<6:0>								0000
DMA4STA	03B4	STA<15:0>																0000	
DMA4STB	03B6	STB<15:0>																0000	
DMA4PAD	03B8	PAD<15:0>																0000	
DMA4CNT	03BA	—	—	—	—	—	—	CNT<9:0>										0000	
DMA5CON	03BC	CHEN	SIZE	DIR	HALF	NULLW	—	—	—	—	—	AMODE<1:0>		—	—	MODE<1:0>		0000	
DMA5REQ	03BE	FORCE	—	—	—	—	—	—	—	—	IRQSEL<6:0>								0000
DMA5STA	03C0	STA<15:0>																0000	
DMA5STB	03C2	STB<15:0>																0000	

Legend: — = unimplemented, read as '0'. Reset values are shown in hexadecimal.

TABLE 4-15: DMA REGISTER MAP (CONTINUED)

File Name	Addr	Bit 15	Bit 14	Bit 13	Bit 12	Bit 11	Bit 10	Bit 9	Bit 8	Bit 7	Bit 6	Bit 5	Bit 4	Bit 3	Bit 2	Bit 1	Bit 0	All Resets	
DMA5PAD	03C4	PAD<15:0>																0000	
DMA5CNT	03C6	—	—	—	—	—	—	CNT<9:0>										0000	
DMA6CON	03C8	CHEN	SIZE	DIR	HALF	NULLW	—	—	—	—	—	AMODE<1:0>		—	—	MODE<1:0>		0000	
DMA6REQ	03CA	FORCE	—	—	—	—	—	—	—	—	IRQSEL<6:0>								0000
DMA6STA	03CC	STA<15:0>																0000	
DMA6STB	03CE	STB<15:0>																0000	
DMA6PAD	03D0	PAD<15:0>																0000	
DMA6CNT	03D2	—	—	—	—	—	—	CNT<9:0>										0000	
DMA7CON	03D4	CHEN	SIZE	DIR	HALF	NULLW	—	—	—	—	—	AMODE<1:0>		—	—	MODE<1:0>		0000	
DMA7REQ	03D6	FORCE	—	—	—	—	—	—	—	—	IRQSEL<6:0>								0000
DMA7STA	03D8	STA<15:0>																0000	
DMA7STB	03DA	STB<15:0>																0000	
DMA7PAD	03DC	PAD<15:0>																0000	
DMA7CNT	03DE	—	—	—	—	—	—	CNT<9:0>										0000	
DMACS0	03E0	PWCOL7	PWCOL6	PWCOL5	PWCOL4	PWCOL3	PWCOL2	PWCOL1	PWCOL0	XWCOL7	XWCOL6	XWCOL5	XWCOL4	XWCOL3	XWCOL2	XWCOL1	XWCOL0	0000	
DMACS1	03E2	—	—	—	—	LSTCH<3:0>				PPST7	PPST6	PPST5	PPST4	PPST3	PPST2	PPST1	PPST0	0000	
DSADR	03E4	DSADR<15:0>																0000	

Legend: — = unimplemented, read as '0'. Reset values are shown in hexadecimal.

TABLE 4-16: ECAN1 REGISTER MAP WHEN C1CTRL1.WIN = 0 OR 1 (FOR PIC24HJ128GP502/504 AND PIC24HJ64GP502/504)

File Name	Addr	Bit 15	Bit 14	Bit 13	Bit 12	Bit 11	Bit 10	Bit 9	Bit 8	Bit 7	Bit 6	Bit 5	Bit 4	Bit 3	Bit 2	Bit 1	Bit 0	All Resets
C1CTRL1	0400	—	—	CSIDL	ABAT	—	REQOP<2:0>		OPMODE<2:0>		—	CANCAP	—	—	—	—	WIN	0480
C1CTRL2	0402	—	—	—	—	—	—	—	—	—	—	—	—	DNCNT<4:0>				0000
C1VEC	0404	—	—	—	FILHIT<4:0>				—	ICODE<6:0>						0000		
C1FCTRL	0406	DMABS<2:0>			—	—	—	—	—	—	—	—	FSA<4:0>				0000	
C1FIFO	0408	—	—	FBP<5:0>					—	—	FNRB<5:0>					0000		
C1INTF	040A	—	—	TXBO	TXBP	RXBP	TXWAR	RXWAR	EWARN	IVRIF	WAKIF	ERRIF	—	FIFOIF	RBOVIF	RBIF	TBIF	0000
C1INTE	040C	—	—	—	—	—	—	—	—	IVRIE	WAKIE	ERRIE	—	FIFOIE	RBOVIE	RBIE	TBIE	0000
C1EC	040E	TERRCNT<7:0>					RERRCNT<7:0>									0000		
C1CFG1	0410	—	—	—	—	—	—	—	—	SJW<1:0>		BRP<5:0>						0000
C1CFG2	0412	—	WAKFIL	—	—	—	SEG2PH<2:0>			SEG2PHTS	SAM	SEG1PH<2:0>			PRSEG<2:0>			0000
C1FEN1	0414	FLTEN15	FLTEN14	FLTEN13	FLTEN12	FLTEN11	FLTEN10	FLTEN9	FLTEN8	FLTEN7	FLTEN6	FLTEN5	FLTEN4	FLTEN3	FLTEN2	FLTEN1	FLTEN0	FFFF
C1FMSKSEL1	0418	F7MSK<1:0>		F6MSK<1:0>		F5MSK<1:0>		F4MSK<1:0>		F3MSK<1:0>		F2MSK<1:0>		F1MSK<1:0>		F0MSK<1:0>		0000
C1FMSKSEL2	041A	F15MSK<1:0>		F14MSK<1:0>		F13MSK<1:0>		F12MSK<1:0>		F11MSK<1:0>		F10MSK<1:0>		F9MSK<1:0>		F8MSK<1:0>		0000

Legend: — = unimplemented, read as '0'. Reset values are shown in hexadecimal.

TABLE 4-17: ECAN1 REGISTER MAP WHEN C1CTRL1.WIN = 0 (FOR PIC24HJ128GP502/504 AND PIC24HJ64GP502/504)

File Name	Addr	Bit 15	Bit 14	Bit 13	Bit 12	Bit 11	Bit 10	Bit 9	Bit 8	Bit 7	Bit 6	Bit 5	Bit 4	Bit 3	Bit 2	Bit 1	Bit 0	All Resets
	0400-041E	See definition when WIN = x																
C1RXFUL1	0420	RXFUL15	RXFUL14	RXFUL13	RXFUL12	RXFUL11	RXFUL10	RXFUL9	RXFUL8	RXFUL7	RXFUL6	RXFUL5	RXFUL4	RXFUL3	RXFUL2	RXFUL1	RXFUL0	0000
C1RXFUL2	0422	RXFUL31	RXFUL30	RXFUL29	RXFUL28	RXFUL27	RXFUL26	RXFUL25	RXFUL24	RXFUL23	RXFUL22	RXFUL21	RXFUL20	RXFUL19	RXFUL18	RXFUL17	RXFUL16	0000
C1RXOVF1	0428	RXOVF15	RXOVF14	RXOVF13	RXOVF12	RXOVF11	RXOVF10	RXOVF9	RXOVF8	RXOVF7	RXOVF6	RXOVF5	RXOVF4	RXOVF3	RXOVF2	RXOVF1	RXOVF0	0000
C1RXOVF2	042A	RXOVF31	RXOVF30	RXOVF29	RXOVF28	RXOVF27	RXOVF26	RXOVF25	RXOVF24	RXOVF23	RXOVF22	RXOVF21	RXOVF20	RXOVF19	RXOVF18	RXOVF17	RXOVF16	0000
C1TR01CON	0430	TXEN1	TXABT1	TXLARB1	TXERR1	TXREQ1	RTREN1	TX1PRI<1:0>		TXEN0	TXABT0	TXLARB0	TXERR0	TXREQ0	RTREN0	TX0PRI<1:0>		0000
C1TR23CON	0432	TXEN3	TXABT3	TXLARB3	TXERR3	TXREQ3	RTREN3	TX3PRI<1:0>		TXEN2	TXABT2	TXLARB2	TXERR2	TXREQ2	RTREN2	TX2PRI<1:0>		0000
C1TR45CON	0434	TXEN5	TXABT5	TXLARB5	TXERR5	TXREQ5	RTREN5	TX5PRI<1:0>		TXEN4	TXABT4	TXLARB4	TXERR4	TXREQ4	RTREN4	TX4PRI<1:0>		0000
C1TR67CON	0436	TXEN7	TXABT7	TXLARB7	TXERR7	TXREQ7	RTREN7	TX7PRI<1:0>		TXEN6	TXABT6	TXLARB6	TXERR6	TXREQ6	RTREN6	TX6PRI<1:0>		0000
C1RXD	0440	Received Data Word																xxxx
C1TXD	0442	Transmit Data Word																xxxx

Legend: x = unknown value on Reset, — = unimplemented, read as '0'. Reset values are shown in hexadecimal.

TABLE 4-18: ECAN1 REGISTER MAP WHEN C1CTRL1.WIN = 1 (FOR PIC24HJ128GP502/504 AND PIC24HJ64GP502/504)

File Name	Addr	Bit 15	Bit 14	Bit 13	Bit 12	Bit 11	Bit 10	Bit 9	Bit 8	Bit 7	Bit 6	Bit 5	Bit 4	Bit 3	Bit 2	Bit 1	Bit 0	All Resets
	0400-041E	See definition when WIN = x																
C1BUFPNT1	0420	F3BP<3:0>			F2BP<3:0>			F1BP<3:0>			F0BP<3:0>						0000	
C1BUFPNT2	0422	F7BP<3:0>			F6BP<3:0>			F5BP<3:0>			F4BP<3:0>						0000	
C1BUFPNT3	0424	F11BP<3:0>			F10BP<3:0>			F9BP<3:0>			F8BP<3:0>						0000	
C1BUFPNT4	0426	F15BP<3:0>			F14BP<3:0>			F13BP<3:0>			F12BP<3:0>						0000	
C1RXM0SID	0430	SID<10:3>					SID<2:0>		—	MIDE	—	EID<17:16>					xxxx	
C1RXM0EID	0432	EID<15:8>					EID<7:0>										xxxx	
C1RXM1SID	0434	SID<10:3>					SID<2:0>		—	MIDE	—	EID<17:16>					xxxx	
C1RXM1EID	0436	EID<15:8>					EID<7:0>										xxxx	
C1RXM2SID	0438	SID<10:3>					SID<2:0>		—	MIDE	—	EID<17:16>					xxxx	
C1RXM2EID	043A	EID<15:8>					EID<7:0>										xxxx	
C1RXF0SID	0440	SID<10:3>					SID<2:0>		—	EXIDE	—	EID<17:16>					xxxx	
C1RXF0EID	0442	EID<15:8>					EID<7:0>										xxxx	
C1RXF1SID	0444	SID<10:3>					SID<2:0>		—	EXIDE	—	EID<17:16>					xxxx	
C1RXF1EID	0446	EID<15:8>					EID<7:0>										xxxx	
C1RXF2SID	0448	SID<10:3>					SID<2:0>		—	EXIDE	—	EID<17:16>					xxxx	
C1RXF2EID	044A	EID<15:8>					EID<7:0>										xxxx	
C1RXF3SID	044C	SID<10:3>					SID<2:0>		—	EXIDE	—	EID<17:16>					xxxx	
C1RXF3EID	044E	EID<15:8>					EID<7:0>										xxxx	
C1RXF4SID	0450	SID<10:3>					SID<2:0>		—	EXIDE	—	EID<17:16>					xxxx	
C1RXF4EID	0452	EID<15:8>					EID<7:0>										xxxx	
C1RXF5SID	0454	SID<10:3>					SID<2:0>		—	EXIDE	—	EID<17:16>					xxxx	
C1RXF5EID	0456	EID<15:8>					EID<7:0>										xxxx	
C1RXF6SID	0458	SID<10:3>					SID<2:0>		—	EXIDE	—	EID<17:16>					xxxx	
C1RXF6EID	045A	EID<15:8>					EID<7:0>										xxxx	
C1RXF7SID	045C	SID<10:3>					SID<2:0>		—	EXIDE	—	EID<17:16>					xxxx	
C1RXF7EID	045E	EID<15:8>					EID<7:0>										xxxx	
C1RXF8SID	0460	SID<10:3>					SID<2:0>		—	EXIDE	—	EID<17:16>					xxxx	
C1RXF8EID	0462	EID<15:8>					EID<7:0>										xxxx	
C1RXF9SID	0464	SID<10:3>					SID<2:0>		—	EXIDE	—	EID<17:16>					xxxx	
C1RXF9EID	0466	EID<15:8>					EID<7:0>										xxxx	
C1RXF10SID	0468	SID<10:3>					SID<2:0>		—	EXIDE	—	EID<17:16>					xxxx	
C1RXF10EID	046A	EID<15:8>					EID<7:0>										xxxx	

Legend: x = unknown value on Reset, — = unimplemented, read as '0'. Reset values are shown in hexadecimal.

TABLE 4-18: ECAN1 REGISTER MAP WHEN C1CTRL1.WIN = 1 (FOR PIC24HJ128GP502/504 AND PIC24HJ64GP502/504) (CONTINUED)

File Name	Addr	Bit 15	Bit 14	Bit 13	Bit 12	Bit 11	Bit 10	Bit 9	Bit 8	Bit 7	Bit 6	Bit 5	Bit 4	Bit 3	Bit 2	Bit 1	Bit 0	All Resets
C1RXF11SID	046C				SID<10:3>						SID<2:0>		—	EXIDE	—	EID<17:16>		xxxx
C1RXF11EID	046E				EID<15:8>						EID<7:0>							xxxx
C1RXF12SID	0470				SID<10:3>						SID<2:0>		—	EXIDE	—	EID<17:16>		xxxx
C1RXF12EID	0472				EID<15:8>						EID<7:0>							xxxx
C1RXF13SID	0474				SID<10:3>						SID<2:0>		—	EXIDE	—	EID<17:16>		xxxx
C1RXF13EID	0476				EID<15:8>						EID<7:0>							xxxx
C1RXF14SID	0478				SID<10:3>						SID<2:0>		—	EXIDE	—	EID<17:16>		xxxx
C1RXF14EID	047A				EID<15:8>						EID<7:0>							xxxx
C1RXF15SID	047C				SID<10:3>						SID<2:0>		—	EXIDE	—	EID<17:16>		xxxx
C1RXF15EID	047E				EID<15:8>						EID<7:0>							xxxx

Legend: x = unknown value on Reset, — = unimplemented, read as '0'. Reset values are shown in hexadecimal.

TABLE 4-19: PERIPHERAL PIN SELECT INPUT REGISTER MAP

File Name	Addr	Bit 15	Bit 14	Bit 13	Bit 12	Bit 11	Bit 10	Bit 9	Bit 8	Bit 7	Bit 6	Bit 5	Bit 4	Bit 3	Bit 2	Bit 1	Bit 0	All Resets
RPINR0	0680	—	—	—	INT1R<4:0>					—	—	—	—	—	—	—	—	1F00
RPINR1	0682	—	—	—	—	—	—	—	—	—	—	—	INT2R<4:0>					001F
RPINR3	0686	—	—	—	T3CKR<4:0>					—	—	—	T2CKR<4:0>					1F1F
RPINR4	0688	—	—	—	T5CKR<4:0>					—	—	—	T4CKR<4:0>					1F1F
RPINR7	068E	—	—	—	IC2R<4:0>					—	—	—	IC1R<4:0>					1F1F
RPINR10	0694	—	—	—	IC8R<4:0>					—	—	—	IC7R<4:0>					1F1F
RPINR11	0696	—	—	—	—	—	—	—	—	—	—	—	OCFAR<4:0>					001F
RPINR18	06A4	—	—	—	U1CTSR<4:0>					—	—	—	U1RXR<4:0>					1F1F
RPINR19	06A6	—	—	—	U2CTSR<4:0>					—	—	—	U2RXR<4:0>					1F1F
RPINR20	06A8	—	—	—	SCK1R<4:0>					—	—	—	SDI1R<4:0>					1F1F
RPINR21	06AA	—	—	—	—	—	—	—	—	—	—	—	SS1R<4:0>					001F
RPINR22	06AC	—	—	—	SCK2R<4:0>					—	—	—	SDI2R<4:0>					1F1F
RPINR23	06AE	—	—	—	—	—	—	—	—	—	—	—	SS2R<4:0>					001F
RPINR26 ⁽¹⁾	06B4	—	—	—	—	—	—	—	—	—	—	—	C1RXR<4:0>					001F

Legend: x = unknown value on Reset, — = unimplemented, read as '0'. Reset values are shown in hexadecimal.

Note 1: This register is present for PIC24HJ128GP502/504 and PIC24HJ64GP502/504 devices only.

TABLE 4-20: PERIPHERAL PIN SELECT OUTPUT REGISTER MAP FOR PIC24HJ128GP202/502, PIC24HJ64GP202/502 AND PIC24HJ32GP302

File Name	Addr	Bit 15	Bit 14	Bit 13	Bit 12	Bit 11	Bit 10	Bit 9	Bit 8	Bit 7	Bit 6	Bit 5	Bit 4	Bit 3	Bit 2	Bit 1	Bit 0	All Resets
RPOR0	06C0	—	—	—			RP1R<4:0>			—	—	—			RP0R<4:0>			0000
RPOR1	06C2	—	—	—			RP3R<4:0>			—	—	—			RP2R<4:0>			0000
RPOR2	06C4	—	—	—			RP5R<4:0>			—	—	—			RP4R<4:0>			0000
RPOR3	06C6	—	—	—			RP7R<4:0>			—	—	—			RP6R<4:0>			0000
RPOR4	06C8	—	—	—			RP9R<4:0>			—	—	—			RP8R<4:0>			0000
RPOR5	06CA	—	—	—			RP11R<4:0>			—	—	—			RP10R<4:0>			0000
RPOR6	06CC	—	—	—			RP13R<4:0>			—	—	—			RP12R<4:0>			0000
RPOR7	06CE	—	—	—			RP15R<4:0>			—	—	—			RP14R<4:0>			0000

Legend: x = unknown value on Reset, — = unimplemented, read as '0'. Reset values are shown in hexadecimal.

TABLE 4-21: PERIPHERAL PIN SELECT OUTPUT REGISTER MAP FOR PIC24HJ128GP204/504, PIC24HJ64GP204/504 AND PIC24HJ32GP304

File Name	Addr	Bit 15	Bit 14	Bit 13	Bit 12	Bit 11	Bit 10	Bit 9	Bit 8	Bit 7	Bit 6	Bit 5	Bit 4	Bit 3	Bit 2	Bit 1	Bit 0	All Resets
RPOR0	06C0	—	—	—			RP1R<4:0>			—	—	—			RP0R<4:0>			0000
RPOR1	06C2	—	—	—			RP3R<4:0>			—	—	—			RP2R<4:0>			0000
RPOR2	06C4	—	—	—			RP5R<4:0>			—	—	—			RP4R<4:0>			0000
RPOR3	06C6	—	—	—			RP7R<4:0>			—	—	—			RP6R<4:0>			0000
RPOR4	06C8	—	—	—			RP9R<4:0>			—	—	—			RP8R<4:0>			0000
RPOR5	06CA	—	—	—			RP11R<4:0>			—	—	—			RP10R<4:0>			0000
RPOR6	06CC	—	—	—			RP13R<4:0>			—	—	—			RP12R<4:0>			0000
RPOR7	06CE	—	—	—			RP15R<4:0>			—	—	—			RP14R<4:0>			0000
RPOR8	06D0	—	—	—			RP17R<4:0>			—	—	—			RP16R<4:0>			0000
RPOR9	06D2	—	—	—			RP19R<4:0>			—	—	—			RP18R<4:0>			0000
RPOR10	06D4	—	—	—			RP21R<4:0>			—	—	—			RP20R<4:0>			0000
RPOR11	06D6	—	—	—			RP23R<4:0>			—	—	—			RP22R<4:0>			0000
RPOR12	06D8	—	—	—			RP25R<4:0>			—	—	—			RP24R<4:0>			0000

Legend: x = unknown value on Reset, — = unimplemented, read as '0'. Reset values are shown in hexadecimal.

TABLE 4-22: PARALLEL MASTER/SLAVE PORT REGISTER MAP FOR PIC24HPIC24HJ128GP202/502, PIC24HJ64GP202/502 AND PIC24HJ32GP302

File Name	Addr	Bit 15	Bit 14	Bit 13	Bit 12	Bit 11	Bit 10	Bit 9	Bit 8	Bit 7	Bit 6	Bit 5	Bit 4	Bit 3	Bit 2	Bit 1	Bit 0	All Resets
PMCON	0600	PMPEN	—	PSIDL	ADRMUX<1:0>		PTBEEN	PTWREN	PTRDEN	CSF1	CSF0	ALP	—	CS1P	BEP	WRSP	RDSP	0000
PMMODE	0602	BUSY	IRQM<1:0>		INCM<1:0>		MODE16	MODE<1:0>		WAITB<1:0>		WAITM<3:0>			WAITE<1:0>		0000	
PMADDR	0604	ADDR15	CS1	ADDR<13:0>														0000
PMDOUT1		Parallel Port Data Out Register 1 (Buffers 0 and 1)																0000
PMDOUT2	0606	Parallel Port Data Out Register 2 (Buffers 2 and 3)																0000
PMDIN1	0608	Parallel Port Data In Register 1 (Buffers 0 and 1)																0000
PMPDIN2	060A	Parallel Port Data In Register 2 (Buffers 2 and 3)																0000
PMAEN	060C	—	PTEN14	—	—	—	—	—	—	—	—	—	—	—	—	PTEN<1:0>		0000
PMSTAT	060E	IBF	IBOV	—	—	IB3F	IB2F	IB1F	IB0F	OBE	OBUF	—	—	OB3E	OB2E	OB1E	OB0E	008F

Legend: — = unimplemented, read as '0'. Reset values are shown in hexadecimal.

TABLE 4-23: PARALLEL MASTER/SLAVE PORT REGISTER MAP FOR PIC24HJ128GP204/504, PIC24HJ64GP204/504 AND PIC24HJ32GP304

File Name	Addr	Bit 15	Bit 14	Bit 13	Bit 12	Bit 11	Bit 10	Bit 9	Bit 8	Bit 7	Bit 6	Bit 5	Bit 4	Bit 3	Bit 2	Bit 1	Bit 0	All Resets
PMCON	0600	PMPEN	—	PSIDL	ADRMUX<1:0>		PTBEEN	PTWREN	PTRDEN	CSF1	CSF0	ALP	—	CS1P	BEP	WRSP	RDSP	0000
PMMODE	0602	BUSY	IRQM<1:0>		INCM<1:0>		MODE16	MODE<1:0>		WAITB<1:0>		WAITM<3:0>			WAITE<1:0>		0000	
PMADDR	0604	ADDR15	CS1	ADDR<13:0>														0000
PMDOUT1		Parallel Port Data Out Register 1 (Buffers 0 and 1)																0000
PMDOUT2	0606	Parallel Port Data Out Register 2 (Buffers 2 and 3)																0000
PMDIN1	0608	Parallel Port Data In Register 1 (Buffers 0 and 1)																0000
PMPDIN2	060A	Parallel Port Data In Register 2 (Buffers 2 and 3)																0000
PMAEN	060C	—	PTEN14	—	—	—	PTEN<10:0>											0000
PMSTAT	060E	IBF	IBOV	—	—	IB3F	IB2F	IB1F	IB0F	OBE	OBUF	—	—	OB3E	OB2E	OB1E	OB0E	008F

Legend: — = unimplemented, read as '0'. Reset values are shown in hexadecimal.

TABLE 4-24: REAL-TIME CLOCK AND CALENDAR REGISTER MAP

File Name	Addr	Bit 15	Bit 14	Bit 13	Bit 12	Bit 11	Bit 10	Bit 9	Bit 8	Bit 7	Bit 6	Bit 5	Bit 4	Bit 3	Bit 2	Bit 1	Bit 0	All Resets	
ALRMVAL	0620	Alarm Value Register Window based on APTR<1:0>																xxxx	
ALCFGRPT	0622	ALRMEN	CHIME	AMASK<3:0>				ALRMPTR<1:0>			ARPT<7:0>						0000		
RTCVAL	0624	RTCC Value Register Window based on RTCPTR<1:0>																xxxx	
RCFGAL	0626	RTCEN	—	RTCWREN	RTCSYNC	HALFSEC	RTCOE	RTCPTR<1:0>			CAL<7:0>						0000		
PADCFG1	02FC	—	—	—	—	—	—	—	—	—	—	—	—	—	—	—	RTSESEL	PMPTTL	0000

Legend: x = unknown value on Reset, — = unimplemented, read as '0'. Reset values are shown in hexadecimal.

TABLE 4-25: CRC REGISTER MAP

File Name	Addr	Bit 15	Bit 14	Bit 13	Bit 12	Bit 11	Bit 10	Bit 9	Bit 8	Bit 7	Bit 6	Bit 5	Bit 4	Bit 3	Bit 2	Bit 1	Bit 0	All Resets
CRCCON	0640	—	—	CSIDL	VWORD<4:0>				CRCFUL	CRCMPT	—	CRCGO	PLEN<3:0>					0000
CRCXOR	0642	X<15:0>																0000
CRCDAT	0644	CRC Data Input Register																0000
CRCWDAT	0646	CRC Result Register																0000

Legend: — = unimplemented, read as '0'. Reset values are shown in hexadecimal.

TABLE 4-26: DUAL COMPARATOR REGISTER MAP

File Name	Addr	Bit 15	Bit 14	Bit 13	Bit 12	Bit 11	Bit 10	Bit 9	Bit 8	Bit 7	Bit 6	Bit 5	Bit 4	Bit 3	Bit 2	Bit 1	Bit 0	All Resets
CMCON	0630	CMIDL	—	C2EVT	C1EVT	C2EN	C1EN	C2OUTEN	C1OUTEN	C2OUT	C1OUT	C2INV	C1INV	C2NEG	C2POS	C1NEG	C1POS	0000
CVRCON	0632	—	—	—	—	—	—	—	—	CVREN	CVROE	CVRR	CVRSS	CVR<3:0>			0000	

Legend: — = unimplemented, read as '0'. Reset values are shown in hexadecimal.

TABLE 4-27: PORTA REGISTER MAP FOR PIC24HJ128GP202/502, PIC24HJ64GP202/502 AND PIC24HJ32GP302

File Name	Addr	Bit 15	Bit 14	Bit 13	Bit 12	Bit 11	Bit 10	Bit 9	Bit 8	Bit 7	Bit 6	Bit 5	Bit 4	Bit 3	Bit 2	Bit 1	Bit 0	All Resets
TRISA	02C0	—	—	—	—	—	—	—	—	—	—	—	TRISA4	TRISA3	TRISA2	TRISA1	TRISA0	001F
PORTA	02C2	—	—	—	—	—	—	—	—	—	—	—	RA4	RA3	RA2	RA1	RA0	xxxx
LATA	02C4	—	—	—	—	—	—	—	—	—	—	—	LATA4	LATA3	LATA2	LATA1	LATA0	xxxx
ODCA	02C6	—	—	—	—	—	—	—	—	—	—	—	—	—	—	—	—	0000

Legend: x = unknown value on Reset, — = unimplemented, read as '0'. Reset values are shown in hexadecimal.

TABLE 4-28: PORTA REGISTER MAP FOR PIC24HJ128GP204/504, PIC24HJ64GP204/504 AND PIC24HJ32GP304

File Name	Addr	Bit 15	Bit 14	Bit 13	Bit 12	Bit 11	Bit 10	Bit 9	Bit 8	Bit 7	Bit 6	Bit 5	Bit 4	Bit 3	Bit 2	Bit 1	Bit 0	All Resets
TRISA	02C0	—	—	—	—	—	TRISA10	TRISA9	TRISA8	TRISA7	—	—	TRISA4	TRISA3	TRISA2	TRISA1	TRISA0	079F
PORTA	02C2	—	—	—	—	—	RA10	RA9	RA8	RA7	—	—	RA4	RA3	RA2	RA1	RA0	xxxx
LATA	02C4	—	—	—	—	—	LATA10	LATA9	LATA8	LATA7	—	—	LATA4	LATA3	LATA2	LATA1	LATA0	xxxx
ODCA	02C6	—	—	—	—	—	ODCA10	ODCA9	ODCA8	ODCA7	—	—	—	—	—	—	—	0000

Legend: x = unknown value on Reset, — = unimplemented, read as '0'. Reset values are shown in hexadecimal.

TABLE 4-29: PORTB REGISTER MAP

File Name	Addr	Bit 15	Bit 14	Bit 13	Bit 12	Bit 11	Bit 10	Bit 9	Bit 8	Bit 7	Bit 6	Bit 5	Bit 4	Bit 3	Bit 2	Bit 1	Bit 0	All Resets
TRISB	02C8	TRISB15	TRISB14	TRISB13	TRISB12	TRISB11	TRISB10	TRISB9	TRISB8	TRISB7	TRISB6	TRISB5	TRISB4	TRISB3	TRISB2	TRISB1	TRISB0	FFFF
PORTB	02CA	RB15	RB14	RB13	RB12	RB11	RB10	RB9	RB8	RB7	RB6	RB5	RB4	RB3	RB2	RB1	RB0	xxxx
LATB	02CC	LATB15	LATB14	LATB13	LATB12	LATB11	LATB10	LATB9	LATB8	LATB7	LATB6	LATB5	LATB4	LATB3	LATB2	LATB1	LATB0	xxxx
ODCB	02CE	—	—	—	—	ODCB11	ODCB10	ODCB9	ODCB8	ODCB7	ODCB6	ODCB5	—	—	—	—	—	0000

Legend: x = unknown value on Reset, — = unimplemented, read as '0'. Reset values are shown in hexadecimal.

TABLE 4-30: PORTC REGISTER MAP FOR PIC24HJ128GP204/504, PIC24HJ64GP204/504 AND PIC24HJ32GP304

File Name	Addr	Bit 15	Bit 14	Bit 13	Bit 12	Bit 11	Bit 10	Bit 9	Bit 8	Bit 7	Bit 6	Bit 5	Bit 4	Bit 3	Bit 2	Bit 1	Bit 0	All Resets
TRISC	02D0	—	—	—	—	—	—	TRISC9	TRISC8	TRISC7	TRISC6	TRISC5	TRISC4	TRISC3	TRISC2	TRISC1	TRISC0	03FF
PORTC	02D2	—	—	—	—	—	—	RC9	RC8	RC7	RC6	RC5	RC4	RC3	RC2	RC1	RC0	xxxx
LATC	02D4	—	—	—	—	—	—	LATC9	LATC8	LATC7	LATC6	LATC5	LATC4	LATC3	LATC2	LATC1	LATC0	xxxx
ODCC	02D6	—	—	—	—	—	—	ODCC9	ODCC8	ODCC7	ODCC6	ODCC5	ODCC4	ODCC3	—	—	—	0000

Legend: x = unknown value on Reset, — = unimplemented, read as '0'. Reset values are shown in hexadecimal.

TABLE 4-31: SYSTEM CONTROL REGISTER MAP

File Name	Addr	Bit 15	Bit 14	Bit 13	Bit 12	Bit 11	Bit 10	Bit 9	Bit 8	Bit 7	Bit 6	Bit 5	Bit 4	Bit 3	Bit 2	Bit 1	Bit 0	All Resets	
RCON	0740	TRAPR	IOPUWR	—	—	—	—	CM	VREGS	EXTR	SWR	SWDTEN	WDTO	SLEEP	IDLE	BOR	POR	xxxx ⁽¹⁾	
OSCCON	0742	—	COSC<2:0>				—	NOSC<2:0>			CLKLOCK	IOLOCK	LOCK	—	CF	—	LPOSCEN	OSWEN	0300 ⁽²⁾
CLKDIV	0744	ROI	DOZE<2:0>			DOZEN	FRCDIV<2:0>			PLLPOST<1:0>		—	PLLPRE<4:0>					3040	
PLLFBD	0746	—	—	—	—	—	—	—	PLLDIV<8:0>									0030	
OSCTUN	0748	—	—	—	—	—	—	—	—	—	—	TUN<5:0>						0000	

Legend: x = unknown value on Reset, — = unimplemented, read as '0'. Reset values are shown in hexadecimal.

Note 1: RCON register Reset values dependent on type of Reset.

Note 2: OSCCON register Reset values dependent on the FOSC Configuration bits and by type of Reset.

TABLE 4-32: SECURITY REGISTER MAP⁽¹⁾

File Name	Addr	Bit 15	Bit 14	Bit 13	Bit 12	Bit 11	Bit 10	Bit 9	Bit 8	Bit 7	Bit 6	Bit 5	Bit 4	Bit 3	Bit 2	Bit 1	Bit 0	All Resets
BSRAM	0750	—	—	—	—	—	—	—	—	—	—	—	—	—	IW_BSR	IR_BSR	RL_BSR	0000
SSRAM	0752	—	—	—	—	—	—	—	—	—	—	—	—	—	IW_SSR	IR_SSR	RL_SSR	0000

Legend: x = unknown value on Reset, — = unimplemented, read as '0'. Reset values are shown in hexadecimal.

Note 1: This register is not present in devices with 32K Flash (PIC24HJ32GP302/304).

TABLE 4-33: NVM REGISTER MAP

File Name	Addr	Bit 15	Bit 14	Bit 13	Bit 12	Bit 11	Bit 10	Bit 9	Bit 8	Bit 7	Bit 6	Bit 5	Bit 4	Bit 3	Bit 2	Bit 1	Bit 0	All Resets
NVMCON	0760	WR	WREN	WRERR	—	—	—	—	—	—	ERASE	—	—	NVMOP<3:0>			0000	
NVMKEY	0766	—	—	—	—	—	—	—	—	NVMKEY<7:0>								0000

Legend: x = unknown value on Reset, — = unimplemented, read as '0'. Reset values are shown in hexadecimal.

TABLE 4-34: PMD REGISTER MAP

File Name	Addr	Bit 15	Bit 14	Bit 13	Bit 12	Bit 11	Bit 10	Bit 9	Bit 8	Bit 7	Bit 6	Bit 5	Bit 4	Bit 3	Bit 2	Bit 1	Bit 0	All Resets
PMD1	0770	T5MD	T4MD	T3MD	T2MD	T1MD	—	—	—	I2C1MD	U2MD	U1MD	SPI2MD	SPI1MD	—	C1MD	AD1MD	0000
PMD2	0772	IC8MD	IC7MD	—	—	—	—	IC2MD	IC1MD	—	—	—	—	OC4MD	OC3MD	OC2MD	OC1MD	0000
PMD3	0774	—	—	—	—	—	CMPMD	RTCCMD	PMPMD	CRCMD	—	—	—	—	—	—	—	0000

Legend: x = unknown value on Reset, — = unimplemented, read as '0'. Reset values are shown in hexadecimal.

4.4.1 SOFTWARE STACK

In addition to its use as a working register, the W15 register in the PIC24HJ32GP302/304, PIC24HJ64GPX02/X04 and PIC24HJ128GPX02/X04 devices is also used as a software Stack Pointer. The Stack Pointer always points to the first available free word and grows from lower to higher addresses. It pre-decrements for stack pops and post-increments for stack pushes, as shown in Figure 4-5. For a PC push during any CALL instruction, the MSb of the PC is zero-extended before the push, ensuring that the MSb is always clear.

Note: A PC push during exception processing concatenates the SRL register to the MSb of the PC prior to the push.

The Stack Pointer Limit register (SPLIM) associated with the Stack Pointer sets an upper address boundary for the stack. SPLIM is uninitialized at Reset. As is the case for the Stack Pointer, SPLIM<0> is forced to '0' because all stack operations must be word aligned.

Whenever an EA is generated using W15 as a source or destination pointer, the resulting address is compared with the value in SPLIM. If the contents of the Stack Pointer (W15) and the SPLIM register are equal and a push operation is performed, a stack error trap does not occur. The stack error trap occurs on a subsequent push operation. For example, to cause a stack error trap when the stack grows beyond address 0x2000 in RAM, initialize the SPLIM with the value 0x1FFE.

Similarly, a Stack Pointer underflow (stack error) trap is generated when the Stack Pointer address is found to be less than 0x0800. This prevents the stack from interfering with the Special Function Register (SFR) space.

A write to the SPLIM register should not be immediately followed by an indirect read operation using W15.

FIGURE 4-5: CALL STACK FRAME



4.4.2 DATA RAM PROTECTION FEATURE

The PIC24H product family supports Data RAM protection features that enable segments of RAM to be protected when used in conjunction with Boot and Secure Code Segment Security. BSRAM (Secure RAM segment for BS) is accessible only from the Boot Segment Flash code when enabled. SSRAM (Secure RAM segment for RAM) is accessible only from the Secure Segment Flash code when enabled. See Table 4-1 for an overview of the BSRAM and SSRAM SFRs.

4.5 Instruction Addressing Modes

The addressing modes shown in Table 4-35 form the basis of the addressing modes optimized to support the specific features of individual instructions. The addressing modes provided in the MAC class of instructions differ from those in the other instruction types.

4.5.1 FILE REGISTER INSTRUCTIONS

Most file register instructions use a 13-bit address field (f) to directly address data present in the first 8192 bytes of data memory (near data space). Most file register instructions employ a working register, W0, which is denoted as WREG in these instructions. The destination is typically either the same file register or WREG (with the exception of the MUL instruction), which writes the result to a register or register pair. The MOV instruction allows additional flexibility and can access the entire data space.

4.5.2 MCU INSTRUCTIONS

The three-operand MCU instructions are of the form:

Operand 3 = Operand 1 <function> Operand 2
where:

Operand 1 is always a working register (that is, the addressing mode can only be register direct), which is referred to as Wb.

Operand 2 can be a W register, fetched from data memory, or a 5-bit literal. The result location can be either a W register or a data memory location. The following addressing modes are supported by MCU instructions:

- Register Direct
- Register Indirect
- Register Indirect Post-Modified
- Register Indirect Pre-Modified
- 5-bit or 10-bit Literal

Note: Not all instructions support all the addressing modes given above. Individual instructions can support different subsets of these addressing modes.

TABLE 4-35: FUNDAMENTAL ADDRESSING MODES SUPPORTED

Addressing Mode	Description
File Register Direct	The address of the file register is specified explicitly.
Register Direct	The contents of a register are accessed directly.
Register Indirect	The contents of Wn forms the Effective Address (EA).
Register Indirect Post-Modified	The contents of Wn forms the EA. Wn is post-modified (incremented or decremented) by a constant value.
Register Indirect Pre-Modified	Wn is pre-modified (incremented or decremented) by a signed constant value to form the EA.
Register Indirect with Register Offset (Register Indexed)	The sum of Wn and Wb forms the EA.
Register Indirect with Literal Offset	The sum of Wn and a literal forms the EA.

4.5.3 MOVE (MOV) INSTRUCTION

Move instructions provide a greater degree of addressing flexibility than other instructions. In addition to the Addressing modes supported by most MCU instructions, MOV instructions also support Register Indirect with Register Offset Addressing mode, also referred to as Register Indexed mode.

Note: For the MOV instructions, the addressing mode specified in the instruction can differ for the source and destination EA. However, the 4-bit Wb (Register Offset) field is shared by both source and destination (but typically only used by one).

In summary, the following addressing modes are supported by move instructions:

- Register Direct
- Register Indirect
- Register Indirect Post-modified
- Register Indirect Pre-modified
- Register Indirect with Register Offset (Indexed)
- Register Indirect with Literal Offset
- 8-bit Literal
- 16-bit Literal

Note: Not all instructions support all the addressing modes given above. Individual instructions may support different subsets of these addressing modes.

4.5.4 OTHER INSTRUCTIONS

Besides the addressing modes outlined previously, some instructions use literal constants of various sizes. For example, BRA (branch) instructions use 16-bit signed literals to specify the branch destination directly, whereas the DISI instruction uses a 14-bit unsigned literal field. In some instructions, such as ADD ACC, the source of an operand or result is implied by the opcode itself. Certain operations, such as NOP, do not have any operands.

4.6 Interfacing Program and Data Memory Spaces

The PIC24HJ32GP302/304, PIC24HJ64GPX02/X04 and PIC24HJ128GPX02/X04 architecture uses a 24-bit-wide program space and a 16-bit-wide data space. The architecture is also a modified Harvard scheme, meaning that data can also be present in the program space. To use this data successfully, it must be accessed in a way that preserves the alignment of information in both spaces.

Aside from normal execution, the PIC24HJ32GP302/304, PIC24HJ64GPX02/X04 and PIC24HJ128GPX02/X04 architecture provides two methods by which program space can be accessed during operation:

- Using table instructions to access individual bytes or words anywhere in the program space
- Remapping a portion of the program space into the data space (Program Space Visibility)

Table instructions allow an application to read or write to small areas of the program memory. This capability makes the method ideal for accessing data tables that need to be updated periodically. It also allows access to all bytes of the program word. The remapping method allows an application to access a large block of data on a read-only basis, which is ideal for look-ups from a large table of static data. The application can only access the least significant word of the program word.

4.6.1 ADDRESSING PROGRAM SPACE

Since the address ranges for the data and program spaces are 16 and 24 bits, respectively, a method is needed to create a 23-bit or 24-bit program address from 16-bit data registers. The solution depends on the interface method to be used.

For table operations, the 8-bit Table Page register (TBLPAG) is used to define a 32K word region within the program space. This is concatenated with a 16-bit EA to arrive at a full 24-bit program space address. In this format, the Most Significant bit (MSb) of TBLPAG is used to determine if the operation occurs in the user memory (TBLPAG<7> = 0) or the configuration memory (TBLPAG<7> = 1).

For remapping operations, the 8-bit Program Space Visibility register (PSVPAG) is used to define a 16K word page in the program space. When the MSb of the EA is '1', PSVPAG is concatenated with the lower 15 bits of the EA to form a 23-bit program space address. Unlike table operations, this limits remapping operations strictly to the user memory area.

Table 4-36 and Figure 4-6 show how the program EA is created for table operations and remapping accesses from the data EA. Here, P<23:0> refers to a program space word, and D<15:0> refers to a data space word.

TABLE 4-36: PROGRAM SPACE ADDRESS CONSTRUCTION

Access Type	Access Space	Program Space Address				
		<23>	<22:16>	<15>	<14:1>	<0>
Instruction Access (Code Execution)	User	0	PC<22:1>			0
		0xx xxxx xxxxx xxxxx xxxxx xxx0				
TBLRD/TBLWT (Byte/Word Read/Write)	User	TBLPAG<7:0>		Data EA<15:0>		
		0xxx xxxxx xxxxx xxxxx xxxxx xxxxx				
	Configuration	TBLPAG<7:0>		Data EA<15:0>		
		1xxx xxxxx xxxxx xxxxx xxxxx xxxxx				
Program Space Visibility (Block Remap/Read)	User	0	PSVPAG<7:0>		Data EA<14:0> ⁽¹⁾	
		0	xxxx xxxxx		xxx xxxxx xxxxx xxxxx	

Note 1: Data EA<15> is always '1' in this case, but is not used in calculating the program space address. Bit 15 of the address is PSVPAG<0>.

FIGURE 4-6: DATA ACCESS FROM PROGRAM SPACE ADDRESS GENERATION



4.6.2 DATA ACCESS FROM PROGRAM MEMORY USING TABLE INSTRUCTIONS

The `TBLRDL` and `TBLWTL` instructions offer a direct method of reading or writing the lower word of any address within the program space without going through data space. The `TBLRDH` and `TBLWTH` instructions are the only method to read or write the upper 8 bits of a program space word as data.

The PC is incremented by two for each successive 24-bit program word. This allows program memory addresses to directly map to data space addresses. Program memory can thus be regarded as two 16-bit wide word address spaces, residing side by side, each with the same address range. `TBLRDL` and `TBLWTL` access the space that contains the least significant data word. `TBLRDH` and `TBLWTH` access the space that contains the upper data byte.

Two table instructions are provided to move byte or word-sized (16-bit) data to and from program space. Both function as either byte or word operations.

- `TBLRDL` (Table Read Low):
 - In Word mode, this instruction maps the lower word of the program space location ($P<15:0>$) to a data address ($D<15:0>$).

- In Byte mode, either the upper or lower byte of the lower program word is mapped to the lower byte of a data address. The upper byte is selected when Byte Select is '1'; the lower byte is selected when it is '0'.

- `TBLRDH` (Table Read High):
 - In Word mode, this instruction maps the entire upper word of a program address ($P<23:16>$) to a data address. The 'phantom' byte ($D<15:8>$), is always '0'.
 - In Byte mode, this instruction maps the upper or lower byte of the program word to $D<7:0>$ of the data address, in the `TBLRDL` instruction. The data is always '0' when the upper 'phantom' byte is selected (Byte Select = 1).

Similarly, two table instructions, `TBLWTH` and `TBLWTL`, are used to write individual bytes or words to a program space address. The details of their operation are explained in [Section 5.0 "Flash Program Memory"](#).

For all table operations, the area of program memory space to be accessed is determined by the Table Page register (`TBLPAG`). `TBLPAG` covers the entire program memory space of the device, including user application and configuration spaces. When $TBLPAG<7> = 0$, the table page is located in the user memory space. When $TBLPAG<7> = 1$, the page is located in configuration space.

FIGURE 4-7: ACCESSING PROGRAM MEMORY WITH TABLE INSTRUCTIONS



4.6.3 READING DATA FROM PROGRAM MEMORY USING PROGRAM SPACE VISIBILITY

The upper 32 Kbytes of data space may optionally be mapped into any 16K word page of the program space. This option provides transparent access to stored constant data from the data space without the need to use special instructions, such as `TBLRDL`/`TBLRDH`.

Program space access through the data space occurs if the MSb of the data space EA is '1' and program space visibility is enabled by setting the PSV bit in the Core Control register (`CORCON<2>`). The location of the program memory space to be mapped into the data space is determined by the Program Space Visibility Page register (`PSVPAG`). This 8-bit register defines any one of 256 possible pages of 16K words in program space. In effect, `PSVPAG` functions as the upper 8 bits of the program memory address, with the 15 bits of the EA functioning as the lower bits. By incrementing the PC by 2 for each program memory word, the lower 15 bits of data space addresses directly map to the lower 15 bits in the corresponding program space addresses.

Data reads to this area add a cycle to the instruction being executed, since two program memory fetches are required.

Although each data space address 0x8000 and higher maps directly into a corresponding program memory address (see [Figure 4-8](#)), only the lower 16 bits of the

24-bit program word are used to contain the data. The upper 8 bits of any program space location used as data should be programmed with '1111 1111' or '0000 0000' to force a `NOP`. This prevents possible issues should the area of code ever be accidentally executed.

Note: PSV access is temporarily disabled during table reads/writes.

For operations that use PSV and are executed outside a `REPEAT` loop, the `MOV` and `MOV.D` instructions require one instruction cycle in addition to the specified execution time. All other instructions require two instruction cycles in addition to the specified execution time.

For operations that use PSV, and are executed inside a `REPEAT` loop, these instances require two instruction cycles in addition to the specified execution time of the instruction:

- Execution in the first iteration
- Execution in the last iteration
- Execution prior to exiting the loop due to an interrupt
- Execution upon re-entering the loop after an interrupt is serviced

Any other iteration of the `REPEAT` loop allows the instruction using PSV to access data, to execute in a single cycle.

FIGURE 4-8: PROGRAM SPACE VISIBILITY OPERATION



5.0 FLASH PROGRAM MEMORY

Note 1: This data sheet summarizes the features of the PIC24HJ32GP302/304, PIC24HJ64GPX02/X04 and PIC24HJ128GPX02/X04 families of devices. It is not intended to be a comprehensive reference source. To complement the information in this data sheet, refer to **Section 5. “Flash Programming”** (DS70191) of the “dsPIC33F/PIC24H Family Reference Manual”, which is available from the Microchip web site (www.microchip.com).

2: Some registers and associated bits described in this section may not be available on all devices. Refer to **Section 4.0 “Memory Organization”** in this data sheet for device-specific register and bit information.

The PIC24HJ32GP302/304, PIC24HJ64GPX02/X04 and PIC24HJ128GPX02/X04 devices contain internal Flash program memory for storing and executing application code. The memory is readable, writable and erasable during normal operation over the entire VDD range.

Flash memory can be programmed in two ways:

- In-Circuit Serial Programming™ (ICSP™) programming capability
- Run-Time Self-Programming (RTSP)

ICSP allows the PIC24HJ32GP302/304, PIC24HJ64GPX02/X04 and PIC24HJ128GPX02/X04 devices to be serially programmed while in the end application circuit. This is done with two lines for programming clock and programming data (one of the alternate programming pin pairs: PGEC1/PGED1,

PGEC2/PGED2 or PGEC3/PGED3), and three other lines for power (VDD), ground (VSS) and Master Clear (MCLR). This allows customers to manufacture boards with unprogrammed devices and then program the microcontroller just before shipping the product. This also allows the most recent firmware or a custom firmware to be programmed.

RTSP is accomplished using TBLRD (table read) and TBLWT (table write) instructions. With RTSP, the user application can write program memory data either in blocks or ‘rows’ of 64 instructions (192 bytes) at a time or a single program memory word, and erase program memory in blocks or ‘pages’ of 512 instructions (1536 bytes) at a time.

5.1 Table Instructions and Flash Programming

Regardless of the method used, all programming of Flash memory is done with the table read and table write instructions. These allow direct read and write access to the program memory space from the data memory while the device is in normal operating mode. The 24-bit target address in the program memory is formed using bits <7:0> of the TBLPAG register and the Effective Address (EA) from a W register specified in the table instruction, as shown in [Figure 5-1](#).

The TBLRDL and the TBLWTL instructions are used to read or write to bits <15:0> of program memory. TBLRDL and TBLWTL can access program memory in both Word and Byte modes.

The TBLRDH and TBLWTH instructions are used to read or write to bits <23:16> of program memory. TBLRDH and TBLWTH can also access program memory in Word or Byte mode.

FIGURE 5-1: ADDRESSING FOR TABLE REGISTERS



5.2 RTSP Operation

The PIC24HJ32GP302/304, PIC24HJ64GPX02/X04 and PIC24HJ128GPX02/X04 Flash program memory array is organized into rows of 64 instructions or 192 bytes. RTSP allows the user application to erase a page of memory, which consists of eight rows (512 instructions) at a time, and to program one row or one word at a time. [Table 28-12](#) shows typical erase and programming times. The 8-row erase pages and single row write rows are edge-aligned from the beginning of program memory, on boundaries of 1536 bytes and 192 bytes, respectively.

The program memory implements holding buffers that can contain 64 instructions of programming data. Prior to the actual programming operation, the write data must be loaded into the buffers sequentially. The instruction words loaded must always be from a group of 64 boundary.

The basic sequence for RTSP programming is to set up a Table Pointer, then do a series of `TBLWTL` instructions to load the buffers. Programming is performed by setting the control bits in the NVMCON register. A total of 64 `TBLWTL` and `TBLWTH` instructions are required to load the instructions.

All of the table write operations are single-word writes (two instruction cycles) because only the buffers are written. A programming cycle is required for programming each row.

5.3 Programming Operations

A complete programming sequence is necessary for programming or erasing the internal Flash in RTSP mode. The processor stalls (waits) until the programming operation is finished.

The programming time depends on the FRC accuracy (see [Table 28-19](#)) and the value of the FRC Oscillator Tuning register (see [Register 9-4](#)). Use the following formula to calculate the minimum and maximum values for the Row Write Time, Page Erase Time, and Word Write Cycle Time parameters (see [Table 28-12](#)).

EQUATION 5-1: PROGRAMMING TIME

$$T = \frac{11064 \text{ Cycles}}{7.37 \text{ MHz} \times (\text{FRC Accuracy})\% \times (\text{FRC Tuning})\%}$$

For example, if the device is operating at +125°C, the FRC accuracy will be ±5%. If the `TUN<5:0>` bits (see [Register 9-4](#)) are set to `'b111111`, the minimum row write time is equal to [Equation 5-2](#).

EQUATION 5-2: MINIMUM ROW WRITE TIME

$$T_{RW} = \frac{11064 \text{ Cycles}}{7.37 \text{ MHz} \times (1 + 0.05) \times (1 - 0.00375)} = 1.435 \text{ ms}$$

The maximum row write time is equal to [Equation 5-3](#).

EQUATION 5-3: MAXIMUM ROW WRITE TIME

$$T_{RW} = \frac{11064 \text{ Cycles}}{7.37 \text{ MHz} \times (1 - 0.05) \times (1 - 0.00375)} = 1.586 \text{ ms}$$

Setting the WR bit (`NVMCON<15>`) starts the operation, and the WR bit is automatically cleared when the operation is finished.

5.4 Control Registers

Two SFRs are used to read and write the program Flash memory: NVMCON and NVMKEY.

The NVMCON register ([Register 5-1](#)) controls which blocks are to be erased, which memory type is to be programmed and the start of the programming cycle.

NVMKEY ([Register 5-2](#)) is a write-only register that is used for write protection. To start a programming or erase sequence, the user application must consecutively write 0x55 and 0xAA to the NVMKEY register. Refer to [Section 5.3 "Programming Operations"](#) for further details.

5.5 Flash Programming Resources

Many useful resources related to Flash Programming are provided on the main product page of the Microchip web site for the devices listed in this data sheet. This product page, which can be accessed using this [link](#), contains the latest updates and additional information.

Note: In the event you are not able to access the product page using the link above, enter this URL in your browser:
<http://www.microchip.com/wwwproducts/Devices.aspx?dDocName=en534555>

5.5.1 KEY RESOURCES

- **Section 5. "Flash Programming"** (DS70191)
- Code Samples
- Application Notes
- Software Libraries
- Webinars
- All related dsPIC33F/PIC24H Family Reference Manuals Sections
- Development Tools

5.6 Flash Memory Control Registers

REGISTER 5-1: NVMCON: FLASH MEMORY CONTROL REGISTER

R/SO-0 ⁽¹⁾	R/W-0 ⁽¹⁾	R/W-0 ⁽¹⁾	U-0	U-0	U-0	U-0	U-0
WR	WREN	WRERR	—	—	—	—	—
bit 15							bit 8
U-0	R/W-0 ⁽¹⁾	U-0	U-0	R/W-0 ⁽¹⁾	R/W-0 ⁽¹⁾	R/W-0 ⁽¹⁾	R/W-0 ⁽¹⁾
—	ERASE	—	—	NVMOP<3:0> ⁽²⁾			—
bit 7							bit 0

Legend:	SO = Settable only bit
R = Readable bit	W = Writable bit
-n = Value at POR	'1' = Bit is set
	U = Unimplemented bit, read as '0'
	'0' = Bit is cleared
	x = Bit is unknown

- bit 15 **WR:** Write Control bit
 1 = Initiates a Flash memory program or erase operation. The operation is self-timed and the bit is cleared by hardware once operation is complete
 0 = Program or erase operation is complete and inactive
- bit 14 **WREN:** Write Enable bit
 1 = Enable Flash program/erase operations
 0 = Inhibit Flash program/erase operations
- bit 13 **WRERR:** Write Sequence Error Flag bit
 1 = An improper program or erase sequence attempt or termination has occurred (bit is set automatically on any set attempt of the WR bit)
 0 = The program or erase operation completed normally
- bit 12-7 **Unimplemented:** Read as '0'
- bit 6 **ERASE:** Erase/Program Enable bit
 1 = Perform the erase operation specified by NVMOP<3:0> on the next WR command
 0 = Perform the program operation specified by NVMOP<3:0> on the next WR command
- bit 5-4 **Unimplemented:** Read as '0'
- bit 3-0 **NVMOP<3:0>:** NVM Operation Select bits⁽²⁾
If ERASE = 1:
 1111 = Memory bulk erase operation
 1110 = Reserved
 1101 = Erase General Segment
 1100 = Erase Secure Segment
 1011 = Reserved
 0011 = No operation
 0010 = Memory page erase operation
 0001 = No operation
 0000 = Erase a single Configuration register byte
- If ERASE = 0:
 1111 = No operation
 1110 = Reserved
 1101 = No operation
 1100 = No operation
 1011 = Reserved
 0011 = Memory word program operation
 0010 = No operation
 0001 = Memory row program operation
 0000 = Program a single Configuration register byte

Note 1: These bits can only be reset on a POR.

2: All other combinations of NVMOP<3:0> are unimplemented.

PIC24HJ32GP302/304, PIC24HJ64GPX02/X04 AND PIC24HJ128GPX02/X04

REGISTER 5-2: NVMKEY: NONVOLATILE MEMORY KEY REGISTER

U-0	U-0	U-0	U-0	U-0	U-0	U-0	U-0
—	—	—	—	—	—	—	—
bit 15							bit 8

W-0	W-0	W-0	W-0	W-0	W-0	W-0	W-0
NVMKEY<7:0>							
bit 7							bit 0

Legend:

R = Readable bit

W = Writable bit

U = Unimplemented bit, read as '0'

-n = Value at POR

'1' = Bit is set

'0' = Bit is cleared

x = Bit is unknown

bit 15-8

Unimplemented: Read as '0'

bit 7-0

NVMKEY<7:0>: Key Register (write-only) bits

5.6.1 PROGRAMMING ALGORITHM FOR FLASH PROGRAM MEMORY

Programmers can program one row of program Flash memory at a time. To do this, it is necessary to erase the 8-row erase page that contains the desired row. The general process is:

1. Read eight rows of program memory (512 instructions) and store in data RAM.
2. Update the program data in RAM with the desired new data.
3. Erase the block (see [Example 5-1](#)):
 - a) Set the NVMOP bits (NVMCON<3:0>) to '0010' to configure for block erase. Set the ERASE (NVMCON<6>) and WREN (NVMCON<14>) bits.
 - b) Write the starting address of the page to be erased into the TBLPAG and W registers.
 - c) Write 0x55 to NVMKEY.
 - d) Write 0xAA to NVMKEY.
 - e) Set the WR bit (NVMCON<15>). The erase cycle begins and the CPU stalls for the duration of the erase cycle. When the erase is done, the WR bit is cleared automatically.

4. Write the first 64 instructions from data RAM into the program memory buffers (see [Example 5-2](#)).
5. Write the program block to Flash memory:
 - a) Set the NVMOP bits to '0001' to configure for row programming. Clear the ERASE bit and set the WREN bit.
 - b) Write 0x55 to NVMKEY.
 - c) Write 0xAA to NVMKEY.
 - d) Set the WR bit. The programming cycle begins and the CPU stalls for the duration of the write cycle. When the write to Flash memory is done, the WR bit is cleared automatically.
6. Repeat steps 4 and 5, using the next available 64 instructions from the block in data RAM by incrementing the value in TBLPAG, until all 512 instructions are written back to Flash memory.

For protection against accidental operations, the write initiate sequence for NVMKEY must be used to allow any erase or program operation to proceed. After the programming command has been executed, the user application must wait for the programming time until programming is complete. The two instructions following the start of the programming sequence should be NOPs, as shown in [Example 5-3](#).

EXAMPLE 5-1: ERASING A PROGRAM MEMORY PAGE

```

; Set up NVMCON for block erase operation
MOV    #0x4042, W0           ;
MOV    W0, NVMCON           ; Initialize NVMCON
; Init pointer to row to be ERASED
MOV    #tblpage(PROG_ADDR), W0 ;
MOV    W0, TBLPAG           ; Initialize PM Page Boundary SFR
MOV    #tbloffset(PROG_ADDR), W0 ; Initialize in-page EA[15:0] pointer
TBLWTL W0, [W0]             ; Set base address of erase block
DISI   #5                   ; Block all interrupts with priority <7
                                           ; for next 5 instructions

MOV    #0x55, W0
MOV    W0, NVMKEY           ; Write the 55 key
MOV    #0xAA, W1
MOV    W1, NVMKEY           ; Write the AA key
BSET   NVMCON, #WR         ; Start the erase sequence
NOP                                         ; Insert two NOPs after the erase
NOP                                         ; command is asserted
    
```

EXAMPLE 5-2: LOADING THE WRITE BUFFERS

```
; Set up NVMCON for row programming operations
MOV    #0x4001, W0          ;
MOV    W0, NVMCON          ; Initialize NVMCON
; Set up a pointer to the first program memory location to be written
; program memory selected, and writes enabled
MOV    #0x0000, W0          ;
MOV    W0, TBLPAG          ; Initialize PM Page Boundary SFR
MOV    #0x6000, W0          ; An example program memory address
; Perform the TBLWT instructions to write the latches
; 0th_program_word
MOV    #LOW_WORD_0, W2      ;
MOV    #HIGH_BYTE_0, W3     ;
TBLWTL W2, [W0]            ; Write PM low word into program latch
TBLWTH W3, [W0++]          ; Write PM high byte into program latch
; 1st_program_word
MOV    #LOW_WORD_1, W2      ;
MOV    #HIGH_BYTE_1, W3     ;
TBLWTL W2, [W0]            ; Write PM low word into program latch
TBLWTH W3, [W0++]          ; Write PM high byte into program latch
; 2nd_program_word
MOV    #LOW_WORD_2, W2      ;
MOV    #HIGH_BYTE_2, W3     ;
TBLWTL W2, [W0]            ; Write PM low word into program latch
TBLWTH W3, [W0++]          ; Write PM high byte into program latch
.
.
.
; 63rd_program_word
MOV    #LOW_WORD_31, W2     ;
MOV    #HIGH_BYTE_31, W3    ;
TBLWTL W2, [W0]            ; Write PM low word into program latch
TBLWTH W3, [W0++]          ; Write PM high byte into program latch
```

EXAMPLE 5-3: INITIATING A PROGRAMMING SEQUENCE

```
DISI   #5                  ; Block all interrupts with priority <7
                                ; for next 5 instructions
MOV    #0x55, W0           ; Write the 55 key
MOV    W0, NVMKEY          ;
MOV    #0xAA, W1           ;
MOV    W1, NVMKEY          ; Write the AA key
BSET   NVMCON, #WR         ; Start the erase sequence
NOP    ; Insert two NOPs after the
NOP    ; erase command is asserted
```

6.0 RESETS

Note 1: This data sheet summarizes the features of the PIC24HJ32GP302/304, PIC24HJ64GPX02/X04 and PIC24HJ128GPX02/X04 families of devices. It is not intended to be a comprehensive reference source. To complement the information in this data sheet, refer to **Section 8. “Reset”** (DS70192) of the “*dsPIC33F/PIC24H Family Reference Manual*”, which is available from the Microchip web site (www.microchip.com).

2: Some registers and associated bits described in this section may not be available on all devices. Refer to **Section 4.0 “Memory Organization”** in this data sheet for device-specific register and bit information.

The Reset module combines all reset sources and controls the device Master Reset Signal, $\overline{\text{SYSRST}}$. The following is a list of device Reset sources:

- POR: Power-on Reset
- BOR: Brown-out Reset
- $\overline{\text{MCLR}}$: Master Clear Pin Reset
- SWR: $\overline{\text{RESET}}$ Instruction
- WDTO: Watchdog Timer Reset
- CM: Configuration Mismatch Reset
- TRAPR: Trap Conflict Reset
- IOPUWR: Illegal Condition Device Reset
 - Illegal Opcode Reset
 - Uninitialized W Register Reset
 - Security Reset

A simplified block diagram of the Reset module is shown in **Figure 6-1**.

Any active source of reset will make the $\overline{\text{SYSRST}}$ signal active. On system Reset, some of the registers associated with the CPU and peripherals are forced to a known Reset state and some are unaffected.

Note: Refer to the specific peripheral section or **Section 3.0 “CPU”** of this manual for register Reset states.

All types of device Reset sets a corresponding status bit in the RCON register to indicate the type of Reset (see **Register 6-1**).

A POR clears all the bits, except for the POR bit ($\text{RCON}<0>$), that are set. The user application can set or clear any bit at any time during code execution. The RCON bits only serve as status bits. Setting a particular Reset status bit in software does not cause a device Reset to occur.

The RCON register also has other bits associated with the Watchdog Timer and device power-saving states. The function of these bits is discussed in other sections of this manual.

Note: The status bits in the RCON register should be cleared after they are read so that the next RCON register value after a device Reset is meaningful.

FIGURE 6-1: RESET SYSTEM BLOCK DIAGRAM



6.1 Reset Resources

Many useful resources related to Resets are provided on the main product page of the Microchip web site for the devices listed in this data sheet. This product page, which can be accessed using this [link](#), contains the latest updates and additional information.

<p>Note: In the event you are not able to access the product page using the link above, enter this URL in your browser: http://www.microchip.com/wwwproducts/Devices.aspx?dDocName=en534555</p>
--

6.1.1 KEY RESOURCES

- **Section 8. “Resets”** (DS70192)
- Code Samples
- Application Notes
- Software Libraries
- Webinars
- All related dsPIC33F/PIC24H Family Reference Manuals Sections
- Development Tools

6.2 Reset Control Registers

REGISTER 6-1: RCON: RESET CONTROL REGISTER⁽¹⁾

R/W-0	R/W-0	U-0	U-0	U-0	U-0	R/W-0	R/W-0
TRAPR	IOPUWR	—	—	—	—	CM	VREGS
bit 15						bit 8	

R/W-0	R/W-0	R/W-0	R/W-0	R/W-0	R/W-0	R/W-1	R/W-1
EXTR	SWR	SWDTEN ⁽²⁾	WDTO	SLEEP	IDLE	BOR	POR
bit 7						bit 0	

Legend:

R = Readable bit W = Writable bit U = Unimplemented bit, read as '0'
 -n = Value at POR '1' = Bit is set '0' = Bit is cleared x = Bit is unknown

- bit 15 **TRAPR:** Trap Reset Flag bit
 1 = A Trap Conflict Reset has occurred
 0 = A Trap Conflict Reset has not occurred
- bit 14 **IOPUWR:** Illegal Opcode or Uninitialized W Access Reset Flag bit
 1 = An illegal opcode detection, an illegal address mode or uninitialized W register used as an Address Pointer caused a Reset
 0 = An illegal opcode or uninitialized W Reset has not occurred
- bit 13-10 **Unimplemented:** Read as '0'
- bit 9 **CM:** Configuration Mismatch Flag bit
 1 = A configuration mismatch Reset has occurred.
 0 = A configuration mismatch Reset has NOT occurred
- bit 8 **VREGS:** Voltage Regulator Standby During Sleep bit
 1 = Voltage regulator is active during Sleep
 0 = Voltage regulator goes into Standby mode during Sleep
- bit 7 **EXTR:** External Reset ($\overline{\text{MCLR}}$) Pin bit
 1 = A Master Clear (pin) Reset has occurred
 0 = A Master Clear (pin) Reset has not occurred
- bit 6 **SWR:** Software Reset (Instruction) Flag bit
 1 = A RESET instruction has been executed
 0 = A RESET instruction has not been executed
- bit 5 **SWDTEN:** Software Enable/Disable of WDT bit⁽²⁾
 1 = WDT is enabled
 0 = WDT is disabled
- bit 4 **WDTO:** Watchdog Timer Time-out Flag bit
 1 = WDT time-out has occurred
 0 = WDT time-out has not occurred
- bit 3 **SLEEP:** Wake-up from Sleep Flag bit
 1 = Device has been in Sleep mode
 0 = Device has not been in Sleep mode
- bit 2 **IDLE:** Wake-up from Idle Flag bit
 1 = Device was in Idle mode
 0 = Device was not in Idle mode

Note 1: All of the Reset status bits can be set or cleared in software. Setting one of these bits in software does not cause a device Reset.

2: If the SWDTEN Configuration bit is '1' (unprogrammed), the WDT is always enabled, regardless of the SWDTEN bit setting.

REGISTER 6-1: RCON: RESET CONTROL REGISTER⁽¹⁾ (CONTINUED)

- bit 1 **BOR:** Brown-out Reset Flag bit
 1 = A Brown-out Reset has occurred
 0 = A Brown-out Reset has not occurred

- bit 0 **POR:** Power-on Reset Flag bit
 1 = A Power-on Reset has occurred
 0 = A Power-on Reset has not occurred

- Note 1:** All of the Reset status bits can be set or cleared in software. Setting one of these bits in software does not cause a device Reset.
- 2:** If the FWDTEN Configuration bit is '1' (unprogrammed), the WDT is always enabled, regardless of the SWDTEN bit setting.

6.3 System Reset

The PIC24HJ32GP302/304, PIC24HJ64GPX02/X04 and PIC24HJ128GPX02/X04 family of devices have two types of Reset:

- Cold Reset
- Warm Reset

A cold Reset is the result of a Power-on Reset (POR) or a Brown-out Reset (BOR). On a cold Reset, the FNOSC configuration bits in the FOSC device configuration register selects the device clock source.

A warm Reset is the result of all other reset sources, including the RESET instruction. On warm Reset, the device will continue to operate from the current clock source as indicated by the Current Oscillator Selection bits (COSC<2:0>) in the Oscillator Control register (OSCCON<14:12>).

The device is kept in a Reset state until the system power supplies have stabilized at appropriate levels and the oscillator clock is ready. A description of the sequence in which this occurs and is shown in [Figure 6-2](#).

TABLE 6-1: OSCILLATOR DELAY

Oscillator Mode	Oscillator Startup Delay	Oscillator Startup Timer	PLL Lock Time	Total Delay
FRC, FRCDIV16, FRCDIVN	TOSCD	—	—	TOSCD
FRCPLL	TOSCD	—	TLOCK	TOSCD + TLOCK
XT	TOSCD	TOST	—	TOSCD + TOST
HS	TOSCD	TOST	—	TOSCD + TOST
EC	—	—	—	—
XTPLL	TOSCD	TOST	TLOCK	TOSCD + TOST + TLOCK
HSPLL	TOSCD	TOST	TLOCK	TOSCD + TOST + TLOCK
ECPLL	—	—	TLOCK	TLOCK
Sosc	TOSCD	TOST	—	TOSCD + TOST
LPRC	TOSCD	—	—	TOSCD

- Note 1:** TOSCD = Oscillator Start-up Delay (1.1 μs max for FRC, 70 μs max for LPRC). Crystal Oscillator start-up times vary with crystal characteristics, load capacitance, etc.
- 2:** TOST = Oscillator Start-up Timer Delay (1024 oscillator clock period). For example, TOST = 102.4 μs for a 10 MHz crystal and TOST = 32 ms for a 32 kHz crystal.
- 3:** TLOCK = PLL lock time (1.5 ms nominal), if PLL is enabled.

FIGURE 6-2: SYSTEM RESET TIMING



TABLE 6-2: OSCILLATOR DELAY

Symbol	Parameter	Value
VPOR	POR threshold	1.8V nominal
TPOR	POR extension time	30 μ s maximum
VBOR	BOR threshold	2.5V nominal
TBOR	BOR extension time	100 μ s maximum
TPWRT	Programmable power-up time delay	0-128 ms nominal
TFSCM	Fail-Safe Clock Monitor Delay	900 μ s maximum

Note: When the device exits the Reset condition (begins normal operation), the device operating parameters (voltage, frequency, temperature, etc.) must be within their operating ranges, otherwise the device may not function correctly. The user application must ensure that the delay between the time power is first applied, and the time SYSRST becomes inactive, is long enough to get all operating parameters within specification.

6.4 Power-on Reset (POR)

A Power-on Reset (POR) circuit ensures the device is reset from power-on. The POR circuit is active until VDD crosses the VPOR threshold and the delay TPOR has elapsed. The delay TPOR ensures the internal device bias circuits become stable.

The device supply voltage characteristics must meet the specified starting voltage and rise rate requirements to generate the POR. Refer to [Section 28.0 “Electrical Characteristics”](#) for details.

The POR status bit (POR) in the Reset Control register (RCON<0>) is set to indicate the Power-on Reset.

6.4.1 Brown-out Reset (BOR) and Power-up timer (PWRT)

The on-chip regulator has a Brown-out Reset (BOR) circuit that resets the device when the VDD is too low ($V_{DD} < V_{BOR}$) for proper device operation. The BOR circuit keeps the device in Reset until VDD crosses VBOR threshold and the delay TBOR has elapsed. The delay TBOR ensures the voltage regulator output becomes stable.

The Brown-out Reset status bit (BOR) in the Reset Control register (RCON<1>) is set to indicate the BOR.

The device will not run at full speed after a BOR as the VDD should rise to acceptable levels for full-speed operation. The PWRT provides power-up time delay (TPWRT) to ensure that the system power supplies have stabilized at the appropriate levels for full-speed operation before the SYSRST is released.

The power-up timer delay (TPWRT) is programmed by the Power-on Reset Timer Value Select bits (FPWRT<2:0>) in the POR Configuration register (FPOR<2:0>), which provides eight settings (from 0 ms to 128 ms). Refer to [Section 25.0 “Special Features”](#) for further details.

[Figure 6-3](#) shows the typical brown-out scenarios. The reset delay (TBOR + TPWRT) is initiated each time VDD rises above the VBOR trip point

FIGURE 6-3: BROWN-OUT SITUATIONS



6.5 External Reset (EXTR)

The external Reset is generated by driving the $\overline{\text{MCLR}}$ pin low. The $\overline{\text{MCLR}}$ pin is a Schmitt trigger input with an additional glitch filter. Reset pulses that are longer than the minimum pulse width will generate a Reset. Refer to [Section 28.0 “Electrical Characteristics”](#) for minimum pulse width specifications. The External Reset ($\overline{\text{MCLR}}$) Pin (EXTR) bit in the Reset Control (RCON) register is set to indicate the $\overline{\text{MCLR}}$ Reset.

6.5.1 EXTERNAL SUPERVISORY CIRCUIT

Many systems have external supervisory circuits that generate reset signals to reset multiple devices in the system. This external Reset signal can be directly connected to the $\overline{\text{MCLR}}$ pin to reset the device when the rest of system is Reset.

6.5.2 INTERNAL SUPERVISORY CIRCUIT

When using the internal power supervisory circuit to reset the device, the external reset pin ($\overline{\text{MCLR}}$) should be tied directly or resistively to VDD. In this case, the $\overline{\text{MCLR}}$ pin will not be used to generate a Reset. The external reset pin ($\overline{\text{MCLR}}$) does not have an internal pull-up and must not be left unconnected.

6.6 Software RESET Instruction (SWR)

Whenever the `RESET` instruction is executed, the device will assert $\overline{\text{SYSRST}}$, placing the device in a special Reset state. This Reset state will not re-initialize the clock. The clock source in effect prior to the `RESET` instruction will remain. $\overline{\text{SYSRST}}$ is released at the next instruction cycle, and the reset vector fetch will commence.

The Software Reset (Instruction) Flag bit (SWR) in the Reset Control register (RCON<6>) is set to indicate the software Reset.

6.7 Watchdog Time-out Reset (WDTO)

Whenever a Watchdog time-out occurs, the device will asynchronously assert $\overline{\text{SYSRST}}$. The clock source will remain unchanged. A WDT time-out during Sleep or Idle mode will wake-up the processor, but will not reset the processor.

The Watchdog Timer Time-out Flag bit (WDTO) in the Reset Control register (RCON<4>) is set to indicate the Watchdog Reset. Refer to [Section 25.4 “Watchdog Timer \(WDT\)”](#) for more information on Watchdog Reset.

6.8 Trap Conflict Reset

If a lower-priority hard trap occurs while a higher-priority trap is being processed, a hard trap conflict Reset occurs. The hard traps include exceptions of priority level 13 through level 15, inclusive. The address error (level 13) and oscillator error (level 14) traps fall into this category.

The Trap Reset Flag bit (TRAPR) in the Reset Control register (RCON<15>) is set to indicate the Trap Conflict Reset. Refer to [Section 7.0 “Interrupt Controller”](#) for more information on trap conflict Resets.

6.9 Configuration Mismatch Reset

To maintain the integrity of the peripheral pin select control registers, they are constantly monitored with shadow registers in hardware. If an unexpected change in any of the registers occur (such as cell disturbances caused by ESD or other external events), a configuration mismatch Reset occurs.

The Configuration Mismatch Flag bit (CM) in the Reset Control register (RCON<9>) is set to indicate the configuration mismatch Reset. Refer to [Section 11.0 “I/O Ports”](#) for more information on the configuration mismatch Reset.

Note: The configuration mismatch feature and associated reset flag is not available on all devices.

6.10 Illegal Condition Device Reset

An illegal condition device Reset occurs due to the following sources:

- Illegal Opcode Reset
- Uninitialized W Register Reset
- Security Reset

The Illegal Opcode or Uninitialized W Access Reset Flag bit (IOPUWR) in the Reset Control register (RCON<14>) is set to indicate the illegal condition device Reset.

6.10.1 ILLEGAL OPCODE RESET

A device Reset is generated if the device attempts to execute an illegal opcode value that is fetched from program memory.

The illegal opcode Reset function can prevent the device from executing program memory sections that are used to store constant data. To take advantage of the illegal opcode Reset, use only the lower 16 bits of

each program memory section to store the data values. The upper 8 bits should be programmed with 3Fh, which is an illegal opcode value.

6.10.2 UNINITIALIZED W REGISTER RESET

Any attempts to use the uninitialized W register as an address pointer will Reset the device. The W register array (with the exception of W15) is cleared during all resets and is considered uninitialized until written to.

6.10.3 SECURITY RESET

If a Program Flow Change (PFC) or Vector Flow Change (VFC) targets a restricted location in a protected segment (Boot and Secure Segment), that operation will cause a security Reset.

The PFC occurs when the Program Counter is reloaded as a result of a Call, Jump, Computed Jump, Return, Return from Subroutine, or other form of branch instruction.

The VFC occurs when the Program Counter is reloaded with an Interrupt or Trap vector.

Refer to [Section 25.8 “Code Protection and CodeGuard™ Security”](#) for more information on Security Reset.

6.11 Using the RCON Status Bits

The user application can read the Reset Control register (RCON) after any device Reset to determine the cause of the reset.

Note: The status bits in the RCON register should be cleared after they are read so that the next RCON register value after a device Reset will be meaningful.

[Table 6-3](#) provides a summary of the reset flag bit operation.

TABLE 6-3: RESET FLAG BIT OPERATION

Flag Bit	Set by:	Cleared by:
TRAPR (RCON<15>)	Trap conflict event	POR, BOR
IOPWR (RCON<14>)	Illegal opcode or uninitialized W register access or Security Reset	POR, BOR
CM (RCON<9>)	Configuration Mismatch	POR, BOR
EXTR (RCON<7>)	MCLR Reset	POR
SWR (RCON<6>)	RESET instruction	POR, BOR
WDTO (RCON<4>)	WDT time-out	PWRSV instruction, CLRWDT instruction, POR, BOR
SLEEP (RCON<3>)	PWRSV #SLEEP instruction	POR, BOR
IDLE (RCON<2>)	PWRSV #IDLE instruction	POR, BOR
BOR (RCON<1>)	POR, BOR	—
POR (RCON<0>)	POR	—

Note: All Reset flag bits can be set or cleared by user software.

NOTES:

7.0 INTERRUPT CONTROLLER

Note 1: This data sheet summarizes the features of the PIC24HJ32GP302/304, PIC24HJ64GPX02/X04 and PIC24HJ128GPX02/X04 families of devices. It is not intended to be a comprehensive reference source. To complement the information in this data sheet, refer to **Section 32. “Interrupts (Part III)”** (DS70214) of the “*dsPIC33F/PIC24H Family Reference Manual*”, which is available from the Microchip web site (www.microchip.com).

2: Some registers and associated bits described in this section may not be available on all devices. Refer to **Section 4.0 “Memory Organization”** in this data sheet for device-specific register and bit information.

The PIC24HJ32GP302/304, PIC24HJ64GPX02/X04 and PIC24HJ128GPX02/X04 interrupt controller reduces the numerous peripheral interrupt request signals to a single interrupt request signal to the PIC24HJ32GP302/304, PIC24HJ64GPX02/X04 and PIC24HJ128GPX02/X04 CPU.

The interrupt controller has the following features:

- Up to eight processor exceptions and software traps
- Eight user-selectable priority levels
- Interrupt Vector Table (IVT) with up to 118 vectors
- A unique vector for each interrupt or exception source
- Fixed priority within a specified user priority level
- Alternate Interrupt Vector Table (AIVT) for debug support
- Fixed interrupt entry and return latencies

7.1 Interrupt Vector Table

The Interrupt Vector Table (IVT), shown in [Figure 7-1](#), resides in program memory, starting at location 000004h. The IVT contains 126 vectors consisting of eight nonmaskable trap vectors plus up to 118 sources of interrupt. In general, each interrupt source has its own vector. Each interrupt vector contains a 24 bit wide address. The value programmed into each interrupt vector location is the starting address of the associated Interrupt Service Routine (ISR).

Interrupt vectors are prioritized in terms of their natural priority. This priority is linked to their position in the vector table. Lower addresses generally have a higher natural priority. For example, the interrupt associated with vector 0 takes priority over interrupts at any other vector address.

PIC24HJ32GP302/304, PIC24HJ64GPX02/X04 and PIC24HJ128GPX02/X04 devices implement up to 45 unique interrupts and five nonmaskable traps. These are summarized in [Table 7-1](#).

7.1.1 ALTERNATE INTERRUPT VECTOR TABLE

The Alternate Interrupt Vector Table (AIVT) is located after the IVT, as shown in [Figure 7-1](#). Access to the AIVT is provided by the ALTIVT control bit (INTCON2<15>). If the ALTIVT bit is set, all interrupt and exception processes use the alternate vectors instead of the default vectors. The alternate vectors are organized in the same manner as the default vectors.

The AIVT supports debugging by providing a means to switch between an application and a support environment without requiring the interrupt vectors to be reprogrammed. This feature also enables switching between applications for evaluation of different software algorithms at run time. If the AIVT is not needed, the AIVT should be programmed with the same addresses used in the IVT.

7.2 Reset Sequence

A device Reset is not a true exception because the interrupt controller is not involved in the Reset process. The PIC24HJ32GP302/304, PIC24HJ64GPX02/X04 and PIC24HJ128GPX02/X04 device clears its registers in response to a Reset, which forces the PC to zero. The microcontroller then begins program execution at location 0x000000. A GOTO instruction at the Reset address can redirect program execution to the appropriate start-up routine.

Note: Any unimplemented or unused vector locations in the IVT and AIVT should be programmed with the address of a default interrupt handler routine that contains a RESET instruction.

FIGURE 7-1: PIC24HJ32GP302/304, PIC24HJ64GPX02/X04 and PIC24HJ128GPX02/X04 INTERRUPT VECTOR TABLE



Note 1: See Table 7-1 for the list of implemented interrupt vectors.

TABLE 7-1: INTERRUPT VECTORS

Vector Number	IVT Address	AIVT Address	Interrupt Source
0	0x000004	0x000104	Reserved
1	0x000006	0x000106	Oscillator Failure
2	0x000008	0x000108	Address Error
3	0x00000A	0x00010A	Stack Error
4	0x00000C	0x00010C	Math Error
5	0x00000E	0x00010E	DMA Error
6-7	0x000010-0x000012	0x000110-0x000112	Reserved
8	0x000014	0x000114	INT0 – External Interrupt 0
9	0x000016	0x000116	IC1 – Input Capture 1
10	0x000018	0x000118	OC1 – Output Compare 1
11	0x00001A	0x00011A	T1 – Timer1
12	0x00001C	0x00011C	DMA0 – DMA Channel 0
13	0x00001E	0x00011E	IC2 – Input Capture 2
14	0x000020	0x000120	OC2 – Output Compare 2
15	0x000022	0x000122	T2 – Timer2
16	0x000024	0x000124	T3 – Timer3
17	0x000026	0x000126	SPI1E – SPI1 Error
18	0x000028	0x000128	SPI1 – SPI1 Transfer Done
19	0x00002A	0x00012A	U1RX – UART1 Receiver
20	0x00002C	0x00012C	U1TX – UART1 Transmitter
21	0x00002E	0x00012E	ADC1 – ADC 1
22	0x000030	0x000130	DMA1 – DMA Channel 1
23	0x000032	0x000132	Reserved
24	0x000034	0x000134	SI2C1 – I2C1 Slave Events
25	0x000036	0x000136	MI2C1 – I2C1 Master Events
26	0x000038	0x000138	CM – Comparator Interrupt
27	0x00003A	0x00013A	CN – Change Notification Interrupt
28	0x00003C	0x00013C	INT1 – External Interrupt 1
29	0x00003E	0x00013E	Reserved
30	0x000040	0x000140	IC7 – Input Capture 7
31	0x000042	0x000142	IC8 – Input Capture 8
32	0x000044	0x000144	DMA2 – DMA Channel 2
33	0x000046	0x000146	OC3 – Output Compare 3
34	0x000048	0x000148	OC4 – Output Compare 4
35	0x00004A	0x00014A	T4 – Timer4
36	0x00004C	0x00014C	T5 – Timer5
37	0x00004E	0x00014E	INT2 – External Interrupt 2
38	0x000050	0x000150	U2RX – UART2 Receiver
39	0x000052	0x000152	U2TX – UART2 Transmitter
40	0x000054	0x000154	SPI2E – SPI2 Error
41	0x000056	0x000156	SPI2 – SPI2 Transfer Done
42	0x000058	0x000158	C1RX – ECAN1 RX Data Ready
43	0x00005A	0x00015A	C1 – ECAN1 Event
44	0x00005C	0x00015C	DMA3 – DMA Channel 3
45-52	0x00005E-0x00006C	0x00015E-0x00016C	Reserved
53	0x00006E	0x00016E	PMP – Parallel Master Port
54	0x000070	0x000170	DMA – DMA Channel 4

TABLE 7-1: INTERRUPT VECTORS (CONTINUED)

Vector Number	IVT Address	AIVT Address	Interrupt Source
55-68	0x000072-0x00008C	0x000172-0x00018C	Reserved
69	0x00008E	0x00018E	DMA5 – DMA Channel 5
70	0x000090	0x000190	RTCC – Real Time Clock
71-72	0x000092-0x000094	0x000192-0x000194	Reserved
73	0x000096	0x000196	U1E – UART1 Error
74	0x000098	0x000198	U2E – UART2 Error
75	0x00009A	0x00019A	CRC – CRC Generator Interrupt
76	0x00009C	0x00019C	DMA6 – DMA Channel 6
77	0x00009E	0x00019E	DMA7 – DMA Channel 7
78	0x0000A0	0x0001A0	C1TX – ECAN1 TX Data Request
79-126	0x0000A2-0x0000FE	0x0001A2-0x0001FE	Reserved

7.3 Interrupt Control and Status Registers

PIC24HJ32GP302/304, PIC24HJ64GPX02/X04 and PIC24HJ128GPX02/X04 devices implement a total of 30 registers for the interrupt controller:

- INTCON1
- INTCON2
- IFSx
- IECx
- IPCx
- INTTREG

7.3.1 INTCON1 AND INTCON2

Global interrupt control functions are controlled from INTCON1 and INTCON2. INTCON1 contains the Interrupt Nesting Disable (NSTDIS) bit as well as the control and status flags for the processor trap sources. The INTCON2 register controls the external interrupt request signal behavior and the use of the Alternate Interrupt Vector Table.

7.3.2 IFSx

The IFS registers maintain all of the interrupt request flags. Each source of interrupt has a status bit, which is set by the respective peripherals or external signal and is cleared via software.

7.3.3 IECx

The IEC registers maintain all of the interrupt enable bits. These control bits are used to individually enable interrupts from the peripherals or external signals.

7.3.4 IPCx

The IPC registers are used to set the interrupt priority level for each source of interrupt. Each user interrupt source can be assigned to one of eight priority levels.

7.3.5 INTTREG

The INTTREG register contains the associated interrupt vector number and the new CPU interrupt priority level, which are latched into vector number (VECNUM<6:0>) and Interrupt level (ILR<3:0>) bit fields in the INTTREG register. The new interrupt priority level is the priority of the pending interrupt.

The interrupt sources are assigned to the IFSx, IECx and IPCx registers in the same sequence that they are listed in [Table 7-1](#). For example, the INT0 (External Interrupt 0) is shown as having vector number 8 and a natural order priority of 0. Thus, the INTOIF bit is found in IFS0<0>, the INTOIE bit in IEC0<0>, and the INTOIP bits in the first position of IPC0 (IPC0<2:0>).

7.3.6 STATUS/CONTROL REGISTERS

Although they are not specifically part of the interrupt control hardware, two of the CPU Control registers contain bits that control interrupt functionality.

- The CPU STATUS register, SR, contains the IPL<2:0> bits (SR<7:5>). These bits indicate the current CPU interrupt priority level. The user software can change the current CPU priority level by writing to the IPL bits.
- The CORCON register contains the IPL3 bit which, together with IPL<2:0>, also indicates the current CPU priority level. IPL3 is a read-only bit so that trap events cannot be masked by the user software.

All Interrupt registers are described in [Register 7-1](#) through [Register 7-29](#).

7.4 Interrupt Resources

Many useful resources related Interrupts are provided on the main product page of the Microchip web site for the devices listed in this data sheet. This product page, which can be accessed using this [link](#), contains the latest updates and additional information.

Note: In the event you are not able to access the product page using the link above, enter this URL in your browser:
<http://www.microchip.com/wwwproducts/Devices.aspx?dDoc-Name=en534555>

7.4.1 KEY RESOURCES

- **Section 32. “Interrupts (Part III)”** (DS70214)
- Code Samples
- Application Notes
- Software Libraries
- Webinars
- All related dsPIC33F/PIC24H Family Reference Manuals Sections
- Development Tools

7.5 Interrupt Control Registers

REGISTER 7-1: SR: CPU STATUS REGISTER⁽¹⁾

U-0	U-0	U-0	U-0	U-0	U-0	U-0	R/W-0
—	—	—	—	—	—	—	DC
bit 15							bit 8

R/W-0 ⁽³⁾	R/W-0 ⁽³⁾	R/W-0 ⁽³⁾	R-0	R/W-0	R/W-0	R/W-0	R/W-0
IPL<2:0> ⁽²⁾			RA	N	OV	Z	C
bit 7							bit 0

Legend:

C = Clear only bit	R = Readable bit	U = Unimplemented bit, read as '0'
S = Set only bit	W = Writable bit	-n = Value at POR
'1' = Bit is set	'0' = Bit is cleared	x = Bit is unknown

bit 7-5 **IPL<2:0>**: CPU Interrupt Priority Level Status bits⁽²⁾

111 = CPU Interrupt Priority Level is 7 (15), user interrupts disabled
 110 = CPU Interrupt Priority Level is 6 (14)
 101 = CPU Interrupt Priority Level is 5 (13)
 100 = CPU Interrupt Priority Level is 4 (12)
 011 = CPU Interrupt Priority Level is 3 (11)
 010 = CPU Interrupt Priority Level is 2 (10)
 001 = CPU Interrupt Priority Level is 1 (9)
 000 = CPU Interrupt Priority Level is 0 (8)

- Note 1:** For complete register details, see [Register 3-1](#).
- 2:** The IPL<2:0> bits are concatenated with the IPL<3> bit (CORCON<3>) to form the CPU Interrupt Priority Level. The value in parentheses indicates the IPL if IPL<3> = 1. User interrupts are disabled when IPL<3> = 1.
- 3:** The IPL<2:0> Status bits are read-only when the NSTDIS bit (INTCON1<15>) = 1.

REGISTER 7-2: CORCON: CORE CONTROL REGISTER⁽¹⁾

U-0	U-0	U-0	U-0	U-0	U-0	U-0	U-0
—	—	—	—	—	—	—	—
bit 15							bit 8

U-0	U-0	U-0	U-0	R/C-0	R/W-0	U-0	U-0
—	—	—	—	IPL3 ⁽²⁾	PSV	—	—
bit 7							bit 0

Legend:

C = Clear only bit	W = Writable bit	-n = Value at POR	'1' = Bit is set
R = Readable bit	'x' = Bit is unknown	U = Unimplemented bit, read as '0'	

bit 3 **IPL3**: CPU Interrupt Priority Level Status bit 3⁽²⁾

1 = CPU interrupt priority level is greater than 7
 0 = CPU interrupt priority level is 7 or less

- Note 1:** For complete register details, see [Register 3-2](#).
- 2:** The IPL3 bit is concatenated with the IPL<2:0> bits (SR<7:5>) to form the CPU Interrupt Priority Level.

REGISTER 7-3: INTCON1: INTERRUPT CONTROL REGISTER 1

R/W-0	U-0	U-0	U-0	U-0	U-0	U-0	U-0
NSTDIS	—	—	—	—	—	—	—
bit 15							bit 8

U-0	R/W-0	R/W-0	R/W-0	R/W-0	R/W-0	R/W-0	U-0
—	DIV0ERR	DMACERR	MATHERR	ADDRERR	STKERR	OSCFAIL	—
bit 7							bit 0

Legend:			
R = Readable bit	W = Writable bit	U = Unimplemented bit, read as '0'	
-n = Value at POR	'1' = Bit is set	'0' = Bit is cleared	x = Bit is unknown

- bit 15 **NSTDIS:** Interrupt Nesting Disable bit
 1 = Interrupt nesting is disabled
 0 = Interrupt nesting is enabled
- bit 14-7 **Unimplemented:** Read as '0'
- bit 6 **DIV0ERR:** Arithmetic Error Status bit
 1 = Math error trap was caused by a divide by zero
 0 = Math error trap was not caused by a divide by zero
- bit 5 **DMACERR:** DMA Controller Error Status bit
 1 = DMA controller error trap has occurred
 0 = DMA controller error trap has not occurred
- bit 4 **MATHERR:** Arithmetic Error Status bit
 1 = Math error trap has occurred
 0 = Math error trap has not occurred
- bit 3 **ADDRERR:** Address Error Trap Status bit
 1 = Address error trap has occurred
 0 = Address error trap has not occurred
- bit 2 **STKERR:** Stack Error Trap Status bit
 1 = Stack error trap has occurred
 0 = Stack error trap has not occurred
- bit 1 **OSCFAIL:** Oscillator Failure Trap Status bit
 1 = Oscillator failure trap has occurred
 0 = Oscillator failure trap has not occurred
- bit 0 **Unimplemented:** Read as '0'

PIC24HJ32GP302/304, PIC24HJ64GPX02/X04 AND PIC24HJ128GPX02/X04

REGISTER 7-4: INTCON2: INTERRUPT CONTROL REGISTER 2

R/W-0	R-0	U-0	U-0	U-0	U-0	U-0	U-0
ALTIVT	DISI	—	—	—	—	—	—
bit 15						bit 8	

U-0	U-0	U-0	U-0	U-0	R/W-0	R/W-0	R/W-0
—	—	—	—	—	INT2EP	INT1EP	INT0EP
bit 7					bit 0		

Legend:

R = Readable bit	W = Writable bit	U = Unimplemented bit, read as '0'
-n = Value at POR	'1' = Bit is set	'0' = Bit is cleared
		x = Bit is unknown

- bit 15 **ALTIVT:** Enable Alternate Interrupt Vector Table bit
 1 = Use alternate vector table
 0 = Use standard (default) vector table
- bit 14 **DISI:** DISI Instruction Status bit
 1 = DISI instruction is active
 0 = DISI instruction is not active
- bit 13-3 **Unimplemented:** Read as '0'
- bit 2 **INT2EP:** External Interrupt 2 Edge Detect Polarity Select bit
 1 = Interrupt on negative edge
 0 = Interrupt on positive edge
- bit 1 **INT1EP:** External Interrupt 1 Edge Detect Polarity Select bit
 1 = Interrupt on negative edge
 0 = Interrupt on positive edge
- bit 0 **INT0EP:** External Interrupt 0 Edge Detect Polarity Select bit
 1 = Interrupt on negative edge
 0 = Interrupt on positive edge

REGISTER 7-5: IFS0: INTERRUPT FLAG STATUS REGISTER 0

U-0	R/W-0	R/W-0	R/W-0	R/W-0	R/W-0	R/W-0	R/W-0
—	DMA1IF	AD1IF	U1TXIF	U1RXIF	SPI1IF	SPI1EIF	T3IF
bit 15							bit 8

R/W-0	R/W-0	R/W-0	R/W-0	R/W-0	R/W-0	R/W-0	R/W-0
T2IF	OC2IF	IC2IF	DMA0IF	T1IF	OC1IF	IC1IF	INT0IF
bit 7							bit 0

Legend:			
R = Readable bit	W = Writable bit	U = Unimplemented bit, read as '0'	
-n = Value at POR	'1' = Bit is set	'0' = Bit is cleared	x = Bit is unknown

- bit 15 **Unimplemented:** Read as '0'
- bit 14 **DMA1IF:** DMA Channel 1 Data Transfer Complete Interrupt Flag Status bit
 1 = Interrupt request has occurred
 0 = Interrupt request has not occurred
- bit 13 **AD1IF:** ADC1 Conversion Complete Interrupt Flag Status bit
 1 = Interrupt request has occurred
 0 = Interrupt request has not occurred
- bit 12 **U1TXIF:** UART1 Transmitter Interrupt Flag Status bit
 1 = Interrupt request has occurred
 0 = Interrupt request has not occurred
- bit 11 **U1RXIF:** UART1 Receiver Interrupt Flag Status bit
 1 = Interrupt request has occurred
 0 = Interrupt request has not occurred
- bit 10 **SPI1IF:** SPI1 Event Interrupt Flag Status bit
 1 = Interrupt request has occurred
 0 = Interrupt request has not occurred
- bit 9 **SPI1EIF:** SPI1 Error Interrupt Flag Status bit
 1 = Interrupt request has occurred
 0 = Interrupt request has not occurred
- bit 8 **T3IF:** Timer3 Interrupt Flag Status bit
 1 = Interrupt request has occurred
 0 = Interrupt request has not occurred
- bit 7 **T2IF:** Timer2 Interrupt Flag Status bit
 1 = Interrupt request has occurred
 0 = Interrupt request has not occurred
- bit 6 **OC2IF:** Output Compare Channel 2 Interrupt Flag Status bit
 1 = Interrupt request has occurred
 0 = Interrupt request has not occurred
- bit 5 **IC2IF:** Input Capture Channel 2 Interrupt Flag Status bit
 1 = Interrupt request has occurred
 0 = Interrupt request has not occurred
- bit 4 **DMA0IF:** DMA Channel 0 Data Transfer Complete Interrupt Flag Status bit
 1 = Interrupt request has occurred
 0 = Interrupt request has not occurred
- bit 3 **T1IF:** Timer1 Interrupt Flag Status bit
 1 = Interrupt request has occurred
 0 = Interrupt request has not occurred

REGISTER 7-5: IFS0: INTERRUPT FLAG STATUS REGISTER 0 (CONTINUED)

- bit 2 **OC1IF:** Output Compare Channel 1 Interrupt Flag Status bit
1 = Interrupt request has occurred
0 = Interrupt request has not occurred

- bit 1 **IC1IF:** Input Capture Channel 1 Interrupt Flag Status bit
1 = Interrupt request has occurred
0 = Interrupt request has not occurred

- bit 0 **INT0IF:** External Interrupt 0 Flag Status bit
1 = Interrupt request has occurred
0 = Interrupt request has not occurred

REGISTER 7-6: IFS1: INTERRUPT FLAG STATUS REGISTER 1

R/W-0	R/W-0	R/W-0	R/W-0	R/W-0	R/W-0	R/W-0	R/W-0
U2TXIF	U2RXIF	INT2IF	T5IF	T4IF	OC4IF	OC3IF	DMA2IF
bit 15							bit 8

R/W-0	R/W-0	U-0	R/W-0	R/W-0	R/W-0	R/W-0	R/W-0
IC8IF	IC7IF	—	INT1IF	CNIF	CMIF	MI2C1IF	SI2C1IF
bit 7							bit 0

Legend:			
R = Readable bit	W = Writable bit	U = Unimplemented bit, read as '0'	
-n = Value at POR	'1' = Bit is set	'0' = Bit is cleared	x = Bit is unknown

- bit 15 **U2TXIF:** UART2 Transmitter Interrupt Flag Status bit
 1 = Interrupt request has occurred
 0 = Interrupt request has not occurred
- bit 14 **U2RXIF:** UART2 Receiver Interrupt Flag Status bit
 1 = Interrupt request has occurred
 0 = Interrupt request has not occurred
- bit 13 **INT2IF:** External Interrupt 2 Flag Status bit
 1 = Interrupt request has occurred
 0 = Interrupt request has not occurred
- bit 12 **T5IF:** Timer5 Interrupt Flag Status bit
 1 = Interrupt request has occurred
 0 = Interrupt request has not occurred
- bit 11 **T4IF:** Timer4 Interrupt Flag Status bit
 1 = Interrupt request has occurred
 0 = Interrupt request has not occurred
- bit 10 **OC4IF:** Output Compare Channel 4 Interrupt Flag Status bit
 1 = Interrupt request has occurred
 0 = Interrupt request has not occurred
- bit 9 **OC3IF:** Output Compare Channel 3 Interrupt Flag Status bit
 1 = Interrupt request has occurred
 0 = Interrupt request has not occurred
- bit 8 **DMA2IF:** DMA Channel 2 Data Transfer Complete Interrupt Flag Status bit
 1 = Interrupt request has occurred
 0 = Interrupt request has not occurred
- bit 7 **IC8IF:** Input Capture Channel 8 Interrupt Flag Status bit
 1 = Interrupt request has occurred
 0 = Interrupt request has not occurred
- bit 6 **IC7IF:** Input Capture Channel 7 Interrupt Flag Status bit
 1 = Interrupt request has occurred
 0 = Interrupt request has not occurred
- bit 5 **Unimplemented:** Read as '0'
- bit 4 **INT1IF:** External Interrupt 1 Flag Status bit
 1 = Interrupt request has occurred
 0 = Interrupt request has not occurred
- bit 3 **CNIF:** Input Change Notification Interrupt Flag Status bit
 1 = Interrupt request has occurred
 0 = Interrupt request has not occurred

REGISTER 7-6: IFS1: INTERRUPT FLAG STATUS REGISTER 1 (CONTINUED)

- bit 2 **CMIF:** Comparator Interrupt Flag Status bit
1 = Interrupt request has occurred
0 = Interrupt request has not occurred

- bit 1 **MI2C1IF:** I2C1 Master Events Interrupt Flag Status bit
1 = Interrupt request has occurred
0 = Interrupt request has not occurred

- bit 0 **SI2C1IF:** I2C1 Slave Events Interrupt Flag Status bit
1 = Interrupt request has occurred
0 = Interrupt request has not occurred

REGISTER 7-7: IFS2: INTERRUPT FLAG STATUS REGISTER 2

U-0	R/W-0	R/W-0	U-0	U-0	U-0	U-0	U-0
—	DMA4IF	PMPIF	—	—	—	—	—
bit 15						bit 8	

U-0	U-0	U-0	R/W-0	R/W-0	R/W-0	R/W-0	R/W-0
—	—	—	DMA3IF	C1IF ⁽¹⁾	C1RXIF ⁽¹⁾	SPI2IF	SPI2EIF
bit 7						bit 0	

Legend:			
R = Readable bit	W = Writable bit	U = Unimplemented bit, read as '0'	
-n = Value at POR	'1' = Bit is set	'0' = Bit is cleared	x = Bit is unknown

- bit 15 **Unimplemented:** Read as '0'
- bit 14 **DMA4IF:** DMA Channel 4 Data Transfer Complete Interrupt Flag Status bit
 1 = Interrupt request has occurred
 0 = Interrupt request has not occurred
- bit 13 **PMPIF:** Parallel Master Port Interrupt Flag Status bit
 1 = Interrupt request has occurred
 0 = Interrupt request has not occurred
- bit 12-5 **Unimplemented:** Read as '0'
- bit 4 **DMA3IF:** DMA Channel 3 Data Transfer Complete Interrupt Flag Status bit
 1 = Interrupt request has occurred
 0 = Interrupt request has not occurred
- bit 3 **C1IF:** ECAN1 Event Interrupt Flag Status bit⁽¹⁾
 1 = Interrupt request has occurred
 0 = Interrupt request has not occurred
- bit 2 **C1RXIF:** ECAN1 Receive Data Ready Interrupt Flag Status bit⁽¹⁾
 1 = Interrupt request has occurred
 0 = Interrupt request has not occurred
- bit 1 **SPI2IF:** SPI2 Event Interrupt Flag Status bit
 1 = Interrupt request has occurred
 0 = Interrupt request has not occurred
- bit 0 **SPI2EIF:** SPI2 Error Interrupt Flag Status bit
 1 = Interrupt request has occurred
 0 = Interrupt request has not occurred

Note 1: Interrupts disabled on devices without ECAN™ modules.

PIC24HJ32GP302/304, PIC24HJ64GPX02/X04 AND PIC24HJ128GPX02/X04

REGISTER 7-8: IFS3: INTERRUPT FLAG STATUS REGISTER 3

U-0	R/W-0	R/W-0	U-0	U-0	U-0	U-0	U-0
—	RTCIF	DMA5IF	—	—	—	—	—
bit 15						bit 8	

U-0	U-0	U-0	U-0	U-0	U-0	U-0	U-0
—	—	—	—	—	—	—	—
bit 7						bit 0	

Legend:

R = Readable bit

W = Writable bit

U = Unimplemented bit, read as '0'

-n = Value at POR

'1' = Bit is set

'0' = Bit is cleared

x = Bit is unknown

bit 15 **Unimplemented:** Read as '0'

bit 14 **RTCIF:** Real-Time Clock and Calendar Interrupt Flag Status bit

1 = Interrupt request has occurred

0 = Interrupt request has not occurred

bit 13 **DMA5IF:** DMA Channel 5 Data Transfer Complete Interrupt Flag Status bit

1 = Interrupt request has occurred

0 = Interrupt request has not occurred

bit 12-0 **Unimplemented:** Read as '0'

REGISTER 7-9: IFS4: INTERRUPT FLAG STATUS REGISTER 4

U-0	U-0	U-0	U-0	U-0	U-0	U-0	U-0
—	—	—	—	—	—	—	—
bit 15							bit 8
U-0	R/W-0	R/W-0	R/W-0	R/W-0	R/W-0	R/W-0	U-0
—	C1TXIF ⁽¹⁾	DMA7IF	DMA6IF	CRCIF	U2EIF	U1EIF	—
bit 7							bit 0

Legend:
 R = Readable bit W = Writable bit U = Unimplemented bit, read as '0'
 -n = Value at POR '1' = Bit is set '0' = Bit is cleared x = Bit is unknown

- bit 15-7 **Unimplemented:** Read as '0'
- bit 6 **C1TXIF:** ECAN1 Transmit Data Request Interrupt Flag Status bit⁽¹⁾
 1 = Interrupt request has occurred
 0 = Interrupt request has not occurred
- bit 5 **DMA7IF:** DMA Channel 7 Data Transfer Complete Interrupt Flag Status bit
 1 = Interrupt request has occurred
 0 = Interrupt request has not occurred
- bit 4 **DMA6IF:** DMA Channel 6 Data Transfer Complete Interrupt Flag Status bit
 1 = Interrupt request has occurred
 0 = Interrupt request has not occurred
- bit 3 **CRCIF:** CRC Generator Interrupt Flag Status bit
 1 = Interrupt request has occurred
 0 = Interrupt request has not occurred
- bit 2 **U2EIF:** UART2 Error Interrupt Flag Status bit
 1 = Interrupt request has occurred
 0 = Interrupt request has not occurred
- bit 1 **U1EIF:** UART1 Error Interrupt Flag Status bit
 1 = Interrupt request has occurred
 0 = Interrupt request has not occurred
- bit 0 **Unimplemented:** Read as '0'

Note 1: Interrupts disabled on devices without ECAN™ modules.

PIC24HJ32GP302/304, PIC24HJ64GPX02/X04 AND PIC24HJ128GPX02/X04

REGISTER 7-10: IEC0: INTERRUPT ENABLE CONTROL REGISTER 0

U-0	R/W-0	R/W-0	R/W-0	R/W-0	R/W-0	R/W-0	R/W-0
—	DMA1IE	AD1IE	U1TXIE	U1RXIE	SPI1IE	SPI1EIE	T3IE
bit 15							bit 8

R/W-0	R/W-0	R/W-0	R/W-0	R/W-0	R/W-0	R/W-0	R/W-0
T2IE	OC2IE	IC2IE	DMA0IE	T1IE	OC1IE	IC1IE	INT0IE
bit 7							bit 0

Legend:

R = Readable bit	W = Writable bit	U = Unimplemented bit, read as '0'
-n = Value at POR	'1' = Bit is set	'0' = Bit is cleared
		x = Bit is unknown

- bit 15 **Unimplemented:** Read as '0'
- bit 14 **DMA1IE:** DMA Channel 1 Data Transfer Complete Interrupt Enable bit
1 = Interrupt request enabled
0 = Interrupt request not enabled
- bit 13 **AD1IE:** ADC1 Conversion Complete Interrupt Enable bit
1 = Interrupt request enabled
0 = Interrupt request not enabled
- bit 12 **U1TXIE:** UART1 Transmitter Interrupt Enable bit
1 = Interrupt request enabled
0 = Interrupt request not enabled
- bit 11 **U1RXIE:** UART1 Receiver Interrupt Enable bit
1 = Interrupt request enabled
0 = Interrupt request not enabled
- bit 10 **SPI1IE:** SPI1 Event Interrupt Enable bit
1 = Interrupt request enabled
0 = Interrupt request not enabled
- bit 9 **SPI1EIE:** SPI1 Error Interrupt Enable bit
1 = Interrupt request enabled
0 = Interrupt request not enabled
- bit 8 **T3IE:** Timer3 Interrupt Enable bit
1 = Interrupt request enabled
0 = Interrupt request not enabled
- bit 7 **T2IE:** Timer2 Interrupt Enable bit
1 = Interrupt request enabled
0 = Interrupt request not enabled
- bit 6 **OC2IE:** Output Compare Channel 2 Interrupt Enable bit
1 = Interrupt request enabled
0 = Interrupt request not enabled
- bit 5 **IC2IE:** Input Capture Channel 2 Interrupt Enable bit
1 = Interrupt request enabled
0 = Interrupt request not enabled
- bit 4 **DMA0IE:** DMA Channel 0 Data Transfer Complete Interrupt Enable bit
1 = Interrupt request enabled
0 = Interrupt request not enabled
- bit 3 **T1IE:** Timer1 Interrupt Enable bit
1 = Interrupt request enabled
0 = Interrupt request not enabled

REGISTER 7-10: IEC0: INTERRUPT ENABLE CONTROL REGISTER 0 (CONTINUED)

- bit 2 **OC1IE:** Output Compare Channel 1 Interrupt Enable bit
 1 = Interrupt request enabled
 0 = Interrupt request not enabled
- bit 1 **IC1IE:** Input Capture Channel 1 Interrupt Enable bit
 1 = Interrupt request enabled
 0 = Interrupt request not enabled
- bit 0 **INT0IE:** External Interrupt 0 Flag Status bit
 1 = Interrupt request enabled
 0 = Interrupt request not enabled

PIC24HJ32GP302/304, PIC24HJ64GPX02/X04 AND PIC24HJ128GPX02/X04

REGISTER 7-11: IEC1: INTERRUPT ENABLE CONTROL REGISTER 1

R/W-0	R/W-0	R/W-0	R/W-0	R/W-0	R/W-0	R/W-0	R/W-0
U2TXIE	U2RXIE	INT2IE	T5IE	T4IE	OC4IE	OC3IE	DMA2IE
bit 15							bit 8

R/W-0	R/W-0	U-0	R/W-0	R/W-0	R/W-0	R/W-0	R/W-0
IC8IE	IC7IE	—	INT1IE	CNIE	CMIE	MI2C1IE	SI2C1IE
bit 7							bit 0

Legend:

R = Readable bit W = Writable bit U = Unimplemented bit, read as '0'
 -n = Value at POR '1' = Bit is set '0' = Bit is cleared x = Bit is unknown

- bit 15 **U2TXIE:** UART2 Transmitter Interrupt Enable bit
 1 = Interrupt request enabled
 0 = Interrupt request not enabled
- bit 14 **U2RXIE:** UART2 Receiver Interrupt Enable bit
 1 = Interrupt request enabled
 0 = Interrupt request not enabled
- bit 13 **INT2IE:** External Interrupt 2 Enable bit
 1 = Interrupt request enabled
 0 = Interrupt request not enabled
- bit 12 **T5IE:** Timer5 Interrupt Enable bit
 1 = Interrupt request enabled
 0 = Interrupt request not enabled
- bit 11 **T4IE:** Timer4 Interrupt Enable bit
 1 = Interrupt request enabled
 0 = Interrupt request not enabled
- bit 10 **OC4IE:** Output Compare Channel 4 Interrupt Enable bit
 1 = Interrupt request enabled
 0 = Interrupt request not enabled
- bit 9 **OC3IE:** Output Compare Channel 3 Interrupt Enable bit
 1 = Interrupt request enabled
 0 = Interrupt request not enabled
- bit 8 **DMA2IE:** DMA Channel 2 Data Transfer Complete Interrupt Enable bit
 1 = Interrupt request enabled
 0 = Interrupt request not enabled
- bit 7 **IC8IE:** Input Capture Channel 8 Interrupt Enable bit
 1 = Interrupt request enabled
 0 = Interrupt request not enabled
- bit 6 **IC7IE:** Input Capture Channel 7 Interrupt Enable bit
 1 = Interrupt request enabled
 0 = Interrupt request not enabled
- bit 5 **Unimplemented:** Read as '0'
- bit 4 **INT1IE:** External Interrupt 1 Enable bit
 1 = Interrupt request enabled
 0 = Interrupt request not enabled
- bit 3 **CNIE:** Input Change Notification Interrupt Enable bit
 1 = Interrupt request enabled
 0 = Interrupt request not enabled

REGISTER 7-11: IEC1: INTERRUPT ENABLE CONTROL REGISTER 1 (CONTINUED)

- bit 2 **CMIE:** Comparator Interrupt Enable bit
 1 = Interrupt request enabled
 0 = Interrupt request not enabled
- bit 1 **M12C1IE:** I2C1 Master Events Interrupt Enable bit
 1 = Interrupt request enabled
 0 = Interrupt request not enabled
- bit 0 **S12C1IE:** I2C1 Slave Events Interrupt Enable bit
 1 = Interrupt request enabled
 0 = Interrupt request not enabled

PIC24HJ32GP302/304, PIC24HJ64GPX02/X04 AND PIC24HJ128GPX02/X04

REGISTER 7-12: IEC2: INTERRUPT ENABLE CONTROL REGISTER 2

U-0	R/W-0	R/W-0	U-0	U-0	U-0	U-0	U-0
—	DMA4IE	PMPIE	—	—	—	—	—
bit 15							bit 8

U-0	U-0	U-0	R/W-0	R/W-0	R/W-0	R/W-0	R/W-0
—	—	—	DMA3IE	C1IE ⁽¹⁾	C1RXIE ⁽¹⁾	SPI2IE	SPI2EIE
bit 7							bit 0

Legend:

R = Readable bit W = Writable bit U = Unimplemented bit, read as '0'
 -n = Value at POR '1' = Bit is set '0' = Bit is cleared x = Bit is unknown

- bit 15 **Unimplemented:** Read as '0'
- bit 14 **DMA4IE:** DMA Channel 4 Data Transfer Complete Interrupt Enable bit
 1 = Interrupt request enabled
 0 = Interrupt request not enabled
- bit 13 **PMPIE:** Parallel Master Port Interrupt Enable bit
 1 = Interrupt request enabled
 0 = Interrupt request not enabled
- bit 12-5 **Unimplemented:** Read as '0'
- bit 4 **DMA3IE:** DMA Channel 3 Data Transfer Complete Interrupt Enable bit
 1 = Interrupt request enabled
 0 = Interrupt request has enabled
- bit 3 **C1IE:** ECAN1 Event Interrupt Enable bit⁽¹⁾
 1 = Interrupt request enabled
 0 = Interrupt request not enabled
- bit 2 **C1RXIE:** ECAN1 Receive Data Ready Interrupt Enable bit⁽¹⁾
 1 = Interrupt request enabled
 0 = Interrupt request not enabled
- bit 1 **SPI2IE:** SPI2 Event Interrupt Enable bit
 1 = Interrupt request enabled
 0 = Interrupt request not enabled
- bit 0 **SPI2EIE:** SPI2 Error Interrupt Enable bit
 1 = Interrupt request enabled
 0 = Interrupt request not enabled

Note 1: Interrupts disabled on devices without ECAN™ modules.

REGISTER 7-13: IEC3: INTERRUPT ENABLE CONTROL REGISTER 3

U-0	R/W-0	R/W-0	U-0	U-0	U-0	U-0	U-0
—	RTCIE	DMA5IE	—	—	—	—	—
bit 15						bit 8	

U-0	U-0	U-0	U-0	U-0	U-0	U-0	U-0
—	—	—	—	—	—	—	—
bit 7						bit 0	

Legend:			
R = Readable bit	W = Writable bit	U = Unimplemented bit, read as '0'	
-n = Value at POR	'1' = Bit is set	'0' = Bit is cleared	x = Bit is unknown

- bit 15 **Unimplemented:** Read as '0'
- bit 14 **RTCIE:** Real-Time Clock and Calendar Interrupt Enable bit
 - 1 = Interrupt request enabled
 - 0 = Interrupt request not enabled
- bit 13 **DMA5IE:** DMA Channel 5 Data Transfer Complete Interrupt Enable bit
 - 1 = Interrupt request enabled
 - 0 = Interrupt request not enabled
- bit 12-0 **Unimplemented:** Read as '0'

REGISTER 7-14: IEC4: INTERRUPT ENABLE CONTROL REGISTER 4

U-0	U-0	U-0	U-0	U-0	U-0	U-0	U-0
—	—	—	—	—	—	—	—
bit 15							bit 8
U-0	R/W-0	R/W-0	R/W-0	R/W-0	R/W-0	R/W-0	U-0
—	C1TXIE ⁽¹⁾	DMA7IE	DMA6IE	CRCIE	U2EIE	U1EIE	—
bit 7							bit 0

Legend:

R = Readable bit W = Writable bit U = Unimplemented bit, read as '0'
 -n = Value at POR '1' = Bit is set '0' = Bit is cleared x = Bit is unknown

- bit 15-7 **Unimplemented:** Read as '0'
- bit 6 **C1TXIE:** ECAN1 Transmit data request Interrupt Enable bit⁽¹⁾
 1 = Interrupt request occurred
 0 = Interrupt request not occurred
- bit 5 **DMA7IE:** DMA Channel 7 Data Transfer Complete Interrupt Enable bit
 1 = Interrupt request enabled
 0 = Interrupt request not enabled
- bit 4 **DMA6IE:** DMA Channel 6 Data Transfer Complete Interrupt Enable bit
 1 = Interrupt request enabled
 0 = Interrupt request not enabled
- bit 3 **CRCIE:** CRC Generator Interrupt Enable bit
 1 = Interrupt request enabled
 0 = Interrupt request not enabled
- bit 2 **U2EIE:** UART2 Error Interrupt Enable bit
 1 = Interrupt request enabled
 0 = Interrupt request not enabled
- bit 1 **U1EIE:** UART1 Error Interrupt Enable bit
 1 = Interrupt request enabled
 0 = Interrupt request not enabled
- bit 0 **Unimplemented:** Read as '0'

Note 1: Interrupts disabled on devices without ECAN™ modules.

REGISTER 7-15: IPC0: INTERRUPT PRIORITY CONTROL REGISTER 0

U-0	R/W-1	R/W-0	R/W-0	U-0	R/W-1	R/W-0	R/W-0
—	T1IP<2:0>			—	OC1IP<2:0>		
bit 15							bit 8

U-0	R/W-1	R/W-0	R/W-0	U-0	R/W-1	R/W-0	R/W-0
—	IC1IP<2:0>			—	INT0IP<2:0>		
bit 7							bit 0

Legend:			
R = Readable bit	W = Writable bit	U = Unimplemented bit, read as '0'	
-n = Value at POR	'1' = Bit is set	'0' = Bit is cleared	x = Bit is unknown

- bit 15 **Unimplemented:** Read as '0'
- bit 14-12 **T1IP<2:0>:** Timer1 Interrupt Priority bits
 - 111 = Interrupt is priority 7 (highest priority interrupt)
 -
 -
 -
 - 001 = Interrupt is priority 1
 - 000 = Interrupt source is disabled
- bit 11 **Unimplemented:** Read as '0'
- bit 10-8 **OC1IP<2:0>:** Output Compare Channel 1 Interrupt Priority bits
 - 111 = Interrupt is priority 7 (highest priority interrupt)
 -
 -
 -
 - 001 = Interrupt is priority 1
 - 000 = Interrupt source is disabled
- bit 7 **Unimplemented:** Read as '0'
- bit 6-4 **IC1IP<2:0>:** Input Capture Channel 1 Interrupt Priority bits
 - 111 = Interrupt is priority 7 (highest priority interrupt)
 -
 -
 -
 - 001 = Interrupt is priority 1
 - 000 = Interrupt source is disabled
- bit 3 **Unimplemented:** Read as '0'
- bit 2-0 **INT0IP<2:0>:** External Interrupt 0 Priority bits
 - 111 = Interrupt is priority 7 (highest priority interrupt)
 -
 -
 -
 - 001 = Interrupt is priority 1
 - 000 = Interrupt source is disabled

PIC24HJ32GP302/304, PIC24HJ64GPX02/X04 AND PIC24HJ128GPX02/X04

REGISTER 7-16: IPC1: INTERRUPT PRIORITY CONTROL REGISTER 1

U-0	R/W-1	R/W-0	R/W-0	U-0	R/W-1	R/W-0	R/W-0
—	T2IP<2:0>			—	OC2IP<2:0>		
bit 15				bit 8			

U-0	R/W-1	R/W-0	R/W-0	U-0	R/W-1	R/W-0	R/W-0
—	IC2IP<2:0>			—	DMA0IP<2:0>		
bit 7				bit 0			

Legend:

R = Readable bit

W = Writable bit

U = Unimplemented bit, read as '0'

-n = Value at POR

'1' = Bit is set

'0' = Bit is cleared

x = Bit is unknown

bit 15 **Unimplemented:** Read as '0'

bit 14-12 **T2IP<2:0>:** Timer2 Interrupt Priority bits
 111 = Interrupt is priority 7 (highest priority interrupt)
 •
 •
 •
 001 = Interrupt is priority 1
 000 = Interrupt source is disabled

bit 11 **Unimplemented:** Read as '0'

bit 10-8 **OC2IP<2:0>:** Output Compare Channel 2 Interrupt Priority bits
 111 = Interrupt is priority 7 (highest priority interrupt)
 •
 •
 •
 001 = Interrupt is priority 1
 000 = Interrupt source is disabled

bit 7 **Unimplemented:** Read as '0'

bit 6-4 **IC2IP<2:0>:** Input Capture Channel 2 Interrupt Priority bits
 111 = Interrupt is priority 7 (highest priority interrupt)
 •
 •
 •
 001 = Interrupt is priority 1
 000 = Interrupt source is disabled

bit 3 **Unimplemented:** Read as '0'

bit 2-0 **DMA0IP<2:0>:** DMA Channel 0 Data Transfer Complete Interrupt Priority bits
 111 = Interrupt is priority 7 (highest priority interrupt)
 •
 •
 •
 001 = Interrupt is priority 1
 000 = Interrupt source is disabled

REGISTER 7-17: IPC2: INTERRUPT PRIORITY CONTROL REGISTER 2

U-0	R/W-1	R/W-0	R/W-0	U-0	R/W-1	R/W-0	R/W-0
—	U1RXIP<2:0>			—	SPI1IP<2:0>		
bit 15							bit 8

U-0	R/W-1	R/W-0	R/W-0	U-0	R/W-1	R/W-0	R/W-0
—	SPI1EIP<2:0>			—	T3IP<2:0>		
bit 7							bit 0

Legend:			
R = Readable bit	W = Writable bit	U = Unimplemented bit, read as '0'	
-n = Value at POR	'1' = Bit is set	'0' = Bit is cleared	x = Bit is unknown

- bit 15 **Unimplemented:** Read as '0'
- bit 14-12 **U1RXIP<2:0>:** UART1 Receiver Interrupt Priority bits
 - 111 = Interrupt is priority 7 (highest priority interrupt)
 -
 -
 -
 - 001 = Interrupt is priority 1
 - 000 = Interrupt source is disabled
- bit 11 **Unimplemented:** Read as '0'
- bit 10-8 **SPI1IP<2:0>:** SPI1 Event Interrupt Priority bits
 - 111 = Interrupt is priority 7 (highest priority interrupt)
 -
 -
 -
 - 001 = Interrupt is priority 1
 - 000 = Interrupt source is disabled
- bit 7 **Unimplemented:** Read as '0'
- bit 6-4 **SPI1EIP<2:0>:** SPI1 Error Interrupt Priority bits
 - 111 = Interrupt is priority 7 (highest priority interrupt)
 -
 -
 -
 - 001 = Interrupt is priority 1
 - 000 = Interrupt source is disabled
- bit 3 **Unimplemented:** Read as '0'
- bit 2-0 **T3IP<2:0>:** Timer3 Interrupt Priority bits
 - 111 = Interrupt is priority 7 (highest priority interrupt)
 -
 -
 -
 - 001 = Interrupt is priority 1
 - 000 = Interrupt source is disabled

PIC24HJ32GP302/304, PIC24HJ64GPX02/X04 AND PIC24HJ128GPX02/X04

REGISTER 7-18: IPC3: INTERRUPT PRIORITY CONTROL REGISTER 3

U-0	U-0	U-0	U-0	U-0	R/W-1	R/W-0	R/W-0
—	—	—	—	—	DMA1IP<2:0>		
bit 15					bit 8		

U-0	R/W-1	R/W-0	R/W-0	U-0	R/W-1	R/W-0	R/W-0
—	AD1IP<2:0>			—	U1TXIP<2:0>		
bit 7				bit 0			

Legend:

R = Readable bit	W = Writable bit	U = Unimplemented bit, read as '0'
-n = Value at POR	'1' = Bit is set	'0' = Bit is cleared x = Bit is unknown

- bit 15-11 **Unimplemented:** Read as '0'
- bit 10-8 **DMA1IP<2:0>:** DMA Channel 1 Data Transfer Complete Interrupt Priority bits
 - 111 = Interrupt is priority 7 (highest priority interrupt)
 -
 -
 -
 - 001 = Interrupt is priority 1
 - 000 = Interrupt source is disabled
- bit 7 **Unimplemented:** Read as '0'
- bit 6-4 **AD1IP<2:0>:** ADC1 Conversion Complete Interrupt Priority bits
 - 111 = Interrupt is priority 7 (highest priority interrupt)
 -
 -
 -
 - 001 = Interrupt is priority 1
 - 000 = Interrupt source is disabled
- bit 3 **Unimplemented:** Read as '0'
- bit 2-0 **U1TXIP<2:0>:** UART1 Transmitter Interrupt Priority bits
 - 111 = Interrupt is priority 7 (highest priority interrupt)
 -
 -
 -
 - 001 = Interrupt is priority 1
 - 000 = Interrupt source is disabled

REGISTER 7-19: IPC4: INTERRUPT PRIORITY CONTROL REGISTER 4

U-0	R/W-1	R/W-0	R/W-0	U-0	R/W-1	R/W-0	R/W-0
—	CNIP<2:0>			—	CMIP<2:0>		
bit 15							bit 8

U-0	R/W-1	R/W-0	R/W-0	U-0	R/W-1	R/W-0	R/W-0
—	MI2C1IP<2:0>			—	SI2C1IP<2:0>		
bit 7							bit 0

Legend:			
R = Readable bit	W = Writable bit	U = Unimplemented bit, read as '0'	
-n = Value at POR	'1' = Bit is set	'0' = Bit is cleared	x = Bit is unknown

- bit 15 **Unimplemented:** Read as '0'
- bit 14-12 **CNIP<2:0>:** Change Notification Interrupt Priority bits
 - 111 = Interrupt is priority 7 (highest priority interrupt)
 -
 -
 -
 - 001 = Interrupt is priority 1
 - 000 = Interrupt source is disabled
- bit 11 **Unimplemented:** Read as '0'
- bit 10-8 **CMIP<2:0>:** Comparator Interrupt Priority bits
 - 111 = Interrupt is priority 7 (highest priority interrupt)
 -
 -
 -
 - 001 = Interrupt is priority 1
 - 000 = Interrupt source is disabled
- bit 7 **Unimplemented:** Read as '0'
- bit 6-4 **MI2C1IP<2:0>:** I2C1 Master Events Interrupt Priority bits
 - 111 = Interrupt is priority 7 (highest priority interrupt)
 -
 -
 -
 - 001 = Interrupt is priority 1
 - 000 = Interrupt source is disabled
- bit 3 **Unimplemented:** Read as '0'
- bit 2-0 **SI2C1IP<2:0>:** I2C1 Slave Events Interrupt Priority bits
 - 111 = Interrupt is priority 7 (highest priority interrupt)
 -
 -
 -
 - 001 = Interrupt is priority 1
 - 000 = Interrupt source is disabled

PIC24HJ32GP302/304, PIC24HJ64GPX02/X04 AND PIC24HJ128GPX02/X04

REGISTER 7-20: IPC5: INTERRUPT PRIORITY CONTROL REGISTER 5

U-0	R/W-1	R/W-0	R/W-0	U-0	R/W-1	R/W-0	R/W-0
—	IC8IP<2:0>			—	IC7IP<2:0>		
bit 15				bit 8			

U-0	U-1	U-0	U-0	U-0	R/W-1	R/W-0	R/W-0
—	—	—	—	—	INT1IP<2:0>		
bit 7					bit 0		

Legend:

R = Readable bit	W = Writable bit	U = Unimplemented bit, read as '0'
-n = Value at POR	'1' = Bit is set	'0' = Bit is cleared x = Bit is unknown

- bit 15 **Unimplemented:** Read as '0'
- bit 14-12 **IC8IP<2:0>:** Input Capture Channel 8 Interrupt Priority bits
 - 111 = Interrupt is priority 7 (highest priority interrupt)
 -
 -
 -
 - 001 = Interrupt is priority 1
 - 000 = Interrupt source is disabled
- bit 11 **Unimplemented:** Read as '0'
- bit 10-8 **IC7IP<2:0>:** Input Capture Channel 7 Interrupt Priority bits
 - 111 = Interrupt is priority 7 (highest priority interrupt)
 -
 -
 -
 - 001 = Interrupt is priority 1
 - 000 = Interrupt source is disabled
- bit 7-3 **Unimplemented:** Read as '0'
- bit 2-0 **INT1IP<2:0>:** External Interrupt 1 Priority bits
 - 111 = Interrupt is priority 7 (highest priority interrupt)
 -
 -
 -
 - 001 = Interrupt is priority 1
 - 000 = Interrupt source is disabled

REGISTER 7-21: IPC6: INTERRUPT PRIORITY CONTROL REGISTER 6

U-0	R/W-1	R/W-0	R/W-0	U-0	R/W-1	R/W-0	R/W-0
—	T4IP<2:0>			—	OC4IP<2:0>		
bit 15							bit 8

U-0	R/W-1	R/W-0	R/W-0	U-0	R/W-1	R/W-0	R/W-0
—	OC3IP<2:0>			—	DMA2IP<2:0>		
bit 7							bit 0

Legend:			
R = Readable bit	W = Writable bit	U = Unimplemented bit, read as '0'	
-n = Value at POR	'1' = Bit is set	'0' = Bit is cleared	x = Bit is unknown

- bit 15 **Unimplemented:** Read as '0'
- bit 14-12 **T4IP<2:0>:** Timer4 Interrupt Priority bits
 - 111 = Interrupt is priority 7 (highest priority interrupt)
 -
 -
 -
 - 001 = Interrupt is priority 1
 - 000 = Interrupt source is disabled
- bit 11 **Unimplemented:** Read as '0'
- bit 10-8 **OC4IP<2:0>:** Output Compare Channel 4 Interrupt Priority bits
 - 111 = Interrupt is priority 7 (highest priority interrupt)
 -
 -
 -
 - 001 = Interrupt is priority 1
 - 000 = Interrupt source is disabled
- bit 7 **Unimplemented:** Read as '0'
- bit 6-4 **OC3IP<2:0>:** Output Compare Channel 3 Interrupt Priority bits
 - 111 = Interrupt is priority 7 (highest priority interrupt)
 -
 -
 -
 - 001 = Interrupt is priority 1
 - 000 = Interrupt source is disabled
- bit 3 **Unimplemented:** Read as '0'
- bit 2-0 **DMA2IP<2:0>:** DMA Channel 2 Data Transfer Complete Interrupt Priority bits
 - 111 = Interrupt is priority 7 (highest priority interrupt)
 -
 -
 -
 - 001 = Interrupt is priority 1
 - 000 = Interrupt source is disabled

PIC24HJ32GP302/304, PIC24HJ64GPX02/X04 AND PIC24HJ128GPX02/X04

REGISTER 7-22: IPC7: INTERRUPT PRIORITY CONTROL REGISTER 7

U-0	R/W-1	R/W-0	R/W-0	U-0	R/W-1	R/W-0	R/W-0
—	U2TXIP<2:0>			—	U2RXIP<2:0>		
bit 15							bit 8

U-0	R/W-1	R/W-0	R/W-0	U-0	R/W-1	R/W-0	R/W-0
—	INT2IP<2:0>			—	T5IP<2:0>		
bit 7							bit 0

Legend:

R = Readable bit W = Writable bit U = Unimplemented bit, read as '0'
 -n = Value at POR '1' = Bit is set '0' = Bit is cleared x = Bit is unknown

- bit 15 **Unimplemented:** Read as '0'
- bit 14-12 **U2TXIP<2:0>:** UART2 Transmitter Interrupt Priority bits
 - 111 = Interrupt is priority 7 (highest priority interrupt)
 -
 -
 -
 - 001 = Interrupt is priority 1
 - 000 = Interrupt source is disabled
- bit 11 **Unimplemented:** Read as '0'
- bit 10-8 **U2RXIP<2:0>:** UART2 Receiver Interrupt Priority bits
 - 111 = Interrupt is priority 7 (highest priority interrupt)
 -
 -
 -
 - 001 = Interrupt is priority 1
 - 000 = Interrupt source is disabled
- bit 7 **Unimplemented:** Read as '0'
- bit 6-4 **INT2IP<2:0>:** External Interrupt 2 Priority bits
 - 111 = Interrupt is priority 7 (highest priority interrupt)
 -
 -
 -
 - 001 = Interrupt is priority 1
 - 000 = Interrupt source is disabled
- bit 3 **Unimplemented:** Read as '0'
- bit 2-0 **T5IP<2:0>:** Timer5 Interrupt Priority bits
 - 111 = Interrupt is priority 7 (highest priority interrupt)
 -
 -
 -
 - 001 = Interrupt is priority 1
 - 000 = Interrupt source is disabled

REGISTER 7-23: IPC8: INTERRUPT PRIORITY CONTROL REGISTER 8

U-0	R/W-1	R/W-0	R/W-0	U-0	R/W-1	R/W-0	R/W-0
—	C1IP<2:0> ⁽¹⁾			—	C1RXIP<2:0> ⁽¹⁾		
bit 15							bit 8

U-0	R/W-1	R/W-0	R/W-0	U-0	R/W-1	R/W-0	R/W-0
—	SPI2IP<2:0>			—	SPI2EIP<2:0>		
bit 7							bit 0

Legend:			
R = Readable bit	W = Writable bit	U = Unimplemented bit, read as '0'	
-n = Value at POR	'1' = Bit is set	'0' = Bit is cleared	x = Bit is unknown

- bit 15 **Unimplemented:** Read as '0'
- bit 14-12 **C1IP<2:0>:** ECAN1 Event Interrupt Priority bits⁽¹⁾
 - 111 = Interrupt is priority 7 (highest priority interrupt)
 -
 -
 -
 - 001 = Interrupt is priority 1
 - 000 = Interrupt source is disabled
- bit 11 **Unimplemented:** Read as '0'
- bit 10-8 **C1RXIP<2:0>:** ECAN1 Receive Data Ready Interrupt Priority bits⁽¹⁾
 - 111 = Interrupt is priority 7 (highest priority interrupt)
 -
 -
 -
 - 001 = Interrupt is priority 1
 - 000 = Interrupt source is disabled
- bit 7 **Unimplemented:** Read as '0'
- bit 6-4 **SPI2IP<2:0>:** SPI2 Event Interrupt Priority bits
 - 111 = Interrupt is priority 7 (highest priority interrupt)
 -
 -
 -
 - 001 = Interrupt is priority 1
 - 000 = Interrupt source is disabled
- bit 3 **Unimplemented:** Read as '0'
- bit 2-0 **SPI2EIP<2:0>:** SPI2 Error Interrupt Priority bits
 - 111 = Interrupt is priority 7 (highest priority interrupt)
 -
 -
 -
 - 001 = Interrupt is priority 1
 - 000 = Interrupt source is disabled

Note 1: Interrupts disabled on devices without ECAN™ modules.

PIC24HJ32GP302/304, PIC24HJ64GPX02/X04 AND PIC24HJ128GPX02/X04

REGISTER 7-24: IPC9: INTERRUPT PRIORITY CONTROL REGISTER 9

U-0	U-0	U-0	U-0	U-0	U-0	U-0	U-0
—	—	—	—	—	—	—	—
bit 15						bit 8	

U-0	U-0	U-0	U-0	U-0	R/W-1	R/W-0	R/W-0
—	—	—	—	—	DMA3IP<2:0>		
bit 7					bit 0		

Legend:

R = Readable bit W = Writable bit U = Unimplemented bit, read as '0'
 -n = Value at POR '1' = Bit is set '0' = Bit is cleared x = Bit is unknown

- bit 15-3 **Unimplemented:** Read as '0'
- bit 2-0 **DMA3IP<2:0>:** DMA Channel 3 Data Transfer Complete Interrupt Priority bits
 - 111 = Interrupt is priority 7 (highest priority interrupt)
 -
 -
 -
 - 001 = Interrupt is priority 1
 - 000 = Interrupt source is disabled

REGISTER 7-25: IPC11: INTERRUPT PRIORITY CONTROL REGISTER 11

U-0	U-0	U-0	U-0	U-0	R/W-1	R/W-0	R/W-0
—	—	—	—	—	DMA4IP<2:0>		
bit 15					bit 8		

U-0	R/W-1	R/W-0	R/W-0	U-0	U-0	U-0	U-0
—	PMPPIP<2:0>			—	—	—	—
bit 7				bit 0			

Legend:			
R = Readable bit	W = Writable bit	U = Unimplemented bit, read as '0'	
-n = Value at POR	'1' = Bit is set	'0' = Bit is cleared	x = Bit is unknown

- bit 15-11 **Unimplemented:** Read as '0'
- bit 10-8 **DMA4IP<2:0>:** DMA Channel 4 Data Transfer Complete Interrupt Priority bits
 - 111 = Interrupt is priority 7 (highest priority interrupt)
 -
 -
 -
 - 001 = Interrupt is priority 1
 - 000 = Interrupt source is disabled
- bit 7 **Unimplemented:** Read as '0'
- bit 6-4 **PMPPIP<2:0>:** Parallel Master Port Interrupt Priority bits
 - 111 = Interrupt is priority 7 (highest priority interrupt)
 -
 -
 -
 - 001 = Interrupt is priority 1
 - 000 = Interrupt source is disabled
- bit 3-0 **Unimplemented:** Read as '0'

PIC24HJ32GP302/304, PIC24HJ64GPX02/X04 AND PIC24HJ128GPX02/X04

REGISTER 7-26: IPC15: INTERRUPT PRIORITY CONTROL REGISTER 15

U-0	U-0	U-0	U-0	U-0	R/W-1	R/W-0	R/W-0
—	—	—	—	—	RTCIP<2:0>		
bit 15					bit 8		

U-0	R/W-1	R/W-0	R/W-0	U-0	U-0	U-0	U-0
—	DMA5IP<2:0>			—	—	—	—
bit 7				bit 0			

Legend:

R = Readable bit	W = Writable bit	U = Unimplemented bit, read as '0'
-n = Value at POR	'1' = Bit is set	'0' = Bit is cleared x = Bit is unknown

- bit 15-11 **Unimplemented:** Read as '0'
- bit 10-8 **RTCIP<2:0>:** Real-Time Clock and Calendar Interrupt Flag Status bits
 - 111 = Interrupt is priority 7 (highest priority interrupt)
 -
 -
 -
 - 001 = Interrupt is priority 1
 - 000 = Interrupt source is disabled
- bit 7 **Unimplemented:** Read as '0'
- bit 6-4 **DMA5IP<2:0>:** DMA Channel 5 Data Transfer Complete Interrupt Priority bits
 - 111 = Interrupt is priority 7 (highest priority interrupt)
 -
 -
 -
 - 001 = Interrupt is priority 1
 - 000 = Interrupt source is disabled
- bit 3-0 **Unimplemented:** Read as '0'

REGISTER 7-27: IPC16: INTERRUPT PRIORITY CONTROL REGISTER 16

U-0	R/W-1	R/W-0	R/W-0	U-0	R/W-1	R/W-0	R/W-0
—	CRCIP<2:0>			—	U2EIP<2:0>		
bit 15							bit 8

U-0	R/W-1	R/W-0	R/W-0	U-0	U-0	U-0	U-0
—	U1EIP<2:0>			—	—	—	—
bit 7							bit 0

Legend:			
R = Readable bit	W = Writable bit	U = Unimplemented bit, read as '0'	
-n = Value at POR	'1' = Bit is set	'0' = Bit is cleared	x = Bit is unknown

- bit 15 **Unimplemented:** Read as '0'
- bit 14-12 **CRCIP<2:0>:** CRC Generator Error Interrupt Flag Priority bits
 - 111 = Interrupt is priority 7 (highest priority interrupt)
 -
 -
 -
 - 001 = Interrupt is priority 1
 - 000 = Interrupt source is disabled
- bit 11 **Unimplemented:** Read as '0'
- bit 10-8 **U2EIP<2:0>:** UART2 Error Interrupt Priority bits
 - 111 = Interrupt is priority 7 (highest priority interrupt)
 -
 -
 -
 - 001 = Interrupt is priority 1
 - 000 = Interrupt source is disabled
- bit 7 **Unimplemented:** Read as '0'
- bit 6-4 **U1EIP<2:0>:** UART1 Error Interrupt Priority bits
 - 111 = Interrupt is priority 7 (highest priority interrupt)
 -
 -
 -
 - 001 = Interrupt is priority 1
 - 000 = Interrupt source is disabled
- bit 3-0 **Unimplemented:** Read as '0'

PIC24HJ32GP302/304, PIC24HJ64GPX02/X04 AND PIC24HJ128GPX02/X04

REGISTER 7-28: IPC17: INTERRUPT PRIORITY CONTROL REGISTER 17

U-0	U-0	U-0	U-0	U-0	R/W-1	R/W-0	R/W-0
—	—	—	—	—	C1TXIP<2:0> ⁽¹⁾		
bit 15						bit 8	

U-0	R/W-1	R/W-0	R/W-0	U-0	R/W-1	R/W-0	R/W-0
—	DMA7IP<2:0>			—	DMA6IP<2:0>		
bit 7						bit 0	

Legend:

R = Readable bit

W = Writable bit

U = Unimplemented bit, read as '0'

-n = Value at POR

'1' = Bit is set

'0' = Bit is cleared

x = Bit is unknown

bit 15-11 **Unimplemented:** Read as '0'

bit 10-8 **C1TXIP<2:0>:** ECAN1 Transmit Data Request Interrupt Priority bits⁽¹⁾

111 = Interrupt is priority 7 (highest priority interrupt)

•
•
•

001 = Interrupt is priority 1

000 = Interrupt source is disabled

bit 7 **Unimplemented:** Read as '0'

bit 6-4 **DMA7IP<2:0>:** DMA Channel 7 Data Transfer Complete Interrupt Priority bits

111 = Interrupt is priority 7 (highest priority interrupt)

•
•
•

001 = Interrupt is priority 1

000 = Interrupt source is disabled

bit 3 **Unimplemented:** Read as '0'

bit 2-0 **DMA6IP<2:0>:** DMA Channel 6 Data Transfer Complete Interrupt Priority bits

111 = Interrupt is priority 7 (highest priority interrupt)

•
•
•

001 = Interrupt is priority 1

000 = Interrupt source is disabled

Note 1: Interrupts disabled on devices without ECAN™ modules.

REGISTER 7-29: INTTREG: INTERRUPT CONTROL AND STATUS REGISTER

U-0	U-0	U-0	U-0	R-0	R-0	R-0	R-0
—	—	—	—	ILR<3:0>			
bit 15							bit 8

U-0	R-0	R-0	R-0	R-0	R-0	R-0	R-0
—	VECNUM<6:0>						
bit 7							bit 0

Legend:			
R = Readable bit	W = Writable bit	U = Unimplemented bit, read as '0'	
-n = Value at POR	'1' = Bit is set	'0' = Bit is cleared	x = Bit is unknown

- bit 15-12 **Unimplemented:** Read as '0'
- bit 11-8 **ILR:** New CPU Interrupt Priority Level bits
 - 1111 = CPU Interrupt Priority Level is 15
 -
 -
 -
 - 0001 = CPU Interrupt Priority Level is 1
 - 0000 = CPU Interrupt Priority Level is 0
- bit 7 **Unimplemented:** Read as '0'
- bit 6-0 **VECNUM:** Vector Number of Pending Interrupt bits
 - 0111111 = Interrupt Vector pending is number 135
 -
 -
 -
 - 0000001 = Interrupt Vector pending is number 9
 - 0000000 = Interrupt Vector pending is number 8

7.6 Interrupt Setup Procedures

7.6.1 INITIALIZATION

To configure an interrupt source at initialization:

1. Set the NSTDIS bit (INTCON1<15>) if nested interrupts are not desired.
2. Select the user-assigned priority level for the interrupt source by writing the control bits in the appropriate IPCx register. The priority level depends on the specific application and type of interrupt source. If multiple priority levels are not desired, the IPCx register control bits for all enabled interrupt sources can be programmed to the same non-zero value.

Note: At a device Reset, the IPCx registers are initialized such that all user interrupt sources are assigned to priority level 4.

3. Clear the interrupt flag status bit associated with the peripheral in the associated IFSx register.
4. Enable the interrupt source by setting the interrupt enable control bit associated with the source in the appropriate IECx register.

7.6.2 INTERRUPT SERVICE ROUTINE

The method used to declare an ISR and initialize the IVT with the correct vector address depends on the programming language (C or assembler) and the language development tool suite used to develop the application.

In general, the user application must clear the interrupt flag in the appropriate IFSx register for the source of interrupt that the ISR handles. Otherwise, the program re-enters the ISR immediately after exiting the routine. If the ISR is coded in assembly language, it must be terminated using a `RETFIE` instruction to unstack the saved PC value, SRL value and old CPU priority level.

7.6.3 TRAP SERVICE ROUTINE

A Trap Service Routine (TSR) is coded like an ISR, except that the appropriate trap status flag in the INTCON1 register must be cleared to avoid re-entry into the TSR.

7.6.4 INTERRUPT DISABLE

All user interrupts can be disabled using this procedure:

1. Push the current SR value onto the software stack using the `PUSH` instruction.
2. Force the CPU to priority level 7 by inclusive ORing the value 0x0E with SRL.

To enable user interrupts, the `POP` instruction can be used to restore the previous SR value.

Note: Only user interrupts with a priority level of 7 or lower can be disabled. Trap sources (level 8-level 15) cannot be disabled.

The `DISI` instruction provides a convenient way to disable interrupts of priority levels 1-6 for a fixed period of time. Level 7 interrupt sources are not disabled by the `DISI` instruction.

8.0 DIRECT MEMORY ACCESS (DMA)

Note 1: This data sheet summarizes the features of the PIC24HJ32GP302/304, PIC24HJ64GPX02/X04 and PIC24HJ128GPX02/X04 families of devices. It is not intended to be a comprehensive reference source. To complement the information in this data sheet, refer to **Section 38. “Direct Memory Access (DMA) (Part III)”** (DS70215) of the “*dsPIC33F/PIC24H Family Reference Manual*”, which is available from the Microchip web site (www.microchip.com).

2: Some registers and associated bits described in this section may not be available on all devices. Refer to **Section 4.0 “Memory Organization”** in this data sheet for device-specific register and bit information.

Direct Memory Access (DMA) is a very efficient mechanism of copying data between peripheral SFRs (e.g., UART Receive register, Input Capture 1 buffer), and buffers or variables stored in RAM, with minimal CPU intervention. The DMA controller can automatically copy entire blocks of data without requiring the user software to read or write the peripheral Special Function Registers (SFRs) every time a peripheral interrupt occurs. The DMA controller uses a dedicated bus for data transfers and therefore, does not steal cycles from the code execution flow of the CPU. To exploit the DMA capability, the corresponding user buffers or variables must be located in DMA RAM.

The PIC24HJ32GP302/304, PIC24HJ64GPX02/X04 and PIC24HJ128GPX02/X04 peripherals that can utilize DMA are listed in [Table 8-1](#).

TABLE 8-1: DMA CHANNEL TO PERIPHERAL ASSOCIATIONS

Peripheral to DMA Association	DMAxREQ Register IRQSEL<6:0> Bits	DMAxPAD Register Values to Read from Peripheral	DMAxPAD Register Values to Write to Peripheral
INT0 – External Interrupt 0	0000000	—	—
IC1 – Input Capture 1	0000001	0x0140 (IC1BUF)	—
OC1 – Output Compare 1 Data	0000010	—	0x0182 (OC1R)
OC1 – Output Compare 1 Secondary Data	0000010	—	0x0180 (OC1RS)
IC2 – Input Capture 2	0000101	0x0144 (IC2BUF)	—
OC2 – Output Compare 2 Data	0000110	—	0x0188 (OC2R)
OC2 – Output Compare 2 Secondary Data	0000110	—	0x0186 (OC2RS)
TMR2 – Timer2	0000111	—	—
TMR3 – Timer3	0001000	—	—
SPI1 – Transfer Done	0001010	0x0248 (SPI1BUF)	0x0248 (SPI1BUF)
UART1RX – UART1 Receiver	0001011	0x0226 (U1RXREG)	—
UART1TX – UART1 Transmitter	0001100	—	0x0224 (U1TXREG)
ADC1 – ADC1 Convert Done	0001101	0x0300 (ADC1BUF0)	—
UART2RX – UART2 Receiver	0011110	0x0236 (U2RXREG)	—
UART2TX – UART2 Transmitter	0011111	—	0x0234 (U2TXREG)
SPI2 – Transfer Done	0100001	0x0268 (SPI2BUF)	0x0268 (SPI2BUF)
ECAN1 – RX Data Ready	0100010	0x0440 (C1RXD)	—
PMP – Master Data Transfer	0101101	0x0608 (PMDIN1)	0x0608 (PMDIN1)
ECAN1 – TX Data Request	1000110	—	0x0442 (C1TXD)

PIC24HJ32GP302/304, PIC24HJ64GPX02/X04 AND PIC24HJ128GPX02/X04

The DMA controller features eight identical data transfer channels.

Each channel has its own set of control and status registers. Each DMA channel can be configured to copy data either from buffers stored in dual port DMA RAM to peripheral SFRs, or from peripheral SFRs to buffers in DMA RAM.

The DMA controller supports the following features:

- Eight DMA channels
- Register Indirect with Post-increment Addressing mode
- Register Indirect without Post-increment Addressing mode
- Peripheral Indirect Addressing mode (peripheral generates destination address)
- CPU interrupt after half or full block transfer complete

- Byte or word transfers
- Fixed priority channel arbitration
- Manual (software) or Automatic (peripheral DMA requests) transfer initiation
- One-Shot or Auto-Repeat block transfer modes
- Ping-Pong mode (automatic switch between two DPSRAM start addresses after each block transfer complete)
- DMA request for each channel can be selected from any supported interrupt source
- Debug support features

For each DMA channel, a DMA interrupt request is generated when a block transfer is complete. Alternatively, an interrupt can be generated when half of the block has been filled.

FIGURE 8-1: TOP LEVEL SYSTEM ARCHITECTURE USING A DEDICATED TRANSACTION BUS



8.1 DMA Resources

Many useful resources related to DMA are provided on the main product page of the Microchip web site for the devices listed in this data sheet. This product page, which can be accessed using this [link](#), contains the latest updates and additional information.

Note: In the event you are not able to access the product page using the link above, enter this URL in your browser:
<http://www.microchip.com/wwwproducts/Devices.aspx?dDocName=en534555>

8.1.1 KEY RESOURCES

- **Section 38. “Direct Memory Access (DMA) (Part III)” (DS70215)**
- Code Samples
- Application Notes
- Software Libraries
- Webinars
- All related dsPIC33F/PIC24H Family Reference Manuals Sections
- Development Tools

8.2 DMAC Registers

Each DMAC Channel x ($x = 0, 1, 2, 3, 4, 5, 6$ or 7) contains the following registers:

- A 16-bit DMA Channel Control register (DMAxCON)
- A 16-bit DMA Channel IRQ Select register (DMAxREQ)
- A 16-bit DMA RAM Primary Start Address register (DMAxSTA)
- A 16-bit DMA RAM Secondary Start Address register (DMAxSTB)
- A 16-bit DMA Peripheral Address register (DMAxPAD)
- A 10-bit DMA Transfer Count register (DMAxCNT)

An additional pair of status registers, DMACS0 and DMACS1, are common to all DMAC channels. DMACS0 contains the DMA RAM and SFR write collision flags, XWCOLx and PWCOLx, respectively. DMACS1 indicates DMA channel and Ping-Pong mode status.

The DMAxCON, DMAxREQ, DMAxPAD and DMAxCNT are all conventional read/write registers. Reads of DMAxSTA or DMAxSTB reads the contents of the DMA RAM Address register. Writes to DMAxSTA or DMAxSTB write to the registers. This allows the user to determine the DMA buffer pointer value (address) at any time.

The interrupt flags (DMAxIF) are located in an IFSx register in the interrupt controller. The corresponding interrupt enable control bits (DMAxIE) are located in an IECx register in the interrupt controller, and the corresponding interrupt priority control bits (DMAxIP) are located in an IPCx register in the interrupt controller.

8.3 DMA Control Registers

REGISTER 8-1: DMAxCON: DMA CHANNEL x CONTROL REGISTER

R/W-0	R/W-0	R/W-0	R/W-0	R/W-0	U-0	U-0	U-0
CHEN	SIZE	DIR	HALF	NULLW	—	—	—
bit 15						bit 8	

U-0	U-0	R/W-0	R/W-0	U-0	U-0	R/W-0	R/W-0
—	—	AMODE<1:0>		—	—	MODE<1:0>	
bit 7						bit 0	

Legend:

R = Readable bit W = Writable bit U = Unimplemented bit, read as '0'
 -n = Value at POR '1' = Bit is set '0' = Bit is cleared x = Bit is unknown

- bit 15 **CHEN:** Channel Enable bit
 1 = Channel enabled
 0 = Channel disabled
- bit 14 **SIZE:** Data Transfer Size bit
 1 = Byte
 0 = Word
- bit 13 **DIR:** Transfer Direction bit (source/destination bus select)
 1 = Read from DMA RAM address, write to peripheral address
 0 = Read from peripheral address, write to DMA RAM address
- bit 12 **HALF:** Early Block Transfer Complete Interrupt Select bit
 1 = Initiate block transfer complete interrupt when half of the data has been moved
 0 = Initiate block transfer complete interrupt when all of the data has been moved
- bit 11 **NULLW:** Null Data Peripheral Write Mode Select bit
 1 = Null data write to peripheral in addition to DMA RAM write (DIR bit must also be clear)
 0 = Normal operation
- bit 10-6 **Unimplemented:** Read as '0'
- bit 5-4 **AMODE<1:0>:** DMA Channel Operating Mode Select bits
 11 = Reserved (acts as Peripheral Indirect Addressing mode)
 10 = Peripheral Indirect Addressing mode
 01 = Register Indirect without Post-Increment mode
 00 = Register Indirect with Post-Increment mode
- bit 3-2 **Unimplemented:** Read as '0'
- bit 1-0 **MODE<1:0>:** DMA Channel Operating Mode Select bits
 11 = One-Shot, Ping-Pong modes enabled (one block transfer from/to each DMA RAM buffer)
 10 = Continuous, Ping-Pong modes enabled
 01 = One-Shot, Ping-Pong modes disabled
 00 = Continuous, Ping-Pong modes disabled

REGISTER 8-2: DMAxREQ: DMA CHANNEL x IRQ SELECT REGISTER

R/W-0	U-0	U-0	U-0	U-0	U-0	U-0	U-0
FORCE ⁽¹⁾	—	—	—	—	—	—	—
bit 15							bit 8

U-0	R/W-0	R/W-0	R/W-0	U-0	U-0	R/W-0	R/W-0
—	IRQSEL<6:0> ⁽²⁾						
bit 7							bit 0

Legend:			
R = Readable bit	W = Writable bit	U = Unimplemented bit, read as '0'	
-n = Value at POR	'1' = Bit is set	'0' = Bit is cleared	x = Bit is unknown

- bit 15 **FORCE:** Force DMA Transfer bit⁽¹⁾
 1 = Force a single DMA transfer (Manual mode)
 0 = Automatic DMA transfer initiation by DMA request
- bit 14-7 **Unimplemented:** Read as '0'
- bit 6-0 **IRQSEL<6:0>:** DMA Peripheral IRQ Number Select bits⁽²⁾
 0000000-1111111 = DMAIRQ0-DMAIRQ127 selected to be Channel DMAREQ

- Note 1:** The FORCE bit cannot be cleared by the user. The FORCE bit is cleared by hardware when the forced DMA transfer is complete.
- 2:** Refer to [Table 7-1](#) for a complete listing of IRQ numbers for all interrupt sources.

PIC24HJ32GP302/304, PIC24HJ64GPX02/X04 AND PIC24HJ128GPX02/X04

REGISTER 8-3: DMAxSTA: DMA CHANNEL x RAM START ADDRESS REGISTER A⁽¹⁾

R/W-0	R/W-0	R/W-0	R/W-0	R/W-0	R/W-0	R/W-0	R/W-0
STA<15:8>							
bit 15				bit 8			

R/W-0	R/W-0	R/W-0	R/W-0	R/W-0	R/W-0	R/W-0	R/W-0
STA<7:0>							
bit 7				bit 0			

Legend:

R = Readable bit	W = Writable bit	U = Unimplemented bit, read as '0'
-n = Value at POR	'1' = Bit is set	'0' = Bit is cleared x = Bit is unknown

bit 15-0 **STA<15:0>**: Primary DMA RAM Start Address bits (source or destination)

Note 1: A read of this address register returns the current contents of the DMA RAM Address register, not the contents written to STA<15:0>. If the channel is enabled (i.e., active), writes to this register may result in unpredictable behavior of the DMA channel and should be avoided.

REGISTER 8-4: DMAxSTB: DMA CHANNEL x RAM START ADDRESS REGISTER B⁽¹⁾

R/W-0	R/W-0	R/W-0	R/W-0	R/W-0	R/W-0	R/W-0	R/W-0
STB<15:8>							
bit 15				bit 8			

R/W-0	R/W-0	R/W-0	R/W-0	R/W-0	R/W-0	R/W-0	R/W-0
STB<7:0>							
bit 7				bit 0			

Legend:

R = Readable bit	W = Writable bit	U = Unimplemented bit, read as '0'
-n = Value at POR	'1' = Bit is set	'0' = Bit is cleared x = Bit is unknown

bit 15-0 **STB<15:0>**: Secondary DMA RAM Start Address bits (source or destination)

Note 1: A read of this address register returns the current contents of the DMA RAM Address register, not the contents written to STB<15:0>. If the channel is enabled (i.e., active), writes to this register may result in unpredictable behavior of the DMA channel and should be avoided.

REGISTER 8-5: DMA_xPAD: DMA CHANNEL x PERIPHERAL ADDRESS REGISTER⁽¹⁾

R/W-0	R/W-0	R/W-0	R/W-0	R/W-0	R/W-0	R/W-0	R/W-0
PAD<15:8>							
bit 15							bit 8

R/W-0	R/W-0	R/W-0	R/W-0	R/W-0	R/W-0	R/W-0	R/W-0
PAD<7:0>							
bit 7							bit 0

Legend:
 R = Readable bit W = Writable bit U = Unimplemented bit, read as '0'
 -n = Value at POR '1' = Bit is set '0' = Bit is cleared x = Bit is unknown

bit 15-0 **PAD<15:0>**: Peripheral Address Register bits

Note 1: If the channel is enabled (i.e., active), writes to this register may result in unpredictable behavior of the DMA channel and should be avoided.

REGISTER 8-6: DMA_xCNT: DMA CHANNEL x TRANSFER COUNT REGISTER⁽¹⁾

U-0	U-0	U-0	U-0	U-0	U-0	R/W-0	R/W-0
—	—	—	—	—	—	CNT<9:8> ⁽²⁾	
bit 15							bit 8

R/W-0	R/W-0	R/W-0	R/W-0	R/W-0	R/W-0	R/W-0	R/W-0
CNT<7:0> ⁽²⁾							
bit 7							bit 0

Legend:
 R = Readable bit W = Writable bit U = Unimplemented bit, read as '0'
 -n = Value at POR '1' = Bit is set '0' = Bit is cleared x = Bit is unknown

bit 15-10 **Unimplemented:** Read as '0'
 bit 9-0 **CNT<9:0>**: DMA Transfer Count Register bits⁽²⁾

Note 1: If the channel is enabled (i.e., active), writes to this register may result in unpredictable behavior of the DMA channel and should be avoided.

2: Number of DMA transfers = CNT<9:0> + 1.

PIC24HJ32GP302/304, PIC24HJ64GPX02/X04 AND PIC24HJ128GPX02/X04

REGISTER 8-7: DMACS0: DMA CONTROLLER STATUS REGISTER 0

R/C-0	R/C-0	R/C-0	R/C-0	R/C-0	R/C-0	R/C-0	R/C-0
PWCOL7	PWCOL6	PWCOL5	PWCOL4	PWCOL3	PWCOL2	PWCOL1	PWCOL0
bit 15						bit 8	

R/C-0	R/C-0	R/C-0	R/C-0	R/C-0	R/C-0	R/C-0	R/C-0
XWCOL7	XWCOL6	XWCOL5	XWCOL4	XWCOL3	XWCOL2	XWCOL1	XWCOL0
bit 7						bit 0	

Legend:	C = Clear only bit		
R = Readable bit	W = Writable bit	U = Unimplemented bit, read as '0'	
-n = Value at POR	'1' = Bit is set	'0' = Bit is cleared	x = Bit is unknown

- bit 15 **PWCOL7:** Channel 7 Peripheral Write Collision Flag bit
1 = Write collision detected
0 = No write collision detected
- bit 14 **PWCOL6:** Channel 6 Peripheral Write Collision Flag bit
1 = Write collision detected
0 = No write collision detected
- bit 13 **PWCOL5:** Channel 5 Peripheral Write Collision Flag bit
1 = Write collision detected
0 = No write collision detected
- bit 12 **PWCOL4:** Channel 4 Peripheral Write Collision Flag bit
1 = Write collision detected
0 = No write collision detected
- bit 11 **PWCOL3:** Channel 3 Peripheral Write Collision Flag bit
1 = Write collision detected
0 = No write collision detected
- bit 10 **PWCOL2:** Channel 2 Peripheral Write Collision Flag bit
1 = Write collision detected
0 = No write collision detected
- bit 9 **PWCOL1:** Channel 1 Peripheral Write Collision Flag bit
1 = Write collision detected
0 = No write collision detected
- bit 8 **PWCOL0:** Channel 0 Peripheral Write Collision Flag bit
1 = Write collision detected
0 = No write collision detected
- bit 7 **XWCOL7:** Channel 7 DMA RAM Write Collision Flag bit
1 = Write collision detected
0 = No write collision detected
- bit 6 **XWCOL6:** Channel 6 DMA RAM Write Collision Flag bit
1 = Write collision detected
0 = No write collision detected
- bit 5 **XWCOL5:** Channel 5 DMA RAM Write Collision Flag bit
1 = Write collision detected
0 = No write collision detected
- bit 4 **XWCOL4:** Channel 4 DMA RAM Write Collision Flag bit
1 = Write collision detected
0 = No write collision detected

REGISTER 8-7: DMACS0: DMA CONTROLLER STATUS REGISTER 0 (CONTINUED)

- bit 3 **XWCOL3:** Channel 3 DMA RAM Write Collision Flag bit
 1 = Write collision detected
 0 = No write collision detected
- bit 2 **XWCOL2:** Channel 2 DMA RAM Write Collision Flag bit
 1 = Write collision detected
 0 = No write collision detected
- bit 1 **XWCOL1:** Channel 1 DMA RAM Write Collision Flag bit
 1 = Write collision detected
 0 = No write collision detected
- bit 0 **XWCOL0:** Channel 0 DMA RAM Write Collision Flag bit
 1 = Write collision detected
 0 = No write collision detected

PIC24HJ32GP302/304, PIC24HJ64GPX02/X04 AND PIC24HJ128GPX02/X04

REGISTER 8-8: DMACS1: DMA CONTROLLER STATUS REGISTER 1

U-0	U-0	U-0	U-0	R-1	R-1	R-1	R-1
—	—	—	—	LSTCH<3:0>			
bit 15				bit 8			

R-0	R-0	R-0	R-0	R-0	R-0	R-0	R-0
PPST7	PPST6	PPST5	PPST4	PPST3	PPST2	PPST1	PPST0
bit 7							bit 0

Legend:

R = Readable bit W = Writable bit U = Unimplemented bit, read as '0'
 -n = Value at POR '1' = Bit is set '0' = Bit is cleared x = Bit is unknown

- bit 15-12 **Unimplemented:** Read as '0'
- bit 11-8 **LSTCH<3:0>:** Last DMA Channel Active bits
 - 1111 = No DMA transfer has occurred since system Reset
 - 1110-1000 = Reserved
 - 0111 = Last data transfer was by DMA Channel 7
 - 0110 = Last data transfer was by DMA Channel 6
 - 0101 = Last data transfer was by DMA Channel 5
 - 0100 = Last data transfer was by DMA Channel 4
 - 0011 = Last data transfer was by DMA Channel 3
 - 0010 = Last data transfer was by DMA Channel 2
 - 0001 = Last data transfer was by DMA Channel 1
 - 0000 = Last data transfer was by DMA Channel 0
- bit 7 **PPST7:** Channel 7 Ping-Pong Mode Status Flag bit
 - 1 = DMA7STB register selected
 - 0 = DMA7STA register selected
- bit 6 **PPST6:** Channel 6 Ping-Pong Mode Status Flag bit
 - 1 = DMA6STB register selected
 - 0 = DMA6STA register selected
- bit 5 **PPST5:** Channel 5 Ping-Pong Mode Status Flag bit
 - 1 = DMA5STB register selected
 - 0 = DMA5STA register selected
- bit 4 **PPST4:** Channel 4 Ping-Pong Mode Status Flag bit
 - 1 = DMA4STB register selected
 - 0 = DMA4STA register selected
- bit 3 **PPST3:** Channel 3 Ping-Pong Mode Status Flag bit
 - 1 = DMA3STB register selected
 - 0 = DMA3STA register selected
- bit 2 **PPST2:** Channel 2 Ping-Pong Mode Status Flag bit
 - 1 = DMA2STB register selected
 - 0 = DMA2STA register selected
- bit 1 **PPST1:** Channel 1 Ping-Pong Mode Status Flag bit
 - 1 = DMA1STB register selected
 - 0 = DMA1STA register selected
- bit 0 **PPST0:** Channel 0 Ping-Pong Mode Status Flag bit
 - 1 = DMA0STB register selected
 - 0 = DMA0STA register selected

REGISTER 8-9: DSADR: MOST RECENT DMA RAM ADDRESS

R-0	R-0	R-0	R-0	R-0	R-0	R-0	R-0
DSADR<15:8>							
bit 15				bit 8			

R-0	R-0	R-0	R-0	R-0	R-0	R-0	R-0
DSADR<7:0>							
bit 7				bit 0			

Legend:							
R = Readable bit	W = Writable bit	U = Unimplemented bit, read as '0'					
-n = Value at POR	'1' = Bit is set	'0' = Bit is cleared	x = Bit is unknown				

bit 15-0 **DSADR<15:0>**: Most Recent DMA RAM Address Accessed by DMA Controller bits

NOTES:

9.0 OSCILLATOR CONFIGURATION

Note 1: This data sheet summarizes the features of the PIC24HJ32GP302/304, PIC24HJ64GPX02/X04 and PIC24HJ128GPX02/X04 families of devices. It is not intended to be a comprehensive reference source. To complement the information in this data sheet, refer to **Section 39. "Oscillator (Part III)"** (DS70216) of the "dsPIC33F/PIC24H Family Reference Manual", which is available from the Microchip web site (www.microchip.com).

2: Some registers and associated bits described in this section may not be available on all devices. Refer to **Section 4.0 "Memory Organization"** in this data sheet for device-specific register and bit information.

The PIC24HJ32GP302/304, PIC24HJ64GPX02/X04 and PIC24HJ128GPX02/X04 oscillator system provides:

- External and internal oscillator options as clock sources
- An on-chip Phase-Locked Loop (PLL) to scale the internal operating frequency to the required system clock frequency
- An internal FRC oscillator that can also be used with the PLL, thereby allowing full-speed operation without any external clock generation hardware
- Clock switching between various clock sources
- Programmable clock postscaler for system power savings
- A Fail-Safe Clock Monitor (FSCM) that detects clock failure and takes fail-safe measures
- An Oscillator Control register (OSCCON)
- Nonvolatile Configuration bits for main oscillator selection.

A simplified diagram of the oscillator system is shown in **Figure 9-1**.

FIGURE 9-1: OSCILLATOR SYSTEM DIAGRAM



9.1 CPU Clocking System

The PIC24HJ32GP302/304, PIC24HJ64GPX02/X04 and PIC24HJ128GPX02/X04 devices provide seven system clock options:

- Fast RC (FRC) Oscillator
- FRC Oscillator with Phase-Locked Loop (PLL)
- Primary (XT, HS or EC) Oscillator
- Primary Oscillator with PLL
- Secondary (LP) Oscillator
- Low-Power RC (LPRC) Oscillator
- FRC Oscillator with postscaler

9.1.1 SYSTEM CLOCK SOURCES

The Fast RC (FRC) internal oscillator runs at a nominal frequency of 7.37 MHz. User software can tune the FRC frequency. User software can optionally specify a factor (ranging from 1:2 to 1:256) by which the FRC clock frequency is divided. This factor is selected using the $FRCDIV<2:0>$ ($CLKDIV<10:8>$) bits.

The primary oscillator can use one of the following as its clock source:

- Crystal (XT): Crystals and ceramic resonators in the range of 3 MHz to 10 MHz. The crystal is connected to the OSC1 and OSC2 pins.
- High-Speed Crystal (HS): Crystals in the range of 10 MHz to 40 MHz. The crystal is connected to the OSC1 and OSC2 pins.
- External Clock (EC): External clock signal is directly applied to the OSC1 pin.

The secondary (LP) oscillator is designed for low power and uses a 32.768 kHz crystal or ceramic resonator. The LP oscillator uses the SOSCI and SOSCO pins.

The Low-Power RC (LPRC) internal oscillator runs at a nominal frequency of 32.768 kHz. It is also used as a reference clock by the Watchdog Timer (WDT) and Fail-Safe Clock Monitor (FSCM).

The clock signals generated by the FRC and primary oscillators can be optionally applied to an on-chip PLL to provide a wide range of output frequencies for device operation. PLL configuration is described in [Section 9.1.3 “PLL Configuration”](#).

The FRC frequency depends on the FRC accuracy (see [Table 28-19](#)) and the value of the FRC Oscillator Tuning register (see [Register 9-4](#)).

9.1.2 SYSTEM CLOCK SELECTION

The oscillator source used at a device Power-on Reset event is selected using Configuration bit settings. The oscillator Configuration bit settings are located in the Configuration registers in the program memory. (Refer to [Section 25.1 “Configuration Bits”](#) for further details.) The Initial Oscillator Selection Configuration bits, $FNOSC<2:0>$ ($FOSCSEL<2:0>$), and the Primary Oscillator Mode Select Configuration bits, $POSCMD<1:0>$ ($FOSC<1:0>$), select the oscillator source that is used at a Power-on Reset. The FRC primary oscillator is the default (unprogrammed) selection.

The Configuration bits allow users to choose among 12 different clock modes, shown in [Table 9-1](#).

The output of the oscillator (or the output of the PLL if a PLL mode has been selected) $FOSC$ is divided by 2 to generate the device instruction clock (FCY) and the peripheral clock time base (FP). FCY defines the operating speed of the device, and speeds up to 40 MHz are supported by the PIC24HJ32GP302/304, PIC24HJ64GPX02/X04 and PIC24HJ128GPX02/X04 architecture.

Instruction execution speed or device operating frequency, FCY , is given by:

EQUATION 9-1: DEVICE OPERATING FREQUENCY

$$FCY = \frac{FOSC}{2}$$

9.1.3 PLL CONFIGURATION

The primary oscillator and internal FRC oscillator can optionally use an on-chip PLL to obtain higher speeds of operation. The PLL provides significant flexibility in selecting the device operating speed. A block diagram of the PLL is shown in Figure 9-2.

The output of the primary oscillator or FRC, denoted as 'FIN', is divided down by a prescale factor (N1) of 2, 3, ... or 33 before being provided to the PLL's Voltage Controlled Oscillator (VCO). The input to the VCO must be selected in the range of 0.8 MHz to 8 MHz. The prescale factor 'N1' is selected using the PLLPRE<4:0> bits (CLKDIV<4:0>).

The PLL Feedback Divisor, selected using the PLLDIV<8:0> bits (PLLFBD<8:0>), provides a factor 'M', by which the input to the VCO is multiplied. This factor must be selected such that the resulting VCO output frequency is in the range of 100 MHz to 200 MHz.

The VCO output is further divided by a postscale factor 'N2'. This factor is selected using the PLLPOST<1:0> bits (CLKDIV<7:6>). 'N2' can be either 2, 4 or 8, and must be selected such that the PLL output frequency (Fosc) is in the range of 12.5 MHz to 80 MHz, which generates device operating speeds of 6.25-40 MIPS.

For a primary oscillator or FRC oscillator, output 'FIN', the PLL output 'Fosc' is given by:

EQUATION 9-2: Fosc CALCULATION

$$F_{OSC} = F_{IN} \cdot \left(\frac{M}{N1 \cdot N2} \right)$$

For example, suppose a 10 MHz crystal is being used with the selected oscillator mode of XT with PLL.

- If PLLPRE<4:0> = 0, then N1 = 2. This yields a VCO input of 10/2 = 5 MHz, which is within the acceptable range of 0.8-8 MHz.
- If PLLDIV<8:0> = 0x1E, then M = 32. This yields a VCO output of 5 x 32 = 160 MHz, which is within the 100-200 MHz ranged needed.
- If PLLPOST<1:0> = 0, then N2 = 2. This provides a Fosc of 160/2 = 80 MHz. The resultant device operating speed is 80/2 = 40 MIPS.

EQUATION 9-3: XT WITH PLL MODE EXAMPLE

$$F_{CY} = \frac{F_{OSC}}{2} = \frac{1}{2} \left(\frac{10000000 \cdot 32}{2 \cdot 2} \right) = 40 \text{ MIPS}$$

FIGURE 9-2: PIC24HJ32GP302/304, PIC24HJ64GPX02/X04 AND PIC24HJ128GPX02/X04 PLL BLOCK DIAGRAM



TABLE 9-1: CONFIGURATION BIT VALUES FOR CLOCK SELECTION

Oscillator Mode	Oscillator Source	POSCMD<1:0>	FNOSC<2:0>	See Note
Fast RC Oscillator with Divide-by-N (FRCDIVN)	Internal	xx	111	1, 2
Fast RC Oscillator with Divide-by-16 (FRCDIV16)	Internal	xx	110	1
Low-Power RC Oscillator (LPRC)	Internal	xx	101	1
Secondary (Timer1) Oscillator (SOSC)	Secondary	xx	100	1
Primary Oscillator (HS) with PLL (HSPLL)	Primary	10	011	—
Primary Oscillator (XT) with PLL (XTPLL)	Primary	01	011	—
Primary Oscillator (EC) with PLL (ECPLL)	Primary	00	011	1
Primary Oscillator (HS)	Primary	10	010	—
Primary Oscillator (XT)	Primary	01	010	—
Primary Oscillator (EC)	Primary	00	010	1
Fast RC Oscillator with PLL (FRCPLL)	Internal	xx	001	1
Fast RC Oscillator (FRC)	Internal	xx	000	1

Note 1: OSC2 pin function is determined by the OSCIOFNC Configuration bit.
2: This is the default oscillator mode for an unprogrammed (erased) device.

9.2 Oscillator Resources

Many useful resources related to Oscillators are provided on the main product page of the Microchip web site for the devices listed in this data sheet. This product page, which can be accessed using this [link](#), contains the latest updates and additional information.

Note: In the event you are not able to access the product page using the link above, enter this URL in your browser:
<http://www.microchip.com/wwwproducts/Devices.aspx?dDocName=en532315>

9.2.1 KEY RESOURCES

- **Section 39. “Oscillator (Part III)”** (DS70216)
- Code Samples
- Application Notes
- Software Libraries
- Webinars
- All related dsPIC33F/PIC24H Family Reference Manuals Sections
- Development Tools

9.3 Oscillator Control Registers

REGISTER 9-1: OSCCON: OSCILLATOR CONTROL REGISTER^(1,3)

U-0	R-0	R-0	R-0	U-0	R/W-y	R/W-y	R/W-y
—	COSC<2:0>			—	NOSC<2:0> ⁽²⁾		
bit 15				bit 8			

R/W-0	R/W-0	R-0	U-0	R/C-0	U-0	R/W-0	R/W-0
CLKLOCK	IOLOCK	LOCK	—	CF	—	LPOSCEN	OSWEN
bit 7						bit 0	

Legend:	y = Value set from Configuration bits on POR	C = Clear only bit
R = Readable bit	W = Writable bit	U = Unimplemented bit, read as '0'
-n = Value at POR	'1' = Bit is set	'0' = Bit is cleared
		x = Bit is unknown

bit 15 **Unimplemented:** Read as '0'

bit 14-12 **COSC<2:0>:** Current Oscillator Selection bits (read-only)

- 111 = Fast RC oscillator (FRC) with Divide-by-n
- 110 = Fast RC oscillator (FRC) with Divide-by-16
- 101 = Low-Power RC oscillator (LPRC)
- 100 = Secondary oscillator (Sosc)
- 011 = Primary oscillator (XT, HS, EC) with PLL
- 010 = Primary oscillator (XT, HS, EC)
- 001 = Fast RC Oscillator (FRC) with divide-by-N and PLL (FRCDIVN + PLL)
- 000 = Fast RC oscillator (FRC)

bit 11 **Unimplemented:** Read as '0'

bit 10-8 **NOSC<2:0>:** New Oscillator Selection bits⁽²⁾

- 111 = Fast RC oscillator (FRC) with Divide-by-n
- 110 = Fast RC oscillator (FRC) with Divide-by-16
- 101 = Low-Power RC oscillator (LPRC)
- 100 = Secondary oscillator (Sosc)
- 011 = Primary oscillator (XT, HS, EC) with PLL
- 010 = Primary oscillator (XT, HS, EC)
- 001 = Fast RC Oscillator (FRC) with divide-by-N and PLL (FRCDIVN + PLL)
- 000 = Fast RC oscillator (FRC)

bit 7 **CLKLOCK:** Clock Lock Enable bit

If clock switching is enabled and FSCM is disabled, FCKSM<1:0>(FOSC<7:6>) = 0b01

- 1 = Clock switching is disabled, system clock source is locked
- 0 = Clock switching is enabled, system clock source can be modified by clock switching

bit 6 **IOLOCK:** Peripheral Pin Select Lock bit

- 1 = Peripheral pin select is locked, write to peripheral pin select registers not allowed
- 0 = Peripheral pin select is not locked, write to peripheral pin select registers allowed

bit 5 **LOCK:** PLL Lock Status bit (read-only)

- 1 = Indicates that PLL is in lock, or PLL start-up timer is satisfied
- 0 = Indicates that PLL is out of lock, start-up timer is in progress or PLL is disabled

bit 4 **Unimplemented:** Read as '0'

Note 1: Writes to this register require an unlock sequence. Refer to **Section 39. "Oscillator (Part III)"** (DS70308) in the *dsPIC33F/PIC24H Family Reference Manual* (available from the Microchip web site) for details.

2: Direct clock switches between any primary oscillator mode with PLL and FRCPLL mode are not permitted. This applies to clock switches in either direction. In these instances, the application must switch to FRC mode as a transition clock source between the two PLL modes.

3: This register is reset only on a Power-on Reset (POR).

REGISTER 9-1: OSCCON: OSCILLATOR CONTROL REGISTER^(1,3) (CONTINUED)

- bit 3 **CF:** Clock Fail Detect bit (read/clear by application)
 1 = FSCM has detected clock failure
 0 = FSCM has not detected clock failure
- bit 2 **Unimplemented:** Read as '0'
- bit 1 **LPOSCEN:** Secondary (LP) Oscillator Enable bit
 1 = Enable secondary oscillator
 0 = Disable secondary oscillator
- bit 0 **OSWEN:** Oscillator Switch Enable bit
 1 = Request oscillator switch to selection specified by NOSC<2:0> bits
 0 = Oscillator switch is complete

- Note 1:** Writes to this register require an unlock sequence. Refer to **Section 39. "Oscillator (Part III)"** (DS70308) in the *"dsPIC33F/PIC24H Family Reference Manual"* (available from the Microchip web site) for details.
- 2:** Direct clock switches between any primary oscillator mode with PLL and FRCPLL mode are not permitted. This applies to clock switches in either direction. In these instances, the application must switch to FRC mode as a transition clock source between the two PLL modes.
- 3:** This register is reset only on a Power-on Reset (POR).

REGISTER 9-2: CLKDIV: CLOCK DIVISOR REGISTER⁽²⁾

R/W-0	R/W-0	R/W-1	R/W-1	R/W-0	R/W-0	R/W-0	R/W-0
ROI	DOZE<2:0>			DOZEN ⁽¹⁾	FRCDIV<2:0>		
bit 15							bit 8

R/W-0	R/W-1	U-0	R/W-0	R/W-0	R/W-0	R/W-0	R/W-0
PLLPOST<1:0>		—	PLLPRE<4:0>				
bit 7							bit 0

Legend:	y = Value set from Configuration bits on POR		
R = Readable bit	W = Writable bit	U = Unimplemented bit, read as '0'	
-n = Value at POR	'1' = Bit is set	'0' = Bit is cleared	x = Bit is unknown

- bit 15 **ROI:** Recover on Interrupt bit
 1 = Interrupts clears the DOZEN bit and the processor clock/peripheral clock ratio is set to 1:1
 0 = Interrupts have no effect on the DOZEN bit

- bit 14-12 **DOZE<2:0>:** Processor Clock Reduction Select bits
 111 = Fcy/128
 110 = Fcy/64
 101 = Fcy/32
 100 = Fcy/16
 011 = Fcy/8 (default)
 010 = Fcy/4
 001 = Fcy/2
 000 = Fcy/1

- bit 11 **DOZEN:** DOZE Mode Enable bit⁽¹⁾
 1 = The DOZE<2:0> bits specify the ratio between the peripheral clocks and the processor clocks
 0 = Processor clock/peripheral clock ratio forced to 1:1

- bit 10-8 **FRCDIV<2:0>:** Internal Fast RC Oscillator Postscaler bits
 111 = FRC divide by 256
 110 = FRC divide by 64
 101 = FRC divide by 32
 100 = FRC divide by 16
 011 = FRC divide by 8
 010 = FRC divide by 4
 001 = FRC divide by 2
 000 = FRC divide by 1 (default)

- bit 7-6 **PLLPOST<1:0>:** PLL VCO Output Divider Select bits (also denoted as 'N2', PLL postscaler)
 11 = Output/8
 10 = Reserved
 01 = Output/4 (default)
 00 = Output/2

- bit 5 **Unimplemented:** Read as '0'

- bit 4-0 **PLLPRE<4:0>:** PLL Phase Detector Input Divider bits (also denoted as 'N1', PLL prescaler)
 11111 = Input/33
 •
 •
 •
 00001 = Input/3
 00000 = Input/2 (default)

- Note 1:** This bit is cleared when the ROI bit is set and an interrupt occurs.
- 2:** This register is reset only on a Power-on Reset (POR).

PIC24HJ32GP302/304, PIC24HJ64GPX02/X04 AND PIC24HJ128GPX02/X04

REGISTER 9-3: PLLFBD: PLL FEEDBACK DIVISOR REGISTER⁽¹⁾

U-0	U-0	U-0	U-0	U-0	U-0	U-0	R/W-0
—	—	—	—	—	—	—	PLLDIV<8>
bit 15							bit 8

R/W-0	R/W-0	R/W-1	R/W-1	R/W-0	R/W-0	R/W-0	R/W-0
PLLDIV<7:0>							
bit 7							bit 0

Legend:

R = Readable bit W = Writable bit U = Unimplemented bit, read as '0'
 -n = Value at POR '1' = Bit is set '0' = Bit is cleared x = Bit is unknown

bit 15-9 **Unimplemented:** Read as '0'
 bit 8-0 **PLLDIV<8:0>:** PLL Feedback Divisor bits (also denoted as 'M', PLL multiplier)
 111111111 = 513
 •
 •
 •
 000110000 = 50 (default)
 •
 •
 •
 000000010 = 4
 000000001 = 3
 000000000 = 2

Note 1: This register is reset only on a Power-on Reset (POR).

REGISTER 9-4: OSCTUN: FRC OSCILLATOR TUNING REGISTER⁽²⁾

U-0	U-0	U-0	U-0	U-0	U-0	U-0	U-0
—	—	—	—	—	—	—	—
bit 15							bit 8

U-0	U-0	R/W-0	R/W-0	R/W-0	R/W-0	R/W-0	R/W-0
—	—	TUN<5:0> ⁽¹⁾					
bit 7							bit 0

Legend:			
R = Readable bit	W = Writable bit	U = Unimplemented bit, read as '0'	
-n = Value at POR	'1' = Bit is set	'0' = Bit is cleared	x = Bit is unknown

- bit 15-6 **Unimplemented:** Read as '0'
- bit 5-0 **TUN<5:0>:** FRC Oscillator Tuning bits⁽¹⁾
- 111111 = Center frequency -0.375% (7.345 MHz)
- .
- .
- .
- 100001 = Center frequency -11.625% (6.52 MHz)
- 100000 = Center frequency -12% (6.49 MHz)
- 011111 = Center frequency +11.625% (8.23 MHz)
- 011110 = Center frequency +11.25% (8.20 MHz)
- .
- .
- .
- 000001 = Center frequency +0.375% (7.40 MHz)
- 000000 = Center frequency (7.37 MHz nominal)

- Note 1:** OSCTUN functionality has been provided to help customers compensate for temperature effects on the FRC frequency over a wide range of temperatures. The tuning step size is an approximation and is neither characterized nor tested.
- 2:** This register is reset only on a Power-on Reset (POR).

9.4 Clock Switching Operation

Applications are free to switch among any of the four clock sources (Primary, LP, FRC and LPRC) under software control at any time. To limit the possible side effects of this flexibility, PIC24HJ32GP302/304, PIC24HJ64GPX02/X04 and PIC24HJ128GPX02/X04 devices have a safeguard lock built into the switch process.

Note: Primary Oscillator mode has three different submodes (XT, HS and EC), which are determined by the POSCMD<1:0> Configuration bits. While an application can switch to and from Primary Oscillator mode in software, it cannot switch among the different primary submodes without reprogramming the device.

9.4.1 ENABLING CLOCK SWITCHING

To enable clock switching, the FCKSM1 Configuration bit in the Configuration register must be programmed to '0'. (Refer to [Section 25.1 "Configuration Bits"](#) for further details.) If the FCKSM1 Configuration bit is unprogrammed ('1'), the clock switching function and FSCM function are disabled. This is the default setting.

The NOSC<2:0> control bits (OSCCON<10:8>) do not control the clock selection when clock switching is disabled. However, the COSC<2:0> bits (OSCCON<14:12>) reflect the clock source selected by the FNOSEC<2:0> Configuration bits FOSCSSEL<2:0>.

The OSWEN control bit (OSCCON<0>) has no effect when clock switching is disabled. It is held at '0' at all times.

9.4.2 OSCILLATOR SWITCHING SEQUENCE

Performing a clock switch requires this basic sequence:

1. If required, read the COSC<2:0> bits to determine the current oscillator source.
2. Perform the unlock sequence to allow a write to the OSCCON register high byte.
3. Write the appropriate value to the NOSC<2:0> control bits for the new oscillator source.
4. Perform the unlock sequence to allow a write to the OSCCON register low byte.
5. Set the OSWEN bit to initiate the oscillator switch.

After the basic sequence is completed, the system clock hardware responds automatically as follows:

1. The clock switching hardware compares the COSC<2:0> status bits with the new value of the NOSC<2:0> control bits. If they are the same, the clock switch is a redundant operation. In this case, the OSWEN bit is cleared automatically and the clock switch is aborted.
2. If a valid clock switch has been initiated, the LOCK (OSCCON<5>) and the CF

(OSCCON<3>) status bits are cleared.

3. The new oscillator is turned on by the hardware if it is not currently running. If a crystal oscillator must be turned on, the hardware waits until the Oscillator Start-up Timer (OST) expires. If the new source is using the PLL, the hardware waits until a PLL lock is detected (LOCK = 1).
4. The hardware waits for 10 clock cycles from the new clock source and then performs the clock switch.
5. The hardware clears the OSWEN bit to indicate a successful clock transition. In addition, the NOSC bit values are transferred to the COSC<2:0> status bits.
6. The old clock source is turned off at this time, with the exception of LPRC (if WDT or FSCM are enabled) or LP (if LPOSCEN remains set).

Note 1: The processor continues to execute code throughout the clock switching sequence. Timing-sensitive code should not be executed during this time.

2: Direct clock switches between any primary oscillator mode with PLL and FRCPLL mode are not permitted. This applies to clock switches in either direction. In these instances, the application must switch to FRC mode as a transition clock source between the two PLL modes.

3: Refer to [Section 39. "Oscillator \(Part III\)"](#) (DS70308) in the *"dsPIC33F/PIC24H Family Reference Manual"* for details.

9.5 Fail-Safe Clock Monitor (FSCM)

The Fail-Safe Clock Monitor (FSCM) allows the device to continue to operate even in the event of an oscillator failure. The FSCM function is enabled by programming. If the FSCM function is enabled, the LPRC internal oscillator runs at all times (except during Sleep mode) and is not subject to control by the Watchdog Timer.

If an oscillator fails, the FSCM generates a clock failure trap event and switches the system clock over to the FRC oscillator. Then the application program can either attempt to restart the oscillator or execute a controlled shutdown. The trap can be treated as a warm Reset by simply loading the Reset address into the oscillator fail trap vector.

If the PLL multiplier is used to scale the system clock, the internal FRC is also multiplied by the same factor on clock failure. Essentially, the device switches to FRC with PLL on a clock failure.

10.0 POWER-SAVING FEATURES

Note 1: This data sheet summarizes the features of the PIC24HJ32GP302/304, PIC24HJ64GPX02/X04 and PIC24HJ128GPX02/X04 families of devices. It is not intended to be a comprehensive reference source. To complement the information in this data sheet, refer to **Section 9. “Watchdog Timer and Power-Saving Modes”** (DS70196) of the “dsPIC33F/PIC24H Family Reference Manual”, which is available from the Microchip web site (www.microchip.com).

2: Some registers and associated bits described in this section may not be available on all devices. Refer to **Section 4.0 “Memory Organization”** in this data sheet for device-specific register and bit information.

The PIC24HJ32GP302/304, PIC24HJ64GPX02/X04 and PIC24HJ128GPX02/X04 devices provide the ability to manage power consumption by selectively managing clocking to the CPU and the peripherals. In general, a lower clock frequency and a reduction in the number of circuits being clocked constitutes lower consumed power. PIC24HJ32GP302/304, PIC24HJ64GPX02/X04 and PIC24HJ128GPX02/X04 devices can manage power consumption in four ways:

- Clock frequency
- Instruction-based Sleep and Idle modes
- Software-controlled Doze mode
- Selective peripheral control in software

Combinations of these methods can be used to selectively tailor an application’s power consumption while still maintaining critical application features, such as timing-sensitive communications.

10.1 Clock Frequency and Clock Switching

PIC24HJ32GP302/304, PIC24HJ64GPX02/X04 and PIC24HJ128GPX02/X04 devices allow a wide range of clock frequencies to be selected under application control. If the system clock configuration is not locked, users can choose low-power or high-precision oscillators by simply changing the NOSC bits (OSCCON<10:8>). The process of changing a system clock during operation, as well as limitations to the process, are discussed in more detail in **Section 9.0 “Oscillator Configuration”**.

EXAMPLE 10-1: PWRSAV INSTRUCTION SYNTAX

```
PWRSAV #SLEEP_MODE    ; Put the device into SLEEP mode
PWRSAV #IDLE_MODE     ; Put the device into IDLE mode
```

10.2 Instruction-Based Power-Saving Modes

PIC24HJ32GP302/304, PIC24HJ64GPX02/X04 and PIC24HJ128GPX02/X04 devices have two special power-saving modes that are entered through the execution of a special PWRSAV instruction. Sleep mode stops clock operation and halts all code execution. Idle mode halts the CPU and code execution, but allows peripheral modules to continue operation. The assembler syntax of the PWRSAV instruction is shown in **Example 10-1**.

Note: SLEEP_MODE and IDLE_MODE are constants defined in the assembler include file for the selected device.

Sleep and Idle modes can be exited as a result of an enabled interrupt, WDT time-out or a device Reset. When the device exits these modes, it is said to wake up.

10.2.1 SLEEP MODE

The following occur in Sleep mode:

- The system clock source is shut down. If an on-chip oscillator is used, it is turned off.
- The device current consumption is reduced to a minimum, provided that no I/O pin is sourcing current.
- The Fail-Safe Clock Monitor does not operate, since the system clock source is disabled.
- The LPRC clock continues to run in Sleep mode if the WDT is enabled.
- The WDT, if enabled, is automatically cleared prior to entering Sleep mode.
- Some device features or peripherals can continue to operate. This includes items such as the input change notification on the I/O ports, or peripherals that use an external clock input.
- Any peripheral that requires the system clock source for its operation is disabled.

The device wakes up from Sleep mode on any of the these events:

- Any interrupt source that is individually enabled
- Any form of device Reset
- A WDT time-out

On wake-up from Sleep mode, the processor restarts with the same clock source that was active when Sleep mode was entered.

10.2.2 IDLE MODE

The following occur in Idle mode:

- The CPU stops executing instructions.
- The WDT is automatically cleared.
- The system clock source remains active. By default, all peripheral modules continue to operate normally from the system clock source, but can also be selectively disabled (see [Section 10.4 “Peripheral Module Disable”](#)).
- If the WDT or FSCM is enabled, the LPRC also remains active.

The device wakes from Idle mode on any of these events:

- Any interrupt that is individually enabled
- Any device Reset
- A WDT time-out

On wake-up from Idle mode, the clock is reapplied to the CPU and instruction execution will begin (2 to 4 cycles later), starting with the instruction following the `PWRSAV` instruction, or the first instruction in the ISR.

10.2.3 INTERRUPTS COINCIDENT WITH POWER SAVE INSTRUCTIONS

Any interrupt that coincides with the execution of a `PWRSAV` instruction is held off until entry into Sleep or Idle mode has completed. The device then wakes up from Sleep or Idle mode.

10.3 Doze Mode

The preferred strategies for reducing power consumption are changing clock speed and invoking one of the power-saving modes. In some circumstances, this cannot be practical. For example, it may be necessary for an application to maintain uninterrupted synchronous communication, even while it is doing nothing else. Reducing system clock speed can introduce communication errors, while using a power-saving mode can stop communications completely.

Doze mode is a simple and effective alternative method to reduce power consumption while the device is still executing code. In this mode, the system clock continues to operate from the same source and at the same speed. Peripheral modules continue to be clocked at the same speed, while the CPU clock speed is reduced. Synchronization between the two clock domains is maintained, allowing the peripherals to access the SFRs while the CPU executes code at a slower rate.

Doze mode is enabled by setting the DOZEN bit (`CLKDIV<11>`). The ratio between peripheral and core clock speed is determined by the `DOZE<2:0>` bits (`CLKDIV<14:12>`). There are eight possible configurations, from 1:1 to 1:128, with 1:1 being the default setting.

Programs can use Doze mode to selectively reduce power consumption in event-driven applications. This allows clock-sensitive functions, such as synchronous communications, to continue without interruption while the CPU idles, waiting for something to invoke an interrupt routine. An automatic return to full-speed CPU operation on interrupts can be enabled by setting the ROI bit (`CLKDIV<15>`). By default, interrupt events have no effect on Doze mode operation.

For example, suppose the device is operating at 20 MIPS and the ECAN module has been configured for 500 kbps based on this device operating speed. If the device is placed in Doze mode with a clock frequency ratio of 1:4, the ECAN module continues to communicate at the required bit rate of 500 kbps, but the CPU now starts executing instructions at a frequency of 5 MIPS.

10.4 Peripheral Module Disable

The Peripheral Module Disable (PMD) registers provide a method to disable a peripheral module by stopping all clock sources supplied to that module. When a peripheral is disabled using the appropriate PMD control bit, the peripheral is in a minimum power consumption state. The control and status registers associated with the peripheral are also disabled, so writes to those registers do not have effect and read values are invalid.

A peripheral module is enabled only if both the associated bit in the PMD register is cleared and the peripheral is supported by the specific PIC MCU variant. If the peripheral is present in the device, it is enabled in the PMD register by default.

Note: If a PMD bit is set, the corresponding module is disabled after a delay of one instruction cycle. Similarly, if a PMD bit is cleared, the corresponding module is enabled after a delay of one instruction cycle (assuming the module control registers are already configured to enable module operation).

10.5 Power-Saving Resources

Many useful resources related to power-saving modes are provided on the main product page of the Microchip web site for the devices listed in this data sheet. This product page, which can be accessed using this [link](#), contains the latest updates and additional information.

<p>Note: In the event you are not able to access the product page using the link above, enter this URL in your browser: http://www.microchip.com/wwwproducts/Devices.aspx?dDocName=en532315</p>
--

10.5.1 KEY RESOURCES

- **Section 9. “Watchdog Timer and Power-Saving Modes”** (DS70196)
- Code Samples
- Application Notes
- Software Libraries
- Webinars
- All related dsPIC33F/PIC24H Family Reference Manuals Sections
- Development Tools

10.6 Power-Saving Control Registers

REGISTER 10-1: PMD1: PERIPHERAL MODULE DISABLE CONTROL REGISTER 1

R/W-0	R/W-0	R/W-0	R/W-0	R/W-0	U-0	U-0	U-0
T5MD	T4MD	T3MD	T2MD	T1MD	—	—	—
bit 15							bit 8

R/W-0	R/W-0	R/W-0	R/W-0	R/W-0	U-0	R/W-0	R/W-0
I2C1MD	U2MD	U1MD	SPI2MD	SPI1MD	—	C1MD	AD1MD
bit 7							bit 0

Legend:							
R = Readable bit	W = Writable bit	U = Unimplemented bit, read as '0'					
-n = Value at POR	'1' = Bit is set	'0' = Bit is cleared	x = Bit is unknown				

bit 15 **T5MD:** Timer5 Module Disable bit
 1 = Timer5 module is disabled
 0 = Timer5 module is enabled

bit 14 **T4MD:** Timer4 Module Disable bit
 1 = Timer4 module is disabled
 0 = Timer4 module is enabled

bit 13 **T3MD:** Timer3 Module Disable bit
 1 = Timer3 module is disabled
 0 = Timer3 module is enabled

bit 12 **T2MD:** Timer2 Module Disable bit
 1 = Timer2 module is disabled
 0 = Timer2 module is enabled

bit 11 **T1MD:** Timer1 Module Disable bit
 1 = Timer1 module is disabled
 0 = Timer1 module is enabled

bit 10-8 **Unimplemented:** Read as '0'

bit 7 **I2C1MD:** I²C1 Module Disable bit
 1 = I²C1 module is disabled
 0 = I²C1 module is enabled

bit 6 **U2MD:** UART2 Module Disable bit
 1 = UART2 module is disabled
 0 = UART2 module is enabled

bit 5 **U1MD:** UART1 Module Disable bit
 1 = UART1 module is disabled
 0 = UART1 module is enabled

bit 4 **SPI2MD:** SPI2 Module Disable bit
 1 = SPI2 module is disabled
 0 = SPI2 module is enabled

bit 3 **SPI1MD:** SPI1 Module Disable bit
 1 = SPI1 module is disabled
 0 = SPI1 module is enabled

bit 2 **Unimplemented:** Read as '0'

bit 1 **C1MD:** ECAN1 Module Disable bit
 1 = ECAN1 module is disabled
 0 = ECAN1 module is enabled

bit 0 **AD1MD:** ADC1 Module Disable bit
 1 = ADC1 module is disabled
 0 = ADC1 module is enabled

REGISTER 10-2: PMD2: PERIPHERAL MODULE DISABLE CONTROL REGISTER 2

R/W-0	R/W-0	U-0	U-0	U-0	U-0	R/W-0	R/W-0
IC8MD	IC7MD	—	—	—	—	IC2MD	IC1MD
bit 15							bit 8

U-0	U-0	U-0	U-0	R/W-0	R/W-0	R/W-0	R/W-0
—	—	—	—	OC4MD	OC3MD	OC2MD	OC1MD
bit 7							bit 0

Legend:			
R = Readable bit	W = Writable bit	U = Unimplemented bit, read as '0'	
-n = Value at POR	'1' = Bit is set	'0' = Bit is cleared	x = Bit is unknown

- bit 15 **IC8MD:** Input Capture 8 Module Disable bit
 1 = Input Capture 8 module is disabled
 0 = Input Capture 8 module is enabled
- bit 14 **IC7MD:** Input Capture 2 Module Disable bit
 1 = Input Capture 7 module is disabled
 0 = Input Capture 7 module is enabled
- bit 13-10 **Unimplemented:** Read as '0'
- bit 9 **IC2MD:** Input Capture 2 Module Disable bit
 1 = Input Capture 2 module is disabled
 0 = Input Capture 2 module is enabled
- bit 8 **IC1MD:** Input Capture 1 Module Disable bit
 1 = Input Capture 1 module is disabled
 0 = Input Capture 1 module is enabled
- bit 7-4 **Unimplemented:** Read as '0'
- bit 3 **OC4MD:** Output Compare 4 Module Disable bit
 1 = Output Compare 4 module is disabled
 0 = Output Compare 4 module is enabled
- bit 2 **OC3MD:** Output Compare 3 Module Disable bit
 1 = Output Compare 3 module is disabled
 0 = Output Compare 3 module is enabled
- bit 1 **OC2MD:** Output Compare 2 Module Disable bit
 1 = Output Compare 2 module is disabled
 0 = Output Compare 2 module is enabled
- bit 0 **OC1MD:** Output Compare 1 Module Disable bit
 1 = Output Compare 1 module is disabled
 0 = Output Compare 1 module is enabled

PIC24HJ32GP302/304, PIC24HJ64GPX02/X04 AND PIC24HJ128GPX02/X04

REGISTER 10-3: PMD3: PERIPHERAL MODULE DISABLE CONTROL REGISTER 3

U-0	U-0	U-0	U-0	U-0	R/W-0	R/W-0	R/W-0
—	—	—	—	—	CMPMD	RTCCMD	PMPMD
bit 15						bit 8	

R/W-0	R/W-0	U-0	U-0	U-0	U-0	U-0	U-0
CRCMD	DAC1MD	—	—	—	—	—	—
bit 7						bit 0	

Legend:

R = Readable bit

W = Writable bit

U = Unimplemented bit, read as '0'

-n = Value at POR

'1' = Bit is set

'0' = Bit is cleared

x = Bit is unknown

- bit 15-11 **Unimplemented:** Read as '0'
- bit 10 **CMPMD:** Comparator Module Disable bit
 1 = Comparator module is disabled
 0 = Comparator module is enabled
- bit 9 **RTCCMD:** RTCC Module Disable bit
 1 = RTCC module is disabled
 0 = RTCC module is enabled
- bit 8 **PMPMD:** PMP Module Disable bit
 1 = PMP module is disabled
 0 = PMP module is enabled
- bit 7 **CRCMD:** CRC Module Disable bit
 1 = CRC module is disabled
 0 = CRC module is enabled
- bit 6 **DAC1MD:** DAC1 Module Disable bit
 1 = DAC1 module is disabled
 0 = DAC1 module is enabled
- bit 5-0 **Unimplemented:** Read as '0'

11.0 I/O PORTS

Note 1: This data sheet summarizes the features of the PIC24HJ32GP302/304, PIC24HJ64GPX02/X04 and PIC24HJ128GPX02/X04 families of devices. It is not intended to be a comprehensive reference source. To complement the information in this data sheet, refer to **Section 10. "I/O Ports"** (DS70193) of the "dsPIC33F/PIC24H Family Reference Manual", which is available from the Microchip web site (www.microchip.com).

2: Some registers and associated bits described in this section may not be available on all devices. Refer to **Section 4.0 "Memory Organization"** in this data sheet for device-specific register and bit information.

All of the device pins (except VDD, VSS, MCLR and OSC1/CLKI) are shared among the peripherals and the parallel I/O ports. All I/O input ports feature Schmitt Trigger inputs for improved noise immunity.

11.1 Parallel I/O (PIO) Ports

Generally a parallel I/O port that shares a pin with a peripheral is subservient to the peripheral. The peripheral's output buffer data and control signals are provided to a pair of multiplexers. The multiplexers select whether the peripheral or the associated port

has ownership of the output data and control signals of the I/O pin. The logic also prevents "loop through", in which a port's digital output can drive the input of a peripheral that shares the same pin. **Figure 11-1** shows how ports are shared with other peripherals and the associated I/O pin to which they are connected.

When a peripheral is enabled and the peripheral is actively driving an associated pin, the use of the pin as a general purpose output pin is disabled. The I/O pin can be read, but the output driver for the parallel port bit is disabled. If a peripheral is enabled, but the peripheral is not actively driving a pin, that pin can be driven by a port.

All port pins have three registers directly associated with their operation as digital I/O. The data direction register (TRISx) determines whether the pin is an input or an output. If the data direction bit is a '1', then the pin is an input. All port pins are defined as inputs after a Reset. Reads from the latch (LATx) read the latch. Writes to the latch write the latch. Reads from the port (PORTx) read the port pins, while writes to the port pins write the latch.

Any bit and its associated data and control registers that are not valid for a particular device is disabled. This means the corresponding LATx and TRISx registers and the port pin are read as zeros.

When a pin is shared with another peripheral or function that is defined as an input only, it is nevertheless regarded as a dedicated port because there is no other competing source of outputs.

FIGURE 11-1: BLOCK DIAGRAM OF A TYPICAL SHARED PORT STRUCTURE



11.2 Open-Drain Configuration

In addition to the PORT, LAT and TRIS registers for data control, some port pins can also be individually configured for either digital or open-drain output. This is controlled by the Open-Drain Control register, ODCx, associated with each port. Setting any of the bits configures the corresponding pin to act as an open-drain output.

The open-drain feature allows the generation of outputs higher than VDD (e.g., 5V) on any desired 5V tolerant pins by using external pull-up resistors. The maximum open-drain voltage allowed is the same as the maximum VIH specification.

See “[Pin Diagrams](#)” for the available pins and their functionality.

11.3 Configuring Analog Port Pins

The AD1PCFGL and TRIS registers control the operation of the analog-to-digital (A/D) port pins. The port pins that are to function as analog inputs must have their corresponding TRIS bit set (input). If the TRIS bit is cleared (output), the digital output level (VOH or VOL) is converted.

The AD1PCFGL register has a default value of 0x0000; therefore, all pins that share ANx functions are analog (not digital) by default.

When the PORT register is read, all pins configured as analog input channels are read as cleared (a low level).

Pins configured as digital inputs do not convert an analog input. Analog levels on any pin defined as a digital input (including the ANx pins) can cause the input buffer to consume current that exceeds the device specifications.

11.4 I/O Port Write/Read Timing

One instruction cycle is required between a port direction change or port write operation and a read operation of the same port. Typically this instruction would be an NOP, as shown in [Example 11-1](#).

11.5 Input Change Notification

The input change notification function of the I/O ports allows the PIC24HJ32GP302/304, PIC24HJ64GPX02/X04 and PIC24HJ128GPX02/X04 devices to generate interrupt requests to the processor in response to a change-of-state on selected input pins. This feature can detect input change-of-states even in Sleep mode, when the clocks are disabled. Depending on the device pin count, up to 21 external signals (CNx pin) can be selected (enabled) for generating an interrupt request on a change-of-state.

Four control registers are associated with the CN module. The CNEN1 and CNEN2 registers contain the interrupt enable control bits for each of the CN input pins. Setting any of these bits enables a CN interrupt for the corresponding pins.

Each CN pin also has a weak pull-up connected to it. The pull-ups act as a current source connected to the pin, and eliminate the need for external resistors when push-button or keypad devices are connected. The pull-ups are enabled separately using the CNPU1 and CNPU2 registers, which contain the control bits for each of the CN pins. Setting any of the control bits enables the weak pull-ups for the corresponding pins.

Note: Pull-ups on change notification pins should always be disabled when the port pin is configured as a digital output.

EXAMPLE 11-1: PORT WRITE/READ EXAMPLE

```

MOV    0xFF00, W0           ; Configure PORTB<15:8> as inputs
MOV    W0, TRISBB          ; and PORTB<7:0> as outputs
NOP                               ; Delay 1 cycle
btss   PORTB, #13          ; Next Instruction
    
```

11.6 Peripheral Pin Select

Peripheral pin select configuration enables peripheral set selection and placement on a wide range of I/O pins. By increasing the pinout options available on a particular device, programmers can better tailor the microcontroller to their entire application, rather than trimming the application to fit the device.

The peripheral pin select configuration feature operates over a fixed subset of digital I/O pins. Programmers can independently map the input and/or output of most digital peripherals to any one of these I/O pins. Peripheral pin select is performed in software, and generally does not require the device to be reprogrammed. Hardware safeguards are included that prevent accidental or spurious changes to the peripheral mapping, once it has been established.

11.6.1 AVAILABLE PINS

The peripheral pin select feature is used with a range of up to 26 pins. The number of available pins depends on the particular device and its pin count. Pins that support the peripheral pin select feature include the designation “RPn” in their full pin designation, where “RP” designates a remappable peripheral and “n” is the remappable pin number.

11.6.2 CONTROLLING PERIPHERAL PIN SELECT

Peripheral pin select features are controlled through two sets of special function registers: one to map peripheral inputs, and another one to map outputs. Because they are separately controlled, a particular peripheral’s input and output (if the peripheral has both) can be placed on any selectable function pin without constraint.

The association of a peripheral to a peripheral selectable pin is handled in two different ways, depending on whether an input or output is being mapped.

11.6.2.1 Input Mapping

The inputs of the peripheral pin select options are mapped on the basis of the peripheral. A control register associated with a peripheral dictates the pin it is mapped to. The RPINRx registers are used to configure peripheral input mapping (see [Register 11-1](#) through [Register 11-14](#)). Each register contains sets of 5-bit fields, with each set associated with one of the remappable peripherals. Programming a given peripheral’s bit field with an appropriate 5-bit value maps the RPn pin with that value to that peripheral. For any given device, the valid range of values for any bit field corresponds to the maximum number of peripheral pin selections supported by the device.

[Figure 11-2](#) illustrates remappable pin selection for U1RX input.

Note: For input mapping only, the Peripheral Pin Select (PPS) functionality does not have priority over the TRISx settings. Therefore, when configuring the RPx pin for input, the corresponding bit in the TRISx register must also be configured for input (i.e., set to ‘1’).

FIGURE 11-2: REMAPPABLE MUX INPUT FOR U1RX



PIC24HJ32GP302/304, PIC24HJ64GPX02/X04 AND PIC24HJ128GPX02/X04

TABLE 11-1: SELECTABLE INPUT SOURCES (MAPS INPUT TO FUNCTION)⁽¹⁾

Input Name	Function Name	Register	Configuration Bits
External Interrupt 1	INT1	RPINR0	INT1R<4:0>
External Interrupt 2	INT2	RPINR1	INT2R<4:0>
Timer2 External Clock	T2CK	RPINR3	T2CKR<4:0>
Timer3 External Clock	T3CK	RPINR3	T3CKR<4:0>
Timer4 External Clock	T4CK	RPINR4	T4CKR<4:0>
Timer5 External Clock	T5CK	RPINR4	T5CKR<4:0>
Input Capture 1	IC1	RPINR7	IC1R<4:0>
Input Capture 2	IC2	RPINR7	IC2R<4:0>
Input Capture 7	IC7	RPINR10	IC7R<4:0>
Input Capture 8	IC8	RPINR10	IC8R<4:0>
Output Compare Fault A	OCFA	RPINR11	OCFAR<4:0>
UART1 Receive	U1RX	RPINR18	U1RXR<4:0>
UART1 Clear To Send	$\overline{U1CTS}$	RPINR18	U1CTSR<4:0>
UART2 Receive	U2RX	RPINR19	U2RXR<4:0>
UART2 Clear To Send	$\overline{U2CTS}$	RPINR19	U2CTSR<4:0>
SPI1 Data Input	SDI1	RPINR20	SDI1R<4:0>
SPI1 Clock Input	SCK1	RPINR20	SCK1R<4:0>
SPI1 Slave Select Input	$\overline{SS1}$	RPINR21	SS1R<4:0>
SPI2 Data Input	SDI2	RPINR22	SDI2R<4:0>
SPI2 Clock Input	SCK2	RPINR22	SCK2R<4:0>
SPI2 Slave Select Input	$\overline{SS2}$	RPINR23	SS2R<4:0>
ECAN1 Receive	CIRX	RPINR26	CIRXR<4:0>

Note 1: Unless otherwise noted, all inputs use Schmitt input buffers.

11.6.2.2 Output Mapping

In contrast to inputs, the outputs of the peripheral pin select options are mapped on the basis of the pin. In this case, a control register associated with a particular pin dictates the peripheral output to be mapped. The RPORx registers are used to control output mapping. Like the RPINRx registers, each register contains sets of 5-bit fields, with each set associated with one RPn pin (see Register 11-15 through Register 11-27). The value of the bit field corresponds to one of the peripherals, and that peripheral's output is mapped to the pin (see Table 11-2 and Figure 11-3).

The list of peripherals for output mapping also includes a null value of '00000' because of the mapping technique. This permits any given pin to remain unconnected from the output of any of the pin selectable peripherals.

FIGURE 11-3: MULTIPLEXING OF REMAPPABLE OUTPUT FOR RPn



TABLE 11-2: OUTPUT SELECTION FOR REMAPPABLE PIN (RPn)

Function	RPnR<4:0>	Output Name
NULL	00000	RPn tied to default port pin
C1OUT	00001	RPn tied to Comparator1 Output
C2OUT	00010	RPn tied to Comparator2 Output
U1TX	00011	RPn tied to UART1 Transmit
$\overline{U1RTS}$	00100	RPn tied to UART1 Ready To Send
U2TX	00101	RPn tied to UART2 Transmit
$\overline{U2RTS}$	00110	RPn tied to UART2 Ready To Send
SDO1	00111	RPn tied to SPI1 Data Output
SCK1	01000	RPn tied to SPI1 Clock Output
$\overline{SS1}$	01001	RPn tied to SPI1 Slave Select Output
SDO2	01010	RPn tied to SPI2 Data Output
SCK2	01011	RPn tied to SPI2 Clock Output
$\overline{SS2}$	01100	RPn tied to SPI2 Slave Select Output
C1TX	10000	RPn tied to ECAN1 Transmit
OC1	10010	RPn tied to Output Compare 1
OC2	10011	RPn tied to Output Compare 2
OC3	10100	RPn tied to Output Compare 3
OC4	10101	RPn tied to Output Compare 4

11.6.3 CONTROLLING CONFIGURATION CHANGES

Because peripheral remapping can be changed during run time, some restrictions on peripheral remapping are needed to prevent accidental configuration changes. PIC24H devices include three features to prevent alterations to the peripheral map:

- Control register lock sequence
- Continuous state monitoring
- Configuration bit pin select lock

11.6.3.1 Control Register Lock

Under normal operation, writes to the RPINRx and RPORx registers are not allowed. Attempted writes appear to execute normally, but the contents of the registers remain unchanged. To change these registers, they must be unlocked in hardware. The register lock is controlled by the IOLOCK bit (OSCCON<6>). Setting IOLOCK prevents writes to the control registers; clearing IOLOCK allows writes.

To set or clear IOLOCK, a specific command sequence must be executed:

1. Write 0x46 to OSCCON<7:0>.
2. Write 0x57 to OSCCON<7:0>.
3. Clear (or set) the IOLOCK bit as a single operation.

Note: MPLAB® C30 provides built-in C language functions for unlocking the OSCCON register:

```
__builtin_write_OSCCONL(value)  
__builtin_write_OSCCONH(value)
```

See MPLAB Help for more information.

Unlike the similar sequence with the oscillator's LOCK bit, IOLOCK remains in one state until changed. This allows all of the peripheral pin selects to be configured with a single unlock sequence followed by an update to all control registers, then locked with a second lock sequence.

11.6.3.2 Continuous State Monitoring

In addition to being protected from direct writes, the contents of the RPINRx and RPORx registers are constantly monitored in hardware by shadow registers. If an unexpected change in any of the registers occurs (such as cell disturbances caused by ESD or other external events), a configuration mismatch Reset is triggered.

11.6.3.3 Configuration Bit Pin Select Lock

As an additional level of safety, the device can be configured to prevent more than one write session to the RPINRx and RPORx registers. The IOL1WAY Configuration bit (FOSC<5>) blocks the IOLOCK bit from being cleared after it has been set once. If IOLOCK remains set, the register unlock procedure does not execute, and the peripheral pin select control registers cannot be written to. The only way to clear the bit and re-enable peripheral remapping is to perform a device Reset.

In the default (unprogrammed) state, IOL1WAY is set, restricting users to one write session. Programming IOL1WAY allows user applications unlimited access (with the proper use of the unlock sequence) to the peripheral pin select registers.

11.7 I/O Helpful Tips

1. In some cases, certain pins as defined in [Table 28-9](#) under "Injection Current", have internal protection diodes to VDD and VSS. The term "Injection Current" is also referred to as "Clamp Current". On designated pins, with sufficient external current limiting precautions by the user, I/O pin input voltages are allowed to be greater or less than the data sheet absolute maximum ratings with nominal VDD with respect to the VSS and VDD supplies. Note that when the user application forward biases either of the high or low side internal input clamp diodes, that the resulting current being injected into the device that is clamped internally by the VDD and VSS power rails, may affect the ADC accuracy by four to six counts.
2. I/O pins that are shared with any analog input pin, (i.e., ANx), are always analog pins by default after any reset. Consequently, any pin(s) configured as an analog input pin, automatically disables the digital input pin buffer. As such, any attempt to read a digital input pin will always return a '0' regardless of the digital logic level on the pin if the analog pin is configured. To use a pin as a digital I/O pin on a shared ANx pin, the user application needs to configure the analog pin configuration registers in the ADC module, (i.e., ADxPCFGL, AD1PCFGH), by setting the appropriate bit that corresponds to that I/O port pin to a '1'. On devices with more than one ADC, both analog pin configurations for both ADC modules must be configured as a digital I/O pin for that pin to function as a digital I/O pin.

Note: Although it is not possible to use a digital input pin when its analog function is enabled, it is possible to use the digital I/O output function, TRISx = 0x0, while the analog function is also enabled. However, this is not recommended, particularly if the analog input is connected to an external analog voltage source, which would create signal contention between the analog signal and the output pin driver.

Most I/O pins have multiple functions. Referring to the device pin diagrams in the data sheet, the priorities of the functions allocated to any pins are indicated by reading the pin name from left-to-right. The left most function name takes precedence over any function to its right in the naming convention. For example: AN16/T2CK/T7CK/RC1. This indicates that AN16 is the highest priority in this example and will supersede all other functions to its right in the list. Those other functions to its right, even if enabled, would not work as long as any other function to its left was enabled. This rule applies to all of the functions listed for a given pin.

11.8 I/O Ports Resources

Many useful resources related to I/O Ports are provided on the main product page of the Microchip web site for the devices listed in this data sheet. This product page, which can be accessed using this [link](#), contains the latest updates and additional information.

Note: In the event you are not able to access the product page using the link above, enter this URL in your browser:
<http://www.microchip.com/wwwproducts/Devices.aspx?dDocName=en532315>

11.8.1 KEY RESOURCES

- **Section 10. "I/O Ports"** (DS70193)
- Code Samples
- Application Notes
- Software Libraries
- Webinars
- All related dsPIC33F/PIC24H Family Reference Manuals Sections
- Development Tools

11.9 Peripheral Pin Select Registers

The PIC24HJ32GP302/304, PIC24HJ64GPX02/X04 and PIC24HJ128GPX02/X04 family of devices implement 27 registers for remappable peripheral configuration:

- 14 Input Remappable Peripheral Registers:
 - RPINR0-RPINR1, RPINR3-RPINR4, RPINR7, RPINR10-RPINR11, RPINR18-RPINR23 and PRINR26
- 13 Output Remappable Peripheral Registers:
 - RPOR0-RPOR12

Note: Input and Output Register values can only be changed if the IOLOCK bit (OSCCON<6>) is set to '0'. See [Section 11.6.3.1 "Control Register Lock"](#) for a specific command sequence.

PIC24HJ32GP302/304, PIC24HJ64GPX02/X04 AND PIC24HJ128GPX02/X04

REGISTER 11-1: RPINR0: PERIPHERAL PIN SELECT INPUT REGISTER 0

U-0	U-0	U-0	R/W-1	R/W-1	R/W-1	R/W-1	R/W-1
—	—	—	INT1R<4:0>				
bit 15							bit 8
U-0	U-0	U-0	U-0	U-0	U-0	U-0	U-0
—	—	—	—	—	—	—	—
bit 7							bit 0

Legend:

R = Readable bit W = Writable bit U = Unimplemented bit, read as '0'
 -n = Value at POR '1' = Bit is set '0' = Bit is cleared x = Bit is unknown

bit 15-13 **Unimplemented:** Read as '0'
 bit 12-8 **INT1R<4:0>:** Assign External Interrupt 1 (INTR1) to the corresponding RPn pin
 11111 = Input tied to Vss
 11001 = Input tied to RP25
 .
 .
 .
 00001 = Input tied to RP1
 00000 = Input tied to RP0
 bit 7-0 **Unimplemented:** Read as '0'

REGISTER 11-2: RPINR1: PERIPHERAL PIN SELECT INPUT REGISTER 1

U-0	U-0	U-0	U-0	U-0	U-0	U-0	U-0
—	—	—	—	—	—	—	—
bit 15							bit 8
U-0	U-0	U-0	R/W-1	R/W-1	R/W-1	R/W-1	R/W-1
—	—	—	INT2R<4:0>				
bit 7							bit 0

Legend:

R = Readable bit W = Writable bit U = Unimplemented bit, read as '0'
 -n = Value at POR '1' = Bit is set '0' = Bit is cleared x = Bit is unknown

bit 15-5 **Unimplemented:** Read as '0'
 bit 4-0 **INTR2R<4:0>:** Assign External Interrupt 2 (INTR2) to the corresponding RPn pin
 11111 = Input tied to Vss
 11001 = Input tied to RP25
 .
 .
 .
 00001 = Input tied to RP1
 00000 = Input tied to RP0

REGISTER 11-3: RPINR3: PERIPHERAL PIN SELECT INPUT REGISTER 3

U-0	U-0	U-0	R/W-1	R/W-1	R/W-1	R/W-1	R/W-1
—	—	—	T3CKR<4:0>				
bit 15							bit 8

U-0	U-0	U-0	R/W-1	R/W-1	R/W-1	R/W-1	R/W-1
—	—	—	T2CKR<4:0>				
bit 7							bit 0

Legend:			
R = Readable bit	W = Writable bit	U = Unimplemented bit, read as '0'	
-n = Value at POR	'1' = Bit is set	'0' = Bit is cleared	x = Bit is unknown

bit 15-13 **Unimplemented:** Read as '0'

bit 12-8 **T3CKR<4:0>:** Assign Timer3 External Clock (T3CK) to the corresponding RPn pin

- 11111 = Input tied to Vss
- 11001 = Input tied to RP25

-
-
-

- 00001 = Input tied to RP1
- 00000 = Input tied to RP0

bit 7-5 **Unimplemented:** Read as '0'

bit 4-0 **T2CKR<4:0>:** Assign Timer2 External Clock (T2CK) to the corresponding RPn pin

- 11111 = Input tied to Vss
- 11001 = Input tied to RP25

-
-
-

- 00001 = Input tied to RP1
- 00000 = Input tied to RP0

PIC24HJ32GP302/304, PIC24HJ64GPX02/X04 AND PIC24HJ128GPX02/X04

REGISTER 11-4: RPINR4: PERIPHERAL PIN SELECT INPUT REGISTER 4

U-0	U-0	U-0	R/W-1	R/W-1	R/W-1	R/W-1	R/W-1
—	—	—	T5CKR<4:0>				
bit 15							bit 8

U-0	U-0	U-0	R/W-1	R/W-1	R/W-1	R/W-1	R/W-1
—	—	—	T4CKR<4:0>				
bit 7							bit 0

Legend:

R = Readable bit W = Writable bit U = Unimplemented bit, read as '0'
 -n = Value at POR '1' = Bit is set '0' = Bit is cleared x = Bit is unknown

bit 15-13 **Unimplemented:** Read as '0'

bit 12-8 **T5CKR<4:0>:** Assign Timer5 External Clock (T5CK) to the corresponding RPN pin

11111 = Input tied to Vss
 11001 = Input tied to RP25

•
 •
 •

00001 = Input tied to RP1
 00000 = Input tied to RP0

bit 7-5 **Unimplemented:** Read as '0'

bit 4-0 **T4CKR<4:0>:** Assign Timer4 External Clock (T4CK) to the corresponding RPN pin

11111 = Input tied to Vss
 11001 = Input tied to RP25

•
 •
 •

00001 = Input tied to RP1
 00000 = Input tied to RP0

REGISTER 11-5: RPINR7: PERIPHERAL PIN SELECT INPUT REGISTER 7

U-0	U-0	U-0	R/W-1	R/W-1	R/W-1	R/W-1	R/W-1
—	—	—	IC2R<4:0>				
bit 15							bit 8

U-0	U-0	U-0	R/W-1	R/W-1	R/W-1	R/W-1	R/W-1
—	—	—	IC1R<4:0>				
bit 7							bit 0

Legend:			
R = Readable bit	W = Writable bit	U = Unimplemented bit, read as '0'	
-n = Value at POR	'1' = Bit is set	'0' = Bit is cleared	x = Bit is unknown

bit 15-13 **Unimplemented:** Read as '0'

bit 12-8 **IC2R<4:0>:** Assign Input Capture 2 (IC2) to the corresponding RPn pin

- 11111 = Input tied to Vss
- 11001 = Input tied to RP25
-
-
-
- 00001 = Input tied to RP1
- 00000 = Input tied to RP0

bit 7-5 **Unimplemented:** Read as '0'

bit 4-0 **IC1R<4:0>:** Assign Input Capture 1 (IC1) to the corresponding RPn pin

- 11111 = Input tied to Vss
- 11001 = Input tied to RP25
-
-
-
- 00001 = Input tied to RP1
- 00000 = Input tied to RP0

PIC24HJ32GP302/304, PIC24HJ64GPX02/X04 AND PIC24HJ128GPX02/X04

REGISTER 11-6: RPINR10: PERIPHERAL PIN SELECT INPUT REGISTERS 10

U-0	U-0	U-0	R/W-1	R/W-1	R/W-1	R/W-1	R/W-1
—	—	—	IC8R<4:0>				
bit 15							bit 8

U-0	U-0	U-0	R/W-1	R/W-1	R/W-1	R/W-1	R/W-1
—	—	—	IC7R<4:0>				
bit 7							bit 0

Legend:

R = Readable bit	W = Writable bit	U = Unimplemented bit, read as '0'
-n = Value at POR	'1' = Bit is set	'0' = Bit is cleared
		x = Bit is unknown

bit 15-13 **Unimplemented:** Read as '0'

bit 12-8 **IC8R<4:0>:** Assign Input Capture 8 (IC8) to the corresponding RPn pin

11111 = Input tied to Vss
11001 = Input tied to RP25

•
•
•

00001 = Input tied to RP1
00000 = Input tied to RP0

bit 7-5 **Unimplemented:** Read as '0'

bit 4-0 **IC7R<4:0>:** Assign Input Capture 7 (IC7) to the corresponding RPn pin

11111 = Input tied to Vss
11001 = Input tied to RP25

•
•
•

00001 = Input tied to RP1
00000 = Input tied to RP0

REGISTER 11-7: RPINR11: PERIPHERAL PIN SELECT INPUT REGISTER 11

U-0	U-0	U-0	U-0	U-0	U-0	U-0	U-0
—	—	—	—	—	—	—	—
bit 15							bit 8

U-0	U-0	U-0	R/W-1	R/W-1	R/W-1	R/W-1	R/W-1
—	—	—	OCFAR<4:0>				
bit 7							bit 0

Legend:			
R = Readable bit	W = Writable bit	U = Unimplemented bit, read as '0'	
-n = Value at POR	'1' = Bit is set	'0' = Bit is cleared	x = Bit is unknown

- bit 15-5 **Unimplemented:** Read as '0'
- bit 4-0 **OCFAR<4:0>:** Assign Output Compare A (OCFA) to the corresponding RPn pin
 - 11111 = Input tied to Vss
 - 11001 = Input tied to RP25
 -
 -
 -
 - 00001 = Input tied to RP1
 - 00000 = Input tied to RP0

PIC24HJ32GP302/304, PIC24HJ64GPX02/X04 AND PIC24HJ128GPX02/X04

REGISTER 11-8: RPINR18: PERIPHERAL PIN SELECT INPUT REGISTER 18

U-0	U-0	U-0	R/W-1	R/W-1	R/W-1	R/W-1	R/W-1
—	—	—	U1CTSR<4:0>				
bit 15							bit 8

U-0	U-0	U-0	R/W-1	R/W-1	R/W-1	R/W-1	R/W-1
—	—	—	U1RXR<4:0>				
bit 7							bit 0

Legend:

R = Readable bit W = Writable bit U = Unimplemented bit, read as '0'
 -n = Value at POR '1' = Bit is set '0' = Bit is cleared x = Bit is unknown

- bit 15-13 **Unimplemented:** Read as '0'
- bit 12-8 **U1CTSR<4:0>:** Assign UART1 Clear to Send (U1CTS) to the corresponding RPn pin
 - 11111 = Input tied to Vss
 - 11001 = Input tied to RP25
 -
 -
 -
 - 00001 = Input tied to RP1
 - 00000 = Input tied to RP0
- bit 7-5 **Unimplemented:** Read as '0'
- bit 4-0 **U1RXR<4:0>:** Assign UART1 Receive (U1RX) to the corresponding RPn pin
 - 11111 = Input tied to Vss
 - 11001 = Input tied to RP25
 -
 -
 -
 - 00001 = Input tied to RP1
 - 00000 = Input tied to RP0

REGISTER 11-9: RPINR19: PERIPHERAL PIN SELECT INPUT REGISTER 19

U-0	U-0	U-0	R/W-1	R/W-1	R/W-1	R/W-1	R/W-1
—	—	—	U2CTSR<4:0>				
bit 15							bit 8

U-0	U-0	U-0	R/W-1	R/W-1	R/W-1	R/W-1	R/W-1
—	—	—	U2RXR<4:0>				
bit 7							bit 0

Legend:			
R = Readable bit	W = Writable bit	U = Unimplemented bit, read as '0'	
-n = Value at POR	'1' = Bit is set	'0' = Bit is cleared	x = Bit is unknown

bit 15-13 **Unimplemented:** Read as '0'

bit 12-8 **U2CTSR<4:0>:** Assign UART2 Clear to Send (U2CTS) to the corresponding RPn pin

11111 = Input tied to Vss

11001 = Input tied to RP25

-
-
-

00001 = Input tied to RP1

00000 = Input tied to RP0

bit 7-5 **Unimplemented:** Read as '0'

bit 4-0 **U2RXR<4:0>:** Assign UART2 Receive (U2RX) to the corresponding RPn pin

11111 = Input tied to Vss

11001 = Input tied to RP25

-
-
-

00001 = Input tied to RP1

00000 = Input tied to RP0

REGISTER 11-10: RPINR20: PERIPHERAL PIN SELECT INPUT REGISTER 20

U-0	U-0	U-0	R/W-1	R/W-1	R/W-1	R/W-1	R/W-1
—	—	—	SCK1R<4:0>				
bit 15							bit 8

U-0	U-0	U-0	R/W-1	R/W-1	R/W-1	R/W-1	R/W-1
—	—	—	SDI1R<4:0>				
bit 7							bit 0

Legend:

R = Readable bit	W = Writable bit	U = Unimplemented bit, read as '0'
-n = Value at POR	'1' = Bit is set	'0' = Bit is cleared x = Bit is unknown

bit 15-13 **Unimplemented:** Read as '0'

bit 12-8 **SCK1R<4:0>:** Assign SPI1 Clock Input (SCK1) to the corresponding RPn pin

11111 = Input tied to Vss
 11001 = Input tied to RP25

-
-
-

00001 = Input tied to RP1
 00000 = Input tied to RP0

bit 7-5 **Unimplemented:** Read as '0'

bit 4-0 **SDI1R<4:0>:** Assign SPI1 Data Input (SDI1) to the corresponding RPn pin

11111 = Input tied to Vss
 11001 = Input tied to RP25

-
-
-

00001 = Input tied to RP1
 00000 = Input tied to RP0

REGISTER 11-11: RPINR21: PERIPHERAL PIN SELECT INPUT REGISTER 21

U-0	U-0	U-0	U-0	U-0	U-0	U-0	U-0
—	—	—	—	—	—	—	—
bit 15						bit 8	

U-0	U-0	U-0	R/W-1	R/W-1	R/W-1	R/W-1	R/W-1
—	—	—	SS1R<4:0>				
bit 7						bit 0	

Legend:			
R = Readable bit	W = Writable bit	U = Unimplemented bit, read as '0'	
-n = Value at POR	'1' = Bit is set	'0' = Bit is cleared	x = Bit is unknown

- bit 15-5 **Unimplemented:** Read as '0'
- bit 4-0 **SS1R<4:0>:** Assign SPI1 Slave Select Input ($\overline{SS1}$) to the corresponding RPn pin
 - 11111 = Input tied to Vss
 - 11001 = Input tied to RP25
 -
 -
 -
 - 00001 = Input tied to RP1
 - 00000 = Input tied to RP0

PIC24HJ32GP302/304, PIC24HJ64GPX02/X04 AND PIC24HJ128GPX02/X04

REGISTER 11-12: RPINR22: PERIPHERAL PIN SELECT INPUT REGISTER 22

U-0	U-0	U-0	R/W-1	R/W-1	R/W-1	R/W-1	R/W-1
—	—	—	SCK2R<4:0>				
bit 15							bit 8

U-0	U-0	U-0	R/W-1	R/W-1	R/W-1	R/W-1	R/W-1
—	—	—	SDI2R<4:0>				
bit 7							bit 0

Legend:

R = Readable bit	W = Writable bit	U = Unimplemented bit, read as '0'
-n = Value at POR	'1' = Bit is set	'0' = Bit is cleared x = Bit is unknown

bit 15-13 **Unimplemented:** Read as '0'

bit 12-8 **SCK2R<4:0>:** Assign SPI2 Clock Input (SCK2) to the corresponding RPn pin

11111 = Input tied to Vss
11001 = Input tied to RP25

•
•
•

00001 = Input tied to RP1
00000 = Input tied to RP0

bit 7-5 **Unimplemented:** Read as '0'

bit 4-0 **SDI2R<4:0>:** Assign SPI2 Data Input (SDI2) to the corresponding RPn pin

11111 = Input tied to Vss
11001 = Input tied to RP25

•
•
•

00001 = Input tied to RP1
00000 = Input tied to RP0

REGISTER 11-13: RPINR23: PERIPHERAL PIN SELECT INPUT REGISTER 23

U-0	U-0	U-0	U-0	U-0	U-0	U-0	U-0
—	—	—	—	—	—	—	—
bit 15							bit 8
U-0	U-0	U-0	R/W-1	R/W-1	R/W-1	R/W-1	R/W-1
—	—	—	SS2R<4:0>				
bit 7							bit 0

Legend:
 R = Readable bit W = Writable bit U = Unimplemented bit, read as '0'
 -n = Value at POR '1' = Bit is set '0' = Bit is cleared x = Bit is unknown

bit 15-5 **Unimplemented:** Read as '0'
 bit 4-0 **SS2R<4:0>:** Assign SPI2 Slave Select Input ($\overline{SS2}$) to the corresponding RPn pin
 11111 = Input tied to Vss
 11001 = Input tied to RP25
 •
 •
 •
 00001 = Input tied to RP1
 00000 = Input tied to RP0

REGISTER 11-14: RPINR26: PERIPHERAL PIN SELECT INPUT REGISTER 26⁽¹⁾

U-0	U-0	U-0	U-0	U-0	U-0	U-0	U-0
—	—	—	—	—	—	—	—
bit 15							bit 8
U-0	U-0	U-0	R/W-1	R/W-1	R/W-1	R/W-1	R/W-1
—	—	—	C1RXR<4:0>				
bit 7							bit 0

Legend:
 R = Readable bit W = Writable bit U = Unimplemented bit, read as '0'
 -n = Value at POR '1' = Bit is set '0' = Bit is cleared x = Bit is unknown

bit 15-5 **Unimplemented:** Read as '0'
 bit 4-0 **C1RXR<4:0>:** Assign ECAN1 Receive (C1RX) to the corresponding RPn pin
 11111 = Input tied to Vss
 11001 = Input tied to RP25
 •
 •
 •
 00001 = Input tied to RP1
 00000 = Input tied to RP0

Note 1: This register is disabled on devices without ECAN™ modules.

PIC24HJ32GP302/304, PIC24HJ64GPX02/X04 AND PIC24HJ128GPX02/X04

REGISTER 11-15: RPOR0: PERIPHERAL PIN SELECT OUTPUT REGISTERS 0

U-0	U-0	U-0	R/W-0	R/W-0	R/W-0	R/W-0	R/W-0
—	—	—	RP1R<4:0>				
bit 15							bit 8

U-0	U-0	U-0	R/W-0	R/W-0	R/W-0	R/W-0	R/W-0
—	—	—	RP0R<4:0>				
bit 7							bit 0

Legend:

R = Readable bit W = Writable bit U = Unimplemented bit, read as '0'
-n = Value at POR '1' = Bit is set '0' = Bit is cleared x = Bit is unknown

- bit 15-13 **Unimplemented:** Read as '0'
- bit 12-8 **RP1R<4:0>:** Peripheral Output Function is Assigned to RP1 Output Pin bits (see [Table 11-2](#) for peripheral function numbers)
- bit 7-5 **Unimplemented:** Read as '0'
- bit 4-0 **RP0R<4:0>:** Peripheral Output Function is Assigned to RP0 Output Pin bits (see [Table 11-2](#) for peripheral function numbers)

REGISTER 11-16: RPOR1: PERIPHERAL PIN SELECT OUTPUT REGISTERS 1

U-0	U-0	U-0	R/W-0	R/W-0	R/W-0	R/W-0	R/W-0
—	—	—	RP3R<4:0>				
bit 15							bit 8

U-0	U-0	U-0	R/W-0	R/W-0	R/W-0	R/W-0	R/W-0
—	—	—	RP2R<4:0>				
bit 7							bit 0

Legend:

R = Readable bit W = Writable bit U = Unimplemented bit, read as '0'
-n = Value at POR '1' = Bit is set '0' = Bit is cleared x = Bit is unknown

- bit 15-13 **Unimplemented:** Read as '0'
- bit 12-8 **RP3R<4:0>:** Peripheral Output Function is Assigned to RP3 Output Pin bits (see [Table 11-2](#) for peripheral function numbers)
- bit 7-5 **Unimplemented:** Read as '0'
- bit 4-0 **RP2R<4:0>:** Peripheral Output Function is Assigned to RP2 Output Pin bits (see [Table 11-2](#) for peripheral function numbers)

REGISTER 11-17: RPOR2: PERIPHERAL PIN SELECT OUTPUT REGISTERS 2

U-0	U-0	U-0	R/W-0	R/W-0	R/W-0	R/W-0	R/W-0
—	—	—	RP5R<4:0>				
bit 15							bit 8

U-0	U-0	U-0	R/W-0	R/W-0	R/W-0	R/W-0	R/W-0
—	—	—	RP4R<4:0>				
bit 7							bit 0

Legend:							
R = Readable bit	W = Writable bit	U = Unimplemented bit, read as '0'					
-n = Value at POR	'1' = Bit is set	'0' = Bit is cleared	x = Bit is unknown				

- bit 15-13 **Unimplemented:** Read as '0'
- bit 12-8 **RP5R<4:0>:** Peripheral Output Function is Assigned to RP5 Output Pin bits (see [Table 11-2](#) for peripheral function numbers)
- bit 7-5 **Unimplemented:** Read as '0'
- bit 4-0 **RP4R<4:0>:** Peripheral Output Function is Assigned to RP4 Output Pin bits (see [Table 11-2](#) for peripheral function numbers)

REGISTER 11-18: RPOR3: PERIPHERAL PIN SELECT OUTPUT REGISTERS 3

U-0	U-0	U-0	R/W-0	R/W-0	R/W-0	R/W-0	R/W-0
—	—	—	RP7R<4:0>				
bit 15							bit 8

U-0	U-0	U-0	R/W-0	R/W-0	R/W-0	R/W-0	R/W-0
—	—	—	RP6R<4:0>				
bit 7							bit 0

Legend:							
R = Readable bit	W = Writable bit	U = Unimplemented bit, read as '0'					
-n = Value at POR	'1' = Bit is set	'0' = Bit is cleared	x = Bit is unknown				

- bit 15-13 **Unimplemented:** Read as '0'
- bit 12-8 **RP7R<4:0>:** Peripheral Output Function is Assigned to RP7 Output Pin bits (see [Table 11-2](#) for peripheral function numbers)
- bit 7-5 **Unimplemented:** Read as '0'
- bit 4-0 **RP6R<4:0>:** Peripheral Output Function is Assigned to RP6 Output Pin bits (see [Table 11-2](#) for peripheral function numbers)

PIC24HJ32GP302/304, PIC24HJ64GPX02/X04 AND PIC24HJ128GPX02/X04

REGISTER 11-19: RPOR4: PERIPHERAL PIN SELECT OUTPUT REGISTERS 4

U-0	U-0	U-0	R/W-0	R/W-0	R/W-0	R/W-0	R/W-0
—	—	—	RP9R<4:0>				
bit 15							bit 8

U-0	U-0	U-0	R/W-0	R/W-0	R/W-0	R/W-0	R/W-0
—	—	—	RP8R<4:0>				
bit 7							bit 0

Legend:

R = Readable bit W = Writable bit U = Unimplemented bit, read as '0'
 -n = Value at POR '1' = Bit is set '0' = Bit is cleared x = Bit is unknown

- bit 15-13 **Unimplemented:** Read as '0'
- bit 12-8 **RP9R<4:0>:** Peripheral Output Function is Assigned to RP9 Output Pin bits (see [Table 11-2](#) for peripheral function numbers)
- bit 7-5 **Unimplemented:** Read as '0'
- bit 4-0 **RP8R<4:0>:** Peripheral Output Function is Assigned to RP8 Output Pin bits (see [Table 11-2](#) for peripheral function numbers)

REGISTER 11-20: RPOR5: PERIPHERAL PIN SELECT OUTPUT REGISTERS 5

U-0	U-0	U-0	R/W-0	R/W-0	R/W-0	R/W-0	R/W-0
—	—	—	RP11R<4:0>				
bit 15							bit 8

U-0	U-0	U-0	R/W-0	R/W-0	R/W-0	R/W-0	R/W-0
—	—	—	RP10R<4:0>				
bit 7							bit 0

Legend:

R = Readable bit W = Writable bit U = Unimplemented bit, read as '0'
 -n = Value at POR '1' = Bit is set '0' = Bit is cleared x = Bit is unknown

- bit 15-13 **Unimplemented:** Read as '0'
- bit 12-8 **RP11R<4:0>:** Peripheral Output Function is Assigned to RP11 Output Pin bits (see [Table 11-2](#) for peripheral function numbers)
- bit 7-5 **Unimplemented:** Read as '0'
- bit 4-0 **RP10R<4:0>:** Peripheral Output Function is Assigned to RP10 Output Pin bits (see [Table 11-2](#) for peripheral function numbers)

REGISTER 11-21: RPOR6: PERIPHERAL PIN SELECT OUTPUT REGISTERS 6

U-0	U-0	U-0	R/W-0	R/W-0	R/W-0	R/W-0	R/W-0
—	—	—	RP13R<4:0>				
bit 15							bit 8

U-0	U-0	U-0	R/W-0	R/W-0	R/W-0	R/W-0	R/W-0
—	—	—	RP12R<4:0>				
bit 7							bit 0

Legend:							
R = Readable bit	W = Writable bit	U = Unimplemented bit, read as '0'					
-n = Value at POR	'1' = Bit is set	'0' = Bit is cleared	x = Bit is unknown				

- bit 15-13 **Unimplemented:** Read as '0'
- bit 12-8 **RP13R<4:0>:** Peripheral Output Function is Assigned to RP13 Output Pin bits (see [Table 11-2](#) for peripheral function numbers)
- bit 7-5 **Unimplemented:** Read as '0'
- bit 4-0 **RP12R<4:0>:** Peripheral Output Function is Assigned to RP12 Output Pin bits (see [Table 11-2](#) for peripheral function numbers)

REGISTER 11-22: RPOR7: PERIPHERAL PIN SELECT OUTPUT REGISTERS 7

U-0	U-0	U-0	R/W-0	R/W-0	R/W-0	R/W-0	R/W-0
—	—	—	RP15R<4:0>				
bit 15							bit 8

U-0	U-0	U-0	R/W-0	R/W-0	R/W-0	R/W-0	R/W-0
—	—	—	RP14R<4:0>				
bit 7							bit 0

Legend:							
R = Readable bit	W = Writable bit	U = Unimplemented bit, read as '0'					
-n = Value at POR	'1' = Bit is set	'0' = Bit is cleared	x = Bit is unknown				

- bit 15-13 **Unimplemented:** Read as '0'
- bit 12-8 **RP15R<4:0>:** Peripheral Output Function is Assigned to RP15 Output Pin bits (see [Table 11-2](#) for peripheral function numbers)
- bit 7-5 **Unimplemented:** Read as '0'
- bit 4-0 **RP14R<4:0>:** Peripheral Output Function is Assigned to RP14 Output Pin bits (see [Table 11-2](#) for peripheral function numbers)

PIC24HJ32GP302/304, PIC24HJ64GPX02/X04 AND PIC24HJ128GPX02/X04

REGISTER 11-23: RPOR8: PERIPHERAL PIN SELECT OUTPUT REGISTERS 8⁽¹⁾

U-0	U-0	U-0	R/W-0	R/W-0	R/W-0	R/W-0	R/W-0
—	—	—	RP17R<4:0>				
bit 15							bit 8

U-0	U-0	U-0	R/W-0	R/W-0	R/W-0	R/W-0	R/W-0
—	—	—	RP16R<4:0>				
bit 7							bit 0

Legend:

R = Readable bit

W = Writable bit

U = Unimplemented bit, read as '0'

-n = Value at POR

'1' = Bit is set

'0' = Bit is cleared

x = Bit is unknown

bit 15-13 **Unimplemented:** Read as '0'

bit 12-8 **RP17R<4:0>:** Peripheral Output Function is Assigned to RP17 Output Pin bits (see [Table 11-2](#) for peripheral function numbers)

bit 7-5 **Unimplemented:** Read as '0'

bit 4-0 **RP16R<4:0>:** Peripheral Output Function is Assigned to RP16 Output Pin bits (see [Table 11-2](#) for peripheral function numbers)

Note 1: This register is implemented in 44-pin devices only.

REGISTER 11-24: RPOR9: PERIPHERAL PIN SELECT OUTPUT REGISTERS 9⁽¹⁾

U-0	U-0	U-0	R/W-0	R/W-0	R/W-0	R/W-0	R/W-0
—	—	—	RP19R<4:0>				
bit 15							bit 8

U-0	U-0	U-0	R/W-0	R/W-0	R/W-0	R/W-0	R/W-0
—	—	—	RP18R<4:0>				
bit 7							bit 0

Legend:

R = Readable bit

W = Writable bit

U = Unimplemented bit, read as '0'

-n = Value at POR

'1' = Bit is set

'0' = Bit is cleared

x = Bit is unknown

bit 15-13 **Unimplemented:** Read as '0'

bit 12-8 **RP19R<4:0>:** Peripheral Output Function is Assigned to RP19 Output Pin bits (see [Table 11-2](#) for peripheral function numbers)

bit 7-5 **Unimplemented:** Read as '0'

bit 4-0 **RP18R<4:0>:** Peripheral Output Function is Assigned to RP18 Output Pin bits (see [Table 11-2](#) for peripheral function numbers)

Note 1: This register is implemented in 44-pin devices only.

REGISTER 11-25: RPOR10: PERIPHERAL PIN SELECT OUTPUT REGISTERS 10⁽¹⁾

U-0	U-0	U-0	R/W-0	R/W-0	R/W-0	R/W-0	R/W-0
—	—	—	RP21R<4:0>				
bit 15							bit 8

U-0	U-0	U-0	R/W-0	R/W-0	R/W-0	R/W-0	R/W-0
—	—	—	RP20R<4:0>				
bit 7							bit 0

Legend:							
R = Readable bit	W = Writable bit	U = Unimplemented bit, read as '0'					
-n = Value at POR	'1' = Bit is set	'0' = Bit is cleared	x = Bit is unknown				

- bit 15-13 **Unimplemented:** Read as '0'
- bit 12-8 **RP21R<4:0>:** Peripheral Output Function is Assigned to RP21 Output Pin bits (see [Table 11-2](#) for peripheral function numbers)
- bit 7-5 **Unimplemented:** Read as '0'
- bit 4-0 **RP20R<4:0>:** Peripheral Output Function is Assigned to RP20 Output Pin bits (see [Table 11-2](#) for peripheral function numbers)

Note 1: This register is implemented in 44-pin devices only.

REGISTER 11-26: RPOR11: PERIPHERAL PIN SELECT OUTPUT REGISTERS 11⁽¹⁾

U-0	U-0	U-0	R/W-0	R/W-0	R/W-0	R/W-0	R/W-0
—	—	—	RP23R<4:0>				
bit 15							bit 8

U-0	U-0	U-0	R/W-0	R/W-0	R/W-0	R/W-0	R/W-0
—	—	—	RP22R<4:0>				
bit 7							bit 0

Legend:							
R = Readable bit	W = Writable bit	U = Unimplemented bit, read as '0'					
-n = Value at POR	'1' = Bit is set	'0' = Bit is cleared	x = Bit is unknown				

- bit 15-13 **Unimplemented:** Read as '0'
- bit 12-8 **RP23R<4:0>:** Peripheral Output Function is Assigned to RP23 Output Pin bits (see [Table 11-2](#) for peripheral function numbers)
- bit 7-5 **Unimplemented:** Read as '0'
- bit 4-0 **RP22R<4:0>:** Peripheral Output Function is Assigned to RP22 Output Pin bits (see [Table 11-2](#) for peripheral function numbers)

Note 1: This register is implemented in 44-pin devices only.

PIC24HJ32GP302/304, PIC24HJ64GPX02/X04 AND PIC24HJ128GPX02/X04

REGISTER 11-27: RPOR12: PERIPHERAL PIN SELECT OUTPUT REGISTERS 12⁽¹⁾

U-0	U-0	U-0	R/W-0	R/W-0	R/W-0	R/W-0	R/W-0
—	—	—	RP25R<4:0>				
bit 15							bit 8

U-0	U-0	U-0	R/W-0	R/W-0	R/W-0	R/W-0	R/W-0
—	—	—	RP24R<4:0>				
bit 7							bit 0

Legend:

R = Readable bit

W = Writable bit

U = Unimplemented bit, read as '0'

-n = Value at POR

'1' = Bit is set

'0' = Bit is cleared

x = Bit is unknown

bit 15-13 **Unimplemented:** Read as '0'

bit 12-8 **RP25R<4:0>:** Peripheral Output Function is Assigned to RP25 Output Pin bits (see [Table 11-2](#) for peripheral function numbers)

bit 7-5 **Unimplemented:** Read as '0'

bit 4-0 **RP24R<4:0>:** Peripheral Output Function is Assigned to RP24 Output Pin bits (see [Table 11-2](#) for peripheral function numbers)

Note 1: This register is implemented in 44-pin devices only.

12.0 TIMER1

Note 1: This data sheet summarizes the features of the PIC24HJ32GP302/304, PIC24HJ64GPX02/X04 and PIC24HJ128GPX02/X04 families of devices. It is not intended to be a comprehensive reference source. To complement the information in this data sheet, refer to **Section 11. “Timers”** (DS70205) of the “*dsPIC33F/PIC24H Family Reference Manual*”, which is available from the Microchip web site (www.microchip.com).

2: Some registers and associated bits described in this section may not be available on all devices. Refer to **Section 4.0 “Memory Organization”** in this data sheet for device-specific register and bit information.

The Timer1 module is a 16-bit timer, which can serve as the time counter for the real-time clock, or operate as a free-running interval timer/counter.

The Timer1 module has the following unique features over other timers:

- Can be operated from the low power 32 kHz crystal oscillator available on the device
- Can be operated in Asynchronous Counter mode from an external clock source.
- The external clock input (T1CK) can optionally be synchronized to the internal device clock and the clock synchronization is performed after the prescaler.

The unique features of Timer1 allow it to be used for Real Time Clock (RTC) applications. A block diagram of Timer1 is shown in [Figure 12-1](#).

The Timer1 module can operate in one of the following modes:

- Timer mode
- Gated Timer mode
- Synchronous Counter mode
- Asynchronous Counter mode

In Timer and Gated Timer modes, the input clock is derived from the internal instruction cycle clock (FCY). In Synchronous and Asynchronous Counter modes, the input clock is derived from the external clock input at the T1CK pin.

The Timer modes are determined by the following bits:

- Timer Clock Source Control bit (TCS): T1CON<1>
- Timer Synchronization Control bit (TSYNC): T1CON<2>
- Timer Gate Control bit (TGATE): T1CON<6>

Timer control bit setting for different operating modes are given in the [Table 12-1](#).

TABLE 12-1: TIMER MODE SETTINGS

Mode	TCS	TGATE	TSYNC
Timer	0	0	x
Gated timer	0	1	x
Synchronous counter	1	x	1
Asynchronous counter	1	x	0

FIGURE 12-1: 16-BIT TIMER1 MODULE BLOCK DIAGRAM



12.1 Timer Resources

Many useful resources related to Timers are provided on the main product page of the Microchip web site for the devices listed in this data sheet. This product page, which can be accessed using this [link](#), contains the latest updates and additional information.

<p>Note: In the event you are not able to access the product page using the link above, enter this URL in your browser: http://www.microchip.com/wwwproducts/Devices.aspx?dDocName=en532315</p>
--

12.1.1 KEY RESOURCES

- **Section 11. “Timers”** (DS70205)
- Code Samples
- Application Notes
- Software Libraries
- Webinars
- All related dsPIC33F/PIC24H Family Reference Manuals Sections
- Development Tools

12.2 Timer1 Control Register

REGISTER 12-1: T1CON: TIMER1 CONTROL REGISTER

R/W-0	U-0	R/W-0	U-0	U-0	U-0	U-0	U-0
TON	—	TSIDL	—	—	—	—	—
bit 15							bit 8

U-0	R/W-0	R/W-0	R/W-0	U-0	R/W-0	R/W-0	U-0
—	TGATE	TCKPS<1:0>		—	TSYNC	TCS	—
bit 7							bit 0

Legend:

R = Readable bit W = Writable bit U = Unimplemented bit, read as '0'
 -n = Value at POR '1' = Bit is set '0' = Bit is cleared x = Bit is unknown

- bit 15 **TON:** Timer1 On bit
 1 = Starts 16-bit Timer1
 0 = Stops 16-bit Timer1
- bit 14 **Unimplemented:** Read as '0'
- bit 13 **TSIDL:** Stop in Idle Mode bit
 1 = Discontinue module operation when device enters Idle mode
 0 = Continue module operation in Idle mode
- bit 12-7 **Unimplemented:** Read as '0'
- bit 6 **TGATE:** Timer1 Gated Time Accumulation Enable bit
 When TCS = 1:
 This bit is ignored.
 When TCS = 0:
 1 = Gated time accumulation enabled
 0 = Gated time accumulation disabled
- bit 5-4 **TCKPS<1:0>:** Timer1 Input Clock Prescaler Select bits
 11 = 1:256
 10 = 1:64
 01 = 1:8
 00 = 1:1
- bit 3 **Unimplemented:** Read as '0'
- bit 2 **TSYNC:** Timer1 External Clock Input Synchronization Select bit
 When TCS = 1:
 1 = Synchronize external clock input
 0 = Do not synchronize external clock input
 When TCS = 0:
 This bit is ignored.
- bit 1 **TCS:** Timer1 Clock Source Select bit
 1 = External clock from pin T1CK (on the rising edge)
 0 = Internal clock (FCY)
- bit 0 **Unimplemented:** Read as '0'

NOTES:

13.0 TIMER2/3 AND TIMER4/5 FEATURE

Note 1: This data sheet summarizes the features of the PIC24HJ32GP302/304, PIC24HJ64GPX02/X04 and PIC24HJ128GPX02/X04 families of devices. It is not intended to be a comprehensive reference source. To complement the information in this data sheet, refer to **Section 11. "Timers"** (DS70205) of the "*dsPIC33F/PIC24H Family Reference Manual*", which is available from the Microchip web site (www.microchip.com).

2: Some registers and associated bits described in this section may not be available on all devices. Refer to **Section 4.0 "Memory Organization"** in this data sheet for device-specific register and bit information.

- A Type B timer can be concatenated with a Type C timer to form a 32-bit timer
- The external clock input (TxCK) is always synchronized to the internal device clock and the clock synchronization is performed after the prescaler

A block diagram of the Type B timer is shown in [Figure 13-1](#).

Timer3 and Timer5 are Type C timers with the following specific features:

- A Type C timer can be concatenated with a Type B timer to form a 32-bit timer
- At least one Type C timer has the ability to trigger an A/D conversion
- The external clock input (TxCK) is always synchronized to the internal device clock and the clock synchronization is performed before the prescaler

A block diagram of the Type C timer is shown in [Figure 13-2](#).

Timer2 and Timer4 are Type B timers with the following specific features:

FIGURE 13-1: TYPE B TIMER BLOCK DIAGRAM (x = 2 or 4)



FIGURE 13-2: TYPE C TIMER BLOCK DIAGRAM (x = 3 or 5)



The Timer2/3 and Timer4/5 modules can operate in one of the following modes:

- Timer mode
- Gated Timer mode
- Synchronous Counter mode

In Timer and Gated Timer modes, the input clock is derived from the internal instruction cycle clock (FCY). In Synchronous Counter mode, the input clock is derived from the external clock input at TxCK pin.

The timer modes are determined by the following bits:

- TCS (TxCON<1>): Timer Clock Source Control bit
- TGATE (TxCON<6>): Timer Gate Control bit

Timer control bit settings for different operating modes are given in the [Table 13-1](#).

TABLE 13-1: TIMER MODE SETTINGS

Mode	TCS	TGATE
Timer	0	0
Gated timer	0	1
Synchronous counter	1	x

13.1 16-Bit Operation

To configure any of the timers for individual 16-bit operation:

1. Clear the T32 bit corresponding to that timer.
2. Select the timer prescaler ratio using the TCKPS<1:0> bits.
3. Set the Clock and Gating modes using the TCS and TGATE bits.
4. Load the timer period value into the PRx register.
5. If interrupts are required, set the interrupt enable bit, TxIE. Use the priority bits, TxIP<2:0>, to set the interrupt priority.
6. Set the TON bit.

Note: Only Timer2 and Timer3 can trigger a DMA data transfer.

13.2 32-Bit Operation

A 32-bit timer module can be formed by combining a Type B and a Type C 16-bit timer module. For 32-bit timer operation, the T32 control bit in the Type B Timer Control register (TxCON<3>) must be set. The Type C timer holds the most significant word (msw) and the Type B timer holds the least significant word (lsw) for 32-bit operation.

When configured for 32-bit operation, only the Type B Timer Control register (TxCON) bits are required for setup and control. Type C timer control register bits are ignored (except TSIDL bit).

For interrupt control, the combined 32-bit timer uses the interrupt enable, interrupt flag and interrupt priority control bits of the Type C timer. The interrupt control and status bits for the Type B timer are ignored during 32-bit timer operation.

The Type B and Type C timers that can be combined to form a 32-bit timer are listed in [Table 13-2](#).

TABLE 13-2: 32-BIT TIMER

TYPE B Timer (lsw)	TYPE C Timer (msw)
Timer2	Timer3
Timer4	Timer5

A block diagram representation of the 32-bit timer module is shown in [Figure 13-3](#). The 32-timer module can operate in one of the following modes:

- Timer mode
- Gated Timer mode
- Synchronous Counter mode

To configure the features of Timer2/3 or Timer4/5 for 32-bit operation:

1. Set the T32 control bit.
2. Select the prescaler ratio for Timer2 or Timer4 using the TCKPS<1:0> bits.
3. Set the Clock and Gating modes using the corresponding TCS and TGATE bits.
4. Load the timer period value. PR3 or PR5 contains the most significant word of the value, while PR2 or PR4 contains the least significant word.
5. If interrupts are required, set the interrupt enable bits, T3IE or T5IE. Use the priority bits, T3IP<2:0> or T5IP<2:0> to set the interrupt priority. While Timer2 or Timer4 controls the timer, the interrupt appears as a Timer3 or Timer5 interrupt.
6. Set the corresponding TON bit.

The timer value at any point is stored in the register pair, TMR3:TMR2 or TMR5:TMR4, which always contains the most significant word of the count, while TMR2 or TMR4 contains the least significant word.

FIGURE 13-3: 32-BIT TIMER BLOCK DIAGRAM



13.3 Timer Resources

Many useful resources related to Timers are provided on the main product page of the Microchip web site for the devices listed in this data sheet. This product page, which can be accessed using this [link](#), contains the latest updates and additional information.

Note: In the event you are not able to access the product page using the link above, enter this URL in your browser:
<http://www.microchip.com/wwwproducts/Devices.aspx?dDocName=en532315>

13.3.1 KEY RESOURCES

- **Section 11. “Timers”** (DS70205)
- Code Samples
- Application Notes
- Software Libraries
- Webinars
- All related dsPIC33F/PIC24H Family Reference Manuals Sections
- Development Tools

13.4 Timerx/y Control Registers

REGISTER 13-1: TXCON: TIMER CONTROL REGISTER (X = 2 OR 4, Y = 3 OR 5)

R/W-0	U-0	R/W-0	U-0	U-0	U-0	U-0	U-0
TON	—	TSIDL	—	—	—	—	—
bit 15							bit 8

U-0	R/W-0	R/W-0	R/W-0	R/W-0	U-0	R/W-0	U-0
—	TGATE	TCKPS<1:0>		T32	—	TCS	—
bit 7							bit 0

Legend:

R = Readable bit W = Writable bit U = Unimplemented bit, read as '0'
 -n = Value at POR '1' = Bit is set '0' = Bit is cleared x = Bit is unknown

- bit 15 **TON:** Timerx On bit
 When T32 = 1 (in 32-bit Timer mode):
 1 = Starts 32-bit TMRx:TMRy timer pair
 0 = Stops 32-bit TMRx:TMRy timer pair
 When T32 = 0 (in 16-bit Timer mode):
 1 = Starts 16-bit timer
 0 = Stops 16-bit timer
- bit 14 **Unimplemented:** Read as '0'
- bit 13 **TSIDL:** Stop in Idle Mode bit
 1 = Discontinue timer operation when device enters Idle mode
 0 = Continue timer operation in Idle mode
- bit 12-7 **Unimplemented:** Read as '0'
- bit 6 **TGATE:** Timerx Gated Time Accumulation Enable bit
 When TCS = 1:
 This bit is ignored.
 When TCS = 0:
 1 = Gated time accumulation enabled
 0 = Gated time accumulation disabled
- bit 5-4 **TCKPS<1:0>:** Timerx Input Clock Prescale Select bits
 11 = 1:256 prescale value
 10 = 1:64 prescale value
 01 = 1:8 prescale value
 00 = 1:1 prescale value
- bit 3 **T32:** 32-bit Timerx Mode Select bit
 1 = TMRx and TMRy form a 32-bit timer
 0 = TMRx and TMRy form separate 16-bit timer
- bit 2 **Unimplemented:** Read as '0'
- bit 1 **TCS:** Timerx Clock Source Select bit
 1 = External clock from TxCK pin
 0 = Internal clock (FOSC/2)
- bit 0 **Unimplemented:** Read as '0'

REGISTER 13-2: TxCON: TIMER CONTROL REGISTER (x = 3 OR 5)

R/W-0	U-0	R/W-0	U-0	U-0	U-0	U-0	U-0
TON ⁽²⁾	—	TSIDL ⁽¹⁾	—	—	—	—	—
bit 15							bit 8

U-0	R/W-0	R/W-0	R/W-0	U-0	U-0	R/W-0	U-0
—	TGATE ⁽²⁾	TCKPS<1:0> ⁽²⁾		—	—	TCS ⁽²⁾	—
bit 7							bit 0

Legend:			
R = Readable bit	W = Writable bit	U = Unimplemented bit, read as '0'	
-n = Value at POR	'1' = Bit is set	'0' = Bit is cleared	x = Bit is unknown

- bit 15 **TON:** Timery On bit⁽²⁾
 1 = Starts 16-bit Timerx
 0 = Stops 16-bit Timerx
- bit 14 **Unimplemented:** Read as '0'
- bit 13 **TSIDL:** Stop in Idle Mode bit⁽¹⁾
 1 = Discontinue timer operation when device enters Idle mode
 0 = Continue timer operation in Idle mode
- bit 12-7 **Unimplemented:** Read as '0'
- bit 6 **TGATE:** Timerx Gated Time Accumulation Enable bit⁽²⁾
 When TCS = 1:
 This bit is ignored.
 When TCS = 0:
 1 = Gated time accumulation enabled
 0 = Gated time accumulation disabled
- bit 5-4 **TCKPS<1:0>:** Timerx Input Clock Prescale Select bits⁽²⁾
 11 = 1:256 prescale value
 10 = 1:64 prescale value
 01 = 1:8 prescale value
 00 = 1:1 prescale value
- bit 3-2 **Unimplemented:** Read as '0'
- bit 1 **TCS:** Timerx Clock Source Select bit⁽²⁾
 1 = External clock from TxCK pin
 0 = Internal clock (Fosc/2)
- bit 0 **Unimplemented:** Read as '0'

- Note 1:** When 32-bit timer operation is enabled (T32 = 1) in the Timer Control register (TxCON<3>), the TSIDL bit must be cleared to operate the 32-bit timer in Idle mode.
- 2:** When the 32-bit timer operation is enabled (T32 = 1) in the Timer Control register (TxCON<3>), these bits have no effect.

NOTES:

14.0 INPUT CAPTURE

Note 1: This data sheet summarizes the features of the PIC24HJ32GP302/304, PIC24HJ64GPX02/X04 and PIC24HJ128GPX02/X04 families of devices. It is not intended to be a comprehensive reference source. To complement the information in this data sheet, refer to **Section 12. "Input Capture"** (DS70198) of the "dsPIC33F/PIC24H Family Reference Manual", which is available from the Microchip web site (www.microchip.com).

2: Some registers and associated bits described in this section may not be available on all devices. Refer to **Section 4.0 "Memory Organization"** in this data sheet for device-specific register and bit information.

The input capture module is useful in applications requiring frequency (period) and pulse measurement. The PIC24HJ32GP302/304, PIC24HJ64GPX02/X04 and PIC24HJ128GPX02/X04 devices support up to four input capture channels.

The input capture module captures the 16-bit value of the selected Time Base register when an event occurs at the ICx pin. The events that cause a capture event are listed below in three categories:

- Simple Capture Event modes:
 - Capture timer value on every falling edge of input at ICx pin
 - Capture timer value on every rising edge of input at ICx pin
- Capture timer value on every edge (rising and falling)
- Prescaler Capture Event modes:
 - Capture timer value on every 4th rising edge of input at ICx pin
 - Capture timer value on every 16th rising edge of input at ICx pin

Each input capture channel can select one of two 16-bit timers (Timer2 or Timer3) for the time base. The selected timer can use either an internal or external clock.

Other operational features include:

- Device wake-up from capture pin during CPU Sleep and Idle modes
- Interrupt on input capture event
- 4-word FIFO buffer for capture values:
 - Interrupt optionally generated after 1, 2, 3 or 4 buffer locations are filled
- Use of input capture to provide additional sources of external interrupts

Note: Only IC1 and IC2 can trigger a DMA data transfer. If DMA data transfers are required, the FIFO buffer size must be set to '1' (IC1<1:0> = 00).

FIGURE 14-1: INPUT CAPTURE BLOCK DIAGRAM



14.1 Input Capture Resources

Many useful resources related to Input Capture are provided on the main product page of the Microchip web site for the devices listed in this data sheet. This product page, which can be accessed using this [link](#), contains the latest updates and additional information.

<p>Note: In the event you are not able to access the product page using the link above, enter this URL in your browser: http://www.microchip.com/wwwproducts/Devices.aspx?dDocName=en532315</p>
--

14.1.1 KEY RESOURCES

- **Section 12. “Input Capture”** (DS70198)
- Code Samples
- Application Notes
- Software Libraries
- Webinars
- All related dsPIC33F/PIC24H Family Reference Manuals Sections
- Development Tools

14.2 Input Capture Registers

REGISTER 14-1: ICxCON: INPUT CAPTURE x CONTROL REGISTER (x = 1, 2, 7 OR 8)

U-0	U-0	R/W-0	U-0	U-0	U-0	U-0	U-0
—	—	ICSIDL	—	—	—	—	—
bit 15							bit 8

R/W-0	R/W-0	R/W-0	R-0, HC	R-0, HC	R/W-0	R/W-0	R/W-0
ICTMR	ICI<1:0>	ICOV	ICBNE	ICM<2:0>	ICM<2:0>	ICM<2:0>	ICM<2:0>
bit 7							bit 0

Legend:	HC = Cleared in Hardware
R = Readable bit	W = Writable bit U = Unimplemented bit, read as '0'
-n = Value at POR	'1' = Bit is set '0' = Bit is cleared x = Bit is unknown

- bit 15-14 **Unimplemented:** Read as '0'
- bit 13 **ICSIDL:** Input Capture Module Stop in Idle Control bit
 - 1 = Input capture module halts in CPU Idle mode
 - 0 = Input capture module continues to operate in CPU Idle mode
- bit 12-8 **Unimplemented:** Read as '0'
- bit 7 **ICTMR:** Input Capture Timer Select bits
 - 1 = TMR2 contents are captured on capture event
 - 0 = TMR3 contents are captured on capture event
- bit 6-5 **ICI<1:0>:** Select Number of Captures per Interrupt bits
 - 11 = Interrupt on every fourth capture event
 - 10 = Interrupt on every third capture event
 - 01 = Interrupt on every second capture event
 - 00 = Interrupt on every capture event
- bit 4 **ICOV:** Input Capture Overflow Status Flag bit (read-only)
 - 1 = Input capture overflow occurred
 - 0 = No input capture overflow occurred
- bit 3 **ICBNE:** Input Capture Buffer Empty Status bit (read-only)
 - 1 = Input capture buffer is not empty, at least one more capture value can be read
 - 0 = Input capture buffer is empty
- bit 2-0 **ICM<2:0>:** Input Capture Mode Select bits
 - 111 = Input capture functions as interrupt pin only when device is in Sleep or Idle mode
(Rising edge detect only, all other control bits are not applicable)
 - 110 = Unused (module disabled)
 - 101 = Capture mode, every 16th rising edge
 - 100 = Capture mode, every 4th rising edge
 - 011 = Capture mode, every rising edge
 - 010 = Capture mode, every falling edge
 - 001 = Capture mode, every edge (rising and falling)
(ICI<1:0> bits do not control interrupt generation for this mode)
 - 000 = Input capture module turned off

NOTES:

15.1 Output Compare Modes

Configure the Output Compare modes by setting the appropriate Output Compare Mode bits (OCM<2:0>) in the Output Compare Control register (OCxCON<2:0>). Table 15-1 lists the different bit settings for the Output Compare modes. Figure 15-2 illustrates the output compare operation for various modes. The user application must disable the associated timer when writing to the output compare control registers to avoid malfunctions.

Note 1: Only OC1 and OC2 can trigger a DMA data transfer.

2: See Section 13. “Output Compare” (DS70209) in the “dsPIC33F/PIC24H Family Reference Manual” for OCxR and OCxRS register restrictions.

TABLE 15-1: OUTPUT COMPARE MODES

OCM<2:0>	Mode	OCx Pin Initial State	OCx Interrupt Generation
000	Module Disabled	Controlled by GPIO register	—
001	Active-Low One-Shot	0	OCx Rising edge
010	Active-High One-Shot	1	OCx Falling edge
011	Toggle Mode	Current output is maintained	OCx Rising and Falling edge
100	Delayed One-Shot	0	OCx Falling edge
101	Continuous Pulse mode	0	OCx Falling edge
110	PWM mode without fault protection	0, if OCxR is zero 1, if OCxR is non-zero	No interrupt
111	PWM mode with fault protection	0, if OCxR is zero 1, if OCxR is non-zero	OCFA Falling edge for OC1 to OC4

FIGURE 15-2: OUTPUT COMPARE OPERATION



15.2 Output Compare Resources

Many useful resources related to Output Compare are provided on the main product page of the Microchip web site for the devices listed in this data sheet. This product page, which can be accessed using this [link](#), contains the latest updates and additional information.

Note: In the event you are not able to access the product page using the link above, enter this URL in your browser:
<http://www.microchip.com/wwwproducts/Devices.aspx?dDocName=en532315>

15.2.1 KEY RESOURCES

- **Section 13. “Output Compare”** (DS70209)
- Code Samples
- Application Notes
- Software Libraries
- Webinars
- All related dsPIC33F/PIC24H Family Reference Manuals Sections
- Development Tools

15.3 Output Compare Control Registers

REGISTER 15-1: OCxCON: OUTPUT COMPAREx CONTROL REGISTER (x = 1, 2, 3 OR 4)

U-0	U-0	R/W-0	U-0	U-0	U-0	U-0	U-0
—	—	OCSIDL	—	—	—	—	—
bit 15						bit 8	

U-0	U-0	U-0	R-0 HC	R/W-0	R/W-0	R/W-0	R/W-0
—	—	—	OCFLT	OCTSEL	OCM<2:0>		
bit 7						bit 0	

Legend:	HC = Cleared in Hardware	HS = Set in Hardware
R = Readable bit	W = Writable bit	U = Unimplemented bit, read as '0'
-n = Value at POR	'1' = Bit is set	'0' = Bit is cleared x = Bit is unknown

- bit 15-14 **Unimplemented:** Read as '0'
- bit 13 **OCSIDL:** Stop Output Compare in Idle Mode Control bit
 - 1 = Output Compare x halts in CPU Idle mode
 - 0 = Output Compare x continues to operate in CPU Idle mode
- bit 12-5 **Unimplemented:** Read as '0'
- bit 4 **OCFLT:** PWM Fault Condition Status bit
 - 1 = PWM Fault condition has occurred (cleared in hardware only)
 - 0 = No PWM Fault condition has occurred
 - (This bit is only used when OCM<2:0> = 111)
- bit 3 **OCTSEL:** Output Compare Timer Select bit
 - 1 = Timer3 is the clock source for Compare x
 - 0 = Timer2 is the clock source for Compare x
- bit 2-0 **OCM<2:0>:** Output Compare Mode Select bits
 - 111 = PWM mode on OCx, Fault pin enabled
 - 110 = PWM mode on OCx, Fault pin disabled
 - 101 = Initialize OCx pin low, generate continuous output pulses on OCx pin
 - 100 = Initialize OCx pin low, generate single output pulse on OCx pin
 - 011 = Compare event toggles OCx pin
 - 010 = Initialize OCx pin high, compare event forces OCx pin low
 - 001 = Initialize OCx pin low, compare event forces OCx pin high
 - 000 = Output compare channel is disabled

16.0 SERIAL PERIPHERAL INTERFACE (SPI)

Note 1: This data sheet summarizes the features of the PIC24HJ32GP302/304, PIC24HJ64GPX02/X04 and PIC24HJ128GPX02/X04 families of devices. It is not intended to be a comprehensive reference source. To complement the information in this data sheet, refer to **Section 18. “Serial Peripheral Interface (SPI)”** (DS70206) of the “dsPIC33F/PIC24H Family Reference Manual”, which is available from the Microchip web site (www.microchip.com).

2: Some registers and associated bits described in this section may not be available on all devices. Refer to **Section 4.0 “Memory Organization”** in this data sheet for device-specific register and bit information.

The Serial Peripheral Interface (SPI) module is a synchronous serial interface useful for communicating with other peripheral or microcontroller devices. These peripheral devices can be serial EEPROMs, shift registers, display drivers, analog-to-digital converters, etc. The SPI module is compatible with Motorola® SPI and SIOP.

Each SPI module consists of a 16-bit shift register, SPIxSR (where x = 1 or 2), used for shifting data in and out, and a buffer register, SPIxBUF. A control register, SPIxCON, configures the module. Additionally, a status register, SPIxSTAT, indicates status conditions.

The serial interface consists of 4 pins:

- SDIx (serial data input)
- SDOx (serial data output)
- SCKx (shift clock input or output)
- SSx (active-low slave select)

In Master mode operation, SCK is a clock output. In Slave mode, it is a clock input.

FIGURE 16-1: SPI MODULE BLOCK DIAGRAM



16.1 SPI Helpful Tips

1. In Frame mode, if there is a possibility that the master may not be initialized before the slave:
 - a) If FRMPOL (SPIxCON2<13>) = 1, use a pull-down resistor on SSx.
 - b) If FRMPOL = 0, use a pull-up resistor on SSx.

Note: This insures that the first frame transmission after initialization is not shifted or corrupted.

2. In non-framed 3-wire mode, (i.e., not using SSx from a master):
 - a) If CKP (SPIxCON1<6>) = 1, always place a pull-up resistor on SSx.
 - b) If CKP = 0, always place a pull-down resistor on SSx.

Note: This will insure that during power-up and initialization the master/slave will not lose sync due to an errant SCK transition that would cause the slave to accumulate data shift errors for both transmit and receive appearing as corrupted data.

3. FRMEN (SPIxCON2<15>) = 1 and SSEN (SPIxCON1<7>) = 1 are exclusive and invalid. In Frame mode, SCKx is continuous and the Frame sync pulse is active on the SSx pin, which indicates the start of a data frame.

Note: Not all third-party devices support Frame mode timing. Refer to the SPI electrical characteristics for details.

4. In Master mode only, set the SMP bit (SPIxCON1<9>) to a '1' for the fastest SPI data rate possible. The SMP bit can only be set at the same time or after the MSTEN bit (SPIxCON1<5>) is set.
5. To avoid invalid slave read data to the master, the user's master software must guarantee enough time for slave software to fill its write buffer before the user application initiates a master write/read cycle. It is always advisable to preload the SPIxBUF transmit register in advance of the next master transaction cycle. SPIxBUF is transferred to the SPI shift register and is empty once the data transmission begins.

16.2 SPI Resources

Many useful resources related to SPI are provided on the main product page of the Microchip web site for the devices listed in this data sheet. This product page, which can be accessed using this [link](#), contains the latest updates and additional information.

Note: In the event you are not able to access the product page using the link above, enter this URL in your browser:
<http://www.microchip.com/wwwproducts/Devices.aspx?dDocName=en532315>

16.2.1 KEY RESOURCES

- **Section 18. "Serial Peripheral Interface (SPI)" (DS70206)**
- Code Samples
- Application Notes
- Software Libraries
- Webinars
- All related dsPIC33F/PIC24H Family Reference Manuals Sections
- Development Tools

16.3 SPI Registers

REGISTER 16-1: SPIxSTAT: SPIx STATUS AND CONTROL REGISTER

R/W-0	U-0	R/W-0	U-0	U-0	U-0	U-0	U-0
SPIEN	—	SPISIDL	—	—	—	—	—
bit 15							bit 8

U-0	R/C-0	U-0	U-0	U-0	U-0	R-0	R-0
—	SPIROV	—	—	—	—	SPITBF	SPIRBF
bit 7							bit 0

Legend:	C = Clearable bit		
R = Readable bit	W = Writable bit	U = Unimplemented bit, read as '0'	
-n = Value at POR	'1' = Bit is set	'0' = Bit is cleared	x = Bit is unknown

- bit 15 **SPIEN:** SPIx Enable bit
 1 = Enables module and configures SCKx, SDOx, SDIx and \overline{SSx} as serial port pins
 0 = Disables module
- bit 14 **Unimplemented:** Read as '0'
- bit 13 **SPISIDL:** Stop in Idle Mode bit
 1 = Discontinue module operation when device enters Idle mode
 0 = Continue module operation in Idle mode
- bit 12-7 **Unimplemented:** Read as '0'
- bit 6 **SPIROV:** Receive Overflow Flag bit
 1 = A new byte/word is completely received and discarded. The user software has not read the previous data in the SPIxBUF register
 0 = No overflow has occurred.
- bit 5-2 **Unimplemented:** Read as '0'
- bit 1 **SPITBF:** SPIx Transmit Buffer Full Status bit
 1 = Transmit not yet started, SPIxTXB is full
 0 = Transmit started, SPIxTXB is empty
 Automatically set in hardware when CPU writes SPIxBUF location, loading SPIxTXB.
 Automatically cleared in hardware when SPIx module transfers data from SPIxTXB to SPIxSR.
- bit 0 **SPIRBF:** SPIx Receive Buffer Full Status bit
 1 = Receive complete, SPIxRXB is full
 0 = Receive is not complete, SPIxRXB is empty
 Automatically set in hardware when SPIx transfers data from SPIxSR to SPIxRXB.
 Automatically cleared in hardware when core reads SPIxBUF location, reading SPIxRXB.

PIC24HJ32GP302/304, PIC24HJ64GPX02/X04 AND PIC24HJ128GPX02/X04

REGISTER 16-2: SPIxCON1: SPIx CONTROL REGISTER 1

U-0	U-0	U-0	R/W-0	R/W-0	R/W-0	R/W-0	R/W-0
—	—	—	DISSCK	DISSDO	MODE16	SMP	CKE ⁽¹⁾
bit 15							bit 8

R/W-0	R/W-0	R/W-0	R/W-0	R/W-0	R/W-0	R/W-0	R/W-0
SSEN ⁽³⁾	CKP	MSTEN	SPRE<2:0> ⁽²⁾			PPRE<1:0> ⁽²⁾	
bit 7							bit 0

Legend:

R = Readable bit	W = Writable bit	U = Unimplemented bit, read as '0'
-n = Value at POR	'1' = Bit is set	'0' = Bit is cleared
		x = Bit is unknown

- bit 15-13 **Unimplemented:** Read as '0'
- bit 12 **DISSCK:** Disable SCKx pin bit (SPI Master modes only)
 1 = Internal SPI clock is disabled, pin functions as I/O
 0 = Internal SPI clock is enabled
- bit 11 **DISSDO:** Disable SDOx pin bit
 1 = SDOx pin is not used by module; pin functions as I/O
 0 = SDOx pin is controlled by the module
- bit 10 **MODE16:** Word/Byte Communication Select bit
 1 = Communication is word-wide (16 bits)
 0 = Communication is byte-wide (8 bits)
- bit 9 **SMP:** SPIx Data Input Sample Phase bit
Master mode:
 1 = Input data sampled at end of data output time
 0 = Input data sampled at middle of data output time
Slave mode:
 SMP must be cleared when SPIx is used in Slave mode.
- bit 8 **CKE:** SPIx Clock Edge Select bit⁽¹⁾
 1 = Serial output data changes on transition from active clock state to Idle clock state (see bit 6)
 0 = Serial output data changes on transition from Idle clock state to active clock state (see bit 6)
- bit 7 **SSEN:** Slave Select Enable bit (Slave mode)⁽³⁾
 1 = SSx pin used for Slave mode
 0 = SSx pin not used by module. Pin controlled by port function
- bit 6 **CKP:** Clock Polarity Select bit
 1 = Idle state for clock is a high level; active state is a low level
 0 = Idle state for clock is a low level; active state is a high level
- bit 5 **MSTEN:** Master Mode Enable bit
 1 = Master mode
 0 = Slave mode

Note 1: The CKE bit is not used in the Framed SPI modes. Program this bit to '0' for the Framed SPI modes (FRMEN = 1).

2: Do not set both Primary and Secondary prescalers to a value of 1:1.

3: This bit must be cleared when FRMEN = 1.

REGISTER 16-2: SPIxCON1: SPIx CONTROL REGISTER 1 (CONTINUED)

- bit 4-2 **SPRE<2:0>**: Secondary Prescale bits (Master mode)⁽²⁾
111 = Secondary prescale 1:1
110 = Secondary prescale 2:1
•
•
•
000 = Secondary prescale 8:1
- bit 1-0 **PPRE<1:0>**: Primary Prescale bits (Master mode)⁽²⁾
11 = Primary prescale 1:1
10 = Primary prescale 4:1
01 = Primary prescale 16:1
00 = Primary prescale 64:1

- Note 1:** The CKE bit is not used in the Framed SPI modes. Program this bit to '0' for the Framed SPI modes (FRMEN = 1).
- 2:** Do not set both Primary and Secondary prescalers to a value of 1:1.
- 3:** This bit must be cleared when FRMEN = 1.

PIC24HJ32GP302/304, PIC24HJ64GPX02/X04 AND PIC24HJ128GPX02/X04

REGISTER 16-3: SPIxCON2: SPIx CONTROL REGISTER 2

R/W-0	R/W-0	R/W-0	U-0	U-0	U-0	U-0	U-0
FRMEN	SPIFSD	FRMPOL	—	—	—	—	—
bit 15						bit 8	
U-0	U-0	U-0	U-0	U-0	U-0	R/W-0	U-0
—	—	—	—	—	—	FRMDLY	—
bit 7						bit 0	

Legend:

R = Readable bit	W = Writable bit	U = Unimplemented bit, read as '0'
-n = Value at POR	'1' = Bit is set	'0' = Bit is cleared
		x = Bit is unknown

- bit 15 **FRMEN:** Framed SPIx Support bit
 1 = Framed SPIx support enabled (\overline{SSx} pin used as frame sync pulse input/output)
 0 = Framed SPIx support disabled
- bit 14 **SPIFSD:** Frame Sync Pulse Direction Control bit
 1 = Frame sync pulse input (slave)
 0 = Frame sync pulse output (master)
- bit 13 **FRMPOL:** Frame Sync Pulse Polarity bit
 1 = Frame sync pulse is active-high
 0 = Frame sync pulse is active-low
- bit 12-2 **Unimplemented:** Read as '0'
- bit 1 **FRMDLY:** Frame Sync Pulse Edge Select bit
 1 = Frame sync pulse coincides with first bit clock
 0 = Frame sync pulse precedes first bit clock
- bit 0 **Unimplemented:** This bit must not be set to '1' by the user application

17.0 INTER-INTEGRATED CIRCUIT™ (I²C™)

Note 1: This data sheet summarizes the features of the PIC24HJ32GP302/304, PIC24HJ64GPX02/X04 and PIC24HJ128GPX02/X04 families of devices. It is not intended to be a comprehensive reference source. To complement the information in this data sheet, refer to **Section 19. “Inter-Integrated Circuit™ (I²C™)”** (DS70195) of the “*dsPIC33F/PIC24H Family Reference Manual*”, which is available from the Microchip web site (www.microchip.com).

2: Some registers and associated bits described in this section may not be available on all devices. Refer to **Section 4.0 “Memory Organization”** in this data sheet for device-specific register and bit information.

The Inter-Integrated Circuit (I²C) module provides complete hardware support for both Slave and Multi-Master modes of the I²C serial communication standard, with a 16-bit interface.

The I²C module has a 2-pin interface:

- The SCLx pin is clock.
- The SDAx pin is data.

The I²C module offers the following key features:

- I²C interface supporting both Master and Slave modes of operation.
- I²C Slave mode supports 7-bit and 10-bit addressing
- I²C Master mode supports 7-bit and 10-bit addressing
- I²C port allows bidirectional transfers between master and slaves
- Serial clock synchronization for I²C port can be used as a handshake mechanism to suspend and resume serial transfer (SCLREL control)
- I²C supports multi-master operation, detects bus collision and arbitrates accordingly

17.1 Operating Modes

The hardware fully implements all the master and slave functions of the I²C Standard and Fast mode specifications, as well as 7-bit and 10-bit addressing.

The I²C module can operate either as a slave or a master on an I²C bus.

The following types of I²C operation are supported:

- I²C slave operation with 7-bit addressing
- I²C slave operation with 10-bit addressing
- I²C master operation with 7-bit or 10-bit addressing

For details about the communication sequence in each of these modes, refer to the “*dsPIC33F/PIC24H Family Reference Manual*”. Please see the Microchip web site (www.microchip.com) for the latest dsPIC33F/PIC24H Family Reference Manual chapters.

FIGURE 17-1: I²C™ BLOCK DIAGRAM (x = 1)



17.2 I²C Resources

Many useful resources related to I²C are provided on the main product page of the Microchip web site for the devices listed in this data sheet. This product page, which can be accessed using this [link](#), contains the latest updates and additional information.

Note: In the event you are not able to access the product page using the link above, enter this URL in your browser:
<http://www.microchip.com/wwwproducts/Devices.aspx?dDoc-Name=en532315>

17.2.1 KEY RESOURCES

- **Section 19. “Inter-Integrated Circuit™ (I²C™)”** (DS70195)
- Code Samples
- Application Notes
- Software Libraries
- Webinars
- All related dsPIC33F/PIC24H Family Reference Manuals Sections
- Development Tools

17.3 I²C Registers

I2CxCON and I2CxSTAT are control and status registers, respectively. The I2CxCON register is readable and writable. The lower six bits of I2CxSTAT are read-only. The remaining bits of the I2CxSTAT are read/write:

- I2CxRSR is the shift register used for shifting data internal to the module and the user application has no access to it
- I2CxRCV is the receive buffer and the register to which data bytes are written, or from which data bytes are read
- I2CxTRN is the transmit register to which bytes are written during a transmit operation
- The I2CxADD register holds the slave address
- A status bit, ADD10, indicates 10-bit Address mode
- The I2CxBRG acts as the Baud Rate Generator (BRG) reload value

In receive operations, I2CxRSR and I2CxRCV together form a double-buffered receiver. When I2CxRSR receives a complete byte, it is transferred to I2CxRCV, and an interrupt pulse is generated.

PIC24HJ32GP302/304, PIC24HJ64GPX02/X04 AND PIC24HJ128GPX02/X04

REGISTER 17-1: I2CxCON: I2Cx CONTROL REGISTER

R/W-0	U-0	R/W-0	R/W-1 HC	R/W-0	R/W-0	R/W-0	R/W-0
I2CEN	—	I2CSIDL	SCLREL	IPMIEN	A10M	DISSLW	SMEN
bit 15						bit 8	

R/W-0	R/W-0	R/W-0	R/W-0 HC	R/W-0 HC	R/W-0 HC	R/W-0 HC	R/W-0 HC
GCEN	STREN	ACKDT	ACKEN	RCEN	PEN	RSEN	SEN
bit 7						bit 0	

Legend:	U = Unimplemented bit, read as '0'		
R = Readable bit	W = Writable bit	HS = Set in hardware	HC = Cleared in hardware
-n = Value at POR	'1' = Bit is set	'0' = Bit is cleared	x = Bit is unknown

- bit 15 **I2CEN:** I2Cx Enable bit
 1 = Enables the I2Cx module and configures the SDAx and SCLx pins as serial port pins
 0 = Disables the I2Cx module. All I²C pins are controlled by port functions
- bit 14 **Unimplemented:** Read as '0'
- bit 13 **I2CSIDL:** Stop in Idle Mode bit
 1 = Discontinue module operation when device enters an Idle mode
 0 = Continue module operation in Idle mode
- bit 12 **SCLREL:** SCLx Release Control bit (when operating as I²C slave)
 1 = Release SCLx clock
 0 = Hold SCLx clock low (clock stretch)
If STREN = 1:
 Bit is R/W (i.e., software can write '0' to initiate stretch and write '1' to release clock). Hardware clear at beginning of slave transmission. Hardware clear at end of slave reception.
If STREN = 0:
 Bit is R/S (i.e., software can only write '1' to release clock). Hardware clear at beginning of slave transmission.
- bit 11 **IPMIEN:** Intelligent Peripheral Management Interface (IPMI) Enable bit
 1 = IPMI mode is enabled; all addresses Acknowledged
 0 = IPMI mode disabled
- bit 10 **A10M:** 10-bit Slave Address bit
 1 = I2CxADD is a 10-bit slave address
 0 = I2CxADD is a 7-bit slave address
- bit 9 **DISSLW:** Disable Slew Rate Control bit
 1 = Slew rate control disabled
 0 = Slew rate control enabled
- bit 8 **SMEN:** SMBus Input Levels bit
 1 = Enable I/O pin thresholds compliant with SMBus specification
 0 = Disable SMBus input thresholds
- bit 7 **GCEN:** General Call Enable bit (when operating as I²C slave)
 1 = Enable interrupt when a general call address is received in the I2CxRSR (module is enabled for reception)
 0 = General call address disabled
- bit 6 **STREN:** SCLx Clock Stretch Enable bit (when operating as I²C slave)
 Used in conjunction with SCLREL bit.
 1 = Enable software or receive clock stretching
 0 = Disable software or receive clock stretching

REGISTER 17-1: I2CxCON: I2Cx CONTROL REGISTER (CONTINUED)

- bit 5 **ACKDT:** Acknowledge Data bit (when operating as I²C master, applicable during master receive)
Value that is transmitted when the software initiates an Acknowledge sequence.
1 = Send NACK during Acknowledge
0 = Send ACK during Acknowledge
- bit 4 **ACKEN:** Acknowledge Sequence Enable bit
(when operating as I²C master, applicable during master receive)
1 = Initiate Acknowledge sequence on SDAx and SCLx pins and transmit ACKDT data bit.
Hardware clear at end of master Acknowledge sequence
0 = Acknowledge sequence not in progress
- bit 3 **RCEN:** Receive Enable bit (when operating as I²C master)
1 = Enables Receive mode for I²C. Hardware clear at end of eighth bit of master receive data byte
0 = Receive sequence not in progress
- bit 2 **PEN:** Stop Condition Enable bit (when operating as I²C master)
1 = Initiate Stop condition on SDAx and SCLx pins. Hardware clear at end of master Stop sequence
0 = Stop condition not in progress
- bit 1 **RSEN:** Repeated Start Condition Enable bit (when operating as I²C master)
1 = Initiate Repeated Start condition on SDAx and SCLx pins. Hardware clear at end of
master Repeated Start sequence
0 = Repeated Start condition not in progress
- bit 0 **SEN:** Start Condition Enable bit (when operating as I²C master)
1 = Initiate Start condition on SDAx and SCLx pins. Hardware clear at end of master Start sequence
0 = Start condition not in progress

PIC24HJ32GP302/304, PIC24HJ64GPX02/X04 AND PIC24HJ128GPX02/X04

REGISTER 17-2: I2CxSTAT: I2Cx STATUS REGISTER

R-0 HSC	R-0 HSC	U-0	U-0	U-0	R/C-0 HS	R-0 HSC	R-0 HSC
ACKSTAT	TRSTAT	—	—	—	BCL	GCSTAT	ADD10
bit 15						bit 8	

R/C-0 HS	R/C-0 HS	R-0 HSC	R/C-0 HSC	R/C-0 HSC	R-0 HSC	R-0 HSC	R-0 HSC
IWCOL	I2COV	D_A	P	S	R_W	RBF	TBF
bit 7						bit 0	

Legend:	U = Unimplemented bit, read as '0'	C = Clear only bit
R = Readable bit	W = Writable bit	HS = Set in hardware
-n = Value at POR	'1' = Bit is set	'0' = Bit is cleared
		x = Bit is unknown

- bit 15 **ACKSTAT:** Acknowledge Status bit
(when operating as I²C™ master, applicable to master transmit operation)
1 = NACK received from slave
0 = ACK received from slave
Hardware set or clear at end of slave Acknowledge.
- bit 14 **TRSTAT:** Transmit Status bit (when operating as I²C master, applicable to master transmit operation)
1 = Master transmit is in progress (8 bits + ACK)
0 = Master transmit is not in progress
Hardware set at beginning of master transmission. Hardware clear at end of slave Acknowledge.
- bit 13-11 **Unimplemented:** Read as '0'
- bit 10 **BCL:** Master Bus Collision Detect bit
1 = A bus collision has been detected during a master operation
0 = No collision
Hardware set at detection of bus collision.
- bit 9 **GCSTAT:** General Call Status bit
1 = General call address was received
0 = General call address was not received
Hardware set when address matches general call address. Hardware clear at Stop detection.
- bit 8 **ADD10:** 10-bit Address Status bit
1 = 10-bit address was matched
0 = 10-bit address was not matched
Hardware set at match of 2nd byte of matched 10-bit address. Hardware clear at Stop detection.
- bit 7 **IWCOL:** Write Collision Detect bit
1 = An attempt to write the I2CxTRN register failed because the I²C module is busy
0 = No collision
Hardware set at occurrence of write to I2CxTRN while busy (cleared by software).
- bit 6 **I2COV:** Receive Overflow Flag bit
1 = A byte was received while the I2CxRCV register is still holding the previous byte
0 = No overflow
Hardware set at attempt to transfer I2CxRSR to I2CxRCV (cleared by software).
- bit 5 **D_A:** Data/Address bit (when operating as I²C slave)
1 = Indicates that the last byte received was data
0 = Indicates that the last byte received was device address
Hardware clear at device address match. Hardware set by reception of slave byte.
- bit 4 **P:** Stop bit
1 = Indicates that a Stop bit has been detected last
0 = Stop bit was not detected last
Hardware set or clear when Start, Repeated Start or Stop detected.

REGISTER 17-2: I2CxSTAT: I2Cx STATUS REGISTER (CONTINUED)

- bit 3 **S:** Start bit
1 = Indicates that a Start (or Repeated Start) bit has been detected last
0 = Start bit was not detected last
Hardware set or clear when Start, Repeated Start or Stop detected.
- bit 2 **R_W:** Read/Write Information bit (when operating as I²C slave)
1 = Read – indicates data transfer is output from slave
0 = Write – indicates data transfer is input to slave
Hardware set or clear after reception of I²C device address byte.
- bit 1 **RBF:** Receive Buffer Full Status bit
1 = Receive complete, I2CxRCV is full
0 = Receive not complete, I2CxRCV is empty
Hardware set when I2CxRCV is written with received byte. Hardware clear when software reads I2CxRCV.
- bit 0 **TBF:** Transmit Buffer Full Status bit
1 = Transmit in progress, I2CxTRN is full
0 = Transmit complete, I2CxTRN is empty
Hardware set when software writes I2CxTRN. Hardware clear at completion of data transmission.

PIC24HJ32GP302/304, PIC24HJ64GPX02/X04 AND PIC24HJ128GPX02/X04

REGISTER 17-3: I2CxMSK: I2Cx SLAVE MODE ADDRESS MASK REGISTER

U-0	U-0	U-0	U-0	U-0	U-0	R/W-0	R/W-0
—	—	—	—	—	—	AMSK9	AMSK8
bit 15						bit 8	

R/W-0	R/W-0	R/W-0	R/W-0	R/W-0	R/W-0	R/W-0	R/W-0
AMSK7	AMSK6	AMSK5	AMSK4	AMSK3	AMSK2	AMSK1	AMSK0
bit 7						bit 0	

Legend:

R = Readable bit

W = Writable bit

U = Unimplemented bit, read as '0'

-n = Value at POR

'1' = Bit is set

'0' = Bit is cleared

x = Bit is unknown

bit 15-10 **Unimplemented:** Read as '0'

bit 9-0 **AMSKx:** Mask for Address bit x Select bit

1 = Enable masking for bit x of incoming message address; bit match not required in this position

0 = Disable masking for bit x; bit match required in this position

18.0 UNIVERSAL ASYNCHRONOUS RECEIVER TRANSMITTER (UART)

Note 1: This data sheet summarizes the features of the PIC24HJ32GP302/304, PIC24HJ64GPX02/X04 and PIC24HJ128GPX02/X04 families of devices. It is not intended to be a comprehensive reference source. To complement the information in this data sheet, refer to **Section 17. "UART"** (DS70188) of the "dsPIC33F/PIC24H Family Reference Manual", which is available from the Microchip web site (www.microchip.com).

2: Some registers and associated bits described in this section may not be available on all devices. Refer to **Section 4.0 "Memory Organization"** in this data sheet for device-specific register and bit information.

The Universal Asynchronous Receiver Transmitter (UART) module is one of the serial I/O modules available in the PIC24HJ32GP302/304, PIC24HJ64GPX02/X04 and PIC24HJ128GPX02/X04 device family. The UART is a full-duplex asynchronous system that can communicate with peripheral devices, such as personal computers, LIN 2.0, RS-232 and RS-485 interfaces. The module also supports a hardware flow control option with the UxCTS and UxRTS pins and also includes an IrDA® encoder and decoder.

The primary features of the UART module are:

- Full-Duplex, 8- or 9-bit Data Transmission through the UxTX and UxRX pins
- Even, Odd or No Parity Options (for 8-bit data)
- One or two stop bits
- Hardware flow control option with $\overline{\text{UxCTS}}$ and $\overline{\text{UxRTS}}$ pins
- Fully integrated Baud Rate Generator with 16-bit prescaler
- Baud rates ranging from 10 Mbps to 38 bps at 40 MIPS
- 4-deep First-In First-Out (FIFO) Transmit Data buffer
- 4-deep FIFO Receive Data buffer
- Parity, framing and buffer overrun error detection
- Support for 9-bit mode with Address Detect (9th bit = 1)
- Transmit and Receive interrupts
- A separate interrupt for all UART error conditions
- Loopback mode for diagnostic support
- Support for sync and break characters
- Support for automatic baud rate detection
- IrDA® encoder and decoder logic
- 16x baud clock output for IrDA® support

A simplified block diagram of the UART module is shown in **Figure 18-1**. The UART module consists of these key hardware elements:

- Baud Rate Generator
- Asynchronous Transmitter
- Asynchronous Receiver

FIGURE 18-1: UART SIMPLIFIED BLOCK DIAGRAM



Note 1: Both UART1 and UART2 can trigger a DMA data transfer.

2: If DMA transfers are required, the UART TX/RX FIFO buffer must be set to a size of 1 byte/word (i.e., UTXISEL<1:0> = 00 and URXISEL<1:0> = 00).

18.1 UART Helpful Tips

1. In multi-node direct-connect UART networks, UART receive inputs react to the complementary logic level defined by the URXINV bit (UxMODE<4>), which defines the idle state, the default of which is logic high, (i.e., URXINV = 0). Because remote devices do not initialize at the same time, it is likely that one of the devices, because the RX line is floating, will trigger a start bit detection and will cause the first byte received after the device has been initialized to be invalid. To avoid this situation, the user should use a pull-up or pull-down resistor on the RX pin depending on the value of the URXINV bit.
 - a) If URXINV = 0, use a pull-up resistor on the RX pin.
 - b) If URXINV = 1, use a pull-down resistor on the RX pin.
2. The first character received on a wake-up from Sleep mode caused by activity on the UxRX pin of the UART module will be invalid. In Sleep mode, peripheral clocks are disabled. By the time the oscillator system has restarted and stabilized from Sleep mode, the baud rate bit sampling clock relative to the incoming UxRX bit timing is no longer synchronized, resulting in the first character being invalid. This is to be expected.

18.2 UART Resources

Many useful resources related to UART are provided on the main product page of the Microchip web site for the devices listed in this data sheet. This product page, which can be accessed using this [link](#), contains the latest updates and additional information.

<p>Note: In the event you are not able to access the product page using the link above, enter this URL in your browser: http://www.microchip.com/wwwproducts/Devices.aspx?dDocName=en532315</p>
--

18.2.1 KEY RESOURCES

- **Section 17. “UART”** (DS70188)
- Code Samples
- Application Notes
- Software Libraries
- Webinars
- All related dsPIC33F/PIC24H Family Reference Manuals Sections
- Development Tools

18.3 UART Control Registers

REGISTER 18-1: UxMODE: UARTx MODE REGISTER

R/W-0	U-0	R/W-0	R/W-0	R/W-0	U-0	R/W-0	R/W-0
UARTEN ⁽¹⁾	—	USIDL	IREN ⁽²⁾	RTSMD	—	UEN<1:0>	
bit 15						bit 8	

R/W-0 HC	R/W-0	R/W-0 HC	R/W-0	R/W-0	R/W-0	R/W-0	R/W-0
WAKE	LPBACK	ABAUD	URXINV	BRGH	PDSEL<1:0>		STSEL
bit 7						bit 0	

Legend:	HC = Hardware cleared
R = Readable bit	W = Writable bit
-n = Value at POR	'1' = Bit is set
	U = Unimplemented bit, read as '0'
	'0' = Bit is cleared
	x = Bit is unknown

- bit 15 **UARTEN:** UARTx Enable bit⁽¹⁾
 1 = UARTx is enabled; all UARTx pins are controlled by UARTx as defined by UEN<1:0>
 0 = UARTx is disabled; all UARTx pins are controlled by port latches; UARTx power consumption minimal
- bit 14 **Unimplemented:** Read as '0'
- bit 13 **USIDL:** Stop in Idle Mode bit
 1 = Discontinue module operation when device enters Idle mode
 0 = Continue module operation in Idle mode
- bit 12 **IREN:** IrDA[®] Encoder and Decoder Enable bit⁽²⁾
 1 = IrDA encoder and decoder enabled
 0 = IrDA encoder and decoder disabled
- bit 11 **RTSMD:** Mode Selection for $\overline{\text{UxRTS}}$ Pin bit
 1 = $\overline{\text{UxRTS}}$ pin in Simplex mode
 0 = $\overline{\text{UxRTS}}$ pin in Flow Control mode
- bit 10 **Unimplemented:** Read as '0'
- bit 9-8 **UEN<1:0>:** UARTx Enable bits
 11 = UxTX, UxRX and BCLK pins are enabled and used; $\overline{\text{UxCTS}}$ pin controlled by port latches
 10 = UxTX, UxRX, $\overline{\text{UxCTS}}$ and $\overline{\text{UxRTS}}$ pins are enabled and used
 01 = UxTX, UxRX and $\overline{\text{UxRTS}}$ pins are enabled and used; $\overline{\text{UxCTS}}$ pin controlled by port latches
 00 = UxTX and UxRX pins are enabled and used; $\overline{\text{UxCTS}}$ and $\overline{\text{UxRTS}}$ /BCLK pins controlled by port latches
- bit 7 **WAKE:** Wake-up on Start bit Detect During Sleep Mode Enable bit
 1 = UARTx continues to sample the UxRX pin; interrupt generated on falling edge; bit cleared in hardware on following rising edge
 0 = No wake-up enabled
- bit 6 **LPBACK:** UARTx Loopback Mode Select bit
 1 = Enable Loopback mode
 0 = Loopback mode is disabled
- bit 5 **ABAUD:** Auto-Baud Enable bit
 1 = Enable baud rate measurement on the next character – requires reception of a Sync field (55h) before other data; cleared in hardware upon completion
 0 = Baud rate measurement disabled or completed

Note 1: Refer to **Section 17. “UART”** (DS70232) in the “*dsPIC33F/PIC24H Family Reference Manual*” for information on enabling the UART module for receive or transmit operation.

2: This feature is only available for the 16x BRG mode (BRGH = 0).

REGISTER 18-1: UxMODE: UARTx MODE REGISTER (CONTINUED)

- bit 4 **URXINV:** Receive Polarity Inversion bit
 1 = UxRX Idle state is '0'
 0 = UxRX Idle state is '1'
- bit 3 **BRGH:** High Baud Rate Enable bit
 1 = BRG generates 4 clocks per bit period (4x baud clock, High-Speed mode)
 0 = BRG generates 16 clocks per bit period (16x baud clock, Standard mode)
- bit 2-1 **PDSEL<1:0>:** Parity and Data Selection bits
 11 = 9-bit data, no parity
 10 = 8-bit data, odd parity
 01 = 8-bit data, even parity
 00 = 8-bit data, no parity
- bit 0 **STSEL:** Stop Bit Selection bit
 1 = Two Stop bits
 0 = One Stop bit

- Note 1:** Refer to **Section 17. "UART"** (DS70232) in the *"dsPIC33F/PIC24H Family Reference Manual"* for information on enabling the UART module for receive or transmit operation.
- 2:** This feature is only available for the 16x BRG mode (BRGH = 0).

REGISTER 18-2: UxSTA: UARTx STATUS AND CONTROL REGISTER

R/W-0	R/W-0	R/W-0	U-0	R/W-0 HC	R/W-0	R-0	R-1
UTXISEL1	UTXINV	UTXISEL0	—	UTXBRK	UTXEN ⁽¹⁾	UTXBF	TRMT
bit 15						bit 8	

R/W-0	R/W-0	R/W-0	R-1	R-0	R-0	R/C-0	R-0
URXISEL<1:0>		ADDEN	RIDLE	PERR	FERR	OERR	URXDA
bit 7						bit 0	

Legend:	HC = Hardware cleared	C = Clear only bit
R = Readable bit	W = Writable bit	U = Unimplemented bit, read as '0'
-n = Value at POR	'1' = Bit is set	'0' = Bit is cleared x = Bit is unknown

- bit 15,13 **UTXISEL<1:0>**: Transmission Interrupt Mode Selection bits
 11 = Reserved; do not use
 10 = Interrupt when a character is transferred to the Transmit Shift Register, and as a result, the transmit buffer becomes empty
 01 = Interrupt when the last character is shifted out of the Transmit Shift Register; all transmit operations are completed
 00 = Interrupt when a character is transferred to the Transmit Shift Register (this implies there is at least one character open in the transmit buffer)
- bit 14 **UTXINV**: Transmit Polarity Inversion bit
If IREN = 0:
 1 = UxTX Idle state is '0'
 0 = UxTX Idle state is '1'
If IREN = 1:
 1 = IrDA[®] encoded UxTX Idle state is '1'
 0 = IrDA[®] encoded UxTX Idle state is '0'
- bit 12 **Unimplemented**: Read as '0'
- bit 11 **UTXBRK**: Transmit Break bit
 1 = Send Sync Break on next transmission – Start bit, followed by twelve '0' bits, followed by Stop bit; cleared by hardware upon completion
 0 = Sync Break transmission disabled or completed
- bit 10 **UTXEN**: Transmit Enable bit⁽¹⁾
 1 = Transmit enabled, UxTX pin controlled by UARTx
 0 = Transmit disabled, any pending transmission is aborted and buffer is reset. UxTX pin controlled by port
- bit 9 **UTXBF**: Transmit Buffer Full Status bit (read-only)
 1 = Transmit buffer is full
 0 = Transmit buffer is not full, at least one more character can be written
- bit 8 **TRMT**: Transmit Shift Register Empty bit (read-only)
 1 = Transmit Shift Register is empty and transmit buffer is empty (the last transmission has completed)
 0 = Transmit Shift Register is not empty, a transmission is in progress or queued
- bit 7-6 **URXISEL<1:0>**: Receive Interrupt Mode Selection bits
 11 = Interrupt is set on UxRSR transfer making the receive buffer full (i.e., has 4 data characters)
 10 = Interrupt is set on UxRSR transfer making the receive buffer 3/4 full (i.e., has 3 data characters)
 0x = Interrupt is set when any character is received and transferred from the UxRSR to the receive buffer. Receive buffer has one or more characters

Note 1: Refer to **Section 17. "UART"** (DS70232) in the *"dsPIC33F/PIC24H Family Reference Manual"* for information on enabling the UART module for transmit operation.

REGISTER 18-2: UxSTA: UARTx STATUS AND CONTROL REGISTER (CONTINUED)

- bit 5 **ADDEN:** Address Character Detect bit (bit 8 of received data = 1)
1 = Address Detect mode enabled. If 9-bit mode is not selected, this does not take effect
0 = Address Detect mode disabled
- bit 4 **RIDLE:** Receiver Idle bit (read-only)
1 = Receiver is Idle
0 = Receiver is active
- bit 3 **PERR:** Parity Error Status bit (read-only)
1 = Parity error has been detected for the current character (character at the top of the receive FIFO)
0 = Parity error has not been detected
- bit 2 **FERR:** Framing Error Status bit (read-only)
1 = Framing error has been detected for the current character (character at the top of the receive FIFO)
0 = Framing error has not been detected
- bit 1 **OERR:** Receive Buffer Overrun Error Status bit (read/clear only)
1 = Receive buffer has overflowed
0 = Receive buffer has not overflowed. Clearing a previously set OERR bit (1 → 0 transition) resets the receiver buffer and the UxRSR to the empty state
- bit 0 **URXDA:** Receive Buffer Data Available bit (read-only)
1 = Receive buffer has data, at least one more character can be read
0 = Receive buffer is empty

Note 1: Refer to **Section 17. “UART”** (DS70232) in the *“dsPIC33F/PIC24H Family Reference Manual”* for information on enabling the UART module for transmit operation.

19.0 ENHANCED CAN (ECAN™) MODULE

Note 1: This data sheet summarizes the features of the PIC24HJ32GP302/304, PIC24HJ64GPX02/X04 and PIC24HJ128GPX02/X04 families of devices. It is not intended to be a comprehensive reference source. To complement the information in this data sheet, refer to **Section 21. “Enhanced Controller Area Network (ECAN™)”** (DS70185) of the “*dsPIC33F/PIC24H Family Reference Manual*”, which is available from the Microchip web site (www.microchip.com).

2: Some registers and associated bits described in this section may not be available on all devices. Refer to **Section 4.0 “Memory Organization”** in this data sheet for device-specific register and bit information.

19.1 Overview

The Enhanced Controller Area Network (ECAN) module is a serial interface, useful for communicating with other CAN modules or microcontroller devices. This interface/protocol was designed to allow communications within noisy environments. The PIC24HJ32GP302/304, PIC24HJ64GPX02/X04 and PIC24HJ128GPX02/X04 devices contain up to two ECAN modules.

The ECAN module is a communication controller implementing the CAN 2.0 A/B protocol, as defined in the BOSCH CAN specification. The module supports CAN 1.2, CAN 2.0A, CAN 2.0B Passive and CAN 2.0B Active versions of the protocol. The module implementation is a full CAN system. The CAN specification is not covered within this data sheet. The reader can refer to the BOSCH CAN specification for further details.

The module features are as follows:

- Implementation of the CAN protocol, CAN 1.2, CAN 2.0A and CAN 2.0B
- Standard and extended data frames
- Data length of 0-8 bytes
- Programmable bit rate up to 1 Mbit/sec
- Automatic response to remote transmission requests
- Up to eight transmit buffers with application specified prioritization and abort capability (each buffer can contain up to 8 bytes of data)
- Up to 32 receive buffers (each buffer can contain up to 8 bytes of data)
- Up to 16 full (standard/extended identifier) acceptance filters
- Three full acceptance filter masks
- DeviceNet™ addressing support
- Programmable wake-up functionality with integrated low-pass filter
- Programmable Loopback mode supports self-test operation
- Signaling via interrupt capabilities for all CAN receiver and transmitter error states
- Programmable clock source
- Programmable link to input capture module (IC2 for CAN1) for time-stamping and network synchronization
- Low-power Sleep and Idle mode

The CAN bus module consists of a protocol engine and message buffering/control. The CAN protocol engine handles all functions for receiving and transmitting messages on the CAN bus. Messages are transmitted by first loading the appropriate data registers. Status and errors can be checked by reading the appropriate registers. Any message detected on the CAN bus is checked for errors and then matched against filters to see if it should be received and stored in one of the receive registers.

19.2 Frame Types

The ECAN module transmits various types of frames which include data messages, or remote transmission requests initiated by the user, as other frames that are automatically generated for control purposes. The following frame types are supported:

- **Standard Data Frame:**
A standard data frame is generated by a node when the node wishes to transmit data. It includes an 11-bit Standard Identifier (SID), but not an 18-bit Extended Identifier (EID).
- **Extended Data Frame:**
An extended data frame is similar to a standard data frame, but includes an extended identifier as well.
- **Remote Frame:**
It is possible for a destination node to request the data from the source. For this purpose, the destination node sends a remote frame with an identifier that matches the identifier of the required data frame. The appropriate data source node sends a data frame as a response to this remote request.
- **Error Frame:**
An error frame is generated by any node that detects a bus error. An error frame consists of two fields: an error flag field and an error delimiter field.
- **Overload Frame:**
An overload frame can be generated by a node as a result of two conditions. First, the node detects a dominant bit during interframe space which is an illegal condition. Second, due to internal conditions, the node is not yet able to start reception of the next message. A node can generate a maximum of 2 sequential overload frames to delay the start of the next message.
- **Interframe Space:**
Interframe space separates a proceeding frame (of whatever type) from a following data or remote frame.

FIGURE 19-1: ECAN™ MODULE BLOCK DIAGRAM



19.3 Modes of Operation

The ECAN module can operate in one of several operation modes selected by the user. These modes include:

- Initialization mode
- Disable mode
- Normal Operation mode
- Listen Only mode
- Listen All Messages mode
- Loopback mode

Modes are requested by setting the REQOP<2:0> bits (CiCTRL1<10:8>). Entry into a mode is Acknowledged by monitoring the OPMODE<2:0> bits (CiCTRL1<7:5>). The module does not change the mode and the OPMODE bits until a change in mode is acceptable, generally during bus Idle time, which is defined as at least 11 consecutive recessive bits.

19.3.1 INITIALIZATION MODE

In the Initialization mode, the module does not transmit or receive. The error counters are cleared and the interrupt flags remain unchanged. The user application has access to Configuration registers that are access restricted in other modes. The module protects the user from accidentally violating the CAN protocol through programming errors. All registers which control the configuration of the module cannot be modified while the module is on-line. The ECAN module is not allowed to enter the Configuration mode while a transmission is taking place. The Configuration mode serves as a lock to protect the following registers:

- All Module Control registers
- Baud Rate and Interrupt Configuration registers
- Bus Timing registers
- Identifier Acceptance Filter registers
- Identifier Acceptance Mask registers

19.3.2 DISABLE MODE

In Disable mode, the ECAN module does not transmit or receive. The module can set the WAKIF bit due to bus activity, however, any pending interrupts remains and the error counters retains their value.

If the REQOP<2:0> bits (CiCTRL1<10:8>) = 001, the module enters the Module Disable mode. If the module is active, the module waits for 11 recessive bits on the CAN bus, detect that condition as an Idle bus, then accept the module disable command. When the OPMODE<2:0> bits (CiCTRL1<7:5>) = 001, that indicates whether the module successfully went into Module Disable mode. The I/O pins reverts to normal I/O function when the module is in the Module Disable mode.

The module can be programmed to apply a low-pass filter function to the CiRX input line while the module or the CPU is in Sleep mode. The WAKFIL bit (CiCFG2<14>) enables or disables the filter.

Note: Typically, if the ECAN module is allowed to transmit in a particular mode of operation and a transmission is requested immediately after the ECAN module has been placed in that mode of operation, the module waits for 11 consecutive recessive bits on the bus before starting transmission. If the user switches to Disable mode within this 11-bit period, then this transmission is aborted and the corresponding TXABT bit is set and TXREQ bit is cleared.

19.3.3 NORMAL OPERATION MODE

Normal Operation mode is selected when REQOP<2:0> = 000. In this mode, the module is activated and the I/O pins assumes the CAN bus functions. The module transmits and receive CAN bus messages via the CiTX and CiRX pins.

19.3.4 LISTEN ONLY MODE

If the Listen Only mode is activated, the module on the CAN bus is passive. The transmitter buffers revert to the port I/O function. The receive pins remain inputs. For the receiver, no error flags or Acknowledge signals are sent. The error counters are deactivated in this state. The Listen Only mode can be used for detecting the baud rate on the CAN bus. To use this, it is necessary that there are at least two further nodes that communicate with each other.

19.3.5 LISTEN ALL MESSAGES MODE

The module can be set to ignore all errors and receive any message. The Listen All Messages mode is activated by setting REQOP<2:0> = 111. In this mode, the data which is in the message assembly buffer, until the time an error occurred, is copied in the receive buffer and can be read via the CPU interface.

19.3.6 LOOPBACK MODE

If the Loopback mode is activated, the module connects the internal transmit signal to the internal receive signal at the module boundary. The transmit and receive pins revert to their port I/O function.

19.4 ECAN Resources

Many useful resources related to ECAN are provided on the main product page of the Microchip web site for the devices listed in this data sheet. This product page, which can be accessed using this [link](#), contains the latest updates and additional information.

Note: In the event you are not able to access the product page using the link above, enter this URL in your browser:
<http://www.microchip.com/wwwproducts/Devices.aspx?dDocName=en532315>

19.4.1 KEY RESOURCES

- **Section 21. “Enhanced Controller Area Network (ECAN™)” (DS70185)**
- Code Samples
- Application Notes
- Software Libraries
- Webinars
- All related dsPIC33F/PIC24H Family Reference Manuals Sections
- Development Tools

19.5 ECAN Control Registers

REGISTER 19-1: CICTRL1: ECAN™ CONTROL REGISTER 1

U-0	U-0	R/W-0	R/W-0	r-0	R/W-1	R/W-0	R/W-0
—	—	CSIDL	ABAT	—	REQOP<2:0>		
bit 15						bit 8	

R-1	R-0	R-0	U-0	R/W-0	U-0	U-0	R/W-0
OPMODE<2:0>		—	CANCAP	—	—	WIN	
bit 7						bit 0	

Legend:	C = Writable bit, but only '0' can be written to clear the bit	r = Bit is Reserved
R = Readable bit	W = Writable bit	U = Unimplemented bit, read as '0'
-n = Value at POR	'1' = Bit is set	'0' = Bit is cleared
		x = Bit is unknown

- bit 15-14 **Unimplemented:** Read as '0'
- bit 13 **CSIDL:** Stop in Idle Mode bit
 - 1 = Discontinue module operation when device enters Idle mode
 - 0 = Continue module operation in Idle mode
- bit 12 **ABAT:** Abort All Pending Transmissions bit
 - 1 = Signal all transmit buffers to abort transmission
 - 0 = Module will clear this bit when all transmissions are aborted
- bit 11 **Reserved:** Do not use
- bit 10-8 **REQOP<2:0>:** Request Operation Mode bits
 - 000 = Set Normal Operation mode
 - 001 = Set Disable mode
 - 010 = Set Loopback mode
 - 011 = Set Listen Only Mode
 - 100 = Set Configuration mode
 - 101 = Reserved
 - 110 = Reserved
 - 111 = Set Listen All Messages mode
- bit 7-5 **OPMODE<2:0>:** Operation Mode bits
 - 000 = Module is in Normal Operation mode
 - 001 = Module is in Disable mode
 - 010 = Module is in Loopback mode
 - 011 = Module is in Listen Only mode
 - 100 = Module is in Configuration mode
 - 101 = Reserved
 - 110 = Reserved
 - 111 = Module is in Listen All Messages mode
- bit 4 **Unimplemented:** Read as '0'
- bit 3 **CANCAP:** CAN Message Receive Timer Capture Event Enable bit
 - 1 = Enable input capture based on CAN message receive
 - 0 = Disable CAN capture
- bit 2-1 **Unimplemented:** Read as '0'
- bit 0 **WIN:** SFR Map Window Select bit
 - 1 = Use filter window
 - 0 = Use buffer window

REGISTER 19-2: CICTRL2: ECAN™ CONTROL REGISTER 2

U-0	U-0	U-0	U-0	U-0	U-0	U-0	U-0
—	—	—	—	—	—	—	—
bit 15						bit 8	

U-0	U-0	U-0	R-0	R-0	R-0	R-0	R-0
—	—	—	DNCNT<4:0>				
bit 7			bit 0				

Legend:	C = Writeable bit, but only '0' can be written to clear the bit
R = Readable bit	W = Writable bit
-n = Value at POR	'1' = Bit is set
	'0' = Bit is cleared
	x = Bit is unknown

- bit 15-5 **Unimplemented:** Read as '0'
- bit 4-0 **DNCNT<4:0>:** DeviceNet™ Filter Bit Number bits
 - 10010-11111 = Invalid selection
 - 10001 = Compare up to data byte 3, bit 6 with EID<17>
 -
 -
 -
 - 00001 = Compare up to data byte 1, bit 7 with EID<0>
 - 00000 = Do not compare data bytes

REGISTER 19-3: CIVEC: ECAN™ INTERRUPT CODE REGISTER

U-0	U-0	U-0	R-0	R-0	R-0	R-0	R-0	
—	—	—	FILHIT<4:0>					
bit 15								bit 8

U-0	R-1	R-0	R-0	R-0	R-0	R-0	R-0
—	ICODE<6:0>						
bit 7							bit 0

Legend:	C = Writeable bit, but only '0' can be written to clear the bit		
R = Readable bit	W = Writable bit	U = Unimplemented bit, read as '0'	
-n = Value at POR	'1' = Bit is set	'0' = Bit is cleared	x = Bit is unknown

- bit 15-13 **Unimplemented:** Read as '0'
- bit 12-8 **FILHIT<4:0>:** Filter Hit Number bits
 - 10000-11111 = Reserved
 - 01111 = Filter 15
 -
 -
 -
 - 00001 = Filter 1
 - 00000 = Filter 0
- bit 7 **Unimplemented:** Read as '0'
- bit 6-0 **ICODE<6:0>:** Interrupt Flag Code bits
 - 1000101-1111111 = Reserved
 - 1000100 = FIFO almost full interrupt
 - 1000011 = Receiver overflow interrupt
 - 1000010 = Wake-up interrupt
 - 1000001 = Error interrupt
 - 1000000 = No interrupt
 -
 -
 -
 - 0010000-0111111 = Reserved
 - 0001111 = RB15 buffer Interrupt
 -
 -
 -
 - 0001001 = RB9 buffer interrupt
 - 0001000 = RB8 buffer interrupt
 - 0000111 = TRB7 buffer interrupt
 - 0000110 = TRB6 buffer interrupt
 - 0000101 = TRB5 buffer interrupt
 - 0000100 = TRB4 buffer interrupt
 - 0000011 = TRB3 buffer interrupt
 - 0000010 = TRB2 buffer interrupt
 - 0000001 = TRB1 buffer interrupt
 - 0000000 = TRB0 Buffer interrupt

REGISTER 19-4: CIFCTRL: ECAN™ FIFO CONTROL REGISTER

R/W-0	R/W-0	R/W-0	U-0	U-0	U-0	U-0	U-0	
DMABS<2:0>			—	—	—	—	—	
bit 15								bit 8

U-0	U-0	U-0	R/W-0	R/W-0	R/W-0	R/W-0	R/W-0	
—	—	—	FSA<4:0>					
bit 7								bit 0

Legend:	C = Writeable bit, but only '0' can be written to clear the bit		
R = Readable bit	W = Writable bit	U = Unimplemented bit, read as '0'	
-n = Value at POR	'1' = Bit is set	'0' = Bit is cleared	x = Bit is unknown

bit 15-13 **DMABS<2:0>**: DMA Buffer Size bits

- 111 = Reserved
- 110 = 32 buffers in DMA RAM
- 101 = 24 buffers in DMA RAM
- 100 = 16 buffers in DMA RAM
- 011 = 12 buffers in DMA RAM
- 010 = 8 buffers in DMA RAM
- 001 = 6 buffers in DMA RAM
- 000 = 4 buffers in DMA RAM

bit 12-5 **Unimplemented**: Read as '0'

bit 4-0 **FSA<4:0>**: FIFO Area Starts with Buffer bits

- 11111 = Read buffer RB31
- 11110 = Read buffer RB30
-
-
-
- 00001 = TX/RX buffer TRB1
- 00000 = TX/RX buffer TRB0

PIC24HJ32GP302/304, PIC24HJ64GPX02/X04 AND PIC24HJ128GPX02/X04

REGISTER 19-5: CiFIFO: ECAN™ FIFO STATUS REGISTER

U-0	U-0	R-0	R-0	R-0	R-0	R-0	R-0	
—	—	FBP<5:0>						
bit 15						bit 8		

U-0	U-0	R-0	R-0	R-0	R-0	R-0	R-0	
—	—	FNRB<5:0>						
bit 7						bit 0		

Legend:	C = Writable bit, but only '0' can be written to clear the bit
R = Readable bit	W = Writable bit U = Unimplemented bit, read as '0'
-n = Value at POR	'1' = Bit is set '0' = Bit is cleared x = Bit is unknown

bit 15-14 **Unimplemented:** Read as '0'

bit 13-8 **FBP<5:0>:** FIFO Buffer Pointer bits

011111 = RB31 buffer

011110 = RB30 buffer

•

•

•

000001 = TRB1 buffer

000000 = TRB0 buffer

bit 7-6 **Unimplemented:** Read as '0'

bit 5-0 **FNRB<5:0>:** FIFO Next Read Buffer Pointer bits

011111 = RB31 buffer

011110 = RB30 buffer

•

•

•

000001 = TRB1 buffer

000000 = TRB0 buffer

REGISTER 19-6: CiINTF: ECAN™ INTERRUPT FLAG REGISTER

U-0	U-0	R-0	R-0	R-0	R-0	R-0	R-0
—	—	TXBO	TXBP	RXBP	TXWAR	RXWAR	EWARN
bit 15							bit 8

R/C-0	R/C-0	R/C-0	U-0	R/C-0	R/C-0	R/C-0	R/C-0
IVRIF	WAKIF	ERRIF	—	FIFOIF	RBOVIF	RBIF	TBIF
bit 7							bit 0

Legend:	C = Writeable bit, but only '0' can be written to clear the bit
R = Readable bit	W = Writable bit U = Unimplemented bit, read as '0'
-n = Value at POR	'1' = Bit is set '0' = Bit is cleared x = Bit is unknown

- bit 15-14 **Unimplemented:** Read as '0'
- bit 13 **TXBO:** Transmitter in Error State Bus Off bit
 1 = Transmitter is in Bus Off state
 0 = Transmitter is not in Bus Off state
- bit 12 **TXBP:** Transmitter in Error State Bus Passive bit
 1 = Transmitter is in Bus Passive state
 0 = Transmitter is not in Bus Passive state
- bit 11 **RXBP:** Receiver in Error State Bus Passive bit
 1 = Receiver is in Bus Passive state
 0 = Receiver is not in Bus Passive state
- bit 10 **TXWAR:** Transmitter in Error State Warning bit
 1 = Transmitter is in Error Warning state
 0 = Transmitter is not in Error Warning state
- bit 9 **RXWAR:** Receiver in Error State Warning bit
 1 = Receiver is in Error Warning state
 0 = Receiver is not in Error Warning state
- bit 8 **EWARN:** Transmitter or Receiver in Error State Warning bit
 1 = Transmitter or Receiver is in Error State Warning state
 0 = Transmitter or Receiver is not in Error State Warning state
- bit 7 **IVRIF:** Invalid Message Received Interrupt Flag bit
 1 = Interrupt Request has occurred
 0 = Interrupt Request has not occurred
- bit 6 **WAKIF:** Bus Wake-up Activity Interrupt Flag bit
 1 = Interrupt Request has occurred
 0 = Interrupt Request has not occurred
- bit 5 **ERRIF:** Error Interrupt Flag bit (multiple sources in CiINTF<13:8> register)
 1 = Interrupt Request has occurred
 0 = Interrupt Request has not occurred
- bit 4 **Unimplemented:** Read as '0'
- bit 3 **FIFOIF:** FIFO Almost Full Interrupt Flag bit
 1 = Interrupt Request has occurred
 0 = Interrupt Request has not occurred
- bit 2 **RBOVIF:** RX Buffer Overflow Interrupt Flag bit
 1 = Interrupt Request has occurred
 0 = Interrupt Request has not occurred
- bit 1 **RBIF:** RX Buffer Interrupt Flag bit
 1 = Interrupt Request has occurred
 0 = Interrupt Request has not occurred
- bit 0 **TBIF:** TX Buffer Interrupt Flag bit
 1 = Interrupt Request has occurred
 0 = Interrupt Request has not occurred

PIC24HJ32GP302/304, PIC24HJ64GPX02/X04 AND PIC24HJ128GPX02/X04

REGISTER 19-7: CIINTE: ECAN™ INTERRUPT ENABLE REGISTER

U-0	U-0	U-0	U-0	U-0	U-0	U-0	U-0
—	—	—	—	—	—	—	—
bit 15							bit 8

R/W-0	R/W-0	R/W-0	U-0	R/W-0	R/W-0	R/W-0	R/W-0
IVRIE	WAKIE	ERRIE	—	FIFOIE	RBOVIE	RBIE	TBIE
bit 7							bit 0

Legend:	C = Writeable bit, but only '0' can be written to clear the bit
R = Readable bit	W = Writable bit U = Unimplemented bit, read as '0'
-n = Value at POR	'1' = Bit is set '0' = Bit is cleared x = Bit is unknown

- bit 15-8 **Unimplemented:** Read as '0'
- bit 7 **IVRIE:** Invalid Message Received Interrupt Enable bit
1 = Interrupt Request Enabled
0 = Interrupt Request not enabled
- bit 6 **WAKIE:** Bus Wake-up Activity Interrupt Flag bit
1 = Interrupt Request Enabled
0 = Interrupt Request not enabled
- bit 5 **ERRIE:** Error Interrupt Enable bit
1 = Interrupt Request Enabled
0 = Interrupt Request not enabled
- bit 4 **Unimplemented:** Read as '0'
- bit 3 **FIFOIE:** FIFO Almost Full Interrupt Enable bit
1 = Interrupt Request Enabled
0 = Interrupt Request not enabled
- bit 2 **RBOVIE:** RX Buffer Overflow Interrupt Enable bit
1 = Interrupt Request Enabled
0 = Interrupt Request not enabled
- bit 1 **RBIE:** RX Buffer Interrupt Enable bit
1 = Interrupt Request Enabled
0 = Interrupt Request not enabled
- bit 0 **TBIE:** TX Buffer Interrupt Enable bit
1 = Interrupt Request Enabled
0 = Interrupt Request not enabled

REGISTER 19-8: CIEC: ECAN™ TRANSMIT/RECEIVE ERROR COUNT REGISTER

R-0	R-0	R-0	R-0	R-0	R-0	R-0	R-0
TERRCNT<7:0>							
bit 15							bit 8

R-0	R-0	R-0	R-0	R-0	R-0	R-0	R-0
RERRCNT<7:0>							
bit 7							bit 0

Legend:	C = Writeable bit, but only '0' can be written to clear the bit
R = Readable bit	W = Writable bit U = Unimplemented bit, read as '0'
-n = Value at POR	'1' = Bit is set '0' = Bit is cleared x = Bit is unknown

bit 15-8 **TERRCNT<7:0>**: Transmit Error Count bits
bit 7-0 **RERRCNT<7:0>**: Receive Error Count bits

REGISTER 19-9: CIECFG1: ECAN™ BAUD RATE CONFIGURATION REGISTER 1

U-0	U-0	U-0	U-0	U-0	U-0	U-0	U-0
—	—	—	—	—	—	—	—
bit 15							bit 8

R/W-0	R/W-0	R/W-0	R/W-0	R/W-0	R/W-0	R/W-0	R/W-0
SJW<1:0>		BRP<5:0>					
bit 7							bit 0

Legend:	W = Writable bit	U = Unimplemented bit, read as '0'
R = Readable bit	'1' = Bit is set	'0' = Bit is cleared
-n = Value at POR		x = Bit is unknown

bit 15-8 **Unimplemented:** Read as '0'
bit 7-6 **SJW<1:0>**: Synchronization Jump Width bits
 11 = Length is 4 x T_Q
 10 = Length is 3 x T_Q
 01 = Length is 2 x T_Q
 00 = Length is 1 x T_Q
bit 5-0 **BRP<5:0>**: Baud Rate Prescaler bits
 11 1111 = T_Q = 2 x 64 x 1/FCAN
 •
 •
 •
 00 0010 = T_Q = 2 x 3 x 1/FCAN
 00 0001 = T_Q = 2 x 2 x 1/FCAN
 00 0000 = T_Q = 2 x 1 x 1/FCAN

REGISTER 19-10: C1CFG2: ECAN™ BAUD RATE CONFIGURATION REGISTER 2

U-0	R/W-x	U-0	U-0	U-0	R/W-x	R/W-x	R/W-x
—	WAKFIL	—	—	—	SEG2PH<2:0>		
bit 15							bit 8

R/W-x	R/W-x	R/W-x	R/W-x	R/W-x	R/W-x	R/W-x	R/W-x
SEG2PHTS	SAM	SEG1PH<2:0>			PRSEG<2:0>		
bit 7							bit 0

Legend:

R = Readable bit	W = Writable bit	U = Unimplemented bit, read as '0'
-n = Value at POR	'1' = Bit is set	'0' = Bit is cleared
		x = Bit is unknown

- bit 15 **Unimplemented:** Read as '0'
- bit 14 **WAKFIL:** Select CAN bus Line Filter for Wake-up bit
 - 1 = Use CAN bus line filter for wake-up
 - 0 = CAN bus line filter is not used for wake-up
- bit 13-11 **Unimplemented:** Read as '0'
- bit 10-8 **SEG2PH<2:0>:** Phase Segment 2 bits
 - 111 = Length is 8 x T_Q
 -
 -
 -
 - 000 = Length is 1 x T_Q
- bit 7 **SEG2PHTS:** Phase Segment 2 Time Select bit
 - 1 = Freely programmable
 - 0 = Maximum of SEG1PH bits or Information Processing Time (IPT), whichever is greater
- bit 6 **SAM:** Sample of the CAN bus Line bit
 - 1 = Bus line is sampled three times at the sample point
 - 0 = Bus line is sampled once at the sample point
- bit 5-3 **SEG1PH<2:0>:** Phase Segment 1 bits
 - 111 = Length is 8 x T_Q
 -
 -
 -
 - 000 = Length is 1 x T_Q
- bit 2-0 **PRSEG<2:0>:** Propagation Time Segment bits
 - 111 = Length is 8 x T_Q
 -
 -
 -
 - 000 = Length is 1 x T_Q

REGISTER 19-11: CIFEN1: ECAN™ ACCEPTANCE FILTER ENABLE REGISTER

R/W-1	R/W-1	R/W-1	R/W-1	R/W-1	R/W-1	R/W-1	R/W-1
FLTEN15	FLTEN14	FLTEN13	FLTEN12	FLTEN11	FLTEN10	FLTEN9	FLTEN8
bit 15							bit 8

R/W-1	R/W-1	R/W-1	R/W-1	R/W-1	R/W-1	R/W-1	R/W-1
FLTEN7	FLTEN6	FLTEN5	FLTEN4	FLTEN3	FLTEN2	FLTEN1	FLTEN0
bit 7							bit 0

Legend:	C = Writeable bit, but only '0' can be written to clear the bit
R = Readable bit	W = Writable bit U = Unimplemented bit, read as '0'
-n = Value at POR	'1' = Bit is set '0' = Bit is cleared x = Bit is unknown

bit 15-0 **FLTENn:** Enable Filter n to Accept Messages bits
 1 = Enable Filter n
 0 = Disable Filter n

REGISTER 19-12: CIBUFPNT1: ECAN™ FILTER 0-3 BUFFER POINTER REGISTER

R/W-0	R/W-0	R/W-0	R/W-0	R/W-0	R/W-0	R/W-0	R/W-0
F3BP<3:0>				F2BP<3:0>			
bit 15							bit 8

R/W-0	R/W-0	R/W-0	R/W-0	R/W-0	R/W-0	R/W-0	R/W-0
F1BP<3:0>				F0BP<3:0>			
bit 7							bit 0

Legend:	C = Writeable bit, but only '0' can be written to clear the bit
R = Readable bit	W = Writable bit U = Unimplemented bit, read as '0'
-n = Value at POR	'1' = Bit is set '0' = Bit is cleared x = Bit is unknown

bit 15-12 **F3BP<3:0>:** RX Buffer mask for Filter 3
 1111 = Filter hits received in RX FIFO buffer
 1110 = Filter hits received in RX Buffer 14
 •
 •
 •
 0001 = Filter hits received in RX Buffer 1
 0000 = Filter hits received in RX Buffer 0

bit 11-8 **F2BP<3:0>:** RX Buffer mask for Filter 2 (same values as bit 15-12)
 bit 7-4 **F1BP<3:0>:** RX Buffer mask for Filter 1 (same values as bit 15-12)
 bit 3-0 **F0BP<3:0>:** RX Buffer mask for Filter 0 (same values as bit 15-12)

PIC24HJ32GP302/304, PIC24HJ64GPX02/X04 AND PIC24HJ128GPX02/X04

REGISTER 19-13: CiBUPNT2: ECAN™ FILTER 4-7 BUFFER POINTER REGISTER

R/W-0	R/W-0	R/W-0	R/W-0	R/W-0	R/W-0	R/W-0	R/W-0
F7BP<3:0>				F6BP<3:0>			
bit 15				bit 8			

R/W-0	R/W-0	R/W-0	R/W-0	R/W-0	R/W-0	R/W-0	R/W-0
F5BP<3:0>				F4BP<3:0>			
bit 7				bit 0			

Legend:	C = Writeable bit, but only '0' can be written to clear the bit		
R = Readable bit	W = Writable bit	U = Unimplemented bit, read as '0'	
-n = Value at POR	'1' = Bit is set	'0' = Bit is cleared	x = Bit is unknown

bit 15-12 **F7BP<3:0>**: RX Buffer mask for Filter 7
 1111 = Filter hits received in RX FIFO buffer
 1110 = Filter hits received in RX Buffer 14
 •
 •
 •
 0001 = Filter hits received in RX Buffer 1
 0000 = Filter hits received in RX Buffer 0

bit 11-8 **F6BP<3:0>**: RX Buffer mask for Filter 6 (same values as bit 15-12)

bit 7-4 **F5BP<3:0>**: RX Buffer mask for Filter 5 (same values as bit 15-12)

bit 3-0 **F4BP<3:0>**: RX Buffer mask for Filter 4 (same values as bit 15-12)

REGISTER 19-14: CiBUPNT3: ECAN™ FILTER 8-11 BUFFER POINTER REGISTER

R/W-0	R/W-0	R/W-0	R/W-0	R/W-0	R/W-0	R/W-0	R/W-0
F11BP<3:0>				F10BP<3:0>			
bit 15				bit 8			

R/W-0	R/W-0	R/W-0	R/W-0	R/W-0	R/W-0	R/W-0	R/W-0
F9BP<3:0>				F8BP<3:0>			
bit 7				bit 0			

Legend:	C = Writeable bit, but only '0' can be written to clear the bit		
R = Readable bit	W = Writable bit	U = Unimplemented bit, read as '0'	
-n = Value at POR	'1' = Bit is set	'0' = Bit is cleared	x = Bit is unknown

bit 15-12 **F11BP<3:0>**: RX Buffer mask for Filter 11
 1111 = Filter hits received in RX FIFO buffer
 1110 = Filter hits received in RX Buffer 14
 •
 •
 •
 0001 = Filter hits received in RX Buffer 1
 0000 = Filter hits received in RX Buffer 0

bit 11-8 **F10BP<3:0>**: RX Buffer mask for Filter 10 (same values as bit 15-12)

bit 7-4 **F9BP<3:0>**: RX Buffer mask for Filter 9 (same values as bit 15-12)

bit 3-0 **F8BP<3:0>**: RX Buffer mask for Filter 8 (same values as bit 15-12)

REGISTER 19-15: CiBUFNT4: ECAN™ FILTER 12-15 BUFFER POINTER REGISTER

R/W-0	R/W-0	R/W-0	R/W-0	R/W-0	R/W-0	R/W-0	R/W-0
F15BP<3:0>				F14BP<3:0>			
bit 15				bit 8			

R/W-0	R/W-0	R/W-0	R/W-0	R/W-0	R/W-0	R/W-0	R/W-0
F13BP<3:0>				F12BP<3:0>			
bit 7				bit 0			

Legend:	C = Writeable bit, but only '0' can be written to clear the bit
R = Readable bit	W = Writable bit U = Unimplemented bit, read as '0'
-n = Value at POR	'1' = Bit is set '0' = Bit is cleared x = Bit is unknown

- bit 15-12 **F15BP<3:0>**: RX Buffer mask for Filter 15
 - 1111 = Filter hits received in RX FIFO buffer
 - 1110 = Filter hits received in RX Buffer 14
 -
 -
 -
 - 0001 = Filter hits received in RX Buffer 1
 - 0000 = Filter hits received in RX Buffer 0
- bit 11-8 **F14BP<3:0>**: RX Buffer mask for Filter 14 (same values as bit 15-12)
- bit 7-4 **F13BP<3:0>**: RX Buffer mask for Filter 13 (same values as bit 15-12)
- bit 3-0 **F12BP<3:0>**: RX Buffer mask for Filter 12 (same values as bit 15-12)

PIC24HJ32GP302/304, PIC24HJ64GPX02/X04 AND PIC24HJ128GPX02/X04

REGISTER 19-16: C_iRXF_nSID: ECAN™ ACCEPTANCE FILTER STANDARD IDENTIFIER REGISTER n (n = 0-15)

R/W-x	R/W-x	R/W-x	R/W-x	R/W-x	R/W-x	R/W-x	R/W-x
SID10	SID9	SID8	SID7	SID6	SID5	SID4	SID3
bit 15							bit 8

R/W-x	R/W-x	R/W-x	U-0	R/W-x	U-0	R/W-x	R/W-x
SID2	SID1	SID0	—	EXIDE	—	EID17	EID16
bit 7							bit 0

Legend:	C = Writeable bit, but only '0' can be written to clear the bit
R = Readable bit	W = Writable bit U = Unimplemented bit, read as '0'
-n = Value at POR	'1' = Bit is set '0' = Bit is cleared x = Bit is unknown

- bit 15-5 **SID<10:0>**: Standard Identifier bits
 - 1 = Message address bit SID_x must be '1' to match filter
 - 0 = Message address bit SID_x must be '0' to match filter
- bit 4 **Unimplemented**: Read as '0'
- bit 3 **EXIDE**: Extended Identifier Enable bit
 - If MIDE = 1, then:
 - 1 = Match only messages with extended identifier addresses
 - 0 = Match only messages with standard identifier addresses
 - If MIDE = 0, then:
 - Ignore the EXIDE bit.
- bit 2 **Unimplemented**: Read as '0'
- bit 1-0 **EID<17:16>**: Extended Identifier bits
 - 1 = Message address bit EID_x must be '1' to match filter
 - 0 = Message address bit EID_x must be '0' to match filter

**REGISTER 19-17: C_{IRXF_n}EID: ECAN™ ACCEPTANCE FILTER EXTENDED IDENTIFIER REGISTER
n (n = 0-15)**

R/W-x	R/W-x	R/W-x	R/W-x	R/W-x	R/W-x	R/W-x	R/W-x
EID15	EID14	EID13	EID12	EID11	EID10	EID9	EID8
bit 15							bit 8

R/W-x	R/W-x	R/W-x	R/W-x	R/W-x	R/W-x	R/W-x	R/W-x
EID7	EID6	EID5	EID4	EID3	EID2	EID1	EID0
bit 7							bit 0

Legend:	C = Writeable bit, but only '0' can be written to clear the bit
R = Readable bit	W = Writable bit U = Unimplemented bit, read as '0'
-n = Value at POR	'1' = Bit is set '0' = Bit is cleared x = Bit is unknown

bit 15-0 **EID<15:0>**: Extended Identifier bits
 1 = Message address bit EID_x must be '1' to match filter
 0 = Message address bit EID_x must be '0' to match filter

REGISTER 19-18: C_iFMSKSEL1: ECAN™ FILTER 7-0 MASK SELECTION REGISTER

R/W-0	R/W-0	R/W-0	R/W-0	R/W-0	R/W-0	R/W-0	R/W-0
F7MSK<1:0>		F6MSK<1:0>		F5MSK<1:0>		F4MSK<1:0>	
bit 15							bit 8

R/W-0	R/W-0	R/W-0	R/W-0	R/W-0	R/W-0	R/W-0	R/W-0
F3MSK<1:0>		F2MSK<1:0>		F1MSK<1:0>		F0MSK<1:0>	
bit 7							bit 0

Legend:	C = Writeable bit, but only '0' can be written to clear the bit
R = Readable bit	W = Writable bit U = Unimplemented bit, read as '0'
-n = Value at POR	'1' = Bit is set '0' = Bit is cleared x = Bit is unknown

bit 15-14 **F7MSK<1:0>**: Mask Source for Filter 7 bit
 11 = No mask
 10 = Acceptance Mask 2 registers contain mask
 01 = Acceptance Mask 1 registers contain mask
 00 = Acceptance Mask 0 registers contain mask

bit 13-12 **F6MSK<1:0>**: Mask Source for Filter 6 bit (same values as bit 15-14)

bit 11-10 **F5MSK<1:0>**: Mask Source for Filter 5 bit (same values as bit 15-14)

bit 9-8 **F4MSK<1:0>**: Mask Source for Filter 4 bit (same values as bit 15-14)

bit 7-6 **F3MSK<1:0>**: Mask Source for Filter 3 bit (same values as bit 15-14)

bit 5-4 **F2MSK<1:0>**: Mask Source for Filter 2 bit (same values as bit 15-14)

bit 3-2 **F1MSK<1:0>**: Mask Source for Filter 1 bit (same values as bit 15-14)

bit 1-0 **F0MSK<1:0>**: Mask Source for Filter 0 bit (same values as bit 15-14)

PIC24HJ32GP302/304, PIC24HJ64GPX02/X04 AND PIC24HJ128GPX02/X04

REGISTER 19-19: C1FMSKSEL2: ECAN™ FILTER 15-8 MASK SELECTION REGISTER

R/W-0	R/W-0	R/W-0	R/W-0	R/W-0	R/W-0	R/W-0	R/W-0
F15MSK<1:0>		F14MSK<1:0>		F13MSK<1:0>		F12MSK<1:0>	
bit 15							bit 8

R/W-0	R/W-0	R/W-0	R/W-0	R/W-0	R/W-0	R/W-0	R/W-0
F11MSK<1:0>		F10MSK<1:0>		F9MSK<1:0>		F8MSK<1:0>	
bit 7							bit 0

Legend:	C = Writeable bit, but only '0' can be written to clear the bit
R = Readable bit	W = Writable bit U = Unimplemented bit, read as '0'
-n = Value at POR	'1' = Bit is set '0' = Bit is cleared x = Bit is unknown

- bit 15-14 **F15MSK<1:0>**: Mask Source for Filter 15 bit
 11 = No mask
 10 = Acceptance Mask 2 registers contain mask
 01 = Acceptance Mask 1 registers contain mask
 00 = Acceptance Mask 0 registers contain mask
- bit 13-12 **F14MSK<1:0>**: Mask Source for Filter 14 bit (same values as bit 15-14)
- bit 11-10 **F13MSK<1:0>**: Mask Source for Filter 13 bit (same values as bit 15-14)
- bit 9-8 **F12MSK<1:0>**: Mask Source for Filter 12 bit (same values as bit 15-14)
- bit 7-6 **F11MSK<1:0>**: Mask Source for Filter 11 bit (same values as bit 15-14)
- bit 5-4 **F10MSK<1:0>**: Mask Source for Filter 10 bit (same values as bit 15-14)
- bit 3-2 **F9MSK<1:0>**: Mask Source for Filter 9 bit (same values as bit 15-14)
- bit 1-0 **F8MSK<1:0>**: Mask Source for Filter 8 bit (same values as bit 15-14)

**REGISTER 19-20: C_{IRXMn}SID: ECAN™ ACCEPTANCE FILTER MASK STANDARD IDENTIFIER
REGISTER n (n = 0-2)**

R/W-x	R/W-x	R/W-x	R/W-x	R/W-x	R/W-x	R/W-x	R/W-x
SID10	SID9	SID8	SID7	SID6	SID5	SID4	SID3
bit 15							bit 8

R/W-x	R/W-x	R/W-x	U-0	R/W-x	U-0	R/W-x	R/W-x
SID2	SID1	SID0	—	MIDE	—	EID17	EID16
bit 7							bit 0

Legend:	C = Writeable bit, but only '0' can be written to clear the bit
R = Readable bit	W = Writable bit
-n = Value at POR	'1' = Bit is set
	U = Unimplemented bit, read as '0'
	'0' = Bit is cleared
	x = Bit is unknown

- bit 15-5 **SID<10:0>**: Standard Identifier bits
 - 1 = Include bit SID_x in filter comparison
 - 0 = Bit SID_x is don't care in filter comparison
- bit 4 **Unimplemented**: Read as '0'
- bit 3 **MIDE**: Identifier Receive Mode bit
 - 1 = Match only message types (standard or extended address) that correspond to EXIDE bit in filter
 - 0 = Match either standard or extended address message if filters match
(i.e., if (Filter SID) = (Message SID) or if (Filter SID/EID) = (Message SID/EID))
- bit 2 **Unimplemented**: Read as '0'
- bit 1-0 **EID<17:16>**: Extended Identifier bits
 - 1 = Include bit EID_x in filter comparison
 - 0 = Bit EID_x is don't care in filter comparison

**REGISTER 19-21: C_{IRXMn}EID: ECAN™ ACCEPTANCE FILTER MASK EXTENDED IDENTIFIER
REGISTER n (n = 0-2)**

R/W-x	R/W-x	R/W-x	R/W-x	R/W-x	R/W-x	R/W-x	R/W-x
EID15	EID14	EID13	EID12	EID11	EID10	EID9	EID8
bit 15							bit 8

R/W-x	R/W-x	R/W-x	R/W-x	R/W-x	R/W-x	R/W-x	R/W-x
EID7	EID6	EID5	EID4	EID3	EID2	EID1	EID0
bit 7							bit 0

Legend:	C = Writeable bit, but only '0' can be written to clear the bit
R = Readable bit	W = Writable bit
-n = Value at POR	'1' = Bit is set
	U = Unimplemented bit, read as '0'
	'0' = Bit is cleared
	x = Bit is unknown

- bit 15-0 **EID<15:0>**: Extended Identifier bits
 - 1 = Include bit EID_x in filter comparison
 - 0 = Bit EID_x is don't care in filter comparison

PIC24HJ32GP302/304, PIC24HJ64GPX02/X04 AND PIC24HJ128GPX02/X04

REGISTER 19-22: CIRXFUL1: ECAN™ RECEIVE BUFFER FULL REGISTER 1

R/C-0	R/C-0	R/C-0	R/C-0	R/C-0	R/C-0	R/C-0	R/C-0
RXFUL15	RXFUL14	RXFUL13	RXFUL12	RXFUL11	RXFUL10	RXFUL9	RXFUL8
bit 15							bit 8

R/C-0	R/C-0	R/C-0	R/C-0	R/C-0	R/C-0	R/C-0	R/C-0
RXFUL7	RXFUL6	RXFUL5	RXFUL4	RXFUL3	RXFUL2	RXFUL1	RXFUL0
bit 7							bit 0

Legend:	C = Writeable bit, but only '0' can be written to clear the bit
R = Readable bit	W = Writable bit U = Unimplemented bit, read as '0'
-n = Value at POR	'1' = Bit is set '0' = Bit is cleared x = Bit is unknown

bit 15-0 **RXFUL<15:0>**: Receive Buffer n Full bits
 1 = Buffer is full (set by module)
 0 = Buffer is empty

REGISTER 19-23: CIRXFUL2: ECAN™ RECEIVE BUFFER FULL REGISTER 2

R/C-0	R/C-0	R/C-0	R/C-0	R/C-0	R/C-0	R/C-0	R/C-0
RXFUL31	RXFUL30	RXFUL29	RXFUL28	RXFUL27	RXFUL26	RXFUL25	RXFUL24
bit 15							bit 8

R/C-0	R/C-0	R/C-0	R/C-0	R/C-0	R/C-0	R/C-0	R/C-0
RXFUL23	RXFUL22	RXFUL21	RXFUL20	RXFUL19	RXFUL18	RXFUL17	RXFUL16
bit 7							bit 0

Legend:	C = Writeable bit, but only '0' can be written to clear the bit
R = Readable bit	W = Writable bit U = Unimplemented bit, read as '0'
-n = Value at POR	'1' = Bit is set '0' = Bit is cleared x = Bit is unknown

bit 15-0 **RXFUL<31:16>**: Receive Buffer n Full bits
 1 = Buffer is full (set by module)
 0 = Buffer is empty

REGISTER 19-24: CIRXOVF1: ECAN™ RECEIVE BUFFER OVERFLOW REGISTER 1

R/C-0	R/C-0	R/C-0	R/C-0	R/C-0	R/C-0	R/C-0	R/C-0
RXOVF15	RXOVF14	RXOVF13	RXOVF12	RXOVF11	RXOVF10	RXOVF9	RXOVF8
bit 15							bit 8

R/C-0	R/C-0	R/C-0	R/C-0	R/C-0	R/C-0	R/C-0	R/C-0
RXOVF7	RXOVF6	RXOVF5	RXOVF4	RXOVF3	RXOVF2	RXOVF1	RXOVF0
bit 7							bit 0

Legend:	C = Writeable bit, but only '0' can be written to clear the bit
R = Readable bit	W = Writable bit U = Unimplemented bit, read as '0'
-n = Value at POR	'1' = Bit is set '0' = Bit is cleared x = Bit is unknown

bit 15-0 **RXOVF<15:0>**: Receive Buffer n Overflow bits
 1 = Module attempted to write to a full buffer (set by module)
 0 = No overflow condition

REGISTER 19-25: CIRXOVF2: ECAN™ RECEIVE BUFFER OVERFLOW REGISTER 2

R/C-0	R/C-0	R/C-0	R/C-0	R/C-0	R/C-0	R/C-0	R/C-0
RXOVF31	RXOVF30	RXOVF29	RXOVF28	RXOVF27	RXOVF26	RXOVF25	RXOVF24
bit 15							bit 8

R/C-0	R/C-0	R/C-0	R/C-0	R/C-0	R/C-0	R/C-0	R/C-0
RXOVF23	RXOVF22	RXOVF21	RXOVF20	RXOVF19	RXOVF18	RXOVF17	RXOVF16
bit 7							bit 0

Legend:	C = Writeable bit, but only '0' can be written to clear the bit
R = Readable bit	W = Writable bit U = Unimplemented bit, read as '0'
-n = Value at POR	'1' = Bit is set '0' = Bit is cleared x = Bit is unknown

bit 15-0 **RXOVF<31:16>**: Receive Buffer n Overflow bits
 1 = Module attempted to write to a full buffer (set by module)
 0 = No overflow condition

PIC24HJ32GP302/304, PIC24HJ64GPX02/X04 AND PIC24HJ128GPX02/X04

REGISTER 19-26: CiTRmnCON: ECAN™ TX/RX BUFFER m CONTROL REGISTER (m = 0,2,4,6; n = 1,3,5,7)

R/W-0	R-0	R-0	R-0	R/W-0	R/W-0	R/W-0	R/W-0
TXENn	TXABTn	TXLARBn	TXERRn	TXREQn	RTRENn	TXnPRI<1:0>	
bit 15						bit 8	

R/W-0	R-0	R-0	R-0	R/W-0	R/W-0	R/W-0	R/W-0
TXENm	TXABTm ⁽¹⁾	TXLARBm ⁽¹⁾	TXERRm ⁽¹⁾	TXREQm	RTRENm	TXmPRI<1:0>	
bit 7						bit 0	

Legend:	C = Writeable bit, but only '0' can be written to clear the bit
R = Readable bit	W = Writable bit U = Unimplemented bit, read as '0'
-n = Value at POR	'1' = Bit is set '0' = Bit is cleared x = Bit is unknown

- bit 15-8 See Definition for Bits 7-0, Controls Buffer n
- bit 7 **TXENm:** TX/RX Buffer Selection bit
 1 = Buffer TRBn is a transmit buffer
 0 = Buffer TRBn is a receive buffer
- bit 6 **TXABTm:** Message Aborted bit⁽¹⁾
 1 = Message was aborted
 0 = Message completed transmission successfully
- bit 5 **TXLARBm:** Message Lost Arbitration bit⁽¹⁾
 1 = Message lost arbitration while being sent
 0 = Message did not lose arbitration while being sent
- bit 4 **TXERRm:** Error Detected During Transmission bit⁽¹⁾
 1 = A bus error occurred while the message was being sent
 0 = A bus error did not occur while the message was being sent
- bit 3 **TXREQm:** Message Send Request bit
 1 = Requests that a message be sent. The bit automatically clears when the message is successfully sent
 0 = Clearing the bit to '0' while set requests a message abort
- bit 2 **RTRENm:** Auto-Remote Transmit Enable bit
 1 = When a remote transmit is received, TXREQ will be set
 0 = When a remote transmit is received, TXREQ will be unaffected
- bit 1-0 **TXmPRI<1:0>:** Message Transmission Priority bits
 11 = Highest message priority
 10 = High intermediate message priority
 01 = Low intermediate message priority
 00 = Lowest message priority

Note 1: This bit is cleared when the TXREQ bit is set.

Note: The buffers, SID, EID, DLC, Data Field and Receive Status registers are located in DMA RAM.

19.6 ECAN Message Buffers

ECAN Message Buffers are part of DMA RAM Memory. They are not ECAN special function registers. The user application must directly write into the DMA RAM area that is configured for ECAN Message Buffers. The location and size of the buffer area is defined by the user application.

BUFFER 19-1: ECAN™ MESSAGE BUFFER WORD 0

U-0	U-0	U-0	R/W-x	R/W-x	R/W-x	R/W-x	R/W-x
—	—	—	SID10	SID9	SID8	SID7	SID6
bit 15							bit 8

R/W-x	R/W-x	R/W-x	R/W-x	R/W-x	R/W-x	R/W-x	R/W-x
SID5	SID4	SID3	SID2	SID1	SID0	SRR	IDE
bit 7							bit 0

Legend:

R = Readable bit W = Writable bit U = Unimplemented bit, read as '0'
 -n = Value at POR '1' = Bit is set '0' = Bit is cleared x = Bit is unknown

- bit 15-13 **Unimplemented:** Read as '0'
- bit 12-2 **SID<10:0>:** Standard Identifier bits
- bit 1 **SRR:** Substitute Remote Request bit
 - 1 = Message will request remote transmission
 - 0 = Normal message
- bit 0 **IDE:** Extended Identifier bit
 - 1 = Message will transmit extended identifier
 - 0 = Message will transmit standard identifier

BUFFER 19-2: ECAN™ MESSAGE BUFFER WORD 1

U-0	U-0	U-0	U-0	R/W-x	R/W-x	R/W-x	R/W-x
—	—	—	—	EID17	EID16	EID15	EID14
bit 15							bit 8

R/W-x	R/W-x	R/W-x	R/W-x	R/W-x	R/W-x	R/W-x	R/W-x
EID13	EID12	EID11	EID10	EID9	EID8	EID7	EID6
bit 7							bit 0

Legend:

R = Readable bit W = Writable bit U = Unimplemented bit, read as '0'
 -n = Value at POR '1' = Bit is set '0' = Bit is cleared x = Bit is unknown

- bit 15-12 **Unimplemented:** Read as '0'
- bit 11-0 **EID<17:6>:** Extended Identifier bits

PIC24HJ32GP302/304, PIC24HJ64GPX02/X04 AND PIC24HJ128GPX02/X04

BUFFER 19-3: ECAN™ MESSAGE BUFFER WORD 2

R/W-x	R/W-x	R/W-x	R/W-x	R/W-x	R/W-x	R/W-x	R/W-x
EID5	EID4	EID3	EID2	EID1	EID0	RTR	RB1
bit 15							bit 8

U-0	U-0	U-0	R/W-x	R/W-x	R/W-x	R/W-x	R/W-x
—	—	—	RB0	DLC3	DLC2	DLC1	DLC0
bit 7							bit 0

Legend:

R = Readable bit W = Writable bit U = Unimplemented bit, read as '0'
 -n = Value at POR '1' = Bit is set '0' = Bit is cleared x = Bit is unknown

- bit 15-10 **EID<5:0>**: Extended Identifier bits
- bit 9 **RTR**: Remote Transmission Request bit
 1 = Message will request remote transmission
 0 = Normal message
- bit 8 **RB1**: Reserved Bit 1
 User must set this bit to '0' per CAN protocol.
- bit 7-5 **Unimplemented**: Read as '0'
- bit 4 **RB0**: Reserved Bit 0
 User must set this bit to '0' per CAN protocol.
- bit 3-0 **DLC<3:0>**: Data Length Code bits

BUFFER 19-4: ECAN™ MESSAGE BUFFER WORD 3

R/W-x	R/W-x	R/W-x	R/W-x	R/W-x	R/W-x	R/W-x	R/W-x
Byte 1							
bit 15							bit 8

R/W-x	R/W-x	R/W-x	R/W-x	R/W-x	R/W-x	R/W-x	R/W-x
Byte 0							
bit 7							bit 0

Legend:

R = Readable bit W = Writable bit U = Unimplemented bit, read as '0'
 -n = Value at POR '1' = Bit is set '0' = Bit is cleared x = Bit is unknown

- bit 15-8 **Byte 1<15:8>**: ECAN™ Message Byte 0
- bit 7-0 **Byte 0<7:0>**: ECAN Message Byte 1

BUFFER 19-5: ECAN™ MESSAGE BUFFER WORD 4

R/W-x	R/W-x	R/W-x	R/W-x	R/W-x	R/W-x	R/W-x	R/W-x
Byte 3							
bit 15				bit 8			
R/W-x	R/W-x	R/W-x	R/W-x	R/W-x	R/W-x	R/W-x	R/W-x
Byte 2							
bit 7				bit 0			
Legend:							
R = Readable bit		W = Writable bit		U = Unimplemented bit, read as '0'			
-n = Value at POR		'1' = Bit is set		'0' = Bit is cleared		x = Bit is unknown	

bit 15-8 **Byte 3<15:8>**: ECAN™ Message Byte 3
bit 7-0 **Byte 2<7:0>**: ECAN Message Byte 2

BUFFER 19-6: ECAN™ MESSAGE BUFFER WORD 5

R/W-x	R/W-x	R/W-x	R/W-x	R/W-x	R/W-x	R/W-x	R/W-x
Byte 5							
bit 15				bit 8			
R/W-x	R/W-x	R/W-x	R/W-x	R/W-x	R/W-x	R/W-x	R/W-x
Byte 4							
bit 7				bit 0			
Legend:							
R = Readable bit		W = Writable bit		U = Unimplemented bit, read as '0'			
-n = Value at POR		'1' = Bit is set		'0' = Bit is cleared		x = Bit is unknown	

bit 15-8 **Byte 5<15:8>**: ECAN™ Message Byte 5
bit 7-0 **Byte 4<7:0>**: ECAN Message Byte 4

PIC24HJ32GP302/304, PIC24HJ64GPX02/X04 AND PIC24HJ128GPX02/X04

BUFFER 19-7: ECAN™ MESSAGE BUFFER WORD 6

R/W-x	R/W-x	R/W-x	R/W-x	R/W-x	R/W-x	R/W-x	R/W-x
Byte 7							
bit 15							
bit 8							

R/W-x	R/W-x	R/W-x	R/W-x	R/W-x	R/W-x	R/W-x	R/W-x
Byte 6							
bit 7							
bit 0							

Legend:

R = Readable bit W = Writable bit U = Unimplemented bit, read as '0'
 -n = Value at POR '1' = Bit is set '0' = Bit is cleared x = Bit is unknown

bit 15-8 **Byte 7<15:8>**: ECAN™ Message Byte 7

bit 7-0 **Byte 6<7:0>**: ECAN Message Byte 6

BUFFER 19-8: ECAN™ MESSAGE BUFFER WORD 7

U-0	U-0	U-0	R/W-x	R/W-x	R/W-x	R/W-x	R/W-x
—	—	—	FILHIT<4:0> ⁽¹⁾				
bit 15							
bit 8							

U-0	U-0	U-0	U-0	U-0	U-0	U-0	U-0
—	—	—	—	—	—	—	—
bit 7							
bit 0							

Legend:

R = Readable bit W = Writable bit U = Unimplemented bit, read as '0'
 -n = Value at POR '1' = Bit is set '0' = Bit is cleared x = Bit is unknown

bit 15-13 **Unimplemented:** Read as '0'

bit 12-8 **FILHIT<4:0>**: Filter Hit Code bits⁽¹⁾
 Encodes number of filter that resulted in writing this buffer.

bit 7-0 **Unimplemented:** Read as '0'

Note 1: Only written by module for receive buffers, unused for transmit buffers.

20.0 10-BIT/12-BIT ANALOG-TO-DIGITAL CONVERTER (ADC1)

Note 1: This data sheet summarizes the features of the PIC24HJ32GP302/304, PIC24HJ64GPX02/X04 and PIC24HJ128GPX02/X04 families of devices. It is not intended to be a comprehensive reference source. To complement the information in this data sheet, refer to **Section 16. “Analog-to-Digital Converter (ADC)”** (DS70183) of the “*dsPIC33F/PIC24H Family Reference Manual*”, which is available from the Microchip web site (www.microchip.com).

2: Some registers and associated bits described in this section may not be available on all devices. Refer to **Section 4.0 “Memory Organization”** in this data sheet for device-specific register and bit information.

The PIC24HJ32GP302/304, PIC24HJ64GPX02/X04 and PIC24HJ128GPX02/X04 devices have up to 13 ADC input channels.

The AD12B bit (AD1CON1<10>) allows each of the ADC modules to be configured by the user as either a 10-bit, 4-sample/hold ADC (default configuration) or a 12-bit, 1-sample/hold ADC.

Note: The ADC module needs to be disabled before modifying the AD12B bit.

20.1 Key Features

The 10-bit ADC configuration has the following key features:

- Successive Approximation (SAR) conversion
- Conversion speeds of up to 1.1 Msps
- Up to 13 analog input pins
- External voltage reference input pins
- Simultaneous sampling of up to four analog input pins
- Automatic Channel Scan mode
- Selectable conversion trigger source
- Selectable Buffer Fill modes
- Operation during CPU Sleep and Idle modes

The 12-bit ADC configuration supports all the above features, except:

- In the 12-bit configuration, conversion speeds of up to 500 ksps are supported
- There is only one sample/hold amplifier in the 12-bit configuration, so simultaneous sampling of multiple channels is not supported.

Depending on the particular device pinout, the ADC can have up to 13 analog input pins, designated AN0 through AN12. In addition, there are two analog input pins for external voltage reference connections. These voltage reference inputs can be shared with other analog input pins. The actual number of analog input pins and external voltage reference input configuration depends on the specific device.

Block diagrams of the ADC module are shown in [Figure 20-1](#) and [Figure 20-2](#).

20.2 ADC Initialization

The following configuration steps should be performed.

1. Configure the ADC module:
 - a) Select port pins as analog inputs (AD1PCFGH<15:0> or AD1PCFGL<15:0>)
 - b) Select voltage reference source to match expected range on analog inputs (AD1CON2<15:13>)
 - c) Select the analog conversion clock to match desired data rate with processor clock (AD1CON3<7:0>)
 - d) Determine how many S/H channels are used (AD1CON2<9:8> and AD1PCFGH<15:0> or AD1PCFGL<15:0>)
 - e) Select the appropriate sample/conversion sequence (AD1CON1<7:5> and AD1CON3<12:8>)
 - f) Select how conversion results are presented in the buffer (AD1CON1<9:8>)
 - g) Turn on ADC module (AD1CON1<15>)
2. Configure ADC interrupt (if required):
 - a) Clear the AD1IF bit
 - b) Select ADC interrupt priority

20.3 ADC and DMA

If more than one conversion result needs to be buffered before triggering an interrupt, DMA data transfers can be used. ADC1 can trigger a DMA data transfer. If ADC1 is selected as the DMA IRQ source, a DMA transfer occurs when the AD1IF bit gets set as a result of an ADC1 sample conversion sequence.

The SMPI<3:0> bits (AD1CON2<5:2>) are used to select how often the DMA RAM buffer pointer is incremented.

The ADDMABM bit (AD1CON1<12>) determines how the conversion results are filled in the DMA RAM buffer area being used for ADC. If this bit is set, DMA buffers are written in the order of conversion. The module provides an address to the DMA channel that is the same as the address used for the non-DMA stand-alone buffer. If the ADDMABM bit is cleared, then DMA buffers are written in Scatter/Gather mode. The module provides a scatter/gather address to the DMA channel, based on the index of the analog input and the size of the DMA buffer.

FIGURE 20-1: ADC1 MODULE BLOCK DIAGRAM FOR PIC24HJ32GP304, PIC24HJ64GP204/504 AND PIC24HJ128GP204/504 DEVICES



FIGURE 20-2: ADC1 MODULE BLOCK DIAGRAM FOR PIC24HJ32GP302, PIC24HJ64GP202/502 AND PIC24HJ128GP202/502 DEVICES



FIGURE 20-3: ADC CONVERSION CLOCK PERIOD BLOCK DIAGRAM



20.4 ADC Helpful Tips

1. The SMPI<3:0> (AD1CON2<5:2>) control bits:
 - a) Determine when the ADC interrupt flag is set and an interrupt is generated if enabled.
 - b) When the CSCNA bit (AD1CON2<10>) is set to '1', determines when the ADC analog scan channel list defined in the AD1CSSL/AD1CSSH registers starts over from the beginning.
 - c) On devices without a DMA peripheral, determines when ADC result buffer pointer to ADC1BUF0-ADC1BUFF, gets reset back to the beginning at ADC1BUF0.
2. On devices without a DMA module, the ADC has 16 result buffers. ADC conversion results are stored sequentially in ADC1BUF0-ADC1BUFF regardless of which analog inputs are being used subject to the SMPI<3:0> bits (AD1CON2<5:2>) and the condition described in 1c above. There is no relationship between the ANx input being measured and which ADC buffer (ADC1BUF0-ADC1BUFF) that the conversion results will be placed in.
3. On devices with a DMA module, the ADC module has only 1 ADC result buffer, (i.e., ADC1BUF0), per ADC peripheral and the ADC conversion result must be read either by the CPU or DMA controller before the next ADC conversion is complete to avoid overwriting the previous value.
4. The DONE bit (AD1CON1<0>) is only cleared at the start of each conversion and is set at the completion of the conversion, but remains set indefinitely even through the next sample phase until the next conversion begins. If application code is monitoring the DONE bit in any kind of software loop, the user must consider this behavior because the CPU code execution is faster than the ADC. As a result, in manual sample mode, particularly where the users code is setting the SAMP bit (AD1CON1<1>), the DONE bit should also be cleared by the user application just before setting the SAMP bit.
5. On devices with two ADC modules, the ADCxPCFG registers for both ADC modules must be set to a logic '1' to configure a target I/O pin as a digital I/O pin. Failure to do so means that any alternate digital input function will always see only a logic '0' as the digital input buffer is held in Disable mode.

20.5 ADC Resources

Many useful resources related to ADC are provided on the main product page of the Microchip web site for the devices listed in this data sheet. This product page, which can be accessed using this [link](#), contains the latest updates and additional information.

Note: In the event you are not able to access the product page using the link above, enter this URL in your browser:
<http://www.microchip.com/wwwproducts/Devices.aspx?dDoc-Name=en534555>

20.5.1 KEY RESOURCES

- **Section 16. “Analog-to-Digital Converter (ADC)”** (DS70183)
- Code Samples
- Application Notes
- Software Libraries
- Webinars
- All related dsPIC33F/PIC24H Family Reference Manuals Sections
- Development Tools

20.6 ADC Control Registers

REGISTER 20-1: AD1CON1: ADC1 CONTROL REGISTER 1

R/W-0	U-0	R/W-0	R/W-0	U-0	R/W-0	R/W-0	R/W-0
ADON	—	ADSIDL	ADDMABM	—	AD12B	FORM<1:0>	
bit 15						bit 8	

R/W-0	R/W-0	R/W-0	U-0	R/W-0	R/W-0	R/W-0 HC,HS	R/C-0 HC, HS
SSRC<2:0>			—	SIMSAM	ASAM	SAMP	DONE
bit 7						bit 0	

Legend:	HC = Cleared by hardware	HS = Set by hardware	C = Clear only bit
R = Readable bit	W = Writable bit	U = Unimplemented bit, read as '0'	
-n = Value at POR	'1' = Bit is set	'0' = Bit is cleared	x = Bit is unknown

- bit 15 **ADON:** ADC Operating Mode bit
 1 = ADC module is operating
 0 = ADC is off
- bit 14 **Unimplemented:** Read as '0'
- bit 13 **ADSIDL:** Stop in Idle Mode bit
 1 = Discontinue module operation when device enters Idle mode
 0 = Continue module operation in Idle mode
- bit 12 **ADDMABM:** DMA Buffer Build Mode bit
 1 = DMA buffers are written in the order of conversion. The module provides an address to the DMA channel that is the same as the address used for the non-DMA stand-alone buffer
 0 = DMA buffers are written in Scatter/Gather mode. The module provides a scatter/gather address to the DMA channel, based on the index of the analog input and the size of the DMA buffer
- bit 11 **Unimplemented:** Read as '0'
- bit 10 **AD12B:** 10-bit or 12-bit Operation Mode bit
 1 = 12-bit, 1-channel ADC operation
 0 = 10-bit, 4-channel ADC operation
- bit 9-8 **FORM<1:0>:** Data Output Format bits
For 10-bit operation:
 11 = Reserved
 10 = Reserved
 01 = Signed integer (DOUT = ssss sssd dddd dddd, where s = .NOT.d<9>)
 00 = Integer (DOUT = 0000 00dd dddd dddd)
For 12-bit operation:
 11 = Reserved
 10 = Reserved
 01 = Signed Integer (DOUT = ssss sddd dddd dddd, where s = .NOT.d<11>)
 00 = Integer (DOUT = 0000 dddd dddd dddd)
- bit 7-5 **SSRC<2:0>:** Sample Clock Source Select bits
 111 = Internal counter ends sampling and starts conversion (auto-convert)
 110 = Reserved
 101 = Reserved
 100 = GP timer (Timer5 for ADC1) compare ends sampling and starts conversion
 011 = Reserved
 010 = GP timer (Timer3 for ADC1) compare ends sampling and starts conversion
 001 = Active transition on INT0 pin ends sampling and starts conversion
 000 = Clearing sample bit ends sampling and starts conversion
- bit 4 **Unimplemented:** Read as '0'

REGISTER 20-1: AD1CON1: ADC1 CONTROL REGISTER 1 (CONTINUED)

- bit 3 **SIMSAM:** Simultaneous Sample Select bit (only applicable when CHPS<1:0> = 01 or 1x)
When AD12B = 1, SIMSAM is: U-0, Unimplemented, Read as '0'
1 = Samples CH0, CH1, CH2, CH3 simultaneously (when CHPS<1:0> = 1x); or
 Samples CH0 and CH1 simultaneously (when CHPS<1:0> = 01)
0 = Samples multiple channels individually in sequence
- bit 2 **ASAM:** ADC Sample Auto-Start bit
1 = Sampling begins immediately after last conversion. SAMP bit is auto-set
0 = Sampling begins when SAMP bit is set
- bit 1 **SAMP:** ADC Sample Enable bit
1 = ADC sample/hold amplifiers are sampling
0 = ADC sample/hold amplifiers are holding
If ASAM = 0, software can write '1' to begin sampling. Automatically set by hardware if ASAM = 1.
If SSRC = 000, software can write '0' to end sampling and start conversion. If SSRC ≠ 000,
automatically cleared by hardware to end sampling and start conversion.
- bit 0 **DONE:** ADC Conversion Status bit
1 = ADC conversion cycle is completed
0 = ADC conversion not started or in progress
Automatically set by hardware when ADC conversion is complete. Software can write '0' to clear
DONE status (software not allowed to write '1'). Clearing this bit does NOT affect any operation in
progress. Automatically cleared by hardware at start of a new conversion.

PIC24HJ32GP302/304, PIC24HJ64GPX02/X04 AND PIC24HJ128GPX02/X04

REGISTER 20-2: AD1CON2: ADC1 CONTROL REGISTER 2

R/W-0	R/W-0	R/W-0	U-0	U-0	R/W-0	R/W-0	R/W-0	
VCFG<2:0>			—	—	CSCNA	CHPS<1:0>		
bit 15								bit 8

R-0	U-0	R/W-0	R/W-0	R/W-0	R/W-0	R/W-0	R/W-0	
BUFS	—	SMPI<3:0>				BUFM	ALTS	
bit 7								bit 0

Legend:

R = Readable bit W = Writable bit U = Unimplemented bit, read as '0'
 -n = Value at POR '1' = Bit is set '0' = Bit is cleared x = Bit is unknown

bit 15-13 **VCFG<2:0>**: Converter Voltage Reference Configuration bits

	ADREF+	ADREF-
000	AVDD	AVSS
001	External VREF+	AVSS
010	AVDD	External VREF-
011	External VREF+	External VREF-
1xx	AVDD	AVSS

bit 12-11 **Unimplemented**: Read as '0'

bit 10 **CSCNA**: Scan Input Selections for CH0+ during Sample A bit

1 = Scan inputs
 0 = Do not scan inputs

bit 9-8 **CHPS<1:0>**: Selects Channels Utilized bits

When AD12B = 1, CHPS<1:0> is: U-0, Unimplemented, Read as '0'

1x = Converts CH0, CH1, CH2 and CH3
 01 = Converts CH0 and CH1
 00 = Converts CH0

bit 7 **BUFS**: Buffer Fill Status bit (only valid when BUFM = 1)

1 = ADC is currently filling buffer 0x8-0xF, user should access data in 0x0-0x7
 0 = ADC is currently filling buffer 0x0-0x7, user should access data in 0x8-0xF

bit 6 **Unimplemented**: Read as '0'

bit 5-2 **SMPI<3:0>**: Selects Increment Rate for DMA Addresses bits or number of sample/conversion operations per interrupt

1111 = Increments the DMA address or generates interrupt after completion of every 16th sample/conversion operation
 1110 = Increments the DMA address or generates interrupt after completion of every 15th sample/conversion operation

•
 •
 •

0001 = Increments the DMA address after completion of every 2nd sample/conversion operation
 0000 = Increments the DMA address after completion of every sample/conversion operation

bit 1 **BUFM**: Buffer Fill Mode Select bit

1 = Starts buffer filling at address 0x0 on first interrupt and 0x8 on next interrupt
 0 = Always starts filling buffer at address 0x0

bit 0 **ALTS**: Alternate Input Sample Mode Select bit

1 = Uses channel input selects for Sample A on first sample and Sample B on next sample
 0 = Always uses channel input selects for Sample A

REGISTER 20-3: AD1CON3: ADC1 CONTROL REGISTER 3

R/W-0	U-0	U-0	R/W-0	R/W-0	R/W-0	R/W-0	R/W-0
ADRC	—	—	SAMC<4:0> ⁽¹⁾				
bit 15							bit 8

R/W-0	R/W-0	R/W-0	R/W-0	R/W-0	R/W-0	R/W-0	R/W-0
ADCS<7:0> ⁽²⁾							
bit 7							bit 0

Legend:			
R = Readable bit	W = Writable bit	U = Unimplemented bit, read as '0'	
-n = Value at POR	'1' = Bit is set	'0' = Bit is cleared	x = Bit is unknown

bit 15 **ADRC:** ADC Conversion Clock Source bit
 1 = ADC internal RC clock
 0 = Clock derived from system clock

bit 14-13 **Unimplemented:** Read as '0'

bit 12-8 **SAMC<4:0>:** Auto Sample Time bits⁽¹⁾
 11111 = 31 TAD
 •
 •
 •
 00001 = 1 TAD
 00000 = 0 TAD

bit 7-0 **ADCS<7:0>:** ADC Conversion Clock Select bits⁽²⁾
 11111111 = Reserved
 •
 •
 •
 •
 01000000 = Reserved
 00111111 = $T_{CY} \cdot (ADCS<7:0> + 1) = 64 \cdot T_{CY} = TAD$
 •
 •
 •
 00000010 = $T_{CY} \cdot (ADCS<7:0> + 1) = 3 \cdot T_{CY} = TAD$
 00000001 = $T_{CY} \cdot (ADCS<7:0> + 1) = 2 \cdot T_{CY} = TAD$
 00000000 = $T_{CY} \cdot (ADCS<7:0> + 1) = 1 \cdot T_{CY} = TAD$

Note 1: This bit only used if AD1CON1<7:5> (SSRC<2:0>) = 111.
2: This bit is not used if AD1CON3<15> (ADRC) = 1.

PIC24HJ32GP302/304, PIC24HJ64GPX02/X04 AND PIC24HJ128GPX02/X04

REGISTER 20-4: AD1CON4: ADC1 CONTROL REGISTER 4

U-0	U-0	U-0	U-0	U-0	U-0	U-0	U-0
—	—	—	—	—	—	—	—
bit 15							bit 8

U-0	U-0	U-0	U-0	U-0	R/W-0	R/W-0	R/W-0
—	—	—	—	—	DMABL<2:0>		
bit 7						bit 0	

Legend:

R = Readable bit W = Writable bit U = Unimplemented bit, read as '0'
 -n = Value at POR '1' = Bit is set '0' = Bit is cleared x = Bit is unknown

- bit 15-3 **Unimplemented:** Read as '0'
- bit 2-0 **DMABL<2:0>:** Selects Number of DMA Buffer Locations per Analog Input bits
 - 111 = Allocates 128 words of buffer to each analog input
 - 110 = Allocates 64 words of buffer to each analog input
 - 101 = Allocates 32 words of buffer to each analog input
 - 100 = Allocates 16 words of buffer to each analog input
 - 011 = Allocates 8 words of buffer to each analog input
 - 010 = Allocates 4 words of buffer to each analog input
 - 001 = Allocates 2 words of buffer to each analog input
 - 000 = Allocates 1 word of buffer to each analog input

REGISTER 20-5: AD1CHS123: ADC1 INPUT CHANNEL 1, 2, 3 SELECT REGISTER

U-0	U-0	U-0	U-0	U-0	R/W-0	R/W-0	R/W-0
—	—	—	—	—	CH123NB<1:0>		CH123SB
bit 15						bit 8	

U-0	U-0	U-0	U-0	U-0	R/W-0	R/W-0	R/W-0
—	—	—	—	—	CH123NA<1:0>		CH123SA
bit 7						bit 0	

Legend:			
R = Readable bit	W = Writable bit	U = Unimplemented bit, read as '0'	
-n = Value at POR	'1' = Bit is set	'0' = Bit is cleared	x = Bit is unknown

- bit 15-11 **Unimplemented:** Read as '0'
- bit 10-9 **CH123NB<1:0>:** Channel 1, 2, 3 Negative Input Select for Sample B bits
When AD12B = 1, CHxNB is: U-0, Unimplemented, Read as '0'
 11 = CH1 negative input is AN9, CH2 negative input is AN10, CH3 negative input is AN11
 10 = CH1 negative input is AN6, CH2 negative input is AN7, CH3 negative input is AN8⁽¹⁾
 0x = CH1, CH2, CH3 negative input is VREF-
- bit 8 **CH123SB:** Channel 1, 2, 3 Positive Input Select for Sample B bit
When AD12B = 1, CHxSA is: U-0, Unimplemented, Read as '0'
 1 = CH1 positive input is AN3, CH2 positive input is AN4, CH3 positive input is AN5
 0 = CH1 positive input is AN0, CH2 positive input is AN1, CH3 positive input is AN2
- bit 7-3 **Unimplemented:** Read as '0'
- bit 2-1 **CH123NA<1:0>:** Channel 1, 2, 3 Negative Input Select for Sample A bits
When AD12B = 1, CHxNA is: U-0, Unimplemented, Read as '0'
 11 = CH1 negative input is AN9, CH2 negative input is AN10, CH3 negative input is AN11
 10 = CH1 negative input is AN6, CH2 negative input is AN7, CH3 negative input is AN8⁽¹⁾
 0x = CH1, CH2, CH3 negative input is VREF-
- bit 0 **CH123SA:** Channel 1, 2, 3 Positive Input Select for Sample A bit
When AD12B = 1, CHxSA is: U-0, Unimplemented, Read as '0'
 1 = CH1 positive input is AN3, CH2 positive input is AN4, CH3 positive input is AN5
 0 = CH1 positive input is AN0, CH2 positive input is AN1, CH3 positive input is AN2

Note 1: This bit setting is Reserved in PIC24HJ128GPX02, PIC24HJ64GPX02 and PIC24HJ32GPX02 (28-pin) devices.

PIC24HJ32GP302/304, PIC24HJ64GPX02/X04 AND PIC24HJ128GPX02/X04

REGISTER 20-6: AD1CHS0: ADC1 INPUT CHANNEL 0 SELECT REGISTER

R/W-0	U-0	U-0	R/W-0	R/W-0	R/W-0	R/W-0	R/W-0
CH0NB	—	—	CH0SB<4:0>				
bit 15							bit 8

R/W-0	U-0	U-0	R/W-0	R/W-0	R/W-0	R/W-0	R/W-0
CH0NA	—	—	CH0SA<4:0>				
bit 7							bit 0

Legend:

R = Readable bit W = Writable bit U = Unimplemented bit, read as '0'
 -n = Value at POR '1' = Bit is set '0' = Bit is cleared x = Bit is unknown

- bit 15 **CH0NB:** Channel 0 Negative Input Select for Sample B bit
Same definition as bit 7.
- bit 14-13 **Unimplemented:** Read as '0'
- bit 12-8 **CH0SB<4:0>:** Channel 0 Positive Input Select for Sample B bits
 01100 = Channel 0 positive input is AN12
 01011 = Channel 0 positive input is AN11
 •
 •
 •
 01000 = Channel 0 positive input is AN8⁽¹⁾
 00111 = Channel 0 positive input is AN7⁽¹⁾
 00110 = Channel 0 positive input is AN6⁽¹⁾
 •
 •
 •
 00010 = Channel 0 positive input is AN2
 00001 = Channel 0 positive input is AN1
 00000 = Channel 0 positive input is AN0
- bit 7 **CH0NA:** Channel 0 Negative Input Select for Sample A bit
 1 = Channel 0 negative input is AN1
 0 = Channel 0 negative input is VREF-
- bit 6-5 **Unimplemented:** Read as '0'
- bit 4-0 **CH0SA<4:0>:** Channel 0 Positive Input Select for Sample A bits
 01100 = Channel 0 positive input is AN12
 01011 = Channel 0 positive input is AN11
 •
 •
 •
 01000 = Channel 0 positive input is AN8⁽¹⁾
 00111 = Channel 0 positive input is AN7⁽¹⁾
 00110 = Channel 0 positive input is AN6⁽¹⁾
 •
 •
 •
 00010 = Channel 0 positive input is AN2
 00001 = Channel 0 positive input is AN1
 00000 = Channel 0 positive input is AN0

Note 1: These bit settings (AN6, AN7 and AN8) are reserved on PIC24HJ128GPX02, PIC24HJ64GPX02 and PIC24HJ32GPX02 (28-pin) devices.

REGISTER 20-7: AD1CSSL: ADC1 INPUT SCAN SELECT REGISTER LOW^(1,2)

U-0	U-0	U-0	R/W-0	R/W-0	R/W-0	R/W-0	R/W-0
—	—	—	CSS12	CSS11	CSS10	CSS9	CSS8
bit 15							bit 8
R/W-0	R/W-0	R/W-0	R/W-0	R/W-0	R/W-0	R/W-0	R/W-0
CSS7	CSS6	CSS5	CSS4	CSS3	CSS2	CSS1	CSS0
bit 7							bit 0

Legend:
 R = Readable bit W = Writable bit U = Unimplemented bit, read as '0'
 -n = Value at POR '1' = Bit is set '0' = Bit is cleared x = Bit is unknown

bit 15-13 **Unimplemented:** Read as '0'
 bit 12-0 **CSS<12:0>:** ADC Input Scan Selection bits
 1 = Select ANx for input scan
 0 = Skip ANx for input scan

- Note 1:** On devices without 13 analog inputs, all AD1CSSL bits can be selected by user application. However, inputs selected for scan without a corresponding input on device converts VREF-.
- 2:** CSSx = ANx, where x = 0 through 12.

REGISTER 20-8: AD1PCFGL: ADC1 PORT CONFIGURATION REGISTER LOW^(1,2,3)

U-0	U-0	U-0	R/W-0	R/W-0	R/W-0	R/W-0	R/W-0
—	—	—	PCFG12	PCFG11	PCFG10	PCFG9	PCFG8
bit 15							bit 8
R/W-0	R/W-0	R/W-0	R/W-0	R/W-0	R/W-0	R/W-0	R/W-0
PCFG7	PCFG6	PCFG5	PCFG4	PCFG3	PCFG2	PCFG1	PCFG0
bit 7							bit 0

Legend:
 R = Readable bit W = Writable bit U = Unimplemented bit, read as '0'
 -n = Value at POR '1' = Bit is set '0' = Bit is cleared x = Bit is unknown

bit 15-13 **Unimplemented:** Read as '0'
 bit 12-0 **PCFG<12:0>:** ADC Port Configuration Control bits
 1 = Port pin in Digital mode, port read input enabled, ADC input multiplexer connected to AVss
 0 = Port pin in Analog mode, port read input disabled, ADC samples pin voltage

- Note 1:** On devices without 13 analog inputs, all PCFG bits are R/W by user. However, PCFG bits are ignored on ports without a corresponding input on device.
- 2:** PCFGx = ANx, where x = 0 through 12.
- 3:** PCFGx bits have no effect if ADC module is disabled by setting ADxMD bit in the PMDx register. In this case, all port pins multiplexed with ANx will be in Digital mode.

NOTES:

21.0 COMPARATOR MODULE

Note 1: This data sheet summarizes the features of the PIC24HJ32GP302/304, PIC24HJ64GPX02/X04 and PIC24HJ128GPX02/X04 families of devices. It is not intended to be a comprehensive reference source. To complement the information in this data sheet, refer to **Section 34. “Comparator”** (DS70212) of the “*dsPIC33F/PIC24H Family Reference Manual*”, which is available from the Microchip web site (www.microchip.com).

2: Some registers and associated bits described in this section may not be available on all devices. Refer to **Section 4.0 “Memory Organization”** in this data sheet for device-specific register and bit information.

The Comparator module provides a set of dual input comparators. The inputs to the comparator can be configured to use any one of the four pin inputs (C1IN+, C1IN-, C2IN+ and C2IN-) as well as the Comparator Voltage Reference Input (CVREF).

Note: This peripheral contains output functions that may need to be configured by the peripheral pin select feature. For more information, see **Section 11.6 “Peripheral Pin Select”**.

FIGURE 21-1: COMPARATOR I/O OPERATING MODES



Note 1: This peripheral's outputs must be assigned to an available RPN pin before use. Refer to **Section 11.6 “Peripheral Pin Select”** for more information.

21.1 Comparator Resources

Many useful resources related to Comparators are provided on the main product page of the Microchip web site for the devices listed in this data sheet. This product page, which can be accessed using this [link](#), contains the latest updates and additional information.

Note: In the event you are not able to access the product page using the link above, enter this URL in your browser:
<http://www.microchip.com/wwwproducts/Devices.aspx?dDocName=en534555>

21.1.1 KEY RESOURCES

- **Section 34. “Comparator”** (DS70212)
- Code Samples
- Application Notes
- Software Libraries
- Webinars
- All related dsPIC33F/PIC24H Family Reference Manuals Sections
- Development Tools

21.2 Comparator Control Register

REGISTER 21-1: CMCON: COMPARATOR CONTROL REGISTER

R/W-0	U-0	R/W-0	R/W-0	R/W-0	R/W-0	R/W-0	R/W-0
CMIDL	—	C2EVT	C1EVT	C2EN	C1EN	C2OUTEN ⁽¹⁾	C1OUTEN ⁽²⁾
bit 15						bit 8	

R-0	R-0	R/W-0	R/W-0	R/W-0	R/W-0	R/W-0	R/W-0
C2OUT	C1OUT	C2INV	C1INV	C2NEG	C2POS	C1NEG	C1POS
bit 7						bit 0	

Legend:

R = Readable bit	W = Writable bit	U = Unimplemented bit, read as '0'
-n = Value at POR	'1' = Bit is set	'0' = Bit is cleared
		x = Bit is unknown

- bit 15 **CMIDL:** Stop in Idle Mode
 1 = When device enters Idle mode, module does not generate interrupts. Module is still enabled
 0 = Continue normal module operation in Idle mode
- bit 14 **Unimplemented:** Read as '0'
- bit 13 **C2EVT:** Comparator 2 Event
 1 = Comparator output changed states
 0 = Comparator output did not change states
- bit 12 **C1EVT:** Comparator 1 Event
 1 = Comparator output changed states
 0 = Comparator output did not change states
- bit 11 **C2EN:** Comparator 2 Enable
 1 = Comparator is enabled
 0 = Comparator is disabled
- bit 10 **C1EN:** Comparator 1 Enable
 1 = Comparator is enabled
 0 = Comparator is disabled
- bit 9 **C2OUTEN:** Comparator 2 Output Enable⁽¹⁾
 1 = Comparator output is driven on the output pad
 0 = Comparator output is not driven on the output pad
- bit 8 **C1OUTEN:** Comparator 1 Output Enable⁽²⁾
 1 = Comparator output is driven on the output pad
 0 = Comparator output is not driven on the output pad
- bit 7 **C2OUT:** Comparator 2 Output bit
 When C2INV = 0:
 1 = C2 VIN+ > C2 VIN-
 0 = C2 VIN+ < C2 VIN-
 When C2INV = 1:
 0 = C2 VIN+ > C2 VIN-
 1 = C2 VIN+ < C2 VIN-

- Note 1:** If C2OUTEN = 1, the C2OUT peripheral output must be configured to an available RPx pin. See [Section 11.6 “Peripheral Pin Select”](#) for more information.
- 2:** If C1OUTEN = 1, the C1OUT peripheral output must be configured to an available RPx pin. See [Section 11.6 “Peripheral Pin Select”](#) for more information.

REGISTER 21-1: CMCON: COMPARATOR CONTROL REGISTER (CONTINUED)

- bit 6 **C1OUT:** Comparator 1 Output bit
 When C1INV = 0:
 1 = C1 VIN+ > C1 VIN-
 0 = C1 VIN+ < C1 VIN-
 When C1INV = 1:
 0 = C1 VIN+ > C1 VIN-
 1 = C1 VIN+ < C1 VIN-
- bit 5 **C2INV:** Comparator 2 Output Inversion bit
 1 = C2 output inverted
 0 = C2 output not inverted
- bit 4 **C1INV:** Comparator 1 Output Inversion bit
 1 = C1 output inverted
 0 = C1 output not inverted
- bit 3 **C2NEG:** Comparator 2 Negative Input Configure bit
 1 = Input is connected to VIN+
 0 = Input is connected to VIN-
 See [Figure 21-1](#) for the comparator modes.
- bit 2 **C2POS:** Comparator 2 Positive Input Configure bit
 1 = Input is connected to VIN+
 0 = Input is connected to CVREF
 See [Figure 21-1](#) for the comparator modes.
- bit 1 **C1NEG:** Comparator 1 Negative Input Configure bit
 1 = Input is connected to VIN+
 0 = Input is connected to VIN-
 See [Figure 21-1](#) for the comparator modes.
- bit 0 **C1POS:** Comparator 1 Positive Input Configure bit
 1 = Input is connected to VIN+
 0 = Input is connected to CVREF
 See [Figure 21-1](#) for the comparator modes.

- Note 1:** If C2OUTEN = 1, the C2OUT peripheral output must be configured to an available RPx pin. See [Section 11.6 “Peripheral Pin Select”](#) for more information.
- 2:** If C1OUTEN = 1, the C1OUT peripheral output must be configured to an available RPx pin. See [Section 11.6 “Peripheral Pin Select”](#) for more information.

21.3 Comparator Voltage Reference

21.3.1 CONFIGURING THE COMPARATOR VOLTAGE REFERENCE

The Voltage Reference module is controlled through the CVRCON register (Register 21-2). The comparator voltage reference provides two ranges of output voltage, each with 16 distinct levels. The range to be used is selected by the CVRR bit (CVRCON<5>). The primary difference between the ranges is the size of the steps selected by the CVREF Selection bits (CVR3:CVR0), with one range offering finer resolution.

The comparator reference supply voltage can come from either VDD and VSS, or the external VREF+ and VREF-. The voltage source is selected by the CVRSS bit (CVRCON<4>).

The settling time of the comparator voltage reference must be considered when changing the CVREF output.

FIGURE 21-2: COMPARATOR VOLTAGE REFERENCE BLOCK DIAGRAM



PIC24HJ32GP302/304, PIC24HJ64GPX02/X04 AND PIC24HJ128GPX02/X04

REGISTER 21-2: CVRCON: COMPARATOR VOLTAGE REFERENCE CONTROL REGISTER

U-0	U-0	U-0	U-0	U-0	U-0	U-0	U-0
—	—	—	—	—	—	—	—
bit 15							bit 8

R/W-0	R/W-0	R/W-0	R/W-0	R/W-0	R/W-0	R/W-0	R/W-0
CVREN	CVROE	CVRR	CVRSS	CVR<3:0>			
bit 7							bit 0

Legend:

R = Readable bit

W = Writable bit

U = Unimplemented bit, read as '0'

-n = Value at POR

'1' = Bit is set

'0' = Bit is cleared

x = Bit is unknown

bit 15-8 **Unimplemented:** Read as '0'

bit 7 **CVREN:** Comparator Voltage Reference Enable bit

1 = CVREF circuit powered on

0 = CVREF circuit powered down

bit 6 **CVROE:** Comparator VREF Output Enable bit

1 = CVREF voltage level is output on CVREF pin

0 = CVREF voltage level is disconnected from CVREF pin

bit 5 **CVRR:** Comparator VREF Range Selection bit

1 = CVRSRC range should be 0 to 0.625 CVRSRC with CVRSRC/24 step size

0 = CVRSRC range should be 0.25 to 0.719 CVRSRC with CVRSRC/32 step size

bit 4 **CVRSS:** Comparator VREF Source Selection bit

1 = Comparator reference source CVRSRC = VREF+ – VREF-

0 = Comparator reference source CVRSRC = AVDD – AVSS

bit 3-0 **CVR<3:0>:** Comparator VREF Value Selection $0 \leq \text{CVR}<3:0> \leq 15$ bits

When CVRR = 1:

$$CVREF = (\text{CVR}<3:0>/24) \cdot (CVRSRC)$$

When CVRR = 0:

$$CVREF = 1/4 \cdot (CVRSRC) + (\text{CVR}<3:0>/32) \cdot (CVRSRC)$$

22.0 REAL-TIME CLOCK AND CALENDAR (RTCC)

Note 1: This data sheet summarizes the features of the PIC24HJ32GP302/304, PIC24HJ64GPX02/X04 and PIC24HJ128GPX02/X04 families of devices. It is not intended to be a comprehensive reference source. To complement the information in this data sheet, refer to **Section 37. “Real-Time Clock and Calendar (RTCC)”** (DS70301) of the “*dsPIC33F/PIC24H Family Reference Manual*”, which is available from the Microchip web site (www.microchip.com).

2: Some registers and associated bits described in this section may not be available on all devices. Refer to **Section 4.0 “Memory Organization”** in this data sheet for device-specific register and bit information.

This chapter discusses the Real-Time Clock and Calendar (RTCC) module, available on PIC24HJ32GP302/304, PIC24HJ64GPX02/X04 and PIC24HJ128GPX02/X04 devices, and its operation.

Some of the key features of this module are:

- Time: hours, minutes and seconds
- 24-hour format (military time)
- Calendar: weekday, date, month and year
- Alarm configurable
- Year range: 2000 to 2099
- Leap year correction
- BCD format for compact firmware
- Optimized for low-power operation
- User calibration with auto-adjust
- Calibration range: ± 2.64 seconds error per month
- Requirements: External 32.768 kHz clock crystal
- Alarm pulse or seconds clock output on RTCC pin

The RTCC module is intended for applications where accurate time must be maintained for extended periods of time with minimum to no intervention from the CPU. The RTCC module is optimized for low-power usage to provide extended battery lifetime while keeping track of time.

The RTCC module is a 100-year clock and calendar with automatic leap year detection. The range of the clock is from 00:00:00 (midnight) on January 1, 2000 to 23:59:59 on December 31, 2099.

The hours are available in 24-hour (military time) format. The clock provides a granularity of one second with half-second visibility to the user.

FIGURE 22-1: RTCC BLOCK DIAGRAM



22.1 RTCC Module Registers

The RTCC module registers are organized into three categories:

- RTCC Control Registers
- RTCC Value Registers
- Alarm Value Registers

22.1.1 REGISTER MAPPING

To limit the register interface, the RTCC Timer and Alarm Time registers are accessed through corresponding register pointers. The RTCC Value register window (RTCVALH and RTCVALL) uses the RTCPTR bits (RCFGCAL<9:8>) to select the desired timer register pair (see [Table 22-1](#)).

By writing the RTCVALH byte, the RTCC Pointer value, RTCPTR<1:0> bits, decrement by one until they reach '00'. Once they reach '00', the MINUTES and SECONDS value will be accessible through RTCVALH and RTCVALL until the pointer value is manually changed.

TABLE 22-1: RTCVAL REGISTER MAPPING

RTCPTR <1:0>	RTCC Value Register Window	
	RTCVAL<15:8>	RTCVAL<7:0>
00	MINUTES	SECONDS
01	WEEKDAY	HOURS
10	MONTH	DAY
11	—	YEAR

The Alarm Value register window (ALRMVALH and ALRMVALL) uses the ALRMPTR bits (ALCFGRPT<9:8>) to select the desired Alarm register pair (see [Table 22-2](#)).

By writing the ALRMVALH byte, the Alarm Pointer value, ALRMPTR<1:0> bits, decrement by one until they reach '00'. Once they reach '00', the ALRMMIN and ALRMSEC value will be accessible through ALRMVALH and ALRMVALL until the pointer value is manually changed.

TABLE 22-2: ALRMVAL REGISTER MAPPING

ALRMPTR <1:0>	Alarm Value Register Window	
	ALRMVAL<15:8>	ALRMVAL<7:0>
00	ALRMMIN	ALRMSEC
01	ALRMWD	ALRMHR
10	ALRMMNTH	ALRMDAY
11	—	—

Considering that the 16-bit core does not distinguish between 8-bit and 16-bit read operations, the user must be aware that when reading either the ALRMVALH or ALRMVALL bytes will decrement the ALRMPTR<1:0> value. The same applies to the RTCVALH or RTCVALL bytes with the RTCPTR<1:0> being decremented.

Note: This only applies to read operations and not write operations.

22.1.2 WRITE LOCK

In order to perform a write to any of the RTCC Timer registers, the RTCWREN bit (RCFGCAL<13>) must be set (refer to [Example 22-1](#)).

Note: To avoid accidental writes to the timer, it is recommended that the RTCWREN bit (RCFGCAL<13>) is kept clear at any other time. For the RTCWREN bit to be set, there is only 1 instruction cycle time window allowed between the 55h/AA sequence and the setting of RTCWREN; therefore, it is recommended that code follow the procedure in [Example 22-1](#).

EXAMPLE 22-1: SETTING THE RTCWREN BIT

```

MOV    #NVMKEY, W1      ;move the address of NVMKEY into W1
MOV    #0x55, W2
MOV    #0xAA, W3
MOV    W2, [W1]         ;start 55/AA sequence
MOV    W3, [W1]
BSET   RCFGCAL, #13     ;set the RTCWREN bit
    
```

22.2 RTCC Resources

Many useful resources related to RTCC are provided on the main product page of the Microchip web site for the devices listed in this data sheet. This product page, which can be accessed using this [link](#), contains the latest updates and additional information.

Note: In the event you are not able to access the product page using the link above, enter this URL in your browser:
<http://www.microchip.com/wwwproducts/Devices.aspx?dDocName=en534555>

22.2.1 KEY RESOURCES

- **Section 37. “Real-Time Clock and Calendar (RTCC)” (DS70301)**
- Code Samples
- Application Notes
- Software Libraries
- Webinars
- All related dsPIC33F/PIC24H Family Reference Manuals Sections
- Development Tools

22.3 RTCC Registers

REGISTER 22-1: RCFGAL: RTCC CALIBRATION AND CONFIGURATION REGISTER⁽¹⁾

R/W-0	U-0	R/W-0	R-0	R-0	R/W-0	R/W-0	R/W-0
RTCEN ⁽²⁾	—	RTCWREN	RTCSYNC	HALFSEC ⁽³⁾	RTCOE	RTCPTR<1:0>	
bit 15						bit 8	

R/W-0	R/W-0	R/W-0	R/W-0	R/W-0	R/W-0	R/W-0	R/W-0
CAL<7:0>							
bit 7						bit 0	

Legend:			
R = Readable bit	W = Writable bit	U = Unimplemented bit, read as '0'	
-n = Value at POR	'1' = Bit is set	'0' = Bit is cleared	x = Bit is unknown

- bit 15 **RTCEN:** RTCC Enable bit⁽²⁾
 1 = RTCC module is enabled
 0 = RTCC module is disabled
- bit 14 **Unimplemented:** Read as '0'
- bit 13 **RTCWREN:** RTCC Value Registers Write Enable bit
 1 = RTCVALH and RTCVALL registers can be written to by the user
 0 = RTCVALH and RTCVALL registers are locked out from being written to by the user
- bit 12 **RTCSYNC:** RTCC Value Registers Read Synchronization bit
 1 = RTCVALH, RTCVALL and ALCFGRPT registers can change while reading due to a rollover ripple resulting in an invalid data read. If the register is read twice and results in the same data, the data can be assumed to be valid
 0 = RTCVALH, RTCVALL or ALCFGRPT registers can be read without concern over a rollover ripple
- bit 11 **HALFSEC:** Half-Second Status bit⁽³⁾
 1 = Second half period of a second
 0 = First half period of a second
- bit 10 **RTCOE:** RTCC Output Enable bit
 1 = RTCC output enabled
 0 = RTCC output disabled
- bit 9-8 **RTCPTR<1:0>:** RTCC Value Register Window Pointer bits
 Points to the corresponding RTCC Value registers when reading RTCVALH and RTCVALL registers; the RTCPTR<1:0> value decrements on every read or write of RTCVALH until it reaches '00'.
RTCVAL<15:8>:
 11 = Reserved
 10 = MONTH
 01 = WEEKDAY
 00 = MINUTES
RTCVAL<7:0>:
 11 = YEAR
 10 = DAY
 01 = HOURS
 00 = SECONDS

- Note 1:** The RCFGAL register is only affected by a POR.
- Note 2:** A write to the RTCEN bit is only allowed when RTCWREN = 1.
- Note 3:** This bit is read-only. It is cleared to '0' on a write to the lower half of the MINSEC register.

REGISTER 22-1: RCFGAL: RTCC CALIBRATION AND CONFIGURATION REGISTER⁽¹⁾ (CONTINUED)

bit 7-0

CAL<7:0>: RTC Drift Calibration bits

11111111 = Minimum negative adjustment; subtracts 4 RTC clock pulses every one minute

•
•
•

10000000 = Maximum negative adjustment; subtracts 512 RTC clock pulses every one minute

01111111 = Maximum positive adjustment; adds 508 RTC clock pulses every one minute

•
•
•

00000001 = Minimum positive adjustment; adds 4 RTC clock pulses every one minute

00000000 = No adjustment

Note 1: The RCFGAL register is only affected by a POR.

2: A write to the RTCEN bit is only allowed when RTCWREN = 1.

3: This bit is read-only. It is cleared to '0' on a write to the lower half of the MINSEC register.

PIC24HJ32GP302/304, PIC24HJ64GPX02/X04 AND PIC24HJ128GPX02/X04

REGISTER 22-2: PADCFG1: PAD CONFIGURATION CONTROL REGISTER

U-0	U-0	U-0	U-0	U-0	U-0	U-0	U-0
—	—	—	—	—	—	—	—
bit 15							bit 8

U-0	U-0	U-0	U-0	U-0	U-0	R/W-0	R/W-0
—	—	—	—	—	—	RTSECSEL ⁽¹⁾	PMPTTL
bit 7							bit 0

Legend:

R = Readable bit W = Writable bit U = Unimplemented bit, read as '0'
 -n = Value at POR '1' = Bit is set '0' = Bit is cleared x = Bit is unknown

- bit 15-2 **Unimplemented:** Read as '0'
- bit 1 **RTSECSEL:** RTCC Seconds Clock Output Select bit⁽¹⁾
 1 = RTCC seconds clock is selected for the RTCC pin
 0 = RTCC alarm pulse is selected for the RTCC pin
- bit 0 **PMPTTL:** PMP Module TTL Input Buffer Select bit
 1 = PMP module uses TTL input buffers
 0 = PMP module uses Schmitt Trigger input buffers

Note 1: To enable the actual RTCC output, the RTCOE bit (RCFGCAL<10>) needs to be set.

REGISTER 22-3: ALCFGRPT: ALARM CONFIGURATION REGISTER

R/W-0	R/W-0	R/W-0	R/W-0	R/W-0	R/W-0	R/W-0	R/W-0
ALRMEN	CHIME	AMASK<3:0>				ALRMPTR<1:0>	
bit 15						bit 8	

R/W-0	R/W-0	R/W-0	R/W-0	R/W-0	R/W-0	R/W-0	R/W-0
ARPT<7:0>							
bit 7						bit 0	

Legend:			
R = Readable bit	W = Writable bit	U = Unimplemented bit, read as '0'	
-n = Value at POR	'1' = Bit is set	'0' = Bit is cleared	x = Bit is unknown

- bit 15 **ALRMEN:** Alarm Enable bit
 1 = Alarm is enabled (cleared automatically after an alarm event whenever ARPT<7:0> = 0x00 and CHIME = 0)
 0 = Alarm is disabled
- bit 14 **CHIME:** Chime Enable bit
 1 = Chime is enabled; ARPT<7:0> bits are allowed to roll over from 0x00 to 0xFF
 0 = Chime is disabled; ARPT<7:0> bits stop once they reach 0x00
- bit 13-10 **AMASK<3:0>:** Alarm Mask Configuration bits
 11xx = Reserved – do not use
 101x = Reserved – do not use
 1001 = Once a year (except when configured for February 29th, once every 4 years)
 1000 = Once a month
 0111 = Once a week
 0110 = Once a day
 0101 = Every hour
 0100 = Every 10 minutes
 0011 = Every minute
 0010 = Every 10 seconds
 0001 = Every second
 0000 = Every half second
- bit 9-8 **ALRMPTR<1:0>:** Alarm Value Register Window Pointer bits
 Points to the corresponding Alarm Value registers when reading ALRMVALH and ALRMVALL registers; the ALRMPTR<1:0> value decrements on every read or write of ALRMVALH until it reaches '00'.
ALRMVAL<15:8>:
 11 = Unimplemented
 10 = ALRMMNTH
 01 = ALRMWD
 00 = ALRMMIN
ALRMVAL<7:0>:
 11 = Unimplemented
 10 = ALRMDAY
 01 = ALRMHR
 00 = ALRMSEC
- bit 7-0 **ARPT<7:0>:** Alarm Repeat Counter Value bits
 11111111 = Alarm will repeat 255 more times
 •
 •
 •
 00000000 = Alarm will not repeat
 The counter decrements on any alarm event. The counter is prevented from rolling over from 0x00 to 0xFF unless CHIME = 1.

PIC24HJ32GP302/304, PIC24HJ64GPX02/X04 AND PIC24HJ128GPX02/X04

REGISTER 22-4: RTCVAL (WHEN RTCPTR<1:0> = 11): YEAR VALUE REGISTER⁽¹⁾

U-0	U-0	U-0	U-0	U-0	U-0	U-0	U-0
—	—	—	—	—	—	—	—
bit 15							bit 8

R/W-x	R/W-x	R/W-x	R/W-x	R/W-x	R/W-x	R/W-x	R/W-x
YRTEN<3:0>				YRONE<3:0>			
bit 7							bit 0

Legend:

R = Readable bit W = Writable bit U = Unimplemented bit, read as '0'
 -n = Value at POR '1' = Bit is set '0' = Bit is cleared x = Bit is unknown

- bit 15-8 **Unimplemented:** Read as '0'
- bit 7-4 **YRTEN<3:0>:** Binary Coded Decimal Value of Year's Tens Digit; contains a value from 0 to 9
- bit 3-0 **YRONE<3:0>:** Binary Coded Decimal Value of Year's Ones Digit; contains a value from 0 to 9

Note 1: A write to the YEAR register is only allowed when RTCWREN = 1.

REGISTER 22-5: RTCVAL (WHEN RTCPTR<1:0> = 10): MONTH AND DAY VALUE REGISTER⁽¹⁾

U-0	U-0	U-0	R-x	R-x	R-x	R-x	R-x
—	—	—	MHTEN0	MTHONE<3:0>			
bit 15							bit 8

U-0	U-0	R/W-x	R/W-x	R/W-x	R/W-x	R/W-x	R/W-x
—	—	DAYTEN<1:0>		DAYONE<3:0>			
bit 7							bit 0

Legend:

R = Readable bit W = Writable bit U = Unimplemented bit, read as '0'
 -n = Value at POR '1' = Bit is set '0' = Bit is cleared x = Bit is unknown

- bit 15-13 **Unimplemented:** Read as '0'
- bit 12 **MHTEN0:** Binary Coded Decimal Value of Month's Tens Digit; contains a value of 0 or 1
- bit 11-8 **MTHONE<3:0>:** Binary Coded Decimal Value of Month's Ones Digit; contains a value from 0 to 9
- bit 7-6 **Unimplemented:** Read as '0'
- bit 5-4 **DAYTEN<1:0>:** Binary Coded Decimal Value of Day's Tens Digit; contains a value from 0 to 3
- bit 3-0 **DAYONE<3:0>:** Binary Coded Decimal Value of Day's Ones Digit; contains a value from 0 to 9

Note 1: A write to this register is only allowed when RTCWREN = 1.

REGISTER 22-6: RTCVAL (WHEN RTCPTR<1:0> = 01): WKDYHR: WEEKDAY AND HOURS VALUE REGISTER⁽¹⁾

U-0	U-0	U-0	U-0	U-0	R/W-x	R/W-x	R/W-x
—	—	—	—	—	WDAY<2:0>		
bit 15					bit 8		

U-0	U-0	R/W-x	R/W-x	R/W-x	R/W-x	R/W-x	R/W-x
—	—	HRTEN<1:0>		HRONE<3:0>			
bit 7				bit 0			

Legend:
 R = Readable bit W = Writable bit U = Unimplemented bit, read as '0'
 -n = Value at POR '1' = Bit is set '0' = Bit is cleared x = Bit is unknown

- bit 15-11 **Unimplemented:** Read as '0'
- bit 10-8 **WDAY<2:0>:** Binary Coded Decimal Value of Weekday Digit; contains a value from 0 to 6
- bit 7-6 **Unimplemented:** Read as '0'
- bit 5-4 **HRTEN<1:0>:** Binary Coded Decimal Value of Hour's Tens Digit; contains a value from 0 to 2
- bit 3-0 **HRONE<3:0>:** Binary Coded Decimal Value of Hour's Ones Digit; contains a value from 0 to 9

Note 1: A write to this register is only allowed when RTCWREN = 1.

REGISTER 22-7: RTCVAL (WHEN RTCPTR<1:0> = 00): MINUTES AND SECONDS VALUE REGISTER

U-0	R/W-x	R/W-x	R/W-x	R/W-x	R/W-x	R/W-x	R/W-x
—	MINTEN<2:0>			MINONE<3:0>			
bit 15					bit 8		

U-0	R/W-x	R/W-x	R/W-x	R/W-x	R/W-x	R/W-x	R/W-x
—	SECTEN<2:0>			SECONE<3:0>			
bit 7				bit 0			

Legend:
 R = Readable bit W = Writable bit U = Unimplemented bit, read as '0'
 -n = Value at POR '1' = Bit is set '0' = Bit is cleared x = Bit is unknown

- bit 15 **Unimplemented:** Read as '0'
- bit 14-12 **MINTEN<2:0>:** Binary Coded Decimal Value of Minute's Tens Digit; contains a value from 0 to 5
- bit 11-8 **MINONE<3:0>:** Binary Coded Decimal Value of Minute's Ones Digit; contains a value from 0 to 9
- bit 7 **Unimplemented:** Read as '0'
- bit 6-4 **SECTEN<2:0>:** Binary Coded Decimal Value of Second's Tens Digit; contains a value from 0 to 5
- bit 3-0 **SECONE<3:0>:** Binary Coded Decimal Value of Second's Ones Digit; contains a value from 0 to 9

PIC24HJ32GP302/304, PIC24HJ64GPX02/X04 AND PIC24HJ128GPX02/X04

REGISTER 22-8: ALRMVAL (WHEN ALRMPTR<1:0> = 10): ALARM MONTH AND DAY VALUE REGISTER⁽¹⁾

U-0	U-0	U-0	R/W-x	R/W-x	R/W-x	R/W-x	R/W-x	
—	—	—	MHTTEN0	MTHONE<3:0>				
bit 15								bit 8

U-0	U-0	R/W-x	R/W-x	R/W-x	R/W-x	R/W-x	R/W-x
—	—	DAYTEN<1:0>		DAYONE<3:0>			
bit 7						bit 0	

Legend:

R = Readable bit W = Writable bit U = Unimplemented bit, read as '0'
 -n = Value at POR '1' = Bit is set '0' = Bit is cleared x = Bit is unknown

- bit 15-13 **Unimplemented:** Read as '0'
- bit 12 **MHTTEN0:** Binary Coded Decimal Value of Month's Tens Digit; contains a value of 0 or 1
- bit 11-8 **MTHONE<3:0>:** Binary Coded Decimal Value of Month's Ones Digit; contains a value from 0 to 9
- bit 7-6 **Unimplemented:** Read as '0'
- bit 5-4 **DAYTEN<1:0>:** Binary Coded Decimal Value of Day's Tens Digit; contains a value from 0 to 3
- bit 3-0 **DAYONE<3:0>:** Binary Coded Decimal Value of Day's Ones Digit; contains a value from 0 to 9

Note 1: A write to this register is only allowed when RTCWREN = 1.

REGISTER 22-9: ALRMVAL (WHEN ALRMPTR<1:0> = 01): ALARM WEEKDAY AND HOURS VALUE REGISTER⁽¹⁾

U-0	U-0	U-0	U-0	U-0	R/W-x	R/W-x	R/W-x
—	—	—	—	—	WDAY2	WDAY1	WDAY0
bit 15							bit 8

U-0	U-0	R/W-x	R/W-x	R/W-x	R/W-x	R/W-x	R/W-x
—	—	HRTEN<1:0>		HRONE<3:0>			
bit 7						bit 0	

Legend:

R = Readable bit W = Writable bit U = Unimplemented bit, read as '0'
 -n = Value at POR '1' = Bit is set '0' = Bit is cleared x = Bit is unknown

- bit 15-11 **Unimplemented:** Read as '0'
- bit 10-8 **WDAY<2:0>:** Binary Coded Decimal Value of Weekday Digit; contains a value from 0 to 6
- bit 7-6 **Unimplemented:** Read as '0'
- bit 5-4 **HRTEN<1:0>:** Binary Coded Decimal Value of Hour's Tens Digit; contains a value from 0 to 2
- bit 3-0 **HRONE<3:0>:** Binary Coded Decimal Value of Hour's Ones Digit; contains a value from 0 to 9

Note 1: A write to this register is only allowed when RTCWREN = 1.

REGISTER 22-10: ALRMVAL (WHEN ALRMPTR<1:0> = 00): ALARM MINUTES AND SECONDS VALUE REGISTER

U-0	R/W-x	R/W-x	R/W-x	R/W-x	R/W-x	R/W-x	R/W-x
—	MINTEN<2:0>			MINONE<3:0>			
bit 15							bit 8

U-0	R/W-x	R/W-x	R/W-x	R/W-x	R/W-x	R/W-x	R/W-x
—	SECTEN<2:0>			SECCONE<3:0>			
bit 7							bit 0

Legend:

R = Readable bit	W = Writable bit	U = Unimplemented bit, read as '0'
-n = Value at POR	'1' = Bit is set	'0' = Bit is cleared x = Bit is unknown

- bit 15 **Unimplemented:** Read as '0'
- bit 14-12 **MINTEN<2:0>:** Binary Coded Decimal Value of Minute's Tens Digit; contains a value from 0 to 5
- bit 11-8 **MINONE<3:0>:** Binary Coded Decimal Value of Minute's Ones Digit; contains a value from 0 to 9
- bit 7 **Unimplemented:** Read as '0'
- bit 6-4 **SECTEN<2:0>:** Binary Coded Decimal Value of Second's Tens Digit; contains a value from 0 to 5
- bit 3-0 **SECCONE<3:0>:** Binary Coded Decimal Value of Second's Ones Digit; contains a value from 0 to 9

NOTES:

23.0 PROGRAMMABLE CYCLIC REDUNDANCY CHECK (CRC) GENERATOR

Note 1: This data sheet summarizes the features of the PIC24HJ32GP302/304, PIC24HJ64GPX02/X04 and PIC24HJ128GPX02/X04 families of devices. It is not intended to be a comprehensive reference source. To complement the information in this data sheet, refer to **Section 36. “Programmable Cyclic Redundancy Check (CRC)”** (DS70298) of the “dsPIC33F/PIC24H Family Reference Manual”, which is available from the Microchip web site (www.microchip.com).

2: Some registers and associated bits described in this section may not be available on all devices. Refer to **Section 4.0 “Memory Organization”** in this data sheet for device-specific register and bit information.

The programmable CRC generator offers the following features:

- User-programmable polynomial CRC equation
- Interrupt output
- Data FIFO

23.1 Overview

The module implements a software configurable CRC generator. The terms of the polynomial and its length can be programmed using the CRCXOR bits (X<15:1>) and the CRCCON bits (PLEN<3:0>), respectively.

EQUATION 23-1: CRC EQUATION

$$x^{16} + x^{12} + x^5 + 1$$

To program this polynomial into the CRC generator, the CRC register bits should be set as shown in **Table 23-1**.

TABLE 23-1: EXAMPLE CRC SETUP

Bit Name	Bit Value
PLEN<3:0>	1111
X<15:1>	000100000010000

For the value of X<15:1>, the 12th bit and the 5th bit are set to ‘1’, as required by the CRC equation. The 0th bit required by the CRC equation is always XORed. For a 16-bit polynomial, the 16th bit is also always assumed to be XORed; therefore, the X<15:1> bits do not have the 0th bit or the 16th bit.

The topology of a standard CRC generator is shown in **Figure 23-2**.

FIGURE 23-1: CRC SHIFTER DETAILS



FIGURE 23-2: CRC GENERATOR RECONFIGURED FOR $x^{16} + x^{12} + x^5 + 1$



23.2 User Interface

23.2.1 DATA INTERFACE

To start serial shifting, a '1' must be written to the CRCGO bit.

The module incorporates a FIFO that is 8 deep when $PLEN (PLEN < 3:0 >) > 7$, and 16 deep, otherwise. The data for which the CRC is to be calculated must first be written into the FIFO. The smallest data element that can be written into the FIFO is one byte. For example, if $PLEN = 5$, then the size of the data is $PLEN + 1 = 6$. The data must be written as follows:

```
data[5:0] = crc_input[5:0]
data[7:6] = 'bxxx'
```

Once data is written into the CRCWDAT MSb (as defined by $PLEN$), the value of $VWORD (VWORD < 4:0 >)$ increments by one. The serial shifter starts shifting data into the CRC engine when $CRCGO = 1$ and $VWORD > 0$. When the MSb is shifted out, $VWORD$ decrements by one. The serial shifter continues shifting until the $VWORD$ reaches 0. Therefore, for a given value of $PLEN$, it will take $(PLEN + 1) * VWORD$ number of clock cycles to complete the CRC calculations.

When $VWORD$ reaches 8 (or 16), the $CRCFUL$ bit will be set. When $VWORD$ reaches 0, the $CRCMPT$ bit will be set.

To continually feed data into the CRC engine, the recommended mode of operation is to initially "prime" the FIFO with a sufficient number of words so no interrupt is generated before the next word can be written. Once that is done, start the CRC by setting the $CRCGO$ bit to '1'. From that point onward, the $VWORD < 4:0 >$ bits should be polled. If they read less than 8 or 16, another word can be written into the FIFO.

To empty words already written into a FIFO, the $CRCGO$ bit must be set to '1' and the CRC shifter allowed to run until the $CRCMPT$ bit is set.

Also, to get the correct CRC reading, it is necessary to wait for the $CRCMPT$ bit to go high before reading the $CRCWDAT$ register.

If a word is written when the $CRCFUL$ bit is set, the $VWORD$ Pointer will roll over to 0. The hardware will then behave like the FIFO is empty. However, the condition to generate an interrupt will not be met; therefore, no interrupt will be generated (See [Section 23.2.2 "Interrupt Operation"](#)).

At least one instruction cycle must pass after a write to $CRCWDAT$ before a read of the $VWORD$ bits is done.

23.2.2 INTERRUPT OPERATION

When the $VWORD < 4:0 >$ bits make a transition from a value of '1' to '0', an interrupt will be generated.

23.3 Operation in Power-Saving Modes

23.3.1 SLEEP MODE

If Sleep mode is entered while the module is operating, the module will be suspended in its current state until clock execution resumes.

23.3.2 IDLE MODE

To continue full module operation in Idle mode, the $CSIDL$ bit must be cleared prior to entry into the mode.

If $CSIDL = 1$, the module will behave the same way as it does in Sleep mode; pending interrupt events will be passed on, even though the module clocks are not available.

23.4 Programmable CRC Resources

Many useful resources related to Programmable CRC are provided on the main product page of the Microchip web site for the devices listed in this data sheet. This product page, which can be accessed using this [link](#), contains the latest updates and additional information.

Note: In the event you are not able to access the product page using the link above, enter this URL in your browser:
<http://www.microchip.com/wwwproducts/Devices.aspx?dDocName=en534555>

23.4.1 KEY RESOURCES

- **Section 36. “Programmable Cyclic Redundancy Check CRC)”** (DS70298)
- Code Samples
- Application Notes
- Software Libraries
- Webinars
- All related dsPIC33F/PIC24H Family Reference Manuals Sections
- Development Tools

23.5 Programmable CRC Registers

REGISTER 23-1: CRCCON: CRC CONTROL REGISTER

U-0	U-0	R/W-0	R-0	R-0	R-0	R-0	R-0
—	—	CSIDL	VWORD<4:0>				
bit 15							bit 8

R-0	R-1	U-0	R/W-0	R/W-0	R/W-0	R/W-0	R/W-0
CRCFUL	CRCMPT	—	CRCGO	PLEN<3:0>			
bit 7							bit 0

Legend:

R = Readable bit W = Writable bit U = Unimplemented bit, read as '0'
 -n = Value at POR '1' = Bit is set '0' = Bit is cleared x = Bit is unknown

- bit 15-14 **Unimplemented:** Read as '0'
- bit 13 **CSIDL:** CRC Stop in Idle Mode bit
 1 = Discontinue module operation when device enters Idle mode
 0 = Continue module operation in Idle mode
- bit 12-8 **VWORD<4:0>:** Pointer Value bits
 Indicates the number of valid words in the FIFO. Has a maximum value of 8 when PLEN<3:0> is greater than 7, or 16 when PLEN<3:0> is less than or equal to 7.
- bit 7 **CRCFUL:** FIFO Full bit
 1 = FIFO is full
 0 = FIFO is not full
- bit 6 **CRCMPT:** FIFO Empty Bit
 1 = FIFO is empty
 0 = FIFO is not empty
- bit 5 **Unimplemented:** Read as '0'
- bit 4 **CRCGO:** Start CRC bit
 1 = Start CRC serial shifter
 0 = Turn off CRC serial shifter after FIFO is empty
- bit 3-0 **PLEN<3:0>:** Polynomial Length bits
 Denotes the length of the polynomial to be generated minus 1.

REGISTER 23-2: CRCXOR: CRC XOR POLYNOMIAL REGISTER

R/W-0	R/W-0	R/W-0	R/W-0	R/W-0	R/W-0	R/W-0	R/W-0
X<15:8>							
bit 15							bit 8

R/W-0	R/W-0	R/W-0	R/W-0	R/W-0	R/W-0	R/W-0	U-0
X<7:1>							—
bit 7							bit 0

Legend:			
R = Readable bit	W = Writable bit	U = Unimplemented bit, read as '0'	
-n = Value at POR	'1' = Bit is set	'0' = Bit is cleared	x = Bit is unknown

bit 15-1 **X<15:1>**: XOR of Polynomial Term X^n Enable bits
bit 0 **Unimplemented**: Read as '0'

NOTES:

24.0 PARALLEL MASTER PORT (PMP)

Note 1: This data sheet summarizes the features of the PIC24HJ32GP302/304, PIC24HJ64GPX02/X04 and PIC24HJ128GPX02/X04 families of devices. It is not intended to be a comprehensive reference source. To complement the information in this data sheet, refer to **Section 35. "Parallel Master Port (PMP)"** (DS70299) of the "dsPIC33F/PIC24H Family Reference Manual", which is available from the Microchip web site (www.microchip.com).

2: Some registers and associated bits described in this section may not be available on all devices. Refer to **Section 4.0 "Memory Organization"** in this data sheet for device-specific register and bit information.

The Parallel Master Port (PMP) module is a parallel 8-bit I/O module, specifically designed to communicate with a wide variety of parallel devices, such as communication peripherals, LCDs, external memory

devices and microcontrollers. Because the interface to parallel peripherals varies significantly, the PMP is highly configurable.

Key features of the PMP module include:

- Fully Multiplexed Address/Data Mode
- Demultiplexed or Partially Multiplexed Address/Data Mode:
 - Up to 11 address lines with single Chip Select
 - Up to 12 address lines without Chip Select
- Single Chip Select Line
- Programmable Strobe Options:
 - Individual Read and Write Strobes or;
 - Read/Write Strobe with Enable Strobe
- Address Auto-Increment/Auto-Decrement
- Programmable Address/Data Multiplexing
- Programmable Polarity on Control Signals
- Legacy Parallel Slave Port Support
- Enhanced Parallel Slave Support:
 - Address Support
 - 4-Byte Deep Auto-Incrementing Buffer
- Programmable Wait States
- Selectable Input Voltage Levels

FIGURE 24-1: PMP MODULE OVERVIEW



24.1 PMP Resources

Many useful resources related to PMP are provided on the main product page of the Microchip web site for the devices listed in this data sheet. This product page, which can be accessed using this [link](#), contains the latest updates and additional information.

<p>Note: In the event you are not able to access the product page using the link above, enter this URL in your browser: http://www.microchip.com/wwwproducts/Devices.aspx?dDocName=en534555</p>
--

24.1.1 KEY RESOURCES

- **Section 35. “Parallel Master Port”** (DS70299)
- Code Samples
- Application Notes
- Software Libraries
- Webinars
- All related dsPIC33F/PIC24H Family Reference Manuals Sections
- Development Tools

24.2 PMP Control Registers

REGISTER 24-1: PMCON: PARALLEL PORT CONTROL REGISTER

R/W-0	U-0	R/W-0	R/W-0	R/W-0	R/W-0	R/W-0	R/W-0
PMPEN	—	PSIDL	ADMUX1	ADMUX0	PTBEEN	PTWREN	PTRDEN
bit 15						bit 8	

R/W-0	R/W-0	R/W-0 ⁽¹⁾	U-0	R/W-0 ⁽¹⁾	R/W-0	R/W-0	R/W-0
CSF1	CSF0	ALP	—	CS1P	BEP	WRSP	RDSP
bit 7						bit 0	

Legend:

R = Readable bit	W = Writable bit	U = Unimplemented bit, read as '0'
-n = Value at POR	'1' = Bit is set	'0' = Bit is cleared
		x = Bit is unknown

- bit 15 **PMPEN:** Parallel Master Port Enable bit
 1 = PMP enabled
 0 = PMP disabled, no off-chip access performed
- bit 14 **Unimplemented:** Read as '0'
- bit 13 **PSIDL:** Stop in Idle Mode bit
 1 = Discontinue module operation when device enters Idle mode
 0 = Continue module operation in Idle mode
- bit 12-11 **ADMUX1:ADMUX0:** Address/Data Multiplexing Selection bits⁽¹⁾
 11 = Reserved
 10 = All 16 bits of address are multiplexed on PMD<7:0> pins
 01 = Lower 8 bits of address are multiplexed on PMD<7:0> pins, upper 3 bits are multiplexed on PMA<10:8>
 00 = Address and data appear on separate pins
- bit 10 **PTBEEN:** Byte Enable Port Enable bit (16-bit Master mode)
 1 = PMBE port enabled
 0 = PMBE port disabled
- bit 9 **PTWREN:** Write Enable Strobe Port Enable bit
 1 = PMWR/PMENB port enabled
 0 = PMWR/PMENB port disabled
- bit 8 **PTRDEN:** Read/Write Strobe Port Enable bit
 1 = PMRD/PMWR port enabled
 0 = PMRD/PMWR port disabled
- bit 7-6 **CSF1:CSF0:** Chip Select Function bits
 11 = Reserved
 10 = PMCS1 functions as chip select
 0x = PMCS1 functions as address bit 14
- bit 5 **ALP:** Address Latch Polarity bit⁽¹⁾
 1 = Active-high (PMALL and PMALH)
 0 = Active-low (PMALL and PMALH)
- bit 4 **Unimplemented:** Read as '0'
- bit 3 **CS1P:** Chip Select 1 Polarity bit⁽¹⁾
 1 = Active-high (PMCS1/PMCS1)
 0 = Active-low (PMCS1/PMCS1)

Note 1: These bits have no effect when their corresponding pins are used as address lines.

REGISTER 24-1: PMCON: PARALLEL PORT CONTROL REGISTER (CONTINUED)

- bit 2 **BEP:** Byte Enable Polarity bit
1 = Byte enable active-high ($\overline{\text{PMBE}}$)
0 = Byte enable active-low (PMBE)
- bit 1 **WRSP:** Write Strobe Polarity bit
For Slave modes and Master mode 2 (PMMODE<9:8> = 00, 01, 10):
1 = Write strobe active-high ($\overline{\text{PMWR}}$)
0 = Write strobe active-low (PMWR)
For Master mode 1 (PMMODE<9:8> = 11):
1 = Enable strobe active-high ($\overline{\text{PMENB}}$)
0 = Enable strobe active-low (PMENB)
- bit 0 **RDSP:** Read Strobe Polarity bit
For Slave modes and Master mode 2 (PMMODE<9:8> = 00, 01, 10):
1 = Read strobe active-high ($\overline{\text{PMRD}}$)
0 = Read strobe active-low (PMRD)
For Master mode 1 (PMMODE<9:8> = 11):
1 = Read/write strobe active-high ($\overline{\text{PMRD/PMWR}}$)
0 = Read/write strobe active-low (PMRD/PMWR)

Note 1: These bits have no effect when their corresponding pins are used as address lines.

Register 24-2: PMMODE: PARALLEL PORT MODE REGISTER

R-0	R/W-0	R/W-0	R/W-0	R/W-0	R/W-0	R/W-0	R/W-0
BUSY	IRQM<1:0>	INCM<1:0>	MODE16	MODE<1:0>			
bit 15							bit 8
R/W-0	R/W-0	R/W-0	R/W-0	R/W-0	R/W-0	R/W-0	R/W-0
WAITB<1:0> ⁽¹⁾	WAITM<3:0>	WAITE<1:0> ⁽¹⁾					
bit 7							bit 0

Legend:			
R = Readable bit	W = Writable bit	U = Unimplemented bit, read as '0'	
-n = Value at POR	'1' = Bit is set	'0' = Bit is cleared	x = Bit is unknown

- bit 15 **BUSY:** Busy bit (Master mode only)
 - 1 = Port is busy (not useful when the processor stall is active)
 - 0 = Port is not busy

- bit 14-13 **IRQM<1:0>:** Interrupt Request Mode bits
 - 11 = Interrupt generated when Read Buffer 3 is read or Write Buffer 3 is written (Buffered PSP mode) or on a read or write operation when PMA<1:0> = 11 (Addressable PSP mode only)
 - 10 = No interrupt generated, processor stall activated
 - 01 = Interrupt generated at the end of the read/write cycle
 - 00 = No interrupt generated

- bit 12-11 **INCM<1:0>:** Increment Mode bits
 - 11 = PSP read and write buffers auto-increment (Legacy PSP mode only)
 - 10 = Decrement ADDR<10:0> by 1 every read/write cycle
 - 01 = Increment ADDR<10:0> by 1 every read/write cycle
 - 00 = No increment or decrement of address

- bit 10 **MODE16:** 8/16-bit Mode bit
 - 1 = 16-bit mode: data register is 16 bits, a read or write to the data register invokes two 8-bit transfers
 - 0 = 8-bit mode: data register is 8 bits, a read or write to the data register invokes one 8-bit transfer

- bit 9-8 **MODE<1:0>:** Parallel Port Mode Select bits
 - 11 =Master mode 1 (PMCS1, PMRD/PMWR, PMENB, PMBE, PMA<x:0> and PMD<7:0>)
 - 10 =Master mode 2 (PMCS1, PMRD, PMWR, PMBE, PMA<x:0> and PMD<7:0>)
 - 01 =Enhanced PSP, control signals (PMRD, PMWR, PMCS1, PMD<7:0> and PMA<1:0>)
 - 00 =Legacy Parallel Slave Port, control signals (PMRD, PMWR, PMCS1 and PMD<7:0>)

- bit 7-6 **WAITB<1:0>:** Data Setup to Read/Write Wait State Configuration bits⁽¹⁾
 - 11 = Data wait of 4 Tcy; multiplexed address phase of 4 Tcy
 - 10 = Data wait of 3 Tcy; multiplexed address phase of 3 Tcy
 - 01 = Data wait of 2 Tcy; multiplexed address phase of 2 Tcy
 - 00 = Data wait of 1 Tcy; multiplexed address phase of 1 Tcy

- bit 5-2 **WAITM<3:0>:** Read to Byte Enable Strobe Wait State Configuration bits
 - 1111 = Wait of additional 15 Tcy
 -
 -
 -
 - 0001 = Wait of additional 1 Tcy
 - 0000 = No additional wait cycles (operation forced into one Tcy)

- bit 1-0 **WAITE<1:0>:** Data Hold After Strobe Wait State Configuration bits⁽¹⁾
 - 11 = Wait of 4 Tcy
 - 10 = Wait of 3 Tcy
 - 01 = Wait of 2 Tcy
 - 00 = Wait of 1 Tcy

Note 1: WAITB and WAITE bits are ignored whenever WAITM3:WAITM0 = 0000.

PIC24HJ32GP302/304, PIC24HJ64GPX02/X04 AND PIC24HJ128GPX02/X04

REGISTER 24-3: PMADDR: PARALLEL PORT ADDRESS REGISTER

R/W-0	R/W-0	R/W-0	R/W-0	R/W-0	R/W-0	R/W-0	R/W-0
ADDR15	CS1	ADDR<13:8>					
bit 15							bit 8

R/W-0	R/W-0	R/W-0	R/W-0	R/W-0	R/W-0	R/W-0	R/W-0
ADDR<7:0>							
bit 7							bit 0

Legend:

R = Readable bit W = Writable bit U = Unimplemented bit, read as '0'
 -n = Value at POR '1' = Bit is set '0' = Bit is cleared x = Bit is unknown

bit 15 **ADDR15:** Parallel Port Destination Address bits
 bit 14 **CS1:** Chip Select 1 bit
 1 = Chip select 1 is active
 0 = Chip select 1 is inactive
 bit 13-0 **ADDR13:ADDR0:** Parallel Port Destination Address bits

REGISTER 24-4: PMAEN: PARALLEL PORT ENABLE REGISTER

U-0	R/W-0	U-0	U-0	U-0	R/W-0	R/W-0	R/W-0
—	PTEN14	—	—	—	PTEN<10:8> ⁽¹⁾		
bit 15							bit 8

R/W-0	R/W-0	R/W-0	R/W-0	R/W-0	R/W-0	R/W-0	R/W-0
PTEN<7:2> ⁽¹⁾					PTEN<1:0>		
bit 7							bit 0

Legend:

R = Readable bit W = Writable bit U = Unimplemented bit, read as '0'
 -n = Value at POR '1' = Bit is set '0' = Bit is cleared x = Bit is unknown

bit 15 **Unimplemented:** Read as '0'
 bit 14 **PTEN14:** PMCS1 Strobe Enable bit
 1 = PMA14 functions as either PMA<14> bit or PMCS1
 0 = PMA14 pin functions as port I/O
 bit 13-11 **Unimplemented:** Read as '0'
 bit 10-2 **PTEN<10:2>:** PMP Address Port Enable bits⁽¹⁾
 1 = PMA<10:2> function as PMP address lines
 0 = PMA<10:2> function as port I/O
 bit 1-0 **PTEN<1:0>:** PMALH/PMALL Strobe Enable bits
 1 = PMA1 and PMA0 function as either PMA<1:0> or PMALH and PMALL
 0 = PMA1 and PMA0 pads functions as port I/O

Note 1: Devices with 28 pins do not have PMA<10:2>.

REGISTER 24-5: PMSTAT: PARALLEL PORT STATUS REGISTER

R-0	R/W-0, HS	U-0	U-0	R-0	R-0	R-0	R-0
IBF	IBOV	—	—	IB3F	IB2F	IB1F	IB0F
bit 15							bit 8

R-1	R/W-0, HS	U-0	U-0	R-1	R-1	R-1	R-1
OBE	OBUF	—	—	OB3E	OB2E	OB1E	OB0E
bit 7							bit 0

Legend:	HS = Hardware Set bit
R = Readable bit	W = Writable bit
-n = Value at POR	'1' = Bit is set
	U = Unimplemented bit, read as '0'
	'0' = Bit is cleared
	x = Bit is unknown

- bit 15 **IBF:** Input Buffer Full Status bit
 1 = All writable input buffer registers are full
 0 = Some or all of the writable input buffer registers are empty

- bit 14 **IBOV:** Input Buffer Overflow Status bit
 1 = A write attempt to a full input byte register occurred (must be cleared in software)
 0 = No overflow occurred

- bit 13-12 **Unimplemented:** Read as '0'

- bit 11-8 **IB3F:IB0F** Input Buffer x Status Full bits
 1 = Input buffer contains data that has not been read (reading buffer will clear this bit)
 0 = Input buffer does not contain any unread data

- bit 7 **OBE:** Output Buffer Empty Status bit
 1 = All readable output buffer registers are empty
 0 = Some or all of the readable output buffer registers are full

- bit 6 **OBUF:** Output Buffer Underflow Status bits
 1 = A read occurred from an empty output byte register (must be cleared in software)
 0 = No underflow occurred

- bit 5-4 **Unimplemented:** Read as '0'

- bit 3-0 **OB3E:OB0E** Output Buffer x Status Empty bit
 1 = Output buffer is empty (writing data to the buffer will clear this bit)
 0 = Output buffer contains data that has not been transmitted

PIC24HJ32GP302/304, PIC24HJ64GPX02/X04 AND PIC24HJ128GPX02/X04

REGISTER 24-6: PADCFG1: PAD CONFIGURATION CONTROL REGISTER

U-0	U-0	U-0	U-0	U-0	U-0	U-0	U-0
—	—	—	—	—	—	—	—
bit 15							bit 8

U-0	U-0	U-0	U-0	U-0	U-0	R/W-0	R/W-0
—	—	—	—	—	—	RTSECSEL ⁽¹⁾	PMPTTL
bit 7							bit 0

Legend:

R = Readable bit

W = Writable bit

U = Unimplemented bit, read as '0'

-n = Value at POR

'1' = Bit is set

'0' = Bit is cleared

x = Bit is unknown

bit 15-2 **Unimplemented:** Read as '0'

bit 1 **RTSECSEL:** RTCC Seconds Clock Output Select bit⁽¹⁾

1 = RTCC seconds clock is selected for the RTCC pin

0 = RTCC alarm pulse is selected for the RTCC pin

bit 0 **PMPTTL:** PMP Module TTL Input Buffer Select bit

1 = PMP module uses TTL input buffers

0 = PMP module uses Schmitt Trigger input buffers

Note 1: To enable the actual RTCC output, the RTCOE bit (RCFGCAL<10>) needs to be set.

25.0 SPECIAL FEATURES

Note 1: This data sheet summarizes the features of the PIC24HJ32GP302/304, PIC24HJ64GPX02/X04 and PIC24HJ128GPX02/X04 families of devices. It is not intended to be a comprehensive reference source. To complement the information in this data sheet, refer to the “dsPIC33F/PIC24H Family Reference Manual”. Please see the Microchip web site (www.microchip.com) for the latest dsPIC33F/PIC24H Family Reference Manual sections.

2: Some registers and associated bits described in this section may not be available on all devices. Refer to [Section 4.0 “Memory Organization”](#) in this data sheet for device-specific register and bit information.

The PIC24HJ32GP302/304, PIC24HJ64GPX02/X04 and PIC24HJ128GPX02/X04 devices include the following features that are intended to maximize application flexibility and reliability, and minimize cost through elimination of external components:

- Flexible configuration
- Watchdog Timer (WDT)
- Code Protection and CodeGuard™ Security
- JTAG Boundary Scan Interface
- In-Circuit Serial Programming™ (ICSP™)
- In-Circuit Emulation

25.1 Configuration Bits

The PIC24HJ32GP302/304, PIC24HJ64GPX02/X04 and PIC24HJ128GPX02/X04 devices provide nonvolatile memory implementation for device configuration bits. Refer to [Section 25. “Device Configuration”](#) (DS70194), in the “dsPIC33F/PIC24H Family Reference Manual” for more information on this implementation.

The Configuration bits can be programmed (read as ‘0’), or left unprogrammed (read as ‘1’), to select various device configurations. These bits are mapped starting at program memory location 0xF80000.

The individual Configuration bit descriptions for the Configuration registers are shown in [Table 25-1](#).

Note that address 0xF80000 is beyond the user program memory space. It belongs to the configuration memory space (0x800000-0xFFFFF), which can only be accessed using table reads and table writes.

The Device Configuration register map is shown in [Table 25-1](#).

TABLE 25-1: DEVICE CONFIGURATION REGISTER MAP

Address	Name	Bit 7	Bit 6	Bit 5	Bit 4	Bit 3	Bit 2	Bit 1	Bit 0
0xF80000	FBS	RBS<1:0>		—	—	BSS<2:0>		BWRP	
0xF80002	FSS ⁽¹⁾	RSS<1:0>		—	—	SSS<2:0>		SWRP	
0xF80004	FGS	—	—	—	—	—	GSS<1:0>		GWRP
0xF80006	FOSCSEL	IESO	—	—	—		FNOSC<2:0>		
0xF80008	FOSC	FCKSM<1:0>		IOL1WAY	—	—	OSCI0FNC	POSCMD<1:0>	
0xF8000A	FWDT	FWDTEN	WINDIS	—	WDTPRE	WDTPOST<3:0>			
0xF8000C	FPOR	Reserved ⁽²⁾			ALTI2C	—	FPWRT<2:0>		
0xF8000E	FICD	Reserved ⁽³⁾		JTAGEN	—	—	—	ICS<1:0>	
0xF80010	FUID0	User Unit ID Byte 0							
0xF80012	FUID1	User Unit ID Byte 1							
0xF80014	FUID2	User Unit ID Byte 2							
0xF80016	FUID3	User Unit ID Byte 3							

Legend: — = unimplemented bit, read as ‘0’.

Note 1: This Configuration register is not available and reads as 0xFF on PIC24HJ32GP302/304 devices.

2: These bits are reserved and always read as ‘1’.

3: These bits are reserved for use by development tools and must be programmed as ‘1’.

TABLE 25-2: PIC24H CONFIGURATION BITS DESCRIPTION

Bit Field	Register	RTSP Effect	Description
BWRP	FBS	Immediate	Boot Segment Program Flash Write Protection 1 = Boot segment can be written 0 = Boot segment is write-protected
BSS<2:0>	FBS	Immediate	Boot Segment Program Flash Code Protection Size x11 = No Boot program Flash segment Boot space is 1K Instruction Words (except interrupt vectors) 110 = Standard security; boot program Flash segment ends at 0x0007FE 010 = High security; boot program Flash segment ends at 0x0007FE Boot space is 4K Instruction Words (except interrupt vectors) 101 = Standard security; boot program Flash segment, ends at 0x001FFE 001 = High security; boot program Flash segment ends at 0x001FFE Boot space is 8K Instruction Words (except interrupt vectors) 100 = Standard security; boot program Flash segment ends at 0x003FFE 000 = High security; boot program Flash segment ends at 0x003FFE
RBS<1:0> ⁽¹⁾	FBS	Immediate	Boot Segment RAM Code Protection Size 11 = No Boot RAM defined 10 = Boot RAM is 128 bytes 01 = Boot RAM is 256 bytes 00 = Boot RAM is 1024 bytes
SWRP ⁽¹⁾	FSS ⁽¹⁾	Immediate	Secure Segment Program Flash Write-Protect bit 1 = Secure Segment can bet written 0 = Secure Segment is write-protected
SSS<2:0> ⁽¹⁾	FSS ⁽¹⁾	Immediate	Secure Segment Program Flash Code Protection Size (Secure segment is not implemented on 32K devices) x11 = No Secure program flash segment Secure space is 4K IW less BS 110 = Standard security; secure program flash segment starts at End of BS, ends at 0x001FFE 010 = High security; secure program flash segment starts at End of BS, ends at 0x001FFE Secure space is 8K IW less BS 101 = Standard security; secure program flash segment starts at End of BS, ends at 0x003FFE 001 = High security; secure program flash segment starts at End of BS, ends at 0x003FFE Secure space is 16K IW less BS 100 = Standard security; secure program flash segment starts at End of BS, ends at 007FFEH 000 = High security; secure program flash segment starts at End of BS, ends at 0x007FFE

Note 1: This Configuration register is not available on PIC24HJ32GP302/304 devices.

TABLE 25-2: PIC24H CONFIGURATION BITS DESCRIPTION (CONTINUED)

Bit Field	Register	RTSP Effect	Description
RSS<1:0> ⁽¹⁾	FSS ⁽¹⁾	Immediate	Secure Segment RAM Code Protection 11 = No Secure RAM defined 10 = Secure RAM is 256 Bytes less BS RAM 01 = Secure RAM is 2048 Bytes less BS RAM 00 = Secure RAM is 4096 Bytes less BS RAM
GSS<1:0>	FGS	Immediate	General Segment Code-Protect bit 11 = User program memory is not code-protected 10 = Standard security 0x = High security
GWRP	FGS	Immediate	General Segment Write-Protect bit 1 = User program memory is not write-protected 0 = User program memory is write-protected
IESO	FOSCSEL	Immediate	Two-speed Oscillator Start-up Enable bit 1 = Start-up device with FRC, then automatically switch to the user-selected oscillator source when ready 0 = Start-up device with user-selected oscillator source
FNOSC<2:0>	FOSCSEL	If clock switch is enabled, RTSP effect is on any device Reset; otherwise, Immediate	Initial Oscillator Source Selection bits 111 = Internal Fast RC (FRC) oscillator with postscaler 110 = Internal Fast RC (FRC) oscillator with divide-by-16 101 = LPRC oscillator 100 = Secondary (LP) oscillator 011 = Primary (XT, HS, EC) oscillator with PLL 010 = Primary (XT, HS, EC) oscillator 001 = Internal Fast RC (FRC) oscillator with PLL 000 = FRC oscillator
FCKSM<1:0>	FOSC	Immediate	Clock Switching Mode bits 1x = Clock switching is disabled, Fail-Safe Clock Monitor is disabled 01 = Clock switching is enabled, Fail-Safe Clock Monitor is disabled 00 = Clock switching is enabled, Fail-Safe Clock Monitor is enabled
IOL1WAY	FOSC	Immediate	Peripheral pin select configuration 1 = Allow only one reconfiguration 0 = Allow multiple reconfigurations
OSCIOFNC	FOSC	Immediate	OSC2 Pin Function bit (except in XT and HS modes) 1 = OSC2 is clock output 0 = OSC2 is general purpose digital I/O pin
POSCMD<1:0>	FOSC	Immediate	Primary Oscillator Mode Select bits 11 = Primary oscillator disabled 10 = HS Crystal Oscillator mode 01 = XT Crystal Oscillator mode 00 = EC (External Clock) mode
FWDTEN	FWDT	Immediate	Watchdog Timer Enable bit 1 = Watchdog Timer always enabled (LPRC oscillator cannot be disabled. Clearing the SWDTEN bit in the RCON register has no effect.) 0 = Watchdog Timer enabled/disabled by user software (LPRC can be disabled by clearing the SWDTEN bit in the RCON register)
WINDIS	FWDT	Immediate	Watchdog Timer Window Enable bit 1 = Watchdog Timer in Non-Window mode 0 = Watchdog Timer in Window mode

Note 1: This Configuration register is not available on PIC24HJ32GP302/304 devices.

PIC24HJ32GP302/304, PIC24HJ64GPX02/X04 AND PIC24HJ128GPX02/X04

TABLE 25-2: PIC24H CONFIGURATION BITS DESCRIPTION (CONTINUED)

Bit Field	Register	RTSP Effect	Description
WDTPRE	FWDT	Immediate	Watchdog Timer Prescaler bit 1 = 1:128 0 = 1:32
WDTPOST<3:0>	FWDT	Immediate	Watchdog Timer Postscaler bits 1111 = 1:32,768 1110 = 1:16,384 • • • 0001 = 1:2 0000 = 1:1
FPWRT<2:0>	FPOR	Immediate	Power-on Reset Timer Value Select bits 111 = PWRT = 128 ms 110 = PWRT = 64 ms 101 = PWRT = 32 ms 100 = PWRT = 16 ms 011 = PWRT = 8 ms 010 = PWRT = 4 ms 001 = PWRT = 2 ms 000 = PWRT = Disabled
ALT2C	FPOR	Immediate	Alternate I ² C™ pins 1 = I ² C mapped to SDA1/SCL1 pins 0 = I ² C mapped to ASDA1/ASCL1 pins
JTAGEN	FICD	Immediate	JTAG Enable bit 1 = JTAG enabled 0 = JTAG disabled
ICS<1:0>	FICD	Immediate	ICD Communication Channel Select bits 11 = Communicate on PGEC1 and PGED1 10 = Communicate on PGEC2 and PGED2 01 = Communicate on PGEC3 and PGED3 00 = Reserved, do not use

Note 1: This Configuration register is not available on PIC24HJ32GP302/304 devices.

25.2 On-Chip Voltage Regulator

All of the PIC24HJ32GP302/304, PIC24HJ64GPX02/X04 and PIC24HJ128GPX02/X04 devices power their core digital logic at a nominal 2.5V. This can create a conflict for designs that are required to operate at a higher typical voltage, such as 3.3V. To simplify system design, all devices in the PIC24HJ32GP302/304, PIC24HJ64GPX02/X04 and PIC24HJ128GPX02/X04 family incorporate an on-chip regulator that allows the device to run its core logic from VDD.

The regulator provides power to the core from the other VDD pins. When the regulator is enabled, a low-ESR (less than 5 Ohms) capacitor (such as tantalum or ceramic) must be connected to the VCAP pin (Figure 25-1). This helps to maintain the stability of the regulator. The recommended value for the filter capacitor is provided in Table 28-13 located in Section 28.1 “DC Characteristics”.

Note: It is important for the low-ESR capacitor to be placed as close as possible to the VCAP pin.

On a POR, it takes approximately 20 μ s for the on-chip voltage regulator to generate an output voltage. During this time, designated as TSTARTUP, code execution is disabled. TSTARTUP is applied every time the device resumes operation after any power-down.

FIGURE 25-1: CONNECTIONS FOR THE ON-CHIP VOLTAGE REGULATOR^(1,2,3)



25.3 Brown-out Reset (BOR)

The Brown-out Reset (BOR) module is based on an internal voltage reference circuit that monitors the regulated supply voltage VCAP. The main purpose of the BOR module is to generate a device Reset when a brown-out condition occurs. Brown-out conditions are generally caused by glitches on the AC mains (for example, missing portions of the AC cycle waveform due to bad power transmission lines, or voltage sags due to excessive current draw when a large inductive load is turned on).

A BOR generates a Reset pulse, which resets the device. The BOR selects the clock source, based on the device Configuration bit values (FNOSC<2:0> and POSCMD<1:0>).

If an oscillator mode is selected, the BOR activates the Oscillator Start-up Timer (OST). The system clock is held until OST expires. If the PLL is used, the clock is held until the LOCK bit (OSCCON<5>) is ‘1’.

Concurrently, the PWRT time-out (TPWRT) is applied before the internal Reset is released. If TPWRT = 0 and a crystal oscillator is being used, then a nominal delay of TFSCM = 100 is applied. The total delay in this case is TFSCM.

The BOR Status bit (RCON<1>) is set to indicate that a BOR has occurred. The BOR circuit continues to operate while in Sleep or Idle modes and resets the device should VDD fall below the BOR threshold voltage.

25.4 Watchdog Timer (WDT)

For PIC24HJ32GP302/304, PIC24HJ64GPX02/X04 and PIC24HJ128GPX02/X04 devices, the WDT is driven by the LPRC oscillator. When the WDT is enabled, the clock source is also enabled.

25.4.1 PRESCALER/POSTSCALER

The nominal WDT clock source from LPRC is 32 kHz. This feeds a prescaler that can be configured for either 5-bit (divide-by-32) or 7-bit (divide-by-128) operation. The prescaler is set by the WDTPRE Configuration bit. With a 32 kHz input, the prescaler yields a nominal WDT time-out period (TWDT) of 1 ms in 5-bit mode, or 4 ms in 7-bit mode.

A variable postscaler divides down the WDT prescaler output and allows for a wide range of time-out periods. The postscaler is controlled by the WDTPOST<3:0> Configuration bits (FWDT<3:0>), which allow the selection of 16 settings, from 1:1 to 1:32,768. Using the prescaler and postscaler, time-out periods ranging from 1 ms to 131 seconds can be achieved.

The WDT, prescaler and postscaler are reset:

- On any device Reset
- On the completion of a clock switch, whether invoked by software (i.e., setting the OSWEN bit after changing the NOSC bits) or by hardware (i.e., Fail-Safe Clock Monitor)
- When a PWRSAV instruction is executed (i.e., Sleep or Idle mode is entered)
- When the device exits Sleep or Idle mode to resume normal operation
- By a CLRWDT instruction during normal execution

Note: The CLRWDT and PWRSAV instructions clear the prescaler and postscaler counts when executed.

25.4.2 SLEEP AND IDLE MODES

If the WDT is enabled, it continues to run during Sleep or Idle modes. When the WDT time-out occurs, the device wakes the device and code execution continues from where the PWRSAV instruction was executed. The corresponding SLEEP or IDLE bits (RCON<3,2>) needs to be cleared in software after the device wakes up.

25.4.3 ENABLING WDT

The WDT is enabled or disabled by the FWDTEN Configuration bit in the FWDT Configuration register. When the FWDTEN Configuration bit is set, the WDT is always enabled.

The WDT can be optionally controlled in software when the FWDTEN Configuration bit has been programmed to '0'. The WDT is enabled in software by setting the SWDTEN control bit (RCON<5>). The SWDTEN control bit is cleared on any device Reset. The software WDT option allows the user application to enable the WDT for critical code segments and disable the WDT during non-critical segments for maximum power savings.

Note: If the WINDIS bit (FWDT<6>) is cleared, the CLRWDT instruction should be executed by the application software only during the last 1/4 of the WDT period. This CLRWDT window can be determined by using a timer. If a CLRWDT instruction is executed before this window, a WDT Reset occurs.

The WDT flag bit, WDTO (RCON<4>), is not automatically cleared following a WDT time-out. To detect subsequent WDT events, the flag must be cleared in software.

FIGURE 25-2: WDT BLOCK DIAGRAM



25.5 JTAG Interface

The PIC24HJ32GP302/304, PIC24HJ64GPX02/X04 and PIC24HJ128GPX02/X04 devices implement a JTAG interface, which supports boundary scan device testing, as well as in-circuit programming. Detailed information on this interface is provided in future revisions of the document.

Note: Refer to **Section 24. “Programming and Diagnostics”** (DS70246) of the *“dsPIC33F/PIC24H Family Reference Manual”* for further information on usage, configuration and operation of the JTAG interface.

25.6 In-Circuit Serial Programming

The PIC24HJ32GP302/304, PIC24HJ64GPX02/X04 and PIC24HJ128GPX02/X04 devices can be serially programmed while in the end application circuit. This is done with two lines for clock and data and three other lines for power, ground and the programming sequence. Serial programming allows customers to manufacture boards with unprogrammed devices and then program the microcontroller just before shipping the product. Serial programming also allows the most recent firmware or a custom firmware to be programmed. Refer to the *“dsPIC33F/PIC24H Flash Programming Specification”* (DS70152) for details about In-Circuit Serial Programming (ICSP).

Any of the three pairs of programming clock/data pins can be used:

- PGEC1 and PGED1
- PGEC2 and PGED2
- PGEC3 and PGED3

25.7 In-Circuit Debugger

When MPLAB® ICD 2 is selected as a debugger, the in-circuit debugging functionality is enabled. This function allows simple debugging functions when used with MPLAB IDE. Debugging functionality is controlled through the PGECx (Emulation/Debug Clock) and PGEDx (Emulation/Debug Data) pin functions.

Any of the three pairs of debugging clock/data pins can be used:

- PGEC1 and PGED1
- PGEC2 and PGED2
- PGEC3 and PGED3

To use the in-circuit debugger function of the device, the design must implement ICSP connections to MCLR, VDD, VSS, and the PGECx/PGEDx pin pair. In addition, when the feature is enabled, some of the resources are not available for general use. These resources include the first 80 bytes of data RAM and two I/O pins.

25.8 Code Protection and CodeGuard™ Security

The PIC24HJ64GPX02/X04 and PIC24HJ128GPX02/X04 devices offer advanced implementation of CodeGuard Security that supports BS, SS and GS while, the PIC24HJ32GP302/304 devices offer the intermediate level of CodeGuard Security that supports only BS and GS. CodeGuard Security enables multiple parties to securely share resources (memory, interrupts and peripherals) on a single chip. This feature helps protect individual Intellectual Property in collaborative system designs.

When coupled with software encryption libraries, CodeGuard Security can be used to securely update Flash even when multiple IPs reside on the single chip. The code protection features vary depending on the actual PIC24H implemented. The following sections provide an overview of these features.

Secure segment and RAM protection is implemented on the PIC24HJ64GPX02/X04 and PIC24HJ128GPX02/X04 devices. The PIC24HJ32GP302/304 devices do not support secure segment and RAM protection.

Note: Refer to **Section 23. “CodeGuard™ Security”** (DS70239) of the *“dsPIC33F/PIC24H Family Reference Manual”* for further information on usage, configuration and operation of CodeGuard Security.

TABLE 25-3: CODE FLASH SECURITY SEGMENT SIZES FOR 32 KB DEVICES

CONFIG BITS	BSS<2:0> = x11 0K		BSS<2:0> = x10 1K		BSS<2:0> = x01 4K		BSS<2:0> = x00 8K	
SSS<2:0> = x11 0K	VS = 256 IW	0x000000h 0x0001FEh 0x000200h 0x0007FEh 0x000800h 0x001FFEh 0x002000h 0x003FFEh 0x004000h 0x0057FEh	VS = 256 IW	0x000000h 0x0001FEh 0x000200h 0x0007FEh 0x000800h 0x001FFEh 0x002000h 0x003FFEh 0x004000h 0x0057FEh	VS = 256 IW	0x000000h 0x0001FEh 0x000200h 0x0007FEh 0x000800h 0x001FFEh 0x002000h 0x003FFEh 0x004000h 0x0057FEh	VS = 256 IW	0x000000h 0x0001FEh 0x000200h 0x0007FEh 0x000800h 0x001FFEh 0x002000h 0x003FFEh 0x004000h 0x0057FEh
			BS = 768 IW		BS = 3840 IW		BS = 7936 IW	
		GS = 11008 IW		GS = 10240 IW		GS = 7168 IW		GS = 3072 IW
		0x0157FEh		0x0157FEh		0x0157FEh		0x0157FEh

TABLE 25-4: CODE FLASH SECURITY SEGMENT SIZES FOR 64 KB DEVICES

CONFIG BITS	BSS<2:0> = x11 0K		BSS<2:0> = x10 1K		BSS<2:0> = x01 4K		BSS<2:0> = x00 8K			
SSS<2:0> = x11 0K	VS = 256 IW	0x000000h 0x0001FEh 0x000200h 0x0007FEh 0x000800h 0x001FFEh 0x002000h 0x003FFEh 0x004000h 0x007FFEh 0x008000h 0x00ABFEh	VS = 256 IW	0x000000h 0x0001FEh 0x000200h 0x0007FEh 0x000800h 0x001FFEh 0x002000h 0x003FFEh 0x004000h 0x007FFEh 0x008000h 0x00ABFEh	VS = 256 IW	0x000000h 0x0001FEh 0x000200h 0x0007FEh 0x000800h 0x001FFEh 0x002000h 0x003FFEh 0x004000h 0x007FFEh 0x008000h 0x00ABFEh	VS = 256 IW	0x000000h 0x0001FEh 0x000200h 0x0007FEh 0x000800h 0x001FFEh 0x002000h 0x003FFEh 0x004000h 0x007FFEh 0x008000h 0x00ABFEh	VS = 256 IW	0x000000h 0x0001FEh 0x000200h 0x0007FEh 0x000800h 0x001FFEh 0x002000h 0x003FFEh 0x004000h 0x007FFEh 0x008000h 0x00ABFEh
			BS = 768 IW		BS = 3840 IW		BS = 7936 IW			
	GS = 21760 IW		GS = 20992 IW		GS = 17920 IW		GS = 13824 IW			
		0x0157FEh		0x0157FEh		0x0157FEh		0x0157FEh		0x0157FEh
SSS<2:0> = x10 4K	VS = 256 IW	0x000000h 0x0001FEh 0x000200h 0x0007FEh 0x000800h 0x001FFEh 0x002000h 0x003FFEh 0x004000h 0x007FFEh 0x008000h 0x00ABFEh	VS = 256 IW	0x000000h 0x0001FEh 0x000200h 0x0007FEh 0x000800h 0x001FFEh 0x002000h 0x003FFEh 0x004000h 0x007FFEh 0x008000h 0x00ABFEh	VS = 256 IW	0x000000h 0x0001FEh 0x000200h 0x0007FEh 0x000800h 0x001FFEh 0x002000h 0x003FFEh 0x004000h 0x007FFEh 0x008000h 0x00ABFEh	VS = 256 IW	0x000000h 0x0001FEh 0x000200h 0x0007FEh 0x000800h 0x001FFEh 0x002000h 0x003FFEh 0x004000h 0x007FFEh 0x008000h 0x00ABFEh	VS = 256 IW	0x000000h 0x0001FEh 0x000200h 0x0007FEh 0x000800h 0x001FFEh 0x002000h 0x003FFEh 0x004000h 0x007FFEh 0x008000h 0x00ABFEh
			BS = 768 IW	SS = 3072 IW	BS = 3840 IW		BS = 7936 IW			
	GS = 17920 IW		GS = 17920 IW		GS = 17920 IW		GS = 13824 IW			
		0x0157FEh		0x0157FEh		0x0157FEh		0x0157FEh		0x0157FEh
SSS<2:0> = x01 8K	VS = 256 IW	0x000000h 0x0001FEh 0x000200h 0x0007FEh 0x000800h 0x001FFEh 0x002000h 0x003FFEh 0x004000h 0x007FFEh 0x008000h 0x00ABFEh	VS = 256 IW	0x000000h 0x0001FEh 0x000200h 0x0007FEh 0x000800h 0x001FFEh 0x002000h 0x003FFEh 0x004000h 0x007FFEh 0x008000h 0x00ABFEh	VS = 256 IW	0x000000h 0x0001FEh 0x000200h 0x0007FEh 0x000800h 0x001FFEh 0x002000h 0x003FFEh 0x004000h 0x007FFEh 0x008000h 0x00ABFEh	VS = 256 IW	0x000000h 0x0001FEh 0x000200h 0x0007FEh 0x000800h 0x001FFEh 0x002000h 0x003FFEh 0x004000h 0x007FFEh 0x008000h 0x00ABFEh	VS = 256 IW	0x000000h 0x0001FEh 0x000200h 0x0007FEh 0x000800h 0x001FFEh 0x002000h 0x003FFEh 0x004000h 0x007FFEh 0x008000h 0x00ABFEh
			BS = 768 IW	SS = 7168 IW	BS = 3840 IW	SS = 4096 IW	BS = 7936 IW			
	GS = 13824 IW		GS = 13824 IW		GS = 13824 IW		GS = 13824 IW			
		0x0157FEh		0x0157FEh		0x0157FEh		0x0157FEh		0x0157FEh
SSS<2:0> = x00 16K	VS = 256 IW	0x000000h 0x0001FEh 0x000200h 0x0007FEh 0x000800h 0x001FFEh 0x002000h 0x003FFEh 0x004000h 0x007FFEh 0x008000h 0x00ABFEh	VS = 256 IW	0x000000h 0x0001FEh 0x000200h 0x0007FEh 0x000800h 0x001FFEh 0x002000h 0x003FFEh 0x004000h 0x007FFEh 0x008000h 0x00ABFEh	VS = 256 IW	0x000000h 0x0001FEh 0x000200h 0x0007FEh 0x000800h 0x001FFEh 0x002000h 0x003FFEh 0x004000h 0x007FFEh 0x008000h 0x00ABFEh	VS = 256 IW	0x000000h 0x0001FEh 0x000200h 0x0007FEh 0x000800h 0x001FFEh 0x002000h 0x003FFEh 0x004000h 0x007FFEh 0x008000h 0x00ABFEh	VS = 256 IW	0x000000h 0x0001FEh 0x000200h 0x0007FEh 0x000800h 0x001FFEh 0x002000h 0x003FFEh 0x004000h 0x007FFEh 0x008000h 0x00ABFEh
			BS = 768 IW	SS = 15360 IW	BS = 3840 IW	SS = 12288 IW	BS = 7936 IW			
	GS = 5632 IW		GS = 5632 IW		GS = 5632 IW		GS = 5632 IW			
		0x0157FEh		0x0157FEh		0x0157FEh		0x0157FEh		0x0157FEh

TABLE 25-5: CODE FLASH SECURITY SEGMENT SIZES FOR 128 KB DEVICES

CONFIG BITS	BSS<2:0> = x11 0K		BSS<2:0> = x10 1K		BSS<2:0> = x01 4K		BSS<2:0> = x00 8K	
SSS<2:0> = x11 0K	VS = 256 IW	0x000000h 0x0001FEh 0x000200h 0x0007FEh 0x000800h 0x001FFEh 0x002000h 0x003FFEh 0x004000h 0x007FFEh 0x008000h 0x00FFFEh 0x010000h	VS = 256 IW BS = 768 IW	0x000000h 0x0001FEh 0x000200h 0x0007FEh 0x000800h 0x001FFEh 0x002000h 0x003FFEh 0x004000h 0x007FFEh 0x008000h 0x00FFFEh 0x010000h	VS = 256 IW BS = 3840 IW	0x000000h 0x0001FEh 0x000200h 0x0007FEh 0x000800h 0x001FFEh 0x002000h 0x003FFEh 0x004000h 0x007FFEh 0x008000h 0x00FFFEh 0x010000h	VS = 256 IW BS = 7936 IW	0x000000h 0x0001FEh 0x000200h 0x0007FEh 0x000800h 0x001FFEh 0x002000h 0x003FFEh 0x004000h 0x007FFEh 0x008000h 0x00FFFEh 0x010000h
	GS = 43776 IW	0x0157FEh	GS = 43008 IW	0x0157FEh	GS = 39936 IW	0x0157FEh	GS = 35840 IW	0x0157FEh
SSS<2:0> = x10 4K	VS = 256 IW	0x000000h 0x0001FEh 0x000200h 0x0007FEh 0x000800h 0x001FFEh 0x002000h 0x003FFEh 0x004000h 0x007FFEh 0x008000h 0x00ABFEh	VS = 256 IW BS = 768 IW SS = 3072 IW	0x000000h 0x0001FEh 0x000200h 0x0007FEh 0x000800h 0x001FFEh 0x002000h 0x003FFEh 0x004000h 0x007FFEh 0x008000h 0x00ABFEh	VS = 256 IW BS = 3840 IW	0x000000h 0x0001FEh 0x000200h 0x0007FEh 0x000800h 0x001FFEh 0x002000h 0x003FFEh 0x004000h 0x007FFEh 0x008000h 0x00ABFEh	VS = 256 IW BS = 7936 IW	0x000000h 0x0001FEh 0x000200h 0x0007FEh 0x000800h 0x001FFEh 0x002000h 0x003FFEh 0x004000h 0x007FFEh 0x008000h 0x00ABFEh
	GS = 39936 IW	0x0157FEh	GS = 39936 IW	0x0157FEh	GS = 39936 IW	0x0157FEh	GS = 35840 IW	0x0157FEh
SSS<2:0> = x01 8K	VS = 256 IW	0x000000h 0x0001FEh 0x000200h 0x0007FEh 0x000800h 0x001FFEh 0x002000h 0x003FFEh 0x004000h 0x007FFEh 0x008000h 0x00FFFEh 0x010000h	VS = 256 IW BS = 768 IW SS = 7168 IW	0x000000h 0x0001FEh 0x000200h 0x0007FEh 0x000800h 0x001FFEh 0x002000h 0x003FFEh 0x004000h 0x007FFEh 0x008000h 0x00FFFEh 0x010000h	VS = 256 IW BS = 3840 IW SS = 4096 IW	0x000000h 0x0001FEh 0x000200h 0x0007FEh 0x000800h 0x001FFEh 0x002000h 0x003FFEh 0x004000h 0x007FFEh 0x008000h 0x00FFFEh 0x010000h	VS = 256 IW BS = 7936 IW	0x000000h 0x0001FEh 0x000200h 0x0007FEh 0x000800h 0x001FFEh 0x002000h 0x003FFEh 0x004000h 0x007FFEh 0x008000h 0x00FFFEh 0x010000h
	GS = 35840 IW	0x0157FEh	GS = 35840 IW	0x0157FEh	GS = 35840 IW	0x0157FEh	GS = 35840 IW	0x0157FEh
SSS<2:0> = x00 16K	VS = 256 IW	0x000000h 0x0001FEh 0x000200h 0x0007FEh 0x000800h 0x001FFEh 0x002000h 0x003FFEh 0x004000h 0x007FFEh 0x008000h 0x00FFFEh 0x010000h	VS = 256 IW BS = 768 IW SS = 15360 IW	0x000000h 0x0001FEh 0x000200h 0x0007FEh 0x000800h 0x001FFEh 0x002000h 0x003FFEh 0x004000h 0x007FFEh 0x008000h 0x00FFFEh 0x010000h	VS = 256 IW BS = 3840 IW SS = 12288 IW	0x000000h 0x0001FEh 0x000200h 0x0007FEh 0x000800h 0x001FFEh 0x002000h 0x003FFEh 0x004000h 0x007FFEh 0x008000h 0x00FFFEh 0x010000h	VS = 256 IW BS = 7936 IW SS = 8192 IW	0x000000h 0x0001FEh 0x000200h 0x0007FEh 0x000800h 0x001FFEh 0x002000h 0x003FFEh 0x004000h 0x007FFEh 0x008000h 0x00FFFEh 0x010000h
	GS = 27648 IW	0x0157FEh	GS = 27648 IW	0x0157FEh	GS = 27648 IW	0x0157FEh	GS = 27648 IW	0x0157FEh

26.0 INSTRUCTION SET SUMMARY

Note: This data sheet summarizes the features of the PIC24HJ32GP302/304, PIC24HJ64GPX02/X04 and PIC24HJ128GPX02/X04 families of devices. It is not intended to be a comprehensive reference source. To complement the information in this data sheet, refer to the “*dsPIC33F/PIC24H Family Reference Manual*”. Please see the Microchip web site (www.microchip.com) for the latest dsPIC33F/PIC24H Family Reference Manual sections.

The PIC24H instruction set is identical to the PIC24F, and is a subset of the dsPIC30F/33F instruction set.

Most instructions are a single program memory word (24 bits). Only three instructions require two program memory locations.

Each single-word instruction is a 24-bit word, divided into an 8-bit opcode, which specifies the instruction type and one or more operands, which further specify the operation of the instruction.

The instruction set is highly orthogonal and is grouped into five basic categories:

- Word or byte-oriented operations
- Bit-oriented operations
- Literal operations
- Control operations

Table 26-1 shows the general symbols used in describing the instructions.

The PIC24H instruction set summary in Table 26-2 lists all the instructions, along with the status flags affected by each instruction.

Most word or byte-oriented W register instructions (including barrel shift instructions) have three operands:

- The first source operand which is typically a register ‘Wb’ without any address modifier
- The second source operand which is typically a register ‘Ws’ with or without an address modifier
- The destination of the result which is typically a register ‘Wd’ with or without an address modifier

However, word or byte-oriented file register instructions have two operands:

- The file register specified by the value ‘f’
- The destination, which could either be the file register ‘f’ or the W0 register, which is denoted as ‘WREG’

Most bit-oriented instructions (including simple rotate/shift instructions) have two operands:

- The W register (with or without an address modifier) or file register (specified by the value of ‘Ws’ or ‘f’)
- The bit in the W register or file register (specified by a literal value or indirectly by the contents of register ‘Wb’)

The literal instructions that involve data movement may use some of the following operands:

- A literal value to be loaded into a W register or file register (specified by the value of ‘k’)
- The W register or file register where the literal value is to be loaded (specified by ‘Wb’ or ‘f’)

However, literal instructions that involve arithmetic or logical operations use some of the following operands:

- The first source operand which is a register ‘Wb’ without any address modifier
- The second source operand which is a literal value
- The destination of the result (only if not the same as the first source operand) which is typically a register ‘Wd’ with or without an address modifier

The control instructions may use some of the following operands:

- A program memory address
- The mode of the table read and table write instructions

All instructions are a single word, except for certain double word instructions, which were made double word instructions so that all the required information is available in these 48 bits. In the second word, the 8 MSBs are ‘0’s. If this second word is executed as an instruction (by itself), it will execute as a NOP.

Most single-word instructions are executed in a single instruction cycle, unless a conditional test is true, or the program counter is changed as a result of the instruction. In these cases, the execution takes two instruction cycles with the additional instruction cycle(s) executed as a NOP. Notable exceptions are the BRA (unconditional/computed branch), indirect CALL/GOTO, all table reads and writes and RETURN/RETFIE instructions, which are single-word instructions but take two or three cycles. Certain instructions that involve skipping over the subsequent instruction require either two or three cycles if the skip is performed, depending on whether the instruction being skipped is a single-word or double word instruction. Moreover, double word moves require two cycles. The double word instructions execute in two instruction cycles.

Note: For more details on the instruction set, refer to the “*16-bit MCU and DSC Programmer’s Reference Manual*” (DS70157).

TABLE 26-1: SYMBOLS USED IN OPCODE DESCRIPTIONS

Field	Description
#text	Means literal defined by "text"
(text)	Means "content of text"
[text]	Means "the location addressed by text"
{ }	Optional field or operation
<n:m>	Register bit field
.b	Byte mode selection
.d	Double Word mode selection
.S	Shadow register select
.w	Word mode selection (default)
bit4	4-bit bit selection field (used in word addressed instructions) $\in \{0...15\}$
C, DC, N, OV, Z	MCU Status bits: Carry, Digit Carry, Negative, Overflow, Sticky Zero
Expr	Absolute address, label or expression (resolved by the linker)
f	File register address $\in \{0x0000...0x1FFF\}$
lit1	1-bit unsigned literal $\in \{0,1\}$
lit4	4-bit unsigned literal $\in \{0...15\}$
lit5	5-bit unsigned literal $\in \{0...31\}$
lit8	8-bit unsigned literal $\in \{0...255\}$
lit10	10-bit unsigned literal $\in \{0...255\}$ for Byte mode, $\{0:1023\}$ for Word mode
lit14	14-bit unsigned literal $\in \{0...16384\}$
lit16	16-bit unsigned literal $\in \{0...65535\}$
lit23	23-bit unsigned literal $\in \{0...8388608\}$; LSB must be '0'
None	Field does not require an entry, may be blank
PC	Program Counter
Slit10	10-bit signed literal $\in \{-512...511\}$
Slit16	16-bit signed literal $\in \{-32768...32767\}$
Slit6	6-bit signed literal $\in \{-16...16\}$
Wb	Base W register $\in \{W0..W15\}$
Wd	Destination W register $\in \{Wd, [Wd], [Wd++] , [Wd--], [++Wd], [--Wd] \}$
Wdo	Destination W register $\in \{Wnd, [Wnd], [Wnd++] , [Wnd--], [++Wnd], [--Wnd], [Wnd+Wb] \}$
Wm,Wn	Dividend, Divisor working register pair (direct addressing)
Wm*Wm	Multiplicand and Multiplier working register pair for Square instructions $\in \{W4 * W4, W5 * W5, W6 * W6, W7 * W7\}$
Wn	One of 16 working registers $\in \{W0..W15\}$
Wnd	One of 16 destination working registers $\in \{W0...W15\}$
Wns	One of 16 source working registers $\in \{W0...W15\}$
WREG	W0 (working register used in file register instructions)
Ws	Source W register $\in \{Ws, [Ws], [Ws++] , [Ws--], [++Ws], [--Ws] \}$
Wso	Source W register $\in \{Wns, [Wns], [Wns++] , [Wns--], [++Wns], [--Wns], [Wns+Wb] \}$

TABLE 26-2: INSTRUCTION SET OVERVIEW

Base Instr #	Assembly Mnemonic	Assembly Syntax	Description	# of Words	# of Cycles	Status Flags Affected
1	ADD	ADD <i>f</i>	$f = f + WREG$	1	1	C,DC,N,OV,Z
		ADD <i>f</i> , WREG	$WREG = f + WREG$	1	1	C,DC,N,OV,Z
		ADD #lit10, Wn	$Wd = lit10 + Wd$	1	1	C,DC,N,OV,Z
		ADD Wb, Ws, Wd	$Wd = Wb + Ws$	1	1	C,DC,N,OV,Z
		ADD Wb, #lit5, Wd	$Wd = Wb + lit5$	1	1	C,DC,N,OV,Z
2	ADDC	ADDC <i>f</i>	$f = f + WREG + (C)$	1	1	C,DC,N,OV,Z
		ADDC <i>f</i> , WREG	$WREG = f + WREG + (C)$	1	1	C,DC,N,OV,Z
		ADDC #lit10, Wn	$Wd = lit10 + Wd + (C)$	1	1	C,DC,N,OV,Z
		ADDC Wb, Ws, Wd	$Wd = Wb + Ws + (C)$	1	1	C,DC,N,OV,Z
		ADDC Wb, #lit5, Wd	$Wd = Wb + lit5 + (C)$	1	1	C,DC,N,OV,Z
3	AND	AND <i>f</i>	$f = f .AND. WREG$	1	1	N,Z
		AND <i>f</i> , WREG	$WREG = f .AND. WREG$	1	1	N,Z
		AND #lit10, Wn	$Wd = lit10 .AND. Wd$	1	1	N,Z
		AND Wb, Ws, Wd	$Wd = Wb .AND. Ws$	1	1	N,Z
		AND Wb, #lit5, Wd	$Wd = Wb .AND. lit5$	1	1	N,Z
4	ASR	ASR <i>f</i>	$f = \text{Arithmetic Right Shift } f$	1	1	C,N,OV,Z
		ASR <i>f</i> , WREG	$WREG = \text{Arithmetic Right Shift } f$	1	1	C,N,OV,Z
		ASR Ws, Wd	$Wd = \text{Arithmetic Right Shift } Ws$	1	1	C,N,OV,Z
		ASR Wb, Wns, Wnd	$Wnd = \text{Arithmetic Right Shift } Wb \text{ by } Wns$	1	1	N,Z
		ASR Wb, #lit5, Wnd	$Wnd = \text{Arithmetic Right Shift } Wb \text{ by } lit5$	1	1	N,Z
5	BCLR	BCLR <i>f</i> , #bit4	Bit Clear <i>f</i>	1	1	None
		BCLR Ws, #bit4	Bit Clear Ws	1	1	None
6	BRA	BRA C, Expr	Branch if Carry	1	1 (2)	None
		BRA GE, Expr	Branch if greater than or equal	1	1 (2)	None
		BRA GEU, Expr	Branch if unsigned greater than or equal	1	1 (2)	None
		BRA GT, Expr	Branch if greater than	1	1 (2)	None
		BRA GTU, Expr	Branch if unsigned greater than	1	1 (2)	None
		BRA LE, Expr	Branch if less than or equal	1	1 (2)	None
		BRA LEU, Expr	Branch if unsigned less than or equal	1	1 (2)	None
		BRA LT, Expr	Branch if less than	1	1 (2)	None
		BRA LTU, Expr	Branch if unsigned less than	1	1 (2)	None
		BRA N, Expr	Branch if Negative	1	1 (2)	None
		BRA NC, Expr	Branch if Not Carry	1	1 (2)	None
		BRA NN, Expr	Branch if Not Negative	1	1 (2)	None
		BRA NZ, Expr	Branch if Not Zero	1	1 (2)	None
		BRA Expr	Branch Unconditionally	1	2	None
		BRA Z, Expr	Branch if Zero	1	1 (2)	None
BRA Wn	Computed Branch	1	2	None		
7	BSET	BSET <i>f</i> , #bit4	Bit Set <i>f</i>	1	1	None
		BSET Ws, #bit4	Bit Set Ws	1	1	None
8	BSW	BSW.C Ws, Wb	Write C bit to Ws<Wb>	1	1	None
		BSW.Z Ws, Wb	Write Z bit to Ws<Wb>	1	1	None
9	BTG	BTG <i>f</i> , #bit4	Bit Toggle <i>f</i>	1	1	None
		BTG Ws, #bit4	Bit Toggle Ws	1	1	None
10	BTSC	BTSC <i>f</i> , #bit4	Bit Test <i>f</i> , Skip if Clear	1	1 (2 or 3)	None
		BTSC Ws, #bit4	Bit Test Ws, Skip if Clear	1	1 (2 or 3)	None
11	BTSS	BTSS <i>f</i> , #bit4	Bit Test <i>f</i> , Skip if Set	1	1 (2 or 3)	None
		BTSS Ws, #bit4	Bit Test Ws, Skip if Set	1	1 (2 or 3)	None

PIC24HJ32GP302/304, PIC24HJ64GPX02/X04 AND PIC24HJ128GPX02/X04

TABLE 26-2: INSTRUCTION SET OVERVIEW (CONTINUED)

Base Instr #	Assembly Mnemonic	Assembly Syntax	Description	# of Words	# of Cycles	Status Flags Affected
12	BTST	BTST <i>f</i> , #bit4	Bit Test <i>f</i>	1	1	Z
		BTST.C <i>Ws</i> , #bit4	Bit Test <i>Ws</i> to C	1	1	C
		BTST.Z <i>Ws</i> , #bit4	Bit Test <i>Ws</i> to Z	1	1	Z
		BTST.C <i>Ws</i> , <i>Wb</i>	Bit Test <i>Ws</i> < <i>Wb</i> > to C	1	1	C
		BTST.Z <i>Ws</i> , <i>Wb</i>	Bit Test <i>Ws</i> < <i>Wb</i> > to Z	1	1	Z
13	BTSTS	BTSTS <i>f</i> , #bit4	Bit Test then Set <i>f</i>	1	1	Z
		BTSTS.C <i>Ws</i> , #bit4	Bit Test <i>Ws</i> to C, then Set	1	1	C
		BTSTS.Z <i>Ws</i> , #bit4	Bit Test <i>Ws</i> to Z, then Set	1	1	Z
14	CALL	CALL <i>lit</i> 23	Call subroutine	2	2	None
		CALL <i>Wn</i>	Call indirect subroutine	1	2	None
15	CLR	CLR <i>f</i>	<i>f</i> = 0x0000	1	1	None
		CLR WREG	WREG = 0x0000	1	1	None
		CLR <i>Ws</i>	<i>Ws</i> = 0x0000	1	1	None
16	CLRWDT	CLRWDT	Clear Watchdog Timer	1	1	WDTO, Sleep
17	COM	COM <i>f</i>	$f = \bar{f}$	1	1	N, Z
		COM <i>f</i> , WREG	$WREG = \bar{f}$	1	1	N, Z
		COM <i>Ws</i> , <i>Wd</i>	$Wd = \overline{Ws}$	1	1	N, Z
18	CP	CP <i>f</i>	Compare <i>f</i> with WREG	1	1	C, DC, N, OV, Z
		CP <i>Wb</i> , #lit5	Compare <i>Wb</i> with lit5	1	1	C, DC, N, OV, Z
		CP <i>Wb</i> , <i>Ws</i>	Compare <i>Wb</i> with <i>Ws</i> (<i>Wb</i> – <i>Ws</i>)	1	1	C, DC, N, OV, Z
19	CP0	CP0 <i>f</i>	Compare <i>f</i> with 0x0000	1	1	C, DC, N, OV, Z
		CP0 <i>Ws</i>	Compare <i>Ws</i> with 0x0000	1	1	C, DC, N, OV, Z
20	CPB	CPB <i>f</i>	Compare <i>f</i> with WREG, with Borrow	1	1	C, DC, N, OV, Z
		CPB <i>Wb</i> , #lit5	Compare <i>Wb</i> with lit5, with Borrow	1	1	C, DC, N, OV, Z
		CPB <i>Wb</i> , <i>Ws</i>	Compare <i>Wb</i> with <i>Ws</i> , with Borrow (<i>Wb</i> – <i>Ws</i> – C)	1	1	C, DC, N, OV, Z
21	CPSEQ	CPSEQ <i>Wb</i> , <i>Wn</i>	Compare <i>Wb</i> with <i>Wn</i> , skip if =	1	1 (2 or 3)	None
22	CPSGT	CPSGT <i>Wb</i> , <i>Wn</i>	Compare <i>Wb</i> with <i>Wn</i> , skip if >	1	1 (2 or 3)	None
23	CPSLT	CPSLT <i>Wb</i> , <i>Wn</i>	Compare <i>Wb</i> with <i>Wn</i> , skip if <	1	1 (2 or 3)	None
24	CPSNE	CPSNE <i>Wb</i> , <i>Wn</i>	Compare <i>Wb</i> with <i>Wn</i> , skip if ≠	1	1 (2 or 3)	None
25	DAW	DAW <i>Wn</i>	<i>Wn</i> = decimal adjust <i>Wn</i>	1	1	C
26	DEC	DEC <i>f</i>	<i>f</i> = <i>f</i> – 1	1	1	C, DC, N, OV, Z
		DEC <i>f</i> , WREG	WREG = <i>f</i> – 1	1	1	C, DC, N, OV, Z
		DEC <i>Ws</i> , <i>Wd</i>	<i>Wd</i> = <i>Ws</i> – 1	1	1	C, DC, N, OV, Z
27	DEC2	DEC2 <i>f</i>	<i>f</i> = <i>f</i> – 2	1	1	C, DC, N, OV, Z
		DEC2 <i>f</i> , WREG	WREG = <i>f</i> – 2	1	1	C, DC, N, OV, Z
		DEC2 <i>Ws</i> , <i>Wd</i>	<i>Wd</i> = <i>Ws</i> – 2	1	1	C, DC, N, OV, Z
28	DISI	DISI #lit14	Disable Interrupts for <i>k</i> instruction cycles	1	1	None
29	DIV	DIV.S <i>Wm</i> , <i>Wn</i>	Signed 16/16-bit Integer Divide	1	18	N, Z, C, OV
		DIV.SD <i>Wm</i> , <i>Wn</i>	Signed 32/16-bit Integer Divide	1	18	N, Z, C, OV
		DIV.U <i>Wm</i> , <i>Wn</i>	Unsigned 16/16-bit Integer Divide	1	18	N, Z, C, OV
		DIV.UD <i>Wm</i> , <i>Wn</i>	Unsigned 32/16-bit Integer Divide	1	18	N, Z, C, OV
30	EXCH	EXCH <i>Wns</i> , <i>Wnd</i>	Swap <i>Wns</i> with <i>Wnd</i>	1	1	None
31	FBCL	FBCL <i>Ws</i> , <i>Wnd</i>	Find Bit Change from Left (MSb) Side	1	1	C
32	FF1L	FF1L <i>Ws</i> , <i>Wnd</i>	Find First One from Left (MSb) Side	1	1	C
33	FF1R	FF1R <i>Ws</i> , <i>Wnd</i>	Find First One from Right (LSb) Side	1	1	C
34	GOTO	GOTO <i>Expr</i>	Go to address	2	2	None
		GOTO <i>Wn</i>	Go to indirect	1	2	None

TABLE 26-2: INSTRUCTION SET OVERVIEW (CONTINUED)

Base Instr #	Assembly Mnemonic	Assembly Syntax	Description	# of Words	# of Cycles	Status Flags Affected
35	INC	INC <i>f</i>	$f = f + 1$	1	1	C,DC,N,OV,Z
		INC <i>f</i> , WREG	WREG = $f + 1$	1	1	C,DC,N,OV,Z
		INC <i>Ws</i> , <i>Wd</i>	$Wd = Ws + 1$	1	1	C,DC,N,OV,Z
36	INC2	INC2 <i>f</i>	$f = f + 2$	1	1	C,DC,N,OV,Z
		INC2 <i>f</i> , WREG	WREG = $f + 2$	1	1	C,DC,N,OV,Z
		INC2 <i>Ws</i> , <i>Wd</i>	$Wd = Ws + 2$	1	1	C,DC,N,OV,Z
37	IOR	IOR <i>f</i>	$f = f .IOR$. WREG	1	1	N,Z
		IOR <i>f</i> , WREG	WREG = $f .IOR$. WREG	1	1	N,Z
		IOR #lit10, <i>Wn</i>	$Wd = lit10 .IOR$. <i>Wd</i>	1	1	N,Z
		IOR <i>Wb</i> , <i>Ws</i> , <i>Wd</i>	$Wd = Wb .IOR$. <i>Ws</i>	1	1	N,Z
		IOR <i>Wb</i> , #lit5, <i>Wd</i>	$Wd = Wb .IOR$. lit5	1	1	N,Z
38	LNK	LNK #lit14	Link Frame Pointer	1	1	None
39	LSR	LSR <i>f</i>	$f =$ Logical Right Shift f	1	1	C,N,OV,Z
		LSR <i>f</i> , WREG	WREG = Logical Right Shift f	1	1	C,N,OV,Z
		LSR <i>Ws</i> , <i>Wd</i>	$Wd =$ Logical Right Shift <i>Ws</i>	1	1	C,N,OV,Z
		LSR <i>Wb</i> , <i>Wns</i> , <i>Wnd</i>	$Wnd =$ Logical Right Shift <i>Wb</i> by <i>Wns</i>	1	1	N,Z
		LSR <i>Wb</i> , #lit5, <i>Wnd</i>	$Wnd =$ Logical Right Shift <i>Wb</i> by lit5	1	1	N,Z
40	MOV	MOV <i>f</i> , <i>Wn</i>	Move f to <i>Wn</i>	1	1	None
		MOV <i>f</i>	Move f to f	1	1	None
		MOV <i>f</i> , WREG	Move f to WREG	1	1	N,Z
		MOV #lit16, <i>Wn</i>	Move 16-bit literal to <i>Wn</i>	1	1	None
		MOV.b #lit8, <i>Wn</i>	Move 8-bit literal to <i>Wn</i>	1	1	None
		MOV <i>Wn</i> , f	Move <i>Wn</i> to f	1	1	None
		MOV <i>Wso</i> , <i>Wdo</i>	Move <i>Ws</i> to <i>Wd</i>	1	1	None
		MOV WREG, f	Move WREG to f	1	1	None
		MOV.D <i>Wns</i> , <i>Wd</i>	Move Double from $W(ns):W(ns + 1)$ to <i>Wd</i>	1	2	None
		MOV.D <i>Ws</i> , <i>Wnd</i>	Move Double from Ws to $W(nd + 1):W(nd)$	1	2	None
41	MUL	MUL.SS <i>Wb</i> , <i>Ws</i> , <i>Wnd</i>	$\{Wnd + 1, Wnd\} = signed(Wb) * signed(Ws)$	1	1	None
		MUL.SU <i>Wb</i> , <i>Ws</i> , <i>Wnd</i>	$\{Wnd + 1, Wnd\} = signed(Wb) * unsigned(Ws)$	1	1	None
		MUL.US <i>Wb</i> , <i>Ws</i> , <i>Wnd</i>	$\{Wnd + 1, Wnd\} = unsigned(Wb) * signed(Ws)$	1	1	None
		MUL.UU <i>Wb</i> , <i>Ws</i> , <i>Wnd</i>	$\{Wnd + 1, Wnd\} = unsigned(Wb) * unsigned(Ws)$	1	1	None
		MUL.SU <i>Wb</i> , #lit5, <i>Wnd</i>	$\{Wnd + 1, Wnd\} = signed(Wb) * unsigned(lit5)$	1	1	None
		MUL.UU <i>Wb</i> , #lit5, <i>Wnd</i>	$\{Wnd + 1, Wnd\} = unsigned(Wb) * unsigned(lit5)$	1	1	None
		MUL f	$W3:W2 = f * WREG$	1	1	None
42	NEG	NEG f	$f = \bar{f} + 1$	1	1	C,DC,N,OV,Z
		NEG f , WREG	WREG = $\bar{f} + 1$	1	1	C,DC,N,OV,Z
		NEG <i>Ws</i> , <i>Wd</i>	$Wd = \bar{Ws} + 1$	1	1	C,DC,N,OV,Z
43	NOP	NOP	No Operation	1	1	None
		NOPR	No Operation	1	1	None
44	POP	POP f	Pop f from Top-of-Stack (TOS)	1	1	None
		POP <i>Wdo</i>	Pop from Top-of-Stack (TOS) to <i>Wdo</i>	1	1	None
		POP.D <i>Wnd</i>	Pop from Top-of-Stack (TOS) to $W(nd):W(nd + 1)$	1	2	None
		POP.S	Pop Shadow Registers	1	1	All
45	PUSH	PUSH f	Push f to Top-of-Stack (TOS)	1	1	None
		PUSH <i>Wso</i>	Push <i>Wso</i> to Top-of-Stack (TOS)	1	1	None
		PUSH.D <i>Wns</i>	Push $W(ns):W(ns + 1)$ to Top-of-Stack (TOS)	1	2	None
		PUSH.S	Push Shadow Registers	1	1	None
46	PWRSVAV	PWRSVAV #lit1	Go into Sleep or Idle mode	1	1	WDTO,Sleep
47	RCALL	RCALL Expr	Relative Call	1	2	None
		RCALL <i>Wn</i>	Computed Call	1	2	None

TABLE 26-2: INSTRUCTION SET OVERVIEW (CONTINUED)

Base Instr #	Assembly Mnemonic	Assembly Syntax	Description	# of Words	# of Cycles	Status Flags Affected
48	REPEAT	REPEAT #lit14	Repeat Next Instruction lit14 + 1 times	1	1	None
		REPEAT Wn	Repeat Next Instruction (Wn) + 1 times	1	1	None
49	RESET	RESET	Software device Reset	1	1	None
50	RETFIE	RETFIE	Return from interrupt	1	3 (2)	None
51	RETLW	RETLW #lit10, Wn	Return with literal in Wn	1	3 (2)	None
52	RETURN	RETURN	Return from Subroutine	1	3 (2)	None
53	RLC	RLC f	f = Rotate Left through Carry f	1	1	C,N,Z
		RLC f, WREG	WREG = Rotate Left through Carry f	1	1	C,N,Z
		RLC Ws, Wd	Wd = Rotate Left through Carry Ws	1	1	C,N,Z
54	RLNC	RLNC f	f = Rotate Left (No Carry) f	1	1	N,Z
		RLNC f, WREG	WREG = Rotate Left (No Carry) f	1	1	N,Z
		RLNC Ws, Wd	Wd = Rotate Left (No Carry) Ws	1	1	N,Z
55	RRC	RRC f	f = Rotate Right through Carry f	1	1	C,N,Z
		RRC f, WREG	WREG = Rotate Right through Carry f	1	1	C,N,Z
		RRC Ws, Wd	Wd = Rotate Right through Carry Ws	1	1	C,N,Z
56	RRNC	RRNC f	f = Rotate Right (No Carry) f	1	1	N,Z
		RRNC f, WREG	WREG = Rotate Right (No Carry) f	1	1	N,Z
		RRNC Ws, Wd	Wd = Rotate Right (No Carry) Ws	1	1	N,Z
57	SE	SE Ws, Wnd	Wnd = sign-extended Ws	1	1	C,N,Z
58	SETM	SETM f	f = 0xFFFF	1	1	None
		SETM WREG	WREG = 0xFFFF	1	1	None
		SETM Ws	Ws = 0xFFFF	1	1	None
59	SL	SL f	f = Left Shift f	1	1	C,N,OV,Z
		SL f, WREG	WREG = Left Shift f	1	1	C,N,OV,Z
		SL Ws, Wd	Wd = Left Shift Ws	1	1	C,N,OV,Z
		SL Wb, Wns, Wnd	Wnd = Left Shift Wb by Wns	1	1	N,Z
		SL Wb, #lit5, Wnd	Wnd = Left Shift Wb by lit5	1	1	N,Z
60	SUB	SUB f	f = f - WREG	1	1	C,DC,N,OV,Z
		SUB f, WREG	WREG = f - WREG	1	1	C,DC,N,OV,Z
		SUB #lit10, Wn	Wn = Wn - lit10	1	1	C,DC,N,OV,Z
		SUB Wb, Ws, Wd	Wd = Wb - Ws	1	1	C,DC,N,OV,Z
		SUB Wb, #lit5, Wd	Wd = Wb - lit5	1	1	C,DC,N,OV,Z
61	SUBB	SUBB f	f = f - WREG - (\bar{C})	1	1	C,DC,N,OV,Z
		SUBB f, WREG	WREG = f - WREG - (\bar{C})	1	1	C,DC,N,OV,Z
		SUBB #lit10, Wn	Wn = Wn - lit10 - (\bar{C})	1	1	C,DC,N,OV,Z
		SUBB Wb, Ws, Wd	Wd = Wb - Ws - (\bar{C})	1	1	C,DC,N,OV,Z
		SUBB Wb, #lit5, Wd	Wd = Wb - lit5 - (\bar{C})	1	1	C,DC,N,OV,Z
62	SUBR	SUBR f	f = WREG - f	1	1	C,DC,N,OV,Z
		SUBR f, WREG	WREG = WREG - f	1	1	C,DC,N,OV,Z
		SUBR Wb, Ws, Wd	Wd = Ws - Wb	1	1	C,DC,N,OV,Z
		SUBR Wb, #lit5, Wd	Wd = lit5 - Wb	1	1	C,DC,N,OV,Z
63	SUBBR	SUBBR f	f = WREG - f - (\bar{C})	1	1	C,DC,N,OV,Z
		SUBBR f, WREG	WREG = WREG - f - (\bar{C})	1	1	C,DC,N,OV,Z
		SUBBR Wb, Ws, Wd	Wd = Ws - Wb - (\bar{C})	1	1	C,DC,N,OV,Z
		SUBBR Wb, #lit5, Wd	Wd = lit5 - Wb - (\bar{C})	1	1	C,DC,N,OV,Z
64	SWAP	SWAP.b Wn	Wn = nibble swap Wn	1	1	None
		SWAP Wn	Wn = byte swap Wn	1	1	None
65	TBLRDH	TBLRDH Ws, Wd	Read Prog<23:16> to Wd<7:0>	1	2	None
66	TBLRDL	TBLRDL Ws, Wd	Read Prog<15:0> to Wd	1	2	None
67	TBLWTH	TBLWTH Ws, Wd	Write Ws<7:0> to Prog<23:16>	1	2	None
68	TBLWTL	TBLWTL Ws, Wd	Write Ws to Prog<15:0>	1	2	None

TABLE 26-2: INSTRUCTION SET OVERVIEW (CONTINUED)

Base Instr #	Assembly Mnemonic	Assembly Syntax	Description	# of Words	# of Cycles	Status Flags Affected
69	ULNK	ULNK	Unlink Frame Pointer	1	1	None
70	XOR	XOR <i>f</i>	$f = f .XOR. WREG$	1	1	N,Z
		XOR <i>f</i> , WREG	$WREG = f .XOR. WREG$	1	1	N,Z
		XOR #lit10, Wn	$Wd = lit10 .XOR. Wd$	1	1	N,Z
		XOR Wb, Ws, Wd	$Wd = Wb .XOR. Ws$	1	1	N,Z
		XOR Wb, #lit5, Wd	$Wd = Wb .XOR. lit5$	1	1	N,Z
71	ZE	ZE Ws, Wnd	$Wnd = Zero-extend Ws$	1	1	C,Z,N

NOTES:

27.0 DEVELOPMENT SUPPORT

The PIC® microcontrollers and dsPIC® digital signal controllers are supported with a full range of software and hardware development tools:

- Integrated Development Environment
 - MPLAB® IDE Software
- Compilers/Assemblers/Linkers
 - MPLAB C Compiler for Various Device Families
 - HI-TECH C for Various Device Families
 - MPASM™ Assembler
 - MPLINK™ Object Linker/
MPLIB™ Object Librarian
 - MPLAB Assembler/Linker/Librarian for Various Device Families
- Simulators
 - MPLAB SIM Software Simulator
- Emulators
 - MPLAB REAL ICE™ In-Circuit Emulator
- In-Circuit Debuggers
 - MPLAB ICD 3
 - PICKit™ 3 Debug Express
- Device Programmers
 - PICKit™ 2 Programmer
 - MPLAB PM3 Device Programmer
- Low-Cost Demonstration/Development Boards, Evaluation Kits, and Starter Kits

27.1 MPLAB Integrated Development Environment Software

The MPLAB IDE software brings an ease of software development previously unseen in the 8/16/32-bit microcontroller market. The MPLAB IDE is a Windows® operating system-based application that contains:

- A single graphical interface to all debugging tools
 - Simulator
 - Programmer (sold separately)
 - In-Circuit Emulator (sold separately)
 - In-Circuit Debugger (sold separately)
- A full-featured editor with color-coded context
- A multiple project manager
- Customizable data windows with direct edit of contents
- High-level source code debugging
- Mouse over variable inspection
- Drag and drop variables from source to watch windows
- Extensive on-line help
- Integration of select third party tools, such as IAR C Compilers

The MPLAB IDE allows you to:

- Edit your source files (either C or assembly)
- One-touch compile or assemble, and download to emulator and simulator tools (automatically updates all project information)
- Debug using:
 - Source files (C or assembly)
 - Mixed C and assembly
 - Machine code

MPLAB IDE supports multiple debugging tools in a single development paradigm, from the cost-effective simulators, through low-cost in-circuit debuggers, to full-featured emulators. This eliminates the learning curve when upgrading to tools with increased flexibility and power.

27.2 MPLAB C Compilers for Various Device Families

The MPLAB C Compiler code development systems are complete ANSI C compilers for Microchip's PIC18, PIC24 and PIC32 families of microcontrollers and the dsPIC30 and dsPIC33 families of digital signal controllers. These compilers provide powerful integration capabilities, superior code optimization and ease of use.

For easy source level debugging, the compilers provide symbol information that is optimized to the MPLAB IDE debugger.

27.3 HI-TECH C for Various Device Families

The HI-TECH C Compiler code development systems are complete ANSI C compilers for Microchip's PIC family of microcontrollers and the dsPIC family of digital signal controllers. These compilers provide powerful integration capabilities, omniscient code generation and ease of use.

For easy source level debugging, the compilers provide symbol information that is optimized to the MPLAB IDE debugger.

The compilers include a macro assembler, linker, pre-processor, and one-step driver, and can run on multiple platforms.

27.4 MPASM Assembler

The MPASM Assembler is a full-featured, universal macro assembler for PIC10/12/16/18 MCUs.

The MPASM Assembler generates relocatable object files for the MPLINK Object Linker, Intel® standard HEX files, MAP files to detail memory usage and symbol reference, absolute LST files that contain source lines and generated machine code and COFF files for debugging.

The MPASM Assembler features include:

- Integration into MPLAB IDE projects
- User-defined macros to streamline assembly code
- Conditional assembly for multi-purpose source files
- Directives that allow complete control over the assembly process

27.5 MPLINK Object Linker/ MPLIB Object Librarian

The MPLINK Object Linker combines relocatable objects created by the MPASM Assembler and the MPLAB C18 C Compiler. It can link relocatable objects from precompiled libraries, using directives from a linker script.

The MPLIB Object Librarian manages the creation and modification of library files of precompiled code. When a routine from a library is called from a source file, only the modules that contain that routine will be linked in with the application. This allows large libraries to be used efficiently in many different applications.

The object linker/librarian features include:

- Efficient linking of single libraries instead of many smaller files
- Enhanced code maintainability by grouping related modules together
- Flexible creation of libraries with easy module listing, replacement, deletion and extraction

27.6 MPLAB Assembler, Linker and Librarian for Various Device Families

MPLAB Assembler produces relocatable machine code from symbolic assembly language for PIC24, PIC32 and dsPIC devices. MPLAB C Compiler uses the assembler to produce its object file. The assembler generates relocatable object files that can then be archived or linked with other relocatable object files and archives to create an executable file. Notable features of the assembler include:

- Support for the entire device instruction set
- Support for fixed-point and floating-point data
- Command line interface
- Rich directive set
- Flexible macro language
- MPLAB IDE compatibility

27.7 MPLAB SIM Software Simulator

The MPLAB SIM Software Simulator allows code development in a PC-hosted environment by simulating the PIC MCUs and dsPIC® DSCs on an instruction level. On any given instruction, the data areas can be examined or modified and stimuli can be applied from a comprehensive stimulus controller. Registers can be logged to files for further run-time analysis. The trace buffer and logic analyzer display extend the power of the simulator to record and track program execution, actions on I/O, most peripherals and internal registers.

The MPLAB SIM Software Simulator fully supports symbolic debugging using the MPLAB C Compilers, and the MPASM and MPLAB Assemblers. The software simulator offers the flexibility to develop and debug code outside of the hardware laboratory environment, making it an excellent, economical software development tool.

27.8 MPLAB REAL ICE In-Circuit Emulator System

MPLAB REAL ICE In-Circuit Emulator System is Microchip's next generation high-speed emulator for Microchip Flash DSC and MCU devices. It debugs and programs PIC® Flash MCUs and dsPIC® Flash DSCs with the easy-to-use, powerful graphical user interface of the MPLAB Integrated Development Environment (IDE), included with each kit.

The emulator is connected to the design engineer's PC using a high-speed USB 2.0 interface and is connected to the target with either a connector compatible with in-circuit debugger systems (RJ11) or with the new high-speed, noise tolerant, Low-Voltage Differential Signal (LVDS) interconnection (CAT5).

The emulator is field upgradable through future firmware downloads in MPLAB IDE. In upcoming releases of MPLAB IDE, new devices will be supported, and new features will be added. MPLAB REAL ICE offers significant advantages over competitive emulators including low-cost, full-speed emulation, run-time variable watches, trace analysis, complex breakpoints, a ruggedized probe interface and long (up to three meters) interconnection cables.

27.9 MPLAB ICD 3 In-Circuit Debugger System

MPLAB ICD 3 In-Circuit Debugger System is Microchip's most cost effective high-speed hardware debugger/programmer for Microchip Flash Digital Signal Controller (DSC) and microcontroller (MCU) devices. It debugs and programs PIC® Flash microcontrollers and dsPIC® DSCs with the powerful, yet easy-to-use graphical user interface of MPLAB Integrated Development Environment (IDE).

The MPLAB ICD 3 In-Circuit Debugger probe is connected to the design engineer's PC using a high-speed USB 2.0 interface and is connected to the target with a connector compatible with the MPLAB ICD 2 or MPLAB REAL ICE systems (RJ-11). MPLAB ICD 3 supports all MPLAB ICD 2 headers.

27.10 PICkit 3 In-Circuit Debugger/Programmer and PICkit 3 Debug Express

The MPLAB PICkit 3 allows debugging and programming of PIC® and dsPIC® Flash microcontrollers at a most affordable price point using the powerful graphical user interface of the MPLAB Integrated Development Environment (IDE). The MPLAB PICkit 3 is connected to the design engineer's PC using a full speed USB interface and can be connected to the target via an Microchip debug (RJ-11) connector (compatible with MPLAB ICD 3 and MPLAB REAL ICE). The connector uses two device I/O pins and the reset line to implement in-circuit debugging and In-Circuit Serial Programming™.

The PICkit 3 Debug Express include the PICkit 3, demo board and microcontroller, hookup cables and CDROM with user's guide, lessons, tutorial, compiler and MPLAB IDE software.

27.11 PICKit 2 Development Programmer/Debugger and PICKit 2 Debug Express

The PICKit™ 2 Development Programmer/Debugger is a low-cost development tool with an easy to use interface for programming and debugging Microchip's Flash families of microcontrollers. The full featured Windows® programming interface supports baseline (PIC10F, PIC12F5xx, PIC16F5xx), midrange (PIC12F6xx, PIC16F), PIC18F, PIC24, dsPIC30, dsPIC33, and PIC32 families of 8-bit, 16-bit, and 32-bit microcontrollers, and many Microchip Serial EEPROM products. With Microchip's powerful MPLAB Integrated Development Environment (IDE) the PICKit™ 2 enables in-circuit debugging on most PIC® microcontrollers. In-Circuit-Debugging runs, halts and single steps the program while the PIC microcontroller is embedded in the application. When halted at a breakpoint, the file registers can be examined and modified.

The PICKit 2 Debug Express include the PICKit 2, demo board and microcontroller, hookup cables and CDROM with user's guide, lessons, tutorial, compiler and MPLAB IDE software.

27.12 MPLAB PM3 Device Programmer

The MPLAB PM3 Device Programmer is a universal, CE compliant device programmer with programmable voltage verification at VDDMIN and VDDMAX for maximum reliability. It features a large LCD display (128 x 64) for menus and error messages and a modular, detachable socket assembly to support various package types. The ICSP™ cable assembly is included as a standard item. In Stand-Alone mode, the MPLAB PM3 Device Programmer can read, verify and program PIC devices without a PC connection. It can also set code protection in this mode. The MPLAB PM3 connects to the host PC via an RS-232 or USB cable. The MPLAB PM3 has high-speed communications and optimized algorithms for quick programming of large memory devices and incorporates an MMC card for file storage and data applications.

27.13 Demonstration/Development Boards, Evaluation Kits, and Starter Kits

A wide variety of demonstration, development and evaluation boards for various PIC MCUs and dsPIC DSCs allows quick application development on fully functional systems. Most boards include prototyping areas for adding custom circuitry and provide application firmware and source code for examination and modification.

The boards support a variety of features, including LEDs, temperature sensors, switches, speakers, RS-232 interfaces, LCD displays, potentiometers and additional EEPROM memory.

The demonstration and development boards can be used in teaching environments, for prototyping custom circuits and for learning about various microcontroller applications.

In addition to the PICDEM™ and dsPICDEM™ demonstration/development board series of circuits, Microchip has a line of evaluation kits and demonstration software for analog filter design, KEELOQ® security ICs, CAN, IrDA®, PowerSmart battery management, SEEVAL® evaluation system, Sigma-Delta ADC, flow rate sensing, plus many more.

Also available are starter kits that contain everything needed to experience the specified device. This usually includes a single application and debug capability, all on one board.

Check the Microchip web page (www.microchip.com) for the complete list of demonstration, development and evaluation kits.

28.0 ELECTRICAL CHARACTERISTICS

This section provides an overview of PIC24HJ32GP302/304, PIC24HJ64GPX02/X04 and PIC24HJ128GPX02/X04 electrical characteristics. Additional information is provided in future revisions of this document as it becomes available.

Absolute maximum ratings for the PIC24HJ32GP302/304, PIC24HJ64GPX02/X04 and PIC24HJ128GPX02/X04 family are listed below. Exposure to these maximum rating conditions for extended periods can affect device reliability. Functional operation of the device at these or any other conditions above the parameters indicated in the operation listings of this specification is not implied.

Absolute Maximum Ratings⁽¹⁾

Ambient temperature under bias.....	-40°C to +125°C
Storage temperature	-65°C to +160°C
Voltage on VDD with respect to Vss	-0.3V to +4.0V
Voltage on any pin that is not 5V tolerant with respect to Vss ⁽⁴⁾	-0.3V to (VDD + 0.3V)
Voltage on any 5V tolerant pin with respect to Vss when VDD ≥ 3.0V ⁽⁴⁾	-0.3V to +5.6V
Voltage on any 5V tolerant pin with respect to Vss when VDD < 3.0V ⁽⁴⁾	-0.3V to 3.6V
Maximum current out of Vss pin	300 mA
Maximum current into VDD pin ⁽²⁾	250 mA
Maximum current sourced/sunk by any 2x I/O pin ⁽³⁾	8 mA
Maximum current sourced/sunk by any 4x I/O pin ⁽³⁾	15 mA
Maximum current sourced/sunk by any 8x I/O pin ⁽³⁾	25 mA
Maximum current sunk by all ports	200 mA
Maximum current sourced by all ports ⁽²⁾	200 mA

Note 1: Stresses above those listed under “Absolute Maximum Ratings” can cause permanent damage to the device. This is a stress rating only, and functional operation of the device at those or any other conditions above those indicated in the operation listings of this specification is not implied. Exposure to maximum rating conditions for extended periods can affect device reliability.

- 2:** Maximum allowable current is a function of device maximum power dissipation (see [Table 28-2](#)).
- 3:** Exceptions are CLKOUT, which is able to sink/source 25 mA, and the VREF+, VREF-, SCLx, SDAx, PGECx and PGEDx pins, which are able to sink/source 12 mA.
- 4:** See the [“Pin Diagrams”](#) section for 5V tolerant pins.

28.1 DC Characteristics

TABLE 28-1: OPERATING MIPS VS. VOLTAGE

Characteristic	VDD Range (in Volts)	Temp Range (in °C)	Max MIPS
			PIC24HJ32GP302/304, PIC24HJ64GPX02/X04 and PIC24HJ128GPX02/X04
—	3.0-3.6V ⁽¹⁾	-40°C to +85°C	40
—	3.0-3.6V ⁽¹⁾	-40°C to +125°C	40

Note 1: Device is functional at $V_{BORMIN} < V_{DD} < V_{DDMIN}$. Analog modules such as the ADC will have degraded performance. Device functionality is tested but not characterized. Refer to parameter **BO10** in [Table 28-11](#) for the minimum and maximum BOR values.

TABLE 28-2: THERMAL OPERATING CONDITIONS

Rating	Symbol	Min	Typ	Max	Unit
Industrial Temperature Devices					
Operating Junction Temperature Range	TJ	-40	—	+125	°C
Operating Ambient Temperature Range	TA	-40	—	+85	°C
Extended Temperature Devices					
Operating Junction Temperature Range	TJ	-40	—	+155	°C
Operating Ambient Temperature Range	TA	-40	—	+125	°C
Power Dissipation: Internal chip power dissipation: $P_{INT} = V_{DD} \times (I_{DD} - \sum I_{OH})$ I/O Pin Power Dissipation: $I/O = \sum (\{V_{DD} - V_{OH}\} \times I_{OH}) + \sum (V_{OL} \times I_{OL})$	PD	PINT + PI/O			W
Maximum Allowed Power Dissipation	PDMAX	$(T_J - T_A)/\theta_{JA}$			W

TABLE 28-3: THERMAL PACKAGING CHARACTERISTICS

Characteristic	Symbol	Typ	Max	Unit	Notes
Package Thermal Resistance, 44-pin QFN	θ_{JA}	30	—	°C/W	1
Package Thermal Resistance, 44-pin TFQP	θ_{JA}	40	—	°C/W	1
Package Thermal Resistance, 28-pin SPDIP	θ_{JA}	45	—	°C/W	1
Package Thermal Resistance, 28-pin SOIC	θ_{JA}	50	—	°C/W	1
Package Thermal Resistance, 28-pin QFN-S	θ_{JA}	30	—	°C/W	1

Note 1: Junction to ambient thermal resistance, Theta-JA (θ_{JA}) numbers are achieved by package simulations.

TABLE 28-4: DC TEMPERATURE AND VOLTAGE SPECIFICATIONS

DC CHARACTERISTICS			Standard Operating Conditions: 3.0V to 3.6V (unless otherwise stated) Operating temperature -40°C ≤ TA ≤ +85°C for Industrial -40°C ≤ TA ≤ +125°C for Extended				
Param No.	Symbol	Characteristic	Min	Typ ⁽¹⁾	Max	Units	Conditions
Operating Voltage							
DC10	Supply Voltage						
	VDD		3.0	—	3.6	V	Industrial and Extended
DC12	VDR	RAM Data Retention Voltage⁽²⁾	1.8	—	—	V	—
DC16	VPOR	VDD Start Voltage to ensure internal Power-on Reset signal	—	—	VSS	V	—
DC17	SVDD	VDD Rise Rate to ensure internal Power-on Reset signal	0.03	—	—	V/ms	0-3.0V in 0.1s

- Note 1:** Data in “Typ” column is at 3.3V, 25°C unless otherwise stated.
Note 2: This is the limit to which VDD can be lowered without losing RAM data.

TABLE 28-5: DC CHARACTERISTICS: OPERATING CURRENT (IDD)

DC CHARACTERISTICS			Standard Operating Conditions: 3.0V to 3.6V (unless otherwise stated) Operating temperature -40°C ≤ TA ≤ +85°C for Industrial -40°C ≤ TA ≤ +125°C for Extended		
Parameter No. ⁽³⁾	Typical ⁽²⁾	Max	Units	Conditions	
Operating Current (IDD)⁽¹⁾					
DC20d	18	21	mA	-40°C	3.3V 10 MIPS
DC20a	18	22	mA	+25°C	
DC20b	18	22	mA	+85°C	
DC20c	18	25	mA	+125°C	
DC21d	30	35	mA	-40°C	3.3V 16 MIPS
DC21a	30	34	mA	+25°C	
DC21b	30	34	mA	+85°C	
DC21c	30	36	mA	+125°C	
DC22d	34	42	mA	-40°C	3.3V 20 MIPS
DC22a	34	41	mA	+25°C	
DC22b	34	42	mA	+85°C	
DC22c	35	44	mA	+125°C	
DC23d	49	58	mA	-40°C	3.3V 30 MIPS
DC23a	49	57	mA	+25°C	
DC23b	49	57	mA	+85°C	
DC23c	49	60	mA	+125°C	
DC24d	63	75	mA	-40°C	3.3V 40 MIPS
DC24a	63	74	mA	+25°C	
DC24b	63	74	mA	+85°C	
DC24c	63	76	mA	+125°C	

Note 1: IDD is primarily a function of the operating voltage and frequency. Other factors, such as I/O pin loading and switching rate, oscillator type, internal code execution pattern and temperature, also have an impact on the current consumption. The test conditions for all IDD measurements are as follows:

- Oscillator is configured in EC mode, no PLL until 10 MIPS, OSC1 is driven with external square wave from rail-to-rail (EC clock overshoot/undershoot < 250 mV required)
- CLKO is configured as an I/O input pin in the Configuration word
- All I/O pins are configured as inputs and pulled to Vss
- MCLR = VDD, WDT and FSCM are disabled
- CPU, SRAM, program memory and data memory are operational
- No peripheral modules are operating; however, every peripheral is being clocked (defined PMDx bits are set to zero)
- CPU executing `while(1)` statement
- JTAG is disabled

2: Data in “Typ” column is at 3.3V, +25°C unless otherwise stated.

3: These parameters are characterized but not tested in manufacturing.

TABLE 28-6: DC CHARACTERISTICS: IDLE CURRENT (IDLE)

DC CHARACTERISTICS			Standard Operating Conditions: 3.0V to 3.6V (unless otherwise stated) Operating temperature -40°C ≤ TA ≤ +85°C for Industrial -40°C ≤ TA ≤ +125°C for Extended		
Parameter No. ⁽³⁾	Typical ⁽²⁾	Max	Units	Conditions	
Idle Current (IDLE): Core OFF Clock ON Base Current⁽¹⁾					
DC40d	8	10	mA	-40°C	3.3V 10 MIPS
DC40a	8	10	mA	+25°C	
DC40b	9	10	mA	+85°C	
DC40c	10	13	mA	+125°C	
DC41d	13	15	mA	-40°C	3.3V 16 MIPS
DC41a	13	15	mA	+25°C	
DC41b	13	16	mA	+85°C	
DC41c	13	19	mA	+125°C	
DC42d	15	18	mA	-40°C	3.3V 20 MIPS
DC42a	16	18	mA	+25°C	
DC42b	16	19	mA	+85°C	
DC42c	17	22	mA	+125°C	
DC43a	23	27	mA	+25°C	3.3V 30 MIPS
DC43d	23	26	mA	-40°C	
DC43b	24	28	mA	+85°C	
DC43c	25	31	mA	+125°C	
DC44d	31	42	mA	-40°C	3.3V 40 MIPS
DC44a	31	36	mA	+25°C	
DC44b	32	39	mA	+85°C	
DC44c	34	43	mA	+125°C	

Note 1: Base IDLE current is measured as follows:

- CPU core is off (i.e., Idle mode), oscillator is configured in EC mode and external clock active, OSC1 is driven with external square wave from rail-to-rail (EC clock overshoot/undershoot < 250 mV required)
- CLKO is configured as an I/O input pin in the Configuration word
- External Secondary Oscillator disabled (i.e., SOSCO and SOSCI pins configured as digital I/O inputs)
- All I/O pins are configured as inputs and pulled to Vss
- MCLR = VDD, WDT and FSCM are disabled
- No peripheral modules are operating; however, every peripheral is being clocked (defined PMDx bits are set to zero)
- JTAG is disabled

2: Data in “Typ” column is at 3.3V, +25°C unless otherwise stated.

3: These parameters are characterized but not tested in manufacturing.

TABLE 28-7: DC CHARACTERISTICS: POWER-DOWN CURRENT (IPD)

DC CHARACTERISTICS			Standard Operating Conditions: 3.0V to 3.6V (unless otherwise stated) Operating temperature -40°C ≤ TA ≤ +85°C for Industrial -40°C ≤ TA ≤ +125°C for Extended		
Parameter No. ⁽³⁾	Typical ⁽²⁾	Max	Units	Conditions	
Power-Down Current (IPD)⁽¹⁾					
DC60d	24	68	μA	-40°C	3.3V Base Power-Down Current ^(3,4)
DC60a	28	87	μA	+25°C	
DC60b	124	292	μA	+85°C	
DC60c	350	1000	μA	+125°C	
DC61d	8	13	μA	-40°C	3.3V Watchdog Timer Current: ΔI _{WDT} ^(3,5)
DC61a	10	15	μA	+25°C	
DC61b	12	20	μA	+85°C	
DC61c	13	25	μA	+125°C	

Note 1: IPD (Sleep) current is measured as follows:

- CPU core is off (i.e., Sleep mode), oscillator is configured in EC mode and external clock active, OSC1 is driven with external square wave from rail-to-rail (EC clock overshoot/undershoot < 250 mV required)
- CLKO is configured as an I/O input pin in the Configuration word
- All I/O pins are configured as inputs and pulled to V_{SS}
- MCLR = V_{DD}, WDT and FSCM are disabled, all peripheral modules are disabled (PMDx bits are all '1's)
- RTCC is disabled
- JTAG is disabled

2: Data in the “Typ” column is at 3.3V, +25°C unless otherwise stated.

3: The Watchdog Timer Current is the additional current consumed when the WDT module is enabled. This current should be added to the base IPD current.

4: These currents are measured on the device containing the most memory in this family.

5: These parameters are characterized, but are not tested in manufacturing.

TABLE 28-8: DC CHARACTERISTICS: DOZE CURRENT (I_{DOZE})

DC CHARACTERISTICS			Standard Operating Conditions: 3.0V to 3.6V (unless otherwise stated) Operating temperature -40°C ≤ T _A ≤ +85°C for Industrial -40°C ≤ T _A ≤ +125°C for Extended				
Parameter No.	Typical ⁽¹⁾	Max	Doze Ratio	Units	Conditions		
DC73a	20	50	1:2	mA	-40°C	3.3V	40 MIPS
DC73f	17	30	1:64	mA			
DC73g	17	30	1:128	mA			
DC70a	20	50	1:2	mA	+25°C	3.3V	40 MIPS
DC70f	17	30	1:64	mA			
DC70g	17	30	1:128	mA			
DC71a	20	50	1:2	mA	+85°C	3.3V	40 MIPS
DC71f	17	30	1:64	mA			
DC71g	17	30	1:128	mA			
DC72a	21	50	1:2	mA	+125°C	3.3V	40 MIPS
DC72f	18	30	1:64	mA			
DC72g	18	30	1:128	mA			

Note 1: Data in the Typical column is at 3.3V, 25°C unless otherwise stated.

TABLE 28-9: DC CHARACTERISTICS: I/O PIN INPUT SPECIFICATIONS

DC CHARACTERISTICS			Standard Operating Conditions: 3.0V to 3.6V (unless otherwise stated) Operating temperature $-40^{\circ}\text{C} \leq T_A \leq +85^{\circ}\text{C}$ for Industrial $-40^{\circ}\text{C} \leq T_A \leq +125^{\circ}\text{C}$ for Extended				
Param No.	Symbol	Characteristic	Min	Typ ⁽¹⁾	Max	Units	Conditions
	V _{IL}	Input Low Voltage					
DI10		I/O pins	V _{SS}	—	0.2 V _{DD}	V	PMPTTL = 1
DI11		PMP pins	V _{SS}	—	0.15 V _{DD}	V	
DI15		MCLR	V _{SS}	—	0.2 V _{DD}	V	
DI16		I/O Pins with OSC1 or SOSCI	V _{SS}	—	0.2 V _{DD}	V	
DI18		I/O Pins with SDAx, SCLx	V _{SS}	—	0.3 V _{DD}	V	
DI19		I/O Pins with SDAx, SCLx	V _{SS}	—	0.8	V	
	V _{IH}	Input High Voltage					
DI20		I/O Pins Not 5V Tolerant ⁽⁴⁾	0.7 V _{DD}	—	V _{DD}	V	—
		I/O Pins 5V Tolerant ⁽⁴⁾	0.7 V _{DD}	—	5.5	V	
DI21		I/O Pins Not 5V Tolerant with PMP ⁽⁴⁾	0.24 V _{DD} + 0.8	—	V _{DD}	V	
		I/O Pins 5V Tolerant with PMP ⁽⁴⁾	0.24 V _{DD} + 0.8	—	5.5	V	
DI28		SDAx, SCLx	0.7 V _{DD}	—	5.5	V	SMBus disabled
DI29		SDAx, SCLx	2.1	—	5.5	V	SMBus enabled
DI30	ICNPU	CNx Pull-up Current					
			50	250	400	μA	V _{DD} = 3.3V, V _{PIN} = V _{SS}

- Note 1:** Data in “Typ” column is at 3.3V, 25°C unless otherwise stated.
- 2:** The leakage current on the MCLR pin is strongly dependent on the applied voltage level. The specified levels represent normal operating conditions. Higher leakage current can be measured at different input voltages.
- 3:** Negative current is defined as current sourced by the pin.
- 4:** See “[Pin Diagrams](#)” for the 5V tolerant I/O pins.
- 5:** V_{IL} source < (V_{SS} – 0.3). Characterized but not tested.
- 6:** Non-5V tolerant pins V_{IH} source > (V_{DD} + 0.3), 5V tolerant pins V_{IH} source > 5.5V. Characterized but not tested.
- 7:** Digital 5V tolerant pins cannot tolerate any “positive” input injection current from input sources > 5.5V.
- 8:** Injection currents > | 0 | can affect the ADC results by approximately 4-6 counts.
- 9:** Any number and/or combination of I/O pins not excluded under I_{ICL} or I_{ICH} conditions are permitted provided the mathematical “absolute instantaneous” sum of the input injection currents from all pins do not exceed the specified limit. Characterized but not tested.

TABLE 28-9: DC CHARACTERISTICS: I/O PIN INPUT SPECIFICATIONS

DC CHARACTERISTICS			Standard Operating Conditions: 3.0V to 3.6V (unless otherwise stated) Operating temperature $-40^{\circ}\text{C} \leq T_A \leq +85^{\circ}\text{C}$ for Industrial $-40^{\circ}\text{C} \leq T_A \leq +125^{\circ}\text{C}$ for Extended				
Param No.	Symbol	Characteristic	Min	Typ ⁽¹⁾	Max	Units	Conditions
DI50	I _{IL}	Input Leakage Current^(2,3) I/O pins 5V Tolerant ⁽⁴⁾	—	—	±2	μA	V _{SS} ≤ V _{PIN} ≤ V _{DD} , Pin at high-impedance
DI51		I/O Pins Not 5V Tolerant ⁽⁴⁾ (Excluding AN9 through AN12)	—	—	±1	μA	V _{SS} ≤ V _{PIN} ≤ V _{DD} , Pin at high-impedance, 40°C ≤ T _A ≤ +85°C
DI51a		I/O Pins Not 5V Tolerant ⁽⁴⁾	—	—	±2	μA	Shared with external reference pins, 40°C ≤ T _A ≤ +85°C
DI51b		I/O Pins Not 5V Tolerant ⁽⁴⁾ (Excluding AN9 through AN12)	—	—	±3.5	μA	V _{SS} ≤ V _{PIN} ≤ V _{DD} , Pin at high-impedance, -40°C ≤ T _A ≤ +125°C
DI51c		I/O Pins Not 5V Tolerant ⁽⁴⁾	—	—	±8	μA	Analog pins shared with external reference pins, -40°C ≤ T _A ≤ +125°C
DI51d		AN9 through AN12	—	—	±11	μA	V _{SS} ≤ V _{PIN} ≤ V _{DD} , Pin at high-impedance, -40°C ≤ T _A ≤ +85°C
DI51e		AN9 through AN12	—	—	±13	μA	V _{SS} ≤ V _{PIN} ≤ V _{DD} , Pin at high-impedance, -40°C ≤ T _A ≤ +125°C
DI55		<u>MCLR</u>	—	—	±2	μA	V _{SS} ≤ V _{PIN} ≤ V _{DD}
DI56		OSC1	—	—	±2	μA	V _{SS} ≤ V _{PIN} ≤ V _{DD} , XT and HS modes

- Note 1:** Data in “Typ” column is at 3.3V, 25°C unless otherwise stated.
- 2:** The leakage current on the MCLR pin is strongly dependent on the applied voltage level. The specified levels represent normal operating conditions. Higher leakage current can be measured at different input voltages.
- 3:** Negative current is defined as current sourced by the pin.
- 4:** See “[Pin Diagrams](#)” for the 5V tolerant I/O pins.
- 5:** V_{IL} source < (V_{SS} – 0.3). Characterized but not tested.
- 6:** Non-5V tolerant pins V_{IH} source > (V_{DD} + 0.3), 5V tolerant pins V_{IH} source > 5.5V. Characterized but not tested.
- 7:** Digital 5V tolerant pins cannot tolerate any “positive” input injection current from input sources > 5.5V.
- 8:** Injection currents > | 0 | can affect the ADC results by approximately 4-6 counts.
- 9:** Any number and/or combination of I/O pins not excluded under I_{ICL} or I_{ICH} conditions are permitted provided the mathematical “absolute instantaneous” sum of the input injection currents from all pins do not exceed the specified limit. Characterized but not tested.

TABLE 28-9: DC CHARACTERISTICS: I/O PIN INPUT SPECIFICATIONS

DC CHARACTERISTICS			Standard Operating Conditions: 3.0V to 3.6V (unless otherwise stated) Operating temperature -40°C ≤ TA ≤ +85°C for Industrial -40°C ≤ TA ≤ +125°C for Extended				
Param No.	Symbol	Characteristic	Min	Typ ⁽¹⁾	Max	Units	Conditions
DI60a	I _{ICL}	Input Low Injection Current	0	—	-5 ^(5,8)	mA	All pins except V _{DD} , V _{SS} , AV _{DD} , AV _{SS} , M _{CLR} , V _{CAP} , SOSC _I , SOSC _O , and RB14
DI60b	I _{ICH}	Input High Injection Current	0	—	+5 ^(6,7,8)	mA	All pins except V _{DD} , V _{SS} , AV _{DD} , AV _{SS} , M _{CLR} , V _{CAP} , SOSC _I , SOSC _O , RB14, and digital 5V-tolerant designated pins
DI60c	ΣI _{ICT}	Total Input Injection Current (sum of all I/O and control pins)	-20 ⁽⁹⁾	—	+20 ⁽⁹⁾	mA	Absolute instantaneous sum of all ± input injection currents from all I/O pins (I _{ICL} + I _{ICH}) ≤ ΣI _{ICT}

- Note 1:** Data in “Typ” column is at 3.3V, 25°C unless otherwise stated.
- 2:** The leakage current on the MCLR pin is strongly dependent on the applied voltage level. The specified levels represent normal operating conditions. Higher leakage current can be measured at different input voltages.
- 3:** Negative current is defined as current sourced by the pin.
- 4:** See “[Pin Diagrams](#)” for the 5V tolerant I/O pins.
- 5:** V_{IL} source < (V_{SS} – 0.3). Characterized but not tested.
- 6:** Non-5V tolerant pins V_{IH} source > (V_{DD} + 0.3), 5V tolerant pins V_{IH} source > 5.5V. Characterized but not tested.
- 7:** Digital 5V tolerant pins cannot tolerate any “positive” input injection current from input sources > 5.5V.
- 8:** Injection currents > | 0 | can affect the ADC results by approximately 4-6 counts.
- 9:** Any number and/or combination of I/O pins not excluded under I_{ICL} or I_{ICH} conditions are permitted provided the mathematical “absolute instantaneous” sum of the input injection currents from all pins do not exceed the specified limit. Characterized but not tested.

TABLE 28-10: DC CHARACTERISTICS: I/O PIN OUTPUT SPECIFICATIONS

DC CHARACTERISTICS			Standard Operating Conditions: 3.0V to 3.6V (unless otherwise stated) Operating temperature -40°C ≤ TA ≤ +85°C for Industrial -40°C ≤ TA ≤ +125°C for Extended					
Param.	Symbol	Characteristic	Min.	Typ.	Max.	Units	Conditions	
DO10	VOL	Output Low Voltage I/O Pins: 2x Sink Driver Pins - RA2, RA7- RA10, RB10, RB11, RB7, RB4, RC3-RC9	—	—	0.4	V	IOL ≤ 3 mA, VDD = 3.3V See Note 1	
		Output Low Voltage I/O Pins: 4x Sink Driver Pins - RA0, RA1, RB0-RB3, RB5, RB6, RB8, RB9, RB12-RB15, RC0-RC2	—	—	0.4	V	IOL ≤ 6 mA, VDD = 3.3V See Note 1	
		Output Low Voltage I/O Pins: 8x Sink Driver Pins - RA3, RA4	—	—	0.4	V	IOL ≤ 10 mA, VDD = 3.3V See Note 1	
DO20	VOH	Output High Voltage I/O Pins: 2x Source Driver Pins - RA2, RA7-RA10, RB4, RB7, RB10, RB11, RC3-RC9	2.4	—	—	V	IOH ≥ -3 mA, VDD = 3.3V See Note 1	
		Output High Voltage I/O Pins: 4x Source Driver Pins - RA0, RA1, RB0-RB3, RB5, RB6, RB8, RB9, RB12-RB15, RC0-RC2	2.4	—	—	V	IOH ≥ -6 mA, VDD = 3.3V See Note 1	
		Output High Voltage I/O Pins: 8x Source Driver Pins - RA4, RA3	2.4	—	—	V	IOH ≥ -10 mA, VDD = 3.3V See Note 1	
DO20A	VOH1	Output High Voltage I/O Pins: 2x Source Driver Pins - RA2, RA7-RA10, RB4, RB7, RB10, RB11, RC3-RC9	1.5	—	—	V	IOH ≥ -6 mA, VDD = 3.3V See Note 1	
			2.0	—	—		IOH ≥ -5 mA, VDD = 3.3V See Note 1	
			3.0	—	—		IOH ≥ -2 mA, VDD = 3.3V See Note 1	
		Output High Voltage 4x Source Driver Pins - RA0, RA1, RB0-RB3, RB5, RB6, RB8, RB9, RB12-RB15, RC0-RC2		1.5	—	—	V	IOH ≥ -12 mA, VDD = 3.3V See Note 1
				2.0	—	—		IOH ≥ -11 mA, VDD = 3.3V See Note 1
				3.0	—	—		IOH ≥ -3 mA, VDD = 3.3V See Note 1
		Output High Voltage I/O Pins: 8x Source Driver Pins - RA3, RA4		1.5	—	—	V	IOH ≥ -16 mA, VDD = 3.3V See Note 1
				2.0	—	—		IOH ≥ -12 mA, VDD = 3.3V See Note 1
				3.0	—	—		IOH ≥ -4 mA, VDD = 3.3V See Note 1

Note 1: Parameters are characterized, but not tested.

TABLE 28-11: ELECTRICAL CHARACTERISTICS: BOR

DC CHARACTERISTICS		Standard Operating Conditions: 3.0V to 3.6V (unless otherwise stated) Operating temperature -40°C ≤ TA ≤ +85°C for Industrial -40°C ≤ TA ≤ +125°C for Extended					
Param No.	Symbol	Characteristic	Min ⁽¹⁾	Typ	Max ⁽¹⁾	Units	Conditions
BO10	VBOR	BOR Event on VDD transition high-to-low	2.40	—	2.55	V	VDD

Note 1: Parameters are for design guidance only and are not tested in manufacturing.

TABLE 28-12: DC CHARACTERISTICS: PROGRAM MEMORY

DC CHARACTERISTICS		Standard Operating Conditions: 3.0V to 3.6V (unless otherwise stated) Operating temperature -40°C ≤ TA ≤ +85°C for Industrial -40°C ≤ TA ≤ +125°C for Extended						
Param No.	Symbol	Characteristic	Min	Typ ⁽¹⁾	Max	Units	Conditions	
		Program Flash Memory						
D130a	EP	Cell Endurance	10,000	—	—	E/W	-40°C to +125°C	
D131	VPR	VDD for Read	V _{MIN}	—	3.6	V	V _{MIN} = Minimum operating voltage	
D132B	VPEW	VDD for Self-Timed Write	V _{MIN}	—	3.6	V	V _{MIN} = Minimum operating voltage	
D134	TRETD	Characteristic Retention	20	—	—	Year	Provided no other specifications are violated	
D135	IDDP	Supply Current during Programming	—	10	—	mA	—	
D136a	TRW	Row Write Time	1.32	—	1.74	ms	TRW = 11064 FRC cycles, TA = +85°C, See Note 2	
D136b	TRW	Row Write Time	1.28	—	1.79	ms	TRW = 11064 FRC cycles, TA = +125°C, See Note 2	
D137a	TPE	Page Erase Time	20.1	—	26.5	ms	TPE = 168517 FRC cycles, TA = +85°C, See Note 2	
D137b	TPE	Page Erase Time	19.5	—	27.3	ms	TPE = 168517 FRC cycles, TA = +125°C, See Note 2	
D138a	T _{WW}	Word Write Cycle Time	42.3	—	55.9	μs	T _{WW} = 355 FRC cycles, TA = +85°C, See Note 2	
D138b	T _{WW}	Word Write Cycle Time	41.1	—	57.6	μs	T _{WW} = 355 FRC cycles, TA = +125°C, See Note 2	

Note 1: Data in “Typ” column is at 3.3V, 25°C unless otherwise stated.

2: Other conditions: FRC = 7.37 MHz, TUN<5:0> = b'011111 (for Min), TUN<5:0> = b'100000 (for Max). This parameter depends on the FRC accuracy (see Table 28-19) and the value of the FRC Oscillator Tuning register (see Register 9-4). For complete details on calculating the Minimum and Maximum time see Section 5.3 “Programming Operations”.

TABLE 28-13: INTERNAL VOLTAGE REGULATOR SPECIFICATIONS

Standard Operating Conditions (unless otherwise stated): Operating temperature -40°C ≤ TA ≤ +85°C for Industrial -40°C ≤ TA ≤ +125°C for Extended							
Param No.	Symbol	Characteristics	Min	Typ	Max	Units	Comments
—	CEFC	External Filter Capacitor Value ⁽¹⁾	4.7	10	—	μF	Capacitor must be low series resistance (< 5 Ohms)

Note 1: Typical VCAP voltage = 2.5V when VDD ≥ VDDMIN.

28.2 AC Characteristics and Timing Parameters

This section defines PIC24HJ32GP302/304, PIC24HJ64GPX02/X04 and PIC24HJ128GPX02/X04 AC characteristics and timing parameters.

TABLE 28-14: TEMPERATURE AND VOLTAGE SPECIFICATIONS – AC

AC CHARACTERISTICS	Standard Operating Conditions: 3.0V to 3.6V (unless otherwise stated)
	Operating temperature $-40^{\circ}\text{C} \leq T_A \leq +85^{\circ}\text{C}$ for Industrial $-40^{\circ}\text{C} \leq T_A \leq +125^{\circ}\text{C}$ for Extended Operating voltage V_{DD} range as described in Table 28-1 .

FIGURE 28-1: LOAD CONDITIONS FOR DEVICE TIMING SPECIFICATIONS



TABLE 28-15: CAPACITIVE LOADING REQUIREMENTS ON OUTPUT PINS

Param No.	Symbol	Characteristic	Min	Typ	Max	Units	Conditions
DO50	Cosc2	OSC2/SOSC2 pin	—	—	15	pF	In XT and HS modes when external clock is used to drive OSC1
DO56	Cio	All I/O pins and OSC2	—	—	50	pF	EC mode
DO58	CB	SCLx, SDAx	—	—	400	pF	In I ² C™ mode

FIGURE 28-2: EXTERNAL CLOCK TIMING



TABLE 28-16: EXTERNAL CLOCK TIMING REQUIREMENTS

AC CHARACTERISTICS			Standard Operating Conditions: 3.0V to 3.6V (unless otherwise stated) Operating temperature -40°C ≤ TA ≤ +85°C for Industrial -40°C ≤ TA ≤ +125°C for Extended				
Param No.	Symb	Characteristic	Min	Typ ⁽¹⁾	Max	Units	Conditions
OS10	FIN	External CLKI Frequency (External clocks allowed only in EC and ECPLL modes)	DC	—	40	MHz	EC
		Oscillator Crystal Frequency	3.5 10	— — —	10 40 33	MHz MHz kHz	XT HS SOSC
OS20	Tosc	Tosc = 1/Fosc	12.5	—	DC	ns	
OS25	Tcy	Instruction Cycle Time ⁽²⁾	25	—	DC	ns	
OS30	TosL, TosH	External Clock in (OSC1) High or Low Time	0.375 x Tosc	—	0.625 x Tosc	ns	EC
OS31	TosR, TosF	External Clock in (OSC1) Rise or Fall Time	—	—	20	ns	EC
OS40	TckR	CLKO Rise Time ⁽³⁾	—	5.2	—	ns	—
OS41	TckF	CLKO Fall Time ⁽³⁾	—	5.2	—	ns	—
OS42	GM	External Oscillator Transconductance ⁽⁴⁾	14	16	18	mA/V	VDD = 3.3V TA = +25°C

Note 1: Data in “Typ” column is at 3.3V, 25°C unless otherwise stated.

2: Instruction cycle period (Tcy) equals two times the input oscillator time-base period. All specified values are based on characterization data for that particular oscillator type under standard operating conditions with the device executing code. Exceeding these specified limits may result in an unstable oscillator operation and/or higher than expected current consumption. All devices are tested to operate at “min.” values with an external clock applied to the OSC1/CLKI pin. When an external clock input is used, the “max.” cycle time limit is “DC” (no clock) for all devices.

3: Measurements are taken in EC mode. The CLKO signal is measured on the OSC2 pin.

4: Data for this parameter is Preliminary. This parameter is characterized, but not tested in manufacturing.

TABLE 28-17: PLL CLOCK TIMING SPECIFICATIONS (V_{DD} = 3.0V TO 3.6V)

AC CHARACTERISTICS		Standard Operating Conditions: 3.0V to 3.6V (unless otherwise stated) Operating temperature -40°C ≤ T _A ≤ +85°C for Industrial -40°C ≤ T _A ≤ +125°C for Extended					
Param No.	Symbol	Characteristic	Min	Typ ⁽¹⁾	Max	Units	Conditions
OS50	FPLLI	PLL Voltage Controlled Oscillator (VCO) Input Frequency Range	0.8	—	8	MHz	ECPLL, HSPLL, XTPLL modes
OS51	FSYS	On-Chip VCO System Frequency	100	—	200	MHz	—
OS52	TLOCK	PLL Start-up Time (Lock Time)	0.9	1.5	3.1	mS	—
OS53	DCLK	CLKO Stability (Jitter)	-3	0.5	3	%	Measured over 100 ms period

- Note 1:** Data in “Typ” column is at 3.3V, 25°C unless otherwise stated. Parameters are for design guidance only and are not tested.
- 2:** These parameters are characterized by similarity, but are not tested in manufacturing. This specification is based on clock cycle by clock cycle measurements. To calculate the effective jitter for individual time bases or communication clocks use this formula:

$$Peripheral\ Clock\ Jitter = \frac{DCLK}{\sqrt{\left(\frac{FOSC}{Peripheral\ Bit\ Rate\ Clock}\right)}}$$

For example: Fosc = 32 MHz, DCLK = 3%, SPI bit rate clock, (i.e., SCK) is 2 MHz.

$$SPI\ SCK\ Jitter = \left[\frac{DCLK}{\sqrt{\left(\frac{32\ MHz}{2\ MHz}\right)}} \right] = \left[\frac{3\%}{\sqrt{16}} \right] = \left[\frac{3\%}{4} \right] = 0.75\%$$

TABLE 28-18: AC CHARACTERISTICS: INTERNAL RC ACCURACY

AC CHARACTERISTICS		Standard Operating Conditions: 3.0V to 3.6V (unless otherwise stated) Operating temperature -40°C ≤ T _A ≤ +85°C for Industrial -40°C ≤ T _A ≤ +125°C for Extended					
Param No.	Characteristic	Min	Typ	Max	Units	Conditions	
Internal FRC Accuracy @ 7.3728 MHz⁽¹⁾							
F20	FRC	-2	—	+2	%	-40°C ≤ T _A ≤ +85°C	V _{DD} = 3.0-3.6V
	FRC	-5	—	+5	%	-40°C ≤ T _A ≤ +125°C	V _{DD} = 3.0-3.6V

- Note 1:** Frequency calibrated at 25°C and 3.3V. TUN bits can be used to compensate for temperature drift.

TABLE 28-19: INTERNAL RC ACCURACY

AC CHARACTERISTICS		Standard Operating Conditions: 3.0V to 3.6V (unless otherwise stated) Operating temperature -40°C ≤ T _A ≤ +85°C for Industrial -40°C ≤ T _A ≤ +125°C for Extended					
Param No.	Characteristic	Min	Typ	Max	Units	Conditions	
LPRC @ 32.768 kHz⁽¹⁾							
F21	LPRC	-20	±6	+20	%	-40°C ≤ T _A ≤ +85°C	V _{DD} = 3.0-3.6V
	LPRC	-30	—	+30	%	-40°C ≤ T _A ≤ +125°C	V _{DD} = 3.0-3.6V

- Note 1:** Change of LPRC frequency as V_{DD} changes.

FIGURE 28-3: CLKO AND I/O TIMING CHARACTERISTICS



TABLE 28-20: I/O TIMING REQUIREMENTS

AC CHARACTERISTICS		Standard Operating Conditions: 3.0V to 3.6V (unless otherwise stated) Operating temperature -40°C ≤ TA ≤ +85°C for Industrial -40°C ≤ TA ≤ +125°C for Extended					
Param No.	Symbol	Characteristic	Min	Typ ⁽¹⁾	Max	Units	Conditions
DO31	TioR	Port Output Rise Time	—	10	25	ns	—
DO32	TioF	Port Output Fall Time	—	10	25	ns	—
DI35	TINP	INTx Pin High or Low Time (input)	20	—	—	ns	—
DI40	TRBP	CNx High or Low Time (input)	2	—	—	TCY	—

Note 1: Data in “Typ” column is at 3.3V, 25°C unless otherwise stated.

FIGURE 28-4: RESET, WATCHDOG TIMER, OSCILLATOR START-UP TIMER AND POWER-UP TIMER TIMING CHARACTERISTICS



TABLE 28-21: RESET, WATCHDOG TIMER, OSCILLATOR START-UP TIMER, POWER-UP TIMER TIMING REQUIREMENTS

AC CHARACTERISTICS			Standard Operating Conditions: 3.0V to 3.6V (unless otherwise stated) Operating temperature -40°C ≤ TA ≤ +85°C for Industrial -40°C ≤ TA ≤ +125°C for Extended				
Param No.	Symbol	Characteristic ⁽¹⁾	Min	Typ ⁽²⁾	Max	Units	Conditions
SY10	TMCL	MCLR Pulse Width (low)	2	—	—	μs	-40°C to +85°C
SY11	TPWRT	Power-up Timer Period	—	2 4 8 16 32 64 128	—	ms	-40°C to +85°C User programmable
SY12	TPOR	Power-on Reset Delay	3	10	30	μs	-40°C to +85°C
SY13	TIOZ	I/O High-Impedance from MCLR Low or Watchdog Timer Reset	0.68	0.72	1.2	μs	—
SY20	TWDT1	Watchdog Timer Time-out Period	—	—	—	—	See Section 25.4 “Watchdog Timer (WDT)” and LPRC specification F21 (Table 28-19)
SY30	TOST	Oscillator Start-up Timer Period	—	1024 T _{osc}	—	—	T _{osc} = OSC1 period
SY35	TFSCM	Fail-Safe Clock Monitor Delay	—	500	900	μs	-40°C to +85°C

Note 1: These parameters are characterized but not tested in manufacturing.

Note 2: Data in “Typ” column is at 3.3V, 25°C unless otherwise stated.

FIGURE 28-5: TIMER1, 2, 3 AND 4 EXTERNAL CLOCK TIMING CHARACTERISTICS



Note: Refer to Figure 28-1 for load conditions.

TABLE 28-22: TIMER1 EXTERNAL CLOCK TIMING REQUIREMENTS⁽¹⁾

AC CHARACTERISTICS		Standard Operating Conditions: 3.0V to 3.6V (unless otherwise stated) Operating temperature -40°C ≤ TA ≤ +85°C for Industrial -40°C ≤ TA ≤ +125°C for Extended						
Param No.	Symbol	Characteristic		Min	Typ	Max	Units	Conditions
TA10	TtXH	TxCK High Time	Synchronous, no prescaler	T _{CY} + 20	—	—	ns	Must also meet parameter TA15. N = prescale value (1, 8, 64, 256)
			Synchronous, with prescaler	(T _{CY} + 20)/N	—	—	ns	
			Asynchronous	20	—	—	ns	
TA11	TtXL	TxCK Low Time	Synchronous, no prescaler	(T _{CY} + 20)	—	—	ns	Must also meet parameter TA15. N = prescale value (1, 8, 64, 256)
			Synchronous, with prescaler	(T _{CY} + 20)/N	—	—	ns	
			Asynchronous	20	—	—	ns	
TA15	TtXP	TxCK Input Period	Synchronous, no prescaler	2 T _{CY} + 40	—	—	ns	—
			Synchronous, with prescaler	Greater of: 40 ns or (2 T _{CY} + 40)/N	—	—	—	N = prescale value (1, 8, 64, 256)
			Asynchronous	40	—	—	ns	—
OS60	Ft1	SOSCI/T1CK Oscillator Input frequency Range (oscillator enabled by setting bit TCS (T1CON<1>))		DC	—	50	kHz	—
TA20	TCKEXTMRL	Delay from External TxCK Clock Edge to Timer Increment		0.75 T _{CY} + 40	—	1.75 T _{CY} + 40	—	—

Note 1: Timer1 is a Type A.

TABLE 28-23: TIMER2 AND TIMER 4 EXTERNAL CLOCK TIMING REQUIREMENTS

AC CHARACTERISTICS				Standard Operating Conditions: 3.0V to 3.6V (unless otherwise stated) Operating temperature -40°C ≤TA ≤+85°C for Industrial -40°C ≤TA ≤+125°C for Extended				
Param No.	Symbol	Characteristic ⁽¹⁾		Min	Typ	Max	Units	Conditions
TB10	TtxH	TxCK High Time	Synchronous mode	Greater of: 20 or (TcY + 20)/N	—	—	ns	Must also meet parameter TB15 N = prescale value (1, 8, 64, 256)
TB11	TtxL	TxCK Low Time	Synchronous mode	Greater of: 20 or (TcY + 20)/N	—	—	ns	Must also meet parameter TB15 N = prescale value (1, 8, 64, 256)
TB15	TtxP	TxCK Input Period	Synchronous mode	Greater of: 40 or (2 TcY + 40)/N	—	—	ns	N = prescale value (1, 8, 64, 256)
TB20	TCKEXTMRL	Delay from External TxCK Clock Edge to Timer Increment		0.75 TcY + 40	—	1.75 TcY + 40	ns	

Note 1: These parameters are characterized, but are not tested in manufacturing.

TABLE 28-24: TIMER3 AND TIMER5 EXTERNAL CLOCK TIMING REQUIREMENTS

AC CHARACTERISTICS				Standard Operating Conditions: 3.0V to 3.6V (unless otherwise stated) Operating temperature -40°C ≤TA ≤+85°C for Industrial -40°C ≤TA ≤+125°C for Extended				
Param No.	Symbol	Characteristic ⁽¹⁾		Min	Typ	Max	Units	Conditions
TC10	TtxH	TxCK High Time	Synchronous	TcY + 20	—	—	ns	Must also meet parameter TC15
TC11	TtxL	TxCK Low Time	Synchronous	TcY + 20	—	—	ns	Must also meet parameter TC15
TC15	TtxP	TxCK Input Period	Synchronous, with prescaler	2 TcY + 40	—	—	ns	N = prescale value (1, 8, 64, 256)
TC20	TCKEXTMRL	Delay from External TxCK Clock Edge to Timer Increment		0.75 TcY + 40	—	1.75 TcY + 40	ns	

Note 1: These parameters are characterized, but are not tested in manufacturing.

FIGURE 28-6: INPUT CAPTURE (CAPx) TIMING CHARACTERISTICS

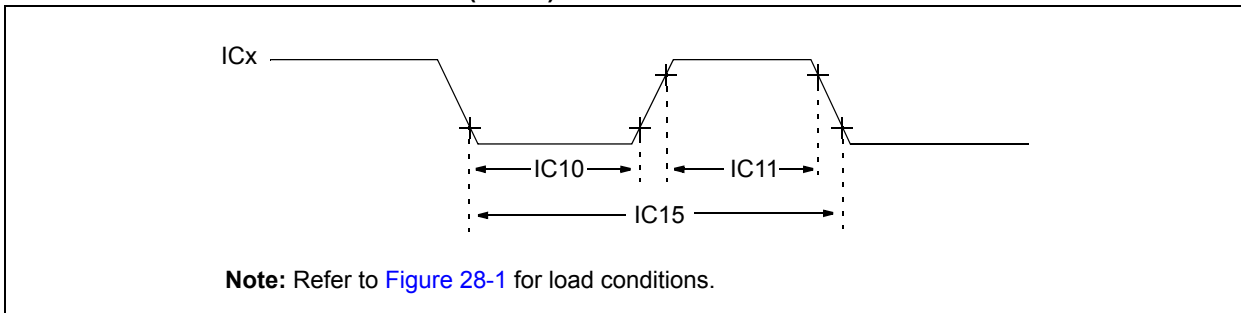

TABLE 28-25: INPUT CAPTURE TIMING REQUIREMENTS

AC CHARACTERISTICS		Standard Operating Conditions: 3.0V to 3.6V (unless otherwise stated) Operating temperature -40°C ≤ TA ≤ +85°C for Industrial -40°C ≤ TA ≤ +125°C for Extended					
Param No.	Symbol	Characteristic ⁽¹⁾		Min	Max	Units	Conditions
IC10	TccL	ICx Input Low Time	No Prescaler	0.5 Tcy + 20	—	ns	—
			With Prescaler	10	—	ns	
IC11	TccH	ICx Input High Time	No Prescaler	0.5 Tcy + 20	—	ns	—
			With Prescaler	10	—	ns	
IC15	TccP	ICx Input Period		(Tcy + 40)/N	—	ns	N = prescale value (1, 4, 16)

Note 1: These parameters are characterized but not tested in manufacturing.

FIGURE 28-7: OUTPUT COMPARE MODULE (OCx) TIMING CHARACTERISTICS

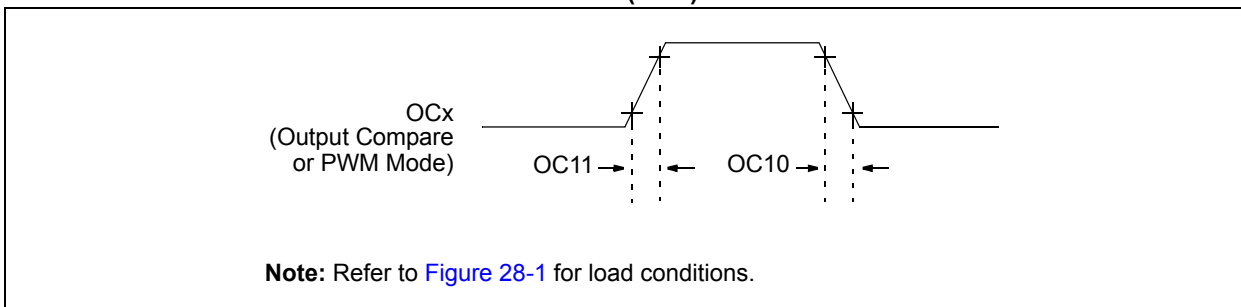

TABLE 28-26: OUTPUT COMPARE MODULE TIMING REQUIREMENTS

AC CHARACTERISTICS		Standard Operating Conditions: 3.0V to 3.6V (unless otherwise stated) Operating temperature -40°C ≤ TA ≤ +85°C for Industrial -40°C ≤ TA ≤ +125°C for Extended					
Param No.	Symbol	Characteristic ⁽¹⁾	Min	Typ	Max	Units	Conditions
OC10	TccF	OCx Output Fall Time	—	—	—	ns	See parameter DO32
OC11	TccR	OCx Output Rise Time	—	—	—	ns	See parameter DO31

Note 1: These parameters are characterized but not tested in manufacturing.

FIGURE 28-8: OC/PWM MODULE TIMING CHARACTERISTICS



TABLE 28-27: SIMPLE OC/PWM MODE TIMING REQUIREMENTS

AC CHARACTERISTICS			Standard Operating Conditions: 3.0V to 3.6V (unless otherwise stated) Operating temperature $-40^{\circ}\text{C} \leq T_A \leq +85^{\circ}\text{C}$ for Industrial $-40^{\circ}\text{C} \leq T_A \leq +125^{\circ}\text{C}$ for Extended				
Param No.	Symbol	Characteristic ⁽¹⁾	Min	Typ	Max	Units	Conditions
OC15	TFD	Fault Input to PWM I/O Change	—	—	$T_{CY} + 20$	ns	—
OC20	TFLT	Fault Input Pulse Width	$T_{CY} + 20$	—	—	ns	—

Note 1: These parameters are characterized but not tested in manufacturing.

TABLE 28-28: SPIx MAXIMUM DATA/CLOCK RATE SUMMARY

AC CHARACTERISTICS			Standard Operating Conditions: 3.0V to 3.6V (unless otherwise stated) Operating temperature -40°C ≤TA ≤+85°C for Industrial -40°C ≤TA ≤+125°C for Extended			
Maximum Data Rate	Master Transmit Only (Half-Duplex)	Master Transmit/Receive (Full-Duplex)	Slave Transmit/Receive (Full-Duplex)	CKE	CKP	SMP
15 MHz	Table 28-29	—	—	0,1	0,1	0,1
9 MHz	—	Table 28-30	—	1	0,1	1
9 MHz	—	Table 28-31	—	0	0,1	1
15 MHz	—	—	Table 28-32	1	0	0
11 MHz	—	—	Table 28-33	1	1	0
15 MHz	—	—	Table 28-34	0	1	0
11 MHz	—	—	Table 28-35	0	0	0

FIGURE 28-9: SPIx MASTER MODE (HALF-DUPLEX, TRANSMIT ONLY CKE = 0) TIMING CHARACTERISTICS



FIGURE 28-10: SPIx MASTER MODE (HALF-DUPLEX, TRANSMIT ONLY CKE = 1) TIMING CHARACTERISTICS



TABLE 28-29: SPIx MASTER MODE (HALF-DUPLEX, TRANSMIT ONLY) TIMING REQUIREMENTS

AC CHARACTERISTICS			Standard Operating Conditions: 3.0V to 3.6V (unless otherwise stated) Operating temperature -40°C ≤TA ≤+85°C for Industrial -40°C ≤TA ≤+125°C for Extended				
Param No.	Symbol	Characteristic ⁽¹⁾	Min	Typ ⁽²⁾	Max	Units	Conditions
SP10	TscP	Maximum SCK Frequency	—	—	15	MHz	See Note 3
SP20	TscF	SCKx Output Fall Time	—	—	—	ns	See parameter DO32 and Note 4
SP21	TscR	SCKx Output Rise Time	—	—	—	ns	See parameter DO31 and Note 4
SP30	TdoF	SDOx Data Output Fall Time	—	—	—	ns	See parameter DO32 and Note 4
SP31	TdoR	SDOx Data Output Rise Time	—	—	—	ns	See parameter DO31 and Note 4
SP35	Tsch2doV, TscL2doV	SDOx Data Output Valid after SCKx Edge	—	6	20	ns	—
SP36	TdiV2sch, TdiV2scL	SDOx Data Output Setup to First SCKx Edge	30	—	—	ns	—

- Note 1:** These parameters are characterized, but are not tested in manufacturing.
- Note 2:** Data in “Typ” column is at 3.3V, 25°C unless otherwise stated.
- Note 3:** The minimum clock period for SCKx is 66.7 ns. Therefore, the clock generated in Master mode must not violate this specification.
- Note 4:** Assumes 50 pF load on all SPIx pins.

FIGURE 28-11: SPIx MASTER MODE (FULL-DUPLEX, CKE = 1, CKP = x, SMP = 1) TIMING CHARACTERISTICS



TABLE 28-30: SPIx MASTER MODE (FULL-DUPLEX, CKE = 1, CKP = x, SMP = 1) TIMING REQUIREMENTS

AC CHARACTERISTICS			Standard Operating Conditions: 3.0V to 3.6V (unless otherwise stated) Operating temperature -40°C ≤TA ≤+85°C for Industrial -40°C ≤TA ≤+125°C for Extended				
Param No.	Symbol	Characteristic ⁽¹⁾	Min	Typ ⁽²⁾	Max	Units	Conditions
SP10	TscP	Maximum SCK Frequency	—	—	9	MHz	See Note 3
SP20	TscF	SCKx Output Fall Time	—	—	—	ns	See parameter DO32 and Note 4
SP21	TscR	SCKx Output Rise Time	—	—	—	ns	See parameter DO31 and Note 4
SP30	TdoF	SDOx Data Output Fall Time	—	—	—	ns	See parameter DO32 and Note 4
SP31	TdoR	SDOx Data Output Rise Time	—	—	—	ns	See parameter DO31 and Note 4
SP35	Tsch2doV, TscL2doV	SDOx Data Output Valid after SCKx Edge	—	6	20	ns	—
SP36	TdoV2sc, TdoV2scL	SDOx Data Output Setup to First SCKx Edge	30	—	—	ns	—
SP40	TdiV2sch, TdiV2scL	Setup Time of SDIx Data Input to SCKx Edge	30	—	—	ns	—
SP41	Tsch2diL, TscL2diL	Hold Time of SDIx Data Input to SCKx Edge	30	—	—	ns	—

- Note 1:** These parameters are characterized, but are not tested in manufacturing.
Note 2: Data in “Typ” column is at 3.3V, 25°C unless otherwise stated.
Note 3: The minimum clock period for SCKx is 111 ns. The clock generated in Master mode must not violate this specification.
Note 4: Assumes 50 pF load on all SPIx pins.

FIGURE 28-12: SPIx MASTER MODE (FULL-DUPLEX, CKE = 0, CKP = x, SMP = 1) TIMING CHARACTERISTICS



TABLE 28-31: SPIx MASTER MODE (FULL-DUPLEX, CKE = 0, CKP = x, SMP = 1) TIMING REQUIREMENTS

AC CHARACTERISTICS			Standard Operating Conditions: 3.0V to 3.6V (unless otherwise stated) Operating temperature -40°C ≤TA ≤+85°C for Industrial -40°C ≤TA ≤+125°C for Extended				
Param No.	Symbol	Characteristic ⁽¹⁾	Min	Typ ⁽²⁾	Max	Units	Conditions
SP10	TscP	Maximum SCK Frequency	—	—	9	MHz	-40°C to +125°C and see Note 3
SP20	TscF	SCKx Output Fall Time	—	—	—	ns	See parameter DO32 and Note 4
SP21	TscR	SCKx Output Rise Time	—	—	—	ns	See parameter DO31 and Note 4
SP30	TdoF	SDOx Data Output Fall Time	—	—	—	ns	See parameter DO32 and Note 4
SP31	TdoR	SDOx Data Output Rise Time	—	—	—	ns	See parameter DO31 and Note 4
SP35	Tsch2doV, TscL2doV	SDOx Data Output Valid after SCKx Edge	—	6	20	ns	—
SP36	TdoV2scH, TdoV2scL	SDOx Data Output Setup to First SCKx Edge	30	—	—	ns	—
SP40	TdiV2scH, TdiV2scL	Setup Time of SDIx Data Input to SCKx Edge	30	—	—	ns	—
SP41	Tsch2diL, TscL2diL	Hold Time of SDIx Data Input to SCKx Edge	30	—	—	ns	—

- Note 1:** These parameters are characterized, but are not tested in manufacturing.
- 2:** Data in “Typ” column is at 3.3V, 25°C unless otherwise stated.
- 3:** The minimum clock period for SCKx is 111 ns. The clock generated in Master mode must not violate this specification.
- 4:** Assumes 50 pF load on all SPIx pins.

FIGURE 28-13: SPIx SLAVE MODE (FULL-DUPLEX, CKE = 1, CKP = 0, SMP = 0) TIMING CHARACTERISTICS



TABLE 28-32: SPIx SLAVE MODE (FULL-DUPLEX, CKE = 1, CKP = 0, SMP = 0) TIMING REQUIREMENTS

AC CHARACTERISTICS			Standard Operating Conditions: 3.0V to 3.6V (unless otherwise stated) Operating temperature -40°C ≤TA ≤+85°C for Industrial -40°C ≤TA ≤+125°C for Extended				
Param No.	Symbol	Characteristic ⁽¹⁾	Min	Typ ⁽²⁾	Max	Units	Conditions
SP70	TscP	Maximum SCK Input Frequency	—	—	15	MHz	See Note 3
SP72	TscF	SCKx Input Fall Time	—	—	—	ns	See parameter DO32 and Note 4
SP73	TscR	SCKx Input Rise Time	—	—	—	ns	See parameter DO31 and Note 4
SP30	TdoF	SDOx Data Output Fall Time	—	—	—	ns	See parameter DO32 and Note 4
SP31	TdoR	SDOx Data Output Rise Time	—	—	—	ns	See parameter DO31 and Note 4
SP35	Tsch2doV, TscL2doV	SDOx Data Output Valid after SCKx Edge	—	6	20	ns	—
SP36	TdoV2sch, TdoV2scL	SDOx Data Output Setup to First SCKx Edge	30	—	—	ns	—
SP40	TdiV2sch, TdiV2scL	Setup Time of SDIx Data Input to SCKx Edge	30	—	—	ns	—
SP41	Tsch2diL, TscL2diL	Hold Time of SDIx Data Input to SCKx Edge	30	—	—	ns	—
SP50	TssL2sch, TssL2scL	$\overline{SSx} \downarrow$ to SCKx \uparrow or SCKx Input	120	—	—	ns	—
SP51	TssH2doZ	$\overline{SSx} \uparrow$ to SDOx Output High-Impedance ⁽⁴⁾	10	—	50	ns	—
SP52	Tsch2ssH TscL2ssH	\overline{SSx} after SCKx Edge	1.5 TcY + 40	—	—	ns	See Note 4
SP60	TssL2doV	SDOx Data Output Valid after \overline{SSx} Edge	—	—	50	ns	—

- Note 1:** These parameters are characterized, but are not tested in manufacturing.
- Note 2:** Data in “Typ” column is at 3.3V, 25°C unless otherwise stated.
- Note 3:** The minimum clock period for SCKx is 66.7 ns. Therefore, the SCK clock generated by the Master must not violate this specification.
- Note 4:** Assumes 50 pF load on all SPIx pins.

FIGURE 28-14: SPIx SLAVE MODE (FULL-DUPLEX, CKE = 1, CKP = 1, SMP = 0) TIMING CHARACTERISTICS



TABLE 28-33: SPIx SLAVE MODE (FULL-DUPLEX, CKE = 1, CKP = 1, SMP = 0) TIMING REQUIREMENTS

AC CHARACTERISTICS			Standard Operating Conditions: 3.0V to 3.6V (unless otherwise stated) Operating temperature -40°C ≤ TA ≤ +85°C for Industrial -40°C ≤ TA ≤ +125°C for Extended				
Param No.	Symbol	Characteristic ⁽¹⁾	Min	Typ ⁽²⁾	Max	Units	Conditions
SP70	TscP	Maximum SCK Input Frequency	—	—	11	MHz	See Note 3
SP72	TscF	SCKx Input Fall Time	—	—	—	ns	See parameter DO32 and Note 4
SP73	TscR	SCKx Input Rise Time	—	—	—	ns	See parameter DO31 and Note 4
SP30	TdoF	SDOx Data Output Fall Time	—	—	—	ns	See parameter DO32 and Note 4
SP31	TdoR	SDOx Data Output Rise Time	—	—	—	ns	See parameter DO31 and Note 4
SP35	Tsch2doV, TscL2doV	SDOx Data Output Valid after SCKx Edge	—	6	20	ns	—
SP36	TdoV2scH, TdoV2scL	SDOx Data Output Setup to First SCKx Edge	30	—	—	ns	—
SP40	TdiV2scH, TdiV2scL	Setup Time of SDIx Data Input to SCKx Edge	30	—	—	ns	—
SP41	Tsch2diL, TscL2diL	Hold Time of SDIx Data Input to SCKx Edge	30	—	—	ns	—
SP50	TssL2scH, TssL2scL	$\overline{SSx} \downarrow$ to SCKx \uparrow or SCKx Input	120	—	—	ns	—
SP51	TssH2doZ	$\overline{SSx} \uparrow$ to SDOx Output High-Impedance ⁽⁴⁾	10	—	50	ns	—
SP52	Tsch2ssH TscL2ssH	\overline{SSx} after SCKx Edge	1.5 Tcy + 40	—	—	ns	See Note 4
SP60	TssL2doV	SDOx Data Output Valid after \overline{SSx} Edge	—	—	50	ns	—

- Note 1:** These parameters are characterized, but are not tested in manufacturing.
Note 2: Data in “Typ” column is at 3.3V, 25°C unless otherwise stated.
Note 3: The minimum clock period for SCKx is 91 ns. Therefore, the SCK clock generated by the Master must not violate this specification.
Note 4: Assumes 50 pF load on all SPIx pins.

FIGURE 28-15: SPIx SLAVE MODE (FULL-DUPLEX CKE = 0, CKP = 1, SMP = 0) TIMING CHARACTERISTICS



TABLE 28-34: SPIx SLAVE MODE (FULL-DUPLEX, CKE = 0, CKP = 1, SMP = 0) TIMING REQUIREMENTS

AC CHARACTERISTICS			Standard Operating Conditions: 3.0V to 3.6V (unless otherwise stated) Operating temperature -40°C ≤TA ≤+85°C for Industrial -40°C ≤TA ≤+125°C for Extended				
Param No.	Symbol	Characteristic ⁽¹⁾	Min	Typ ⁽²⁾	Max	Units	Conditions
SP70	TscP	Maximum SCK Input Frequency	—	—	15	MHz	See Note 3
SP72	TscF	SCKx Input Fall Time	—	—	—	ns	See parameter DO32 and Note 4
SP73	TscR	SCKx Input Rise Time	—	—	—	ns	See parameter DO31 and Note 4
SP30	TdoF	SDOx Data Output Fall Time	—	—	—	ns	See parameter DO32 and Note 4
SP31	TdoR	SDOx Data Output Rise Time	—	—	—	ns	See parameter DO31 and Note 4
SP35	Tsch2doV, TscL2doV	SDOx Data Output Valid after SCKx Edge	—	6	20	ns	—
SP36	TdoV2sch, TdoV2scL	SDOx Data Output Setup to First SCKx Edge	30	—	—	ns	—
SP40	TdiV2sch, TdiV2scL	Setup Time of SDIx Data Input to SCKx Edge	30	—	—	ns	—
SP41	Tsch2diL, TscL2diL	Hold Time of SDIx Data Input to SCKx Edge	30	—	—	ns	—
SP50	TssL2sch, TssL2scL	$\overline{SSx} \downarrow$ to SCKx \uparrow or SCKx Input	120	—	—	ns	—
SP51	TssH2doZ	$\overline{SSx} \uparrow$ to SDOx Output High-Impedance ⁽⁴⁾	10	—	50	ns	—
SP52	Tsch2ssH TscL2ssH	\overline{SSx} after SCKx Edge	1.5 Tcy + 40	—	—	ns	See Note 4

- Note 1:** These parameters are characterized, but are not tested in manufacturing.
Note 2: Data in “Typ” column is at 3.3V, 25°C unless otherwise stated.
Note 3: The minimum clock period for SCKx is 66.7 ns. Therefore, the SCK clock generated by the Master must not violate this specification.
Note 4: Assumes 50 pF load on all SPIx pins.

FIGURE 28-16: SPIx SLAVE MODE (FULL-DUPLEX, CKE = 0, CKP = 0, SMP = 0) TIMING CHARACTERISTICS



TABLE 28-35: SPIx SLAVE MODE (FULL-DUPLEX, CKE = 0, CKP = 0, SMP = 0) TIMING REQUIREMENTS

AC CHARACTERISTICS			Standard Operating Conditions: 3.0V to 3.6V (unless otherwise stated) Operating temperature -40°C ≤TA ≤+85°C for Industrial -40°C ≤TA ≤+125°C for Extended				
Param No.	Symbol	Characteristic ⁽¹⁾	Min	Typ ⁽²⁾	Max	Units	Conditions
SP70	TscP	Maximum SCK Input Frequency	—	—	11	MHz	See Note 3
SP72	TscF	SCKx Input Fall Time	—	—	—	ns	See parameter DO32 and Note 4
SP73	TscR	SCKx Input Rise Time	—	—	—	ns	See parameter DO31 and Note 4
SP30	TdoF	SDOx Data Output Fall Time	—	—	—	ns	See parameter DO32 and Note 4
SP31	TdoR	SDOx Data Output Rise Time	—	—	—	ns	See parameter DO31 and Note 4
SP35	Tsch2doV, TscL2doV	SDOx Data Output Valid after SCKx Edge	—	6	20	ns	—
SP36	TdoV2sch, TdoV2scL	SDOx Data Output Setup to First SCKx Edge	30	—	—	ns	—
SP40	TdiV2sch, TdiV2scL	Setup Time of SDIx Data Input to SCKx Edge	30	—	—	ns	—
SP41	Tsch2diL, TscL2diL	Hold Time of SDIx Data Input to SCKx Edge	30	—	—	ns	—
SP50	TssL2sch, TssL2scL	$\overline{SSx} \downarrow$ to SCKx \uparrow or SCKx Input	120	—	—	ns	—
SP51	TssH2doZ	$\overline{SSx} \uparrow$ to SDOx Output High-Impedance ⁽⁴⁾	10	—	50	ns	—
SP52	Tsch2ssH TscL2ssH	\overline{SSx} after SCKx Edge	1.5 Tcy + 40	—	—	ns	See Note 4

- Note 1:** These parameters are characterized, but are not tested in manufacturing.
- Note 2:** Data in “Typ” column is at 3.3V, 25°C unless otherwise stated.
- Note 3:** The minimum clock period for SCKx is 91 ns. Therefore, the SCK clock generated by the Master must not violate this specification.
- Note 4:** Assumes 50 pF load on all SPIx pins.

FIGURE 28-17: I2Cx BUS START/STOP BITS TIMING CHARACTERISTICS (MASTER MODE)



FIGURE 28-18: I2Cx BUS DATA TIMING CHARACTERISTICS (MASTER MODE)



TABLE 28-36: I2Cx BUS DATA TIMING REQUIREMENTS (MASTER MODE)

AC CHARACTERISTICS			Standard Operating Conditions: 3.0V to 3.6V (unless otherwise stated) Operating temperature -40°C ≤ TA ≤ +85°C for Industrial -40°C ≤ TA ≤ +125°C for Extended				
Param No.	Symbol	Characteristic	Min ⁽¹⁾	Max	Units	Conditions	
IM10	TLO:SCL	Clock Low Time	100 kHz mode	Tcy/2 (BRG + 1)	—	µs	—
			400 kHz mode	Tcy/2 (BRG + 1)	—	µs	
			1 MHz mode ⁽²⁾	Tcy/2 (BRG + 1)	—	µs	
IM11	THI:SCL	Clock High Time	100 kHz mode	Tcy/2 (BRG + 1)	—	µs	—
			400 kHz mode	Tcy/2 (BRG + 1)	—	µs	
			1 MHz mode ⁽²⁾	Tcy/2 (BRG + 1)	—	µs	
IM20	TF:SCL	SDAx and SCLx Fall Time	100 kHz mode	—	300	ns	Cb is specified to be from 10 to 400 pF
			400 kHz mode	20 + 0.1 Cb	300	ns	
			1 MHz mode ⁽²⁾	—	100	ns	
IM21	TR:SCL	SDAx and SCLx Rise Time	100 kHz mode	—	1000	ns	Cb is specified to be from 10 to 400 pF
			400 kHz mode	20 + 0.1 Cb	300	ns	
			1 MHz mode ⁽²⁾	—	300	ns	
IM25	TSU:DAT	Data Input Setup Time	100 kHz mode	250	—	ns	—
			400 kHz mode	100	—	ns	
			1 MHz mode ⁽²⁾	40	—	ns	
IM26	THD:DAT	Data Input Hold Time	100 kHz mode	0	—	µs	—
			400 kHz mode	0	0.9	µs	
			1 MHz mode ⁽²⁾	0.2	—	µs	
IM30	TSU:STA	Start Condition Setup Time	100 kHz mode	Tcy/2 (BRG + 1)	—	µs	Only relevant for Repeated Start condition
			400 kHz mode	Tcy/2 (BRG + 1)	—	µs	
			1 MHz mode ⁽²⁾	Tcy/2 (BRG + 1)	—	µs	
IM31	THD:STA	Start Condition Hold Time	100 kHz mode	Tcy/2 (BRG + 1)	—	µs	After this period the first clock pulse is generated
			400 kHz mode	Tcy/2 (BRG + 1)	—	µs	
			1 MHz mode ⁽²⁾	Tcy/2 (BRG + 1)	—	µs	
IM33	TSU:STO	Stop Condition Setup Time	100 kHz mode	Tcy/2 (BRG + 1)	—	µs	—
			400 kHz mode	Tcy/2 (BRG + 1)	—	µs	
			1 MHz mode ⁽²⁾	Tcy/2 (BRG + 1)	—	µs	
IM34	THD:STO	Stop Condition Hold Time	100 kHz mode	Tcy/2 (BRG + 1)	—	ns	—
			400 kHz mode	Tcy/2 (BRG + 1)	—	ns	
			1 MHz mode ⁽²⁾	Tcy/2 (BRG + 1)	—	ns	
IM40	TAA:SCL	Output Valid From Clock	100 kHz mode	—	3500	ns	—
			400 kHz mode	—	1000	ns	
			1 MHz mode ⁽²⁾	—	400	ns	
IM45	TBF:SDA	Bus Free Time	100 kHz mode	4.7	—	µs	Time the bus must be free before a new transmission can start
			400 kHz mode	1.3	—	µs	
			1 MHz mode ⁽²⁾	0.5	—	µs	
IM50	CB	Bus Capacitive Loading	—	400	pF	—	
IM51	TPGD	Pulse Gobbler Delay	65	390	ns	See Note 3	

Note 1: BRG is the value of the I²C Baud Rate Generator. Refer to Section 19. “Inter-Integrated Circuit (I²C™)” (DS70235) in the “dsPIC33F/PIC24H Family Reference Manual”. Please see the Microchip web site (www.microchip.com) for the latest dsPIC33F/PIC24H Family Reference Manual chapters.

2: Maximum pin capacitance = 10 pF for all I2Cx pins (for 1 MHz mode only).

3: Typical value for this parameter is 130 ns.

FIGURE 28-19: I2Cx BUS START/STOP BITS TIMING CHARACTERISTICS (SLAVE MODE)



FIGURE 28-20: I2Cx BUS DATA TIMING CHARACTERISTICS (SLAVE MODE)



PIC24HJ32GP302/304, PIC24HJ64GPX02/X04 AND PIC24HJ128GPX02/X04

TABLE 28-37: I2Cx BUS DATA TIMING REQUIREMENTS (SLAVE MODE)

AC CHARACTERISTICS				Standard Operating Conditions: 3.0V to 3.6V (unless otherwise stated) Operating temperature -40°C ≤ TA ≤ +85°C for Industrial -40°C ≤ TA ≤ +125°C for Extended			
Param.	Symbol	Characteristic		Min	Max	Units	Conditions
IS10	TLO:SCL	Clock Low Time	100 kHz mode	4.7	—	μs	Device must operate at a minimum of 1.5 MHz
			400 kHz mode	1.3	—	μs	Device must operate at a minimum of 10 MHz
			1 MHz mode ⁽¹⁾	0.5	—	μs	—
IS11	THI:SCL	Clock High Time	100 kHz mode	4.0	—	μs	Device must operate at a minimum of 1.5 MHz
			400 kHz mode	0.6	—	μs	Device must operate at a minimum of 10 MHz
			1 MHz mode ⁽¹⁾	0.5	—	μs	—
IS20	TF:SCL	SDAx and SCLx Fall Time	100 kHz mode	—	300	ns	CB is specified to be from 10 to 400 pF
			400 kHz mode	20 + 0.1 CB	300	ns	
			1 MHz mode ⁽¹⁾	—	100	ns	
IS21	TR:SCL	SDAx and SCLx Rise Time	100 kHz mode	—	1000	ns	CB is specified to be from 10 to 400 pF
			400 kHz mode	20 + 0.1 CB	300	ns	
			1 MHz mode ⁽¹⁾	—	300	ns	
IS25	TSU:DAT	Data Input Setup Time	100 kHz mode	250	—	ns	—
			400 kHz mode	100	—	ns	
			1 MHz mode ⁽¹⁾	100	—	ns	
IS26	THD:DAT	Data Input Hold Time	100 kHz mode	0	—	μs	—
			400 kHz mode	0	0.9	μs	
			1 MHz mode ⁽¹⁾	0	0.3	μs	
IS30	TSU:STA	Start Condition Setup Time	100 kHz mode	4.7	—	μs	Only relevant for Repeated Start condition
			400 kHz mode	0.6	—	μs	
			1 MHz mode ⁽¹⁾	0.25	—	μs	
IS31	THD:STA	Start Condition Hold Time	100 kHz mode	4.0	—	μs	After this period, the first clock pulse is generated
			400 kHz mode	0.6	—	μs	
			1 MHz mode ⁽¹⁾	0.25	—	μs	
IS33	TSU:STO	Stop Condition Setup Time	100 kHz mode	4.7	—	μs	—
			400 kHz mode	0.6	—	μs	
			1 MHz mode ⁽¹⁾	0.6	—	μs	
IS34	THD:STO	Stop Condition Hold Time	100 kHz mode	4000	—	ns	—
			400 kHz mode	600	—	ns	
			1 MHz mode ⁽¹⁾	250	—	ns	
IS40	TAA:SCL	Output Valid From Clock	100 kHz mode	0	3500	ns	—
			400 kHz mode	0	1000	ns	
			1 MHz mode ⁽¹⁾	0	350	ns	
IS45	TBF:SDA	Bus Free Time	100 kHz mode	4.7	—	μs	Time the bus must be free before a new transmission can start
			400 kHz mode	1.3	—	μs	
			1 MHz mode ⁽¹⁾	0.5	—	μs	
IS50	CB	Bus Capacitive Loading		—	400	pF	—

Note 1: Maximum pin capacitance = 10 pF for all I2Cx pins (for 1 MHz mode only).

FIGURE 28-21: ECAN™ MODULE I/O TIMING CHARACTERISTICS



TABLE 28-38: ECAN™ MODULE I/O TIMING REQUIREMENTS

AC CHARACTERISTICS			Standard Operating Conditions: 3.0V to 3.6V (unless otherwise stated) Operating temperature $-40^{\circ}\text{C} \leq T_A \leq +85^{\circ}\text{C}$ for Industrial $-40^{\circ}\text{C} \leq T_A \leq +125^{\circ}\text{C}$ for Extended				
Param No.	Symbol	Characteristic ⁽¹⁾	Min	Typ ⁽²⁾	Max	Units	Conditions
CA10	TioF	Port Output Fall Time	—	—	—	ns	See parameter D032
CA11	TioR	Port Output Rise Time	—	—	—	ns	See parameter D031
CA20	Tcwf	Pulse Width to Trigger CAN Wake-up Filter	120			ns	—

Note 1: These parameters are characterized but not tested in manufacturing.

2: Data in “Typ” column is at 3.3V, 25°C unless otherwise stated. Parameters are for design guidance only and are not tested.

PIC24HJ32GP302/304, PIC24HJ64GPX02/X04 AND PIC24HJ128GPX02/X04

TABLE 28-39: ADC MODULE SPECIFICATIONS

AC CHARACTERISTICS			Standard Operating Conditions: 3.0V to 3.6V (unless otherwise stated) Operating temperature -40°C ≤ TA ≤ +85°C for Industrial -40°C ≤ TA ≤ +125°C for Extended				
Param No.	Symbol	Characteristic	Min.	Typ	Max.	Units	Conditions
Device Supply							
AD01	AVDD	Module VDD Supply	Greater of VDD - 0.3 or 3.0	—	Lesser of VDD + 0.3 or 3.6	V	—
AD02	AVSS	Module VSS Supply	VSS - 0.3	—	VSS + 0.3	V	—
Reference Inputs							
AD05	VREFH	Reference Voltage High	AVSS + 2.5	—	AVDD	V	VREFH = AVDD VREFL = AVSS = 0
AD05a			3.0	—	3.6	V	
AD06	VREFL	Reference Voltage Low	AVSS	—	AVDD - 2.5	V	VREFH = AVDD VREFL = AVSS = 0
AD06a			0	—	0	V	
AD07	VREF	Absolute Reference Voltage	2.5	—	3.6	V	VREF = VREFH - VREFL
AD08	IREF	Current Drain	—	—	10	μA	ADC off
AD09	IAD	Operating Current	—	7.0	9.0	mA	ADC operating in 10-bit mode, see Note 1 ADC operating in 12-bit mode, see Note 1
			—	2.7	3.2	mA	
Analog Input							
AD12	VINH	Input Voltage Range VINH	VINL	—	VREFH	V	This voltage reflects Sample and Hold Channels 0, 1, 2, and 3 (CH0-CH3), positive input
AD13	VINL	Input Voltage Range VINL	VREFL	—	AVSS + 1V	V	This voltage reflects Sample and Hold Channels 0, 1, 2, and 3 (CH0-CH3), negative input
AD17	RIN	Recommended Impedance of Analog Voltage Source	—	—	200	Ω	10-bit ADC 12-bit ADC
			—	—	200	Ω	

Note 1: These parameters are not characterized or tested in manufacturing.

TABLE 28-40: ADC MODULE SPECIFICATIONS (12-BIT MODE)

AC CHARACTERISTICS			Standard Operating Conditions: 3.0V to 3.6V (unless otherwise stated) Operating temperature -40°C ≤ TA ≤ +85°C for Industrial -40°C ≤ TA ≤ +125°C for Extended				
Param No.	Symbol	Characteristic	Min.	Typ	Max.	Units	Conditions
ADC Accuracy (12-bit Mode) – Measurements with external VREF+/VREF-							
AD20a	Nr	Resolution ⁽¹⁾	12 data bits			bits	
AD21a	INL	Integral Nonlinearity	-2	—	+2	LSb	VINL = AVSS = VREFL = 0V, AVDD = VREFH = 3.6V
AD22a	DNL	Differential Nonlinearity	> -1	—	< 1	LSb	VINL = AVSS = VREFL = 0V, AVDD = VREFH = 3.6V
AD23a	GERR	Gain Error	—	3.4	10	LSb	VINL = AVSS = VREFL = 0V, AVDD = VREFH = 3.6V
AD24a	E _{OFF}	Offset Error	—	0.9	5	LSb	VINL = AVSS = VREFL = 0V, AVDD = VREFH = 3.6V
AD25a	—	Monotonicity	—	—	—	—	Guaranteed
ADC Accuracy (12-bit Mode) – Measurements with internal VREF+/VREF-							
AD20a	Nr	Resolution ⁽¹⁾	12 data bits			bits	
AD21a	INL	Integral Nonlinearity	-2	—	+2	LSb	VINL = AVSS = 0V, AVDD = 3.6V
AD22a	DNL	Differential Nonlinearity	> -1	—	< 1	LSb	VINL = AVSS = 0V, AVDD = 3.6V
AD23a	GERR	Gain Error	2	10.5	20	LSb	VINL = AVSS = 0V, AVDD = 3.6V
AD24a	E _{OFF}	Offset Error	2	3.8	10	LSb	VINL = AVSS = 0V, AVDD = 3.6V
AD25a	—	Monotonicity	—	—	—	—	Guaranteed
Dynamic Performance (12-bit Mode)							
AD30a	THD	Total Harmonic Distortion	—	—	-75	dB	—
AD31a	SINAD	Signal to Noise and Distortion	68.5	69.5	—	dB	—
AD32a	SFDR	Spurious Free Dynamic Range	80	—	—	dB	—
AD33a	F _{NYQ}	Input Signal Bandwidth	—	—	250	kHz	—
AD34a	ENOB	Effective Number of Bits	11.09	11.3	—	bits	—

Note 1: Injection currents > |0| can affect the ADC results by approximately 4 to 6 counts (i.e., V_{IH} source > (V_{DD} + 0.3V) or V_{IL} source < (V_{SS} - 0.3V).

TABLE 28-41: ADC MODULE SPECIFICATIONS (10-BIT MODE)

AC CHARACTERISTICS			Standard Operating Conditions: 3.0V to 3.6V (unless otherwise stated) Operating temperature -40°C ≤ TA ≤ +85°C for Industrial -40°C ≤ TA ≤ +125°C for Extended				
Param No.	Symbol	Characteristic	Min.	Typ	Max.	Units	Conditions
ADC Accuracy (10-bit Mode) – Measurements with external VREF+/VREF-							
AD20b	Nr	Resolution ⁽¹⁾	10 data bits			bits	
AD21b	INL	Integral Nonlinearity	-1.5	—	+1.5	LSb	VINL = AVSS = VREFL = 0V, AVDD = VREFH = 3.6V
AD22b	DNL	Differential Nonlinearity	> -1	—	< 1	LSb	VINL = AVSS = VREFL = 0V, AVDD = VREFH = 3.6V
AD23b	GERR	Gain Error	—	3	6	LSb	VINL = AVSS = VREFL = 0V, AVDD = VREFH = 3.6V
AD24b	E _{OFF}	Offset Error	—	2	5	LSb	VINL = AVSS = VREFL = 0V, AVDD = VREFH = 3.6V
AD25b	—	Monotonicity	—	—	—	—	Guaranteed
ADC Accuracy (10-bit Mode) – Measurements with internal VREF+/VREF-							
AD20b	Nr	Resolution ⁽¹⁾	10 data bits			bits	
AD21b	INL	Integral Nonlinearity	-1	—	+1	LSb	VINL = AVSS = 0V, AVDD = 3.6V
AD22b	DNL	Differential Nonlinearity	> -1	—	< 1	LSb	VINL = AVSS = 0V, AVDD = 3.6V
AD23b	GERR	Gain Error	3	7	15	LSb	VINL = AVSS = 0V, AVDD = 3.6V
AD24b	E _{OFF}	Offset Error	1.5	3	7	LSb	VINL = AVSS = 0V, AVDD = 3.6V
AD25b	—	Monotonicity	—	—	—	—	Guaranteed
Dynamic Performance (10-bit Mode)							
AD30b	THD	Total Harmonic Distortion	—	—	-64	dB	—
AD31b	SINAD	Signal to Noise and Distortion	57	58.5	—	dB	—
AD32b	SFDR	Spurious Free Dynamic Range	72	—	—	dB	—
AD33b	F _{NYQ}	Input Signal Bandwidth	—	—	550	kHz	—
AD34b	ENOB	Effective Number of Bits	9.16	9.4	—	bits	—

Note 1: Injection currents > |0| can affect the ADC results by approximately 4-6 counts.

FIGURE 28-22: ADC CONVERSION (12-BIT MODE) TIMING CHARACTERISTICS
(ASAM = 0, SSRC<2:0> = 000)



TABLE 28-42: ADC CONVERSION (12-BIT MODE) TIMING REQUIREMENTS

AC CHARACTERISTICS			Standard Operating Conditions: 3.0V to 3.6V (unless otherwise stated) Operating temperature -40°C ≤ TA ≤ +85°C for Industrial -40°C ≤ TA ≤ +125°C for Extended				
Param No.	Symbol	Characteristic	Min.	Typ ⁽²⁾	Max.	Units	Conditions
Clock Parameters⁽¹⁾							
AD50	TAD	ADC Clock Period	117.6	—	—	ns	—
AD51	tRC	ADC Internal RC Oscillator Period	—	250	—	ns	—
Conversion Rate							
AD55	tCONV	Conversion Time	—	14 TAD	—	ns	—
AD56	FCNV	Throughput Rate	—	—	500	Ksps	—
AD57	TSAMP	Sample Time	3 TAD	—	—	—	—
Timing Parameters							
AD60	tPCS	Conversion Start from Sample Trigger ⁽²⁾	2 TAD	—	3 TAD	—	Auto convert trigger not selected
AD61	tPSS	Sample Start from Setting Sample (SAMP) bit ⁽²⁾	2 TAD	—	3 TAD	—	—
AD62	tCSS	Conversion Completion to Sample Start (ASAM = 1) ⁽²⁾	—	0.5 TAD	—	—	—
AD63	tDPU	Time to Stabilize Analog Stage from ADC Off to ADC On ^(2,3)	—	—	20	μs	—

Note 1: Because the sample caps eventually loses charge, clock rates below 10 kHz may affect linearity performance, especially at elevated temperatures.

2: These parameters are characterized but not tested in manufacturing.

3: The tDPU is the time required for the ADC module to stabilize at the appropriate level when the module is turned on (ADxCON1<ADON>='1'). During this time, the ADC result is indeterminate.

FIGURE 28-23: ADC CONVERSION (10-BIT MODE) TIMING CHARACTERISTICS (CHPS<1:0> = 01, SIMSAM = 0, ASAM = 0, SSRC<2:0> = 000)



FIGURE 28-24: ADC CONVERSION (10-BIT MODE) TIMING CHARACTERISTICS (CHPS<1:0> = 01, SIMSAM = 0, ASAM = 1, SSRC<2:0> = 111, SAMC<4:0> = 00001)



TABLE 28-43: ADC CONVERSION (10-BIT MODE) TIMING REQUIREMENTS

AC CHARACTERISTICS			Standard Operating Conditions: 3.0V to 3.6V (unless otherwise stated) Operating temperature -40°C ≤ TA ≤ +85°C for Industrial -40°C ≤ TA ≤ +125°C for Extended				
Param No.	Symbol	Characteristic	Min.	Typ ⁽¹⁾	Max.	Units	Conditions
Clock Parameters							
AD50	TAD	ADC Clock Period	76	—	—	ns	—
AD51	tRC	ADC Internal RC Oscillator Period	—	250	—	ns	—
Conversion Rate							
AD55	tCONV	Conversion Time	—	12 TAD	—	—	—
AD56	FCNV	Throughput Rate	—	—	1.1	Msp/s	—
AD57	TSAMP	Sample Time	2 TAD	—	—	—	—
Timing Parameters							
AD60	tPCS	Conversion Start from Sample Trigger ⁽¹⁾	2 TAD	—	3 TAD	—	Auto-Convert Trigger not selected
AD61	tPSS	Sample Start from Setting Sample (SAMP) bit ⁽¹⁾	2 TAD	—	3 TAD	—	—
AD62	tCSS	Conversion Completion to Sample Start (ASAM = 1) ⁽¹⁾	—	0.5 TAD	—	—	—
AD63	tDPU	Time to Stabilize Analog Stage from ADC Off to ADC On ^(1,3)	—	—	20	μs	—

- Note 1:** These parameters are characterized but not tested in manufacturing.
- Note 2:** Because the sample caps eventually loses charge, clock rates below 10 kHz may affect linearity performance, especially at elevated temperatures.
- Note 3:** The tDPU is the time required for the ADC module to stabilize at the appropriate level when the module is turned on (ADxCON1<ADON>='1'). During this time, the ADC result is indeterminate.

TABLE 28-44: COMPARATOR TIMING SPECIFICATIONS

AC CHARACTERISTICS			Standard Operating Conditions: 3.0V to 3.6V (unless otherwise stated) Operating temperature -40°C ≤ TA ≤ +85°C for Industrial -40°C ≤ TA ≤ +125°C for Extended				
Param No.	Symbol	Characteristic	Min.	Typ	Max.	Units	Conditions
300	TRESP	Response Time ^(1,2)	—	150	400	ns	—
301	TMC2OV	Comparator Mode Change to Output Valid ⁽¹⁾	—	—	10	μs	—

- Note 1:** Parameters are characterized but not tested.
- Note 2:** Response time measured with one comparator input at (VDD - 1.5)/2, while the other input transitions from VSS to VDD.

TABLE 28-45: COMPARATOR MODULE SPECIFICATIONS

DC CHARACTERISTICS			Standard Operating Conditions: 3.0V to 3.6V (unless otherwise stated) Operating temperature -40°C ≤ TA ≤ +85°C for Industrial -40°C ≤ TA ≤ +125°C for Extended				
Param No.	Symbol	Characteristic	Min.	Typ	Max.	Units	Conditions
D300	VIOFF	Input Offset Voltage ⁽¹⁾	—	±10	—	mV	—
D301	VICM	Input Common Mode Voltage ⁽¹⁾	0	—	AVDD-1.5V	V	—
D302	CMRR	Common Mode Rejection Ratio ⁽¹⁾	-54	—	—	dB	—

Note 1: Parameters are characterized but not tested.

TABLE 28-46: COMPARATOR REFERENCE VOLTAGE SETTling TIME SPECIFICATIONS

AC CHARACTERISTICS			Standard Operating Conditions: 3.0V to 3.6V (unless otherwise stated) Operating temperature -40°C ≤ TA ≤ +85°C for Industrial -40°C ≤ TA ≤ +125°C for Extended				
Param No.	Symbol	Characteristic	Min.	Typ	Max.	Units	Conditions
VR310	TSET	Settling Time ⁽¹⁾	—	—	10	µs	—

Note 1: Setting time measured while CVRR = 1 and CVR3:CVR0 bits transition from '0000' to '1111'.

TABLE 28-47: COMPARATOR REFERENCE VOLTAGE SPECIFICATIONS

DC CHARACTERISTICS			Standard Operating Conditions: 3.0V to 3.6V (unless otherwise stated) Operating temperature -40°C ≤ TA ≤ +85°C for Industrial -40°C ≤ TA ≤ +125°C for Extended				
Param No.	Symbol	Characteristic	Min.	Typ	Max.	Units	Conditions
VRD310	CVRES	Resolution	CVRSRC/24	—	CVRSRC/32	LSb	—
VRD311	CVRAA	Absolute Accuracy	—	—	0.5	LSb	—
VRD312	CVRUR	Unit Resistor Value (R)	—	2k	—	Ω	—

FIGURE 28-25: PARALLEL SLAVE PORT TIMING DIAGRAM



TABLE 28-48: SETTING TIME SPECIFICATIONS

AC CHARACTERISTICS			Standard Operating Conditions: 3.0V to 3.6V (unless otherwise stated) Operating temperature $-40^{\circ}\text{C} \leq T_A \leq +85^{\circ}\text{C}$ for Industrial $-40^{\circ}\text{C} \leq T_A \leq +125^{\circ}\text{C}$ for Extended				
Param No.	Symbol	Characteristic	Min.	Typ	Max.	Units	Conditions
PS1	TdtV2wrH	Data in Valid before \overline{WR} or \overline{CS} Inactive (setup time)	20	—	—	ns	—
PS2	TwrH2dtI	\overline{WR} or \overline{CS} Inactive to Data-In Invalid (hold time)	20	—	—	ns	—
PS3	TrdL2dtV	\overline{RD} and \overline{CS} to Active Data-Out Valid	—	—	80	ns	—
PS4	TrdH2dtI	\overline{RD} Active or \overline{CS} Inactive to Data-Out Invalid	10	—	30	ns	—

FIGURE 28-26: PARALLEL MASTER PORT READ TIMING DIAGRAM



TABLE 28-49: PARALLEL MASTER PORT READ TIMING REQUIREMENTS

AC CHARACTERISTICS		Standard Operating Conditions: 3.0V to 3.6V (unless otherwise stated) Operating temperature -40°C ≤ TA ≤ +85°C for Industrial -40°C ≤ TA ≤ +125°C for Extended				
Param No.	Characteristic	Min.	Typ	Max.	Units	Conditions
PM1	PMALL/PMALH Pulse Width	—	0.5 T _{CY}	—	ns	—
PM2	Address Out Valid to PMALL/PMALH Invalid (address setup time)	—	0.75 T _{CY}	—	ns	—
PM3	PMALL/PMALH Invalid to Address Out Invalid (address hold time)	—	0.25 T _{CY}	—	ns	—
PM5	PMRD Pulse Width	—	0.5 T _{CY}	—	ns	—
PM6	PMRD or PMENB Active to Data In Valid (data setup time)	150	—	—	ns	—
PM7	PMRD or PMENB Inactive to Data In Invalid (data hold time)	—	—	5	ns	—

FIGURE 28-27: PARALLEL MASTER PORT WRITE TIMING DIAGRAM



TABLE 28-50: PARALLEL MASTER PORT WRITE TIMING REQUIREMENTS

AC CHARACTERISTICS		Standard Operating Conditions: 3.0V to 3.6V (unless otherwise stated) Operating temperature -40°C ≤ TA ≤ +85°C for Industrial -40°C ≤ TA ≤ +125°C for Extended				
Param No.	Characteristic	Min.	Typ	Max.	Units	Conditions
PM11	PMWR Pulse Width	—	0.5 T _{CY}	—	ns	—
PM12	Data Out Valid before PMWR or PMENB goes Inactive (data setup time)	—	—	—	ns	—
PM13	PMWR or PMEMB Invalid to Data Out Invalid (data hold time)	—	—	—	ns	—
PM16	PMCSx Pulse Width	T _{CY} - 5	—	—	ns	—

TABLE 28-51: DMA READ/WRITE TIMING REQUIREMENTS

AC CHARACTERISTICS		Standard Operating Conditions: 3.0V to 3.6V (unless otherwise stated) Operating temperature -40°C ≤ TA ≤ +85°C for Industrial -40°C ≤ TA ≤ +125°C for Extended				
Param No.	Characteristic	Min.	Typ	Max.	Units	Conditions
DM1	DMA Read/Write Cycle Time	—	—	1 T _{CY}	ns	—

29.0 HIGH TEMPERATURE ELECTRICAL CHARACTERISTICS

This section provides an overview of PIC24HJ32GP302/304, PIC24HJ64GPX02/X04 and PIC24HJ128GPX02/X04 electrical characteristics for devices operating in an ambient temperature range of -40°C to +150°C.

The specifications between -40°C to +150°C are identical to those shown in [Section 28.0 “Electrical Characteristics”](#) for operation between -40°C to +125°C, with the exception of the parameters listed in this section.

Parameters in this section begin with an H, which denotes High temperature. For example, parameter DC10 in [Section 28.0 “Electrical Characteristics”](#) is the Industrial and Extended temperature equivalent of HDC10.

Absolute maximum ratings for the PIC24HJ32GP302/304, PIC24HJ64GPX02/X04 and PIC24HJ128GPX02/X04 high temperature devices are listed below. Exposure to these maximum rating conditions for extended periods can affect device reliability. Functional operation of the device at these or any other conditions above the parameters indicated in the operation listings of this specification is not implied.

Absolute Maximum Ratings⁽¹⁾

Ambient temperature under bias ⁽⁴⁾	-40°C to +150°C
Storage temperature	-65°C to +160°C
Voltage on VDD with respect to VSS	-0.3V to +4.0V
Voltage on any pin that is not 5V tolerant with respect to VSS ⁽⁵⁾	-0.3V to (VDD + 0.3V)
Voltage on any 5V tolerant pin with respect to VSS when VDD < 3.0V ⁽⁵⁾	-0.3V to (VDD + 0.3V)
Voltage on any 5V tolerant pin with respect to VSS when VDD ≥ 3.0V ⁽⁵⁾	-0.3V to 5.6V
Maximum current out of VSS pin	60 mA
Maximum current into VDD pin ⁽²⁾	60 mA
Maximum junction temperature	+155°C
Maximum current sourced/sunk by any 2x I/O pin ⁽³⁾	2 mA
Maximum current sourced/sunk by any 4x I/O pin ⁽³⁾	4 mA
Maximum current sourced/sunk by any 8x I/O pin ⁽³⁾	8 mA
Maximum current sunk by all ports combined	70 mA
Maximum current sourced by all ports combined ⁽²⁾	70 mA

Note 1: Stresses above those listed under “Absolute Maximum Ratings” can cause permanent damage to the device. This is a stress rating only, and functional operation of the device at those or any other conditions above those indicated in the operation listings of this specification is not implied. Exposure to maximum rating conditions for extended periods can affect device reliability.

2: Maximum allowable current is a function of device maximum power dissipation (see [Table 29-2](#)).

3: Unlike devices at 125°C and below, the specifications in this section also apply to the CLKOUT, VREF+, VREF-, SCLx, SDAx, PGCx and PGDx pins.

4: AEC-Q100 reliability testing for devices intended to operate at 150°C is 1,000 hours. Any design in which the total operating time from 125°C to 150°C will be greater than 1,000 hours is not warranted without prior written approval from Microchip Technology Inc.

5: Refer to the “[Pin Diagrams](#)” section for 5V tolerant pins.

29.1 High Temperature DC Characteristics

TABLE 29-1: OPERATING MIPS VS. VOLTAGE

Characteristic	VDD Range (in Volts)	Temperature Range (in °C)	Max MIPS
			PIC24HJ32GP302/304, PIC24HJ64GPX02/X04 and PIC24HJ128GPX02/X04
—	3.0V to 3.6V ⁽¹⁾	-40°C to +150°C	20

Note 1: Device is functional at $V_{BORMIN} < V_{DD} < V_{DDMIN}$. Analog modules such as the ADC will have degraded performance. Device functionality is tested but not characterized.

TABLE 29-2: THERMAL OPERATING CONDITIONS

Rating	Symbol	Min	Typ	Max	Unit
High Temperature Devices					
Operating Junction Temperature Range	TJ	-40	—	+155	°C
Operating Ambient Temperature Range	TA	-40	—	+150	°C
Power Dissipation: Internal chip power dissipation: $P_{INT} = V_{DD} \times (I_{DD} - \Sigma I_{OH})$ I/O Pin Power Dissipation: $I/O = \Sigma (\{V_{DD} - V_{OH}\} \times I_{OH}) + \Sigma (V_{OL} \times I_{OL})$	PD	PINT + PI/O			W
Maximum Allowed Power Dissipation	PDMAX	$(T_J - T_A) / \theta_{JA}$			W

TABLE 29-3: DC TEMPERATURE AND VOLTAGE SPECIFICATIONS

DC CHARACTERISTICS			Standard Operating Conditions: 3.0V to 3.6V (unless otherwise stated) Operating temperature $-40^\circ\text{C} \leq T_A \leq +150^\circ\text{C}$ for High Temperature				
Parameter No.	Symbol	Characteristic	Min	Typ	Max	Units	Conditions
Operating Voltage							
HDC10	Supply Voltage						
	VDD	—	3.0	3.3	3.6	V	-40°C to +140°C

Note 1: Device is functional at $V_{BORMIN} < V_{DD} < V_{DDMIN}$. Analog modules such as the ADC will have degraded performance. Device functionality is tested but not characterized.

TABLE 29-4: DC CHARACTERISTICS: POWER-DOWN CURRENT (IPD)

DC CHARACTERISTICS			Standard Operating Conditions: 3.0V to 3.6V (unless otherwise stated) Operating temperature $-40^{\circ}\text{C} \leq T_A \leq +150^{\circ}\text{C}$ for High Temperature			
Parameter No.	Typical	Max	Units	Conditions		
Power-Down Current (IPD)						
HDC60e	250	2000	μA	+150°C	3.3V	Base Power-Down Current ^(1,3)
HDC61c	3	5	μA	+150°C	3.3V	Watchdog Timer Current: ΔI_{WDT} ^(2,4)

- Note 1:** Base IPD is measured with all peripherals and clocks shut down. All I/Os are configured as inputs and pulled to Vss. WDT, etc., are all switched off, and VREGS (RCON<8>) = 1.
- Note 2:** The Δ current is the additional current consumed when the module is enabled. This current should be added to the base IPD current.
- Note 3:** These currents are measured on the device containing the most memory in this family.
- Note 4:** These parameters are characterized, but are not tested in manufacturing.

TABLE 29-5: DC CHARACTERISTICS: DOZE CURRENT (IDOZE)

DC CHARACTERISTICS			Standard Operating Conditions: 3.0V to 3.6V (unless otherwise stated) Operating temperature $-40^{\circ}\text{C} \leq T_A \leq +150^{\circ}\text{C}$ for High Temperature			
Parameter No.	Typical ⁽¹⁾	Max	Doze Ratio	Units	Conditions	
HDC72a	39	45	1:2	mA	+150°C	3.3V
HDC72f	18	25	1:64	mA		
HDC72g	18	25	1:128	mA		

- Note 1:** Parameters with Doze ratios of 1:2 and 1:64 are characterized, but are not tested in manufacturing.

PIC24HJ32GP302/304, PIC24HJ64GPX02/X04 AND PIC24HJ128GPX02/X04

TABLE 29-6: DC CHARACTERISTICS: I/O PIN OUTPUT SPECIFICATIONS

DC CHARACTERISTICS			Standard Operating Conditions: 3.0V to 3.6V (unless otherwise stated) Operating temperature $-40^{\circ}\text{C} \leq T_A \leq +150^{\circ}\text{C}$ for High Temperature				
Param.	Symbol	Characteristic	Min.	Typ.	Max.	Units	Conditions
DO10	VOL	Output Low Voltage I/O Pins: 2x Sink Driver Pins - RA2, RA7-RA10, RB10, RB11, RB7, RB4, RC3-RC9	—	—	0.4	V	$I_{OL} \leq 1.8 \text{ mA}$, $V_{DD} = 3.3\text{V}$ See Note 1
		Output Low Voltage I/O Pins: 4x Sink Driver Pins - RA0, RA1, RB0-RB3, RB5, RB6, RB8, RB9, RB12-RB15, RC0-RC2	—	—	0.4	V	$I_{OL} \leq 3.6 \text{ mA}$, $V_{DD} = 3.3\text{V}$ See Note 1
		Output Low Voltage I/O Pins: 8x Sink Driver Pins - RA3, RA4	—	—	0.4	V	$I_{OL} \leq 6 \text{ mA}$, $V_{DD} = 3.3\text{V}$ See Note 1
DO20	VOH	Output High Voltage I/O Pins: 2x Source Driver Pins - RA2, RA7-RA10, RB4, RB7, RB10, RB11, RC3-RC9	2.4	—	—	V	$I_{OL} \geq -1.8 \text{ mA}$, $V_{DD} = 3.3\text{V}$ See Note 1
		Output High Voltage I/O Pins: 4x Source Driver Pins - RA0, RA1, RB0-RB3, RB5, RB6, RB8, RB9, RB12-RB15, RC0-RC2	2.4	—	—	V	$I_{OL} \geq -3 \text{ mA}$, $V_{DD} = 3.3\text{V}$ See Note 1
		Output High Voltage I/O Pins: 8x Source Driver Pins - RA4, RA3	2.4	—	—	V	$I_{OL} \geq -6 \text{ mA}$, $V_{DD} = 3.3\text{V}$ See Note 1
DO20A	VOH1	Output High Voltage I/O Pins: 2x Source Driver Pins - RA2, RA7-RA10, RB4, RB7, RB10, RB11, RC3-RC9	1.5	—	—	V	$I_{OH} \geq -1.9 \text{ mA}$, $V_{DD} = 3.3\text{V}$ See Note 1
			2.0	—	—		$I_{OH} \geq -1.85 \text{ mA}$, $V_{DD} = 3.3\text{V}$ See Note 1
			3.0	—	—		$I_{OH} \geq -1.4 \text{ mA}$, $V_{DD} = 3.3\text{V}$ See Note 1
		Output High Voltage 4x Source Driver Pins - RA0, RA1, RB0-RB3, RB5, RB6, RB8, RB9, RB12-RB15, RC0-RC2	1.5	—	—	V	$I_{OH} \geq -3.9 \text{ mA}$, $V_{DD} = 3.3\text{V}$ See Note 1
			2.0	—	—		$I_{OH} \geq -3.7 \text{ mA}$, $V_{DD} = 3.3\text{V}$ See Note 1
			3.0	—	—		$I_{OH} \geq -2 \text{ mA}$, $V_{DD} = 3.3\text{V}$ See Note 1
		Output High Voltage I/O Pins: 8x Source Driver Pins - RA3, RA4	1.5	—	—	V	$I_{OH} \geq -7.5 \text{ mA}$, $V_{DD} = 3.3\text{V}$ See Note 1
			2.0	—	—		$I_{OH} \geq -6.8 \text{ mA}$, $V_{DD} = 3.3\text{V}$ See Note 1
			3.0	—	—		$I_{OH} \geq -3 \text{ mA}$, $V_{DD} = 3.3\text{V}$ See Note 1

Note 1: Parameters are characterized, but not tested.

TABLE 29-7: DC CHARACTERISTICS: PROGRAM MEMORY

DC CHARACTERISTICS			Standard Operating Conditions: 3.0V to 3.6V (unless otherwise stated) Operating temperature $-40^{\circ}\text{C} \leq T_A \leq +150^{\circ}\text{C}$ for High Temperature				
Param No.	Symbol	Characteristic ⁽¹⁾	Min	Typ	Max	Units	Conditions
		Program Flash Memory					
HD130	EP	Cell Endurance	10,000	—	—	E/W	-40° C to +150° C ⁽²⁾ 1000 E/W cycles or less and no other specifications are violated
HD134	TRETD	Characteristic Retention	20	—	—	Year	

Note 1: These parameters are assured by design, but are not characterized or tested in manufacturing.

2: Programming of the Flash memory is allowed up to 150°C.

29.2 AC Characteristics and Timing Parameters

The information contained in this section defines PIC24HJ32GP302/304, PIC24HJ64GPX02/X04 and PIC24HJ128GPX02/X04 AC characteristics and timing parameters for high temperature devices. However, all AC timing specifications in this section are the same as those in [Section 28.2 “AC Characteristics and Timing Parameters”](#), with the exception of the parameters listed in this section.

Parameters in this section begin with an H, which denotes High temperature. For example, parameter OS53 in [Section 28.2 “AC Characteristics and Timing Parameters”](#) is the Industrial and Extended temperature equivalent of HOS53.

TABLE 29-8: TEMPERATURE AND VOLTAGE SPECIFICATIONS – AC

AC CHARACTERISTICS	Standard Operating Conditions: 3.0V to 3.6V (unless otherwise stated) Operating temperature $-40^{\circ}\text{C} \leq T_A \leq +150^{\circ}\text{C}$ for High Temperature Operating voltage V_{DD} range as described in Table 29-1 .
---------------------------	--

FIGURE 29-1: LOAD CONDITIONS FOR DEVICE TIMING SPECIFICATIONS



TABLE 29-9: PLL CLOCK TIMING SPECIFICATIONS

AC CHARACTERISTICS		Standard Operating Conditions: 3.0V to 3.6V (unless otherwise stated) Operating temperature $-40^{\circ}\text{C} \leq T_A \leq +150^{\circ}\text{C}$ for High Temperature					
Param No.	Symbol	Characteristic	Min	Typ	Max	Units	Conditions
HOS53	DCLK	CLKO Stability (Jitter) ⁽¹⁾	-5	0.5	5	%	Measured over 100 ms period

Note 1: These parameters are characterized, but are not tested in manufacturing.

TABLE 29-10: SPIx MASTER MODE (CKE = 0) TIMING REQUIREMENTS

AC CHARACTERISTICS		Standard Operating Conditions: 3.0V to 3.6V (unless otherwise stated) Operating temperature $-40^{\circ}\text{C} \leq T_A \leq +150^{\circ}\text{C}$ for High Temperature					
Param No.	Symbol	Characteristic ⁽¹⁾	Min	Typ	Max	Units	Conditions
HSP35	Tsch2doV, TscL2doV	SDOx Data Output Valid after SCKx Edge	—	10	25	ns	—
HSP40	TdiV2sch, TdiV2scL	Setup Time of SDIx Data Input to SCKx Edge	28	—	—	ns	—
HSP41	Tsch2diL, TscL2diL	Hold Time of SDIx Data Input to SCKx Edge	35	—	—	ns	—

Note 1: These parameters are characterized but not tested in manufacturing.

TABLE 29-11: SPIx MODULE MASTER MODE (CKE = 1) TIMING REQUIREMENTS

AC CHARACTERISTICS		Standard Operating Conditions: 3.0V to 3.6V (unless otherwise stated) Operating temperature $-40^{\circ}\text{C} \leq T_A \leq +150^{\circ}\text{C}$ for High Temperature					
Param No.	Symbol	Characteristic ⁽¹⁾	Min	Typ	Max	Units	Conditions
HSP35	Tsch2doV, TscL2doV	SDOx Data Output Valid after SCKx Edge	—	10	25	ns	—
HSP36	TdoV2sc, TdoV2scL	SDOx Data Output Setup to First SCKx Edge	35	—	—	ns	—
HSP40	TdiV2sch, TdiV2scL	Setup Time of SDIx Data Input to SCKx Edge	28	—	—	ns	—
HSP41	Tsch2diL, TscL2diL	Hold Time of SDIx Data Input to SCKx Edge	35	—	—	ns	—

Note 1: These parameters are characterized but not tested in manufacturing.

TABLE 29-12: SPIx MODULE SLAVE MODE (CKE = 0) TIMING REQUIREMENTS

AC CHARACTERISTICS		Standard Operating Conditions: 3.0V to 3.6V (unless otherwise stated) Operating temperature $-40^{\circ}\text{C} \leq T_A \leq +150^{\circ}\text{C}$ for High Temperature					
Param No.	Symbol	Characteristic ⁽¹⁾	Min	Typ	Max	Units	Conditions
HSP35	Tsch2doV, TscL2doV	SDOx Data Output Valid after SCKx Edge	—	—	35	ns	—
HSP40	TdiV2sch, TdiV2scL	Setup Time of SDIx Data Input to SCKx Edge	25	—	—	ns	—
HSP41	Tsch2diL, TscL2diL	Hold Time of SDIx Data Input to SCKx Edge	25	—	—	ns	—
HSP51	TssH2doZ	$\overline{\text{SSx}}$ \uparrow to SDOx Output High-Impedance	15	—	55	ns	See Note 2

Note 1: These parameters are characterized but not tested in manufacturing.

2: Assumes 50 pF load on all SPIx pins.

TABLE 29-13: SPIx MODULE SLAVE MODE (CKE = 1) TIMING REQUIREMENTS

AC CHARACTERISTICS		Standard Operating Conditions: 3.0V to 3.6V (unless otherwise stated) Operating temperature $-40^{\circ}\text{C} \leq T_A \leq +150^{\circ}\text{C}$ for High Temperature					
Param No.	Symbol	Characteristic ⁽¹⁾	Min	Typ	Max	Units	Conditions
HSP35	Tsch2doV, TscL2doV	SDOx Data Output Valid after SCKx Edge	—	—	35	ns	—
HSP40	TdiV2sch, TdiV2scL	Setup Time of SDIx Data Input to SCKx Edge	25	—	—	ns	—
HSP41	Tsch2diL, TscL2diL	Hold Time of SDIx Data Input to SCKx Edge	25	—	—	ns	—
HSP51	TssH2doZ	$\overline{\text{SSx}}$ \uparrow to SDOx Output High-Impedance	15	—	55	ns	See Note 2
HSP60	TssL2doV	SDOx Data Output Valid after $\overline{\text{SSx}}$ Edge	—	—	55	ns	—

Note 1: These parameters are characterized but not tested in manufacturing.

2: Assumes 50 pF load on all SPIx pins.

TABLE 29-14: ADC MODULE SPECIFICATIONS

AC CHARACTERISTICS		Standard Operating Conditions: 3.0V to 3.6V (unless otherwise stated) Operating temperature $-40^{\circ}\text{C} \leq T_A \leq +150^{\circ}\text{C}$ for High Temperature					
Param No.	Symbol	Characteristic	Min	Typ	Max	Units	Conditions
Reference Inputs							
HAD08	IREF	Current Drain	—	250	600	μA	ADC operating, See Note 1
			—	—	50	μA	ADC off, See Note 1

- Note 1:** These parameters are not characterized or tested in manufacturing.
Note 2: These parameters are characterized, but are not tested in manufacturing.

TABLE 29-15: ADC MODULE SPECIFICATIONS (12-BIT MODE)

AC CHARACTERISTICS		Standard Operating Conditions: 3.0V to 3.6V (unless otherwise stated) Operating temperature $-40^{\circ}\text{C} \leq T_A \leq +150^{\circ}\text{C}$ for High Temperature					
Param No.	Symbol	Characteristic	Min	Typ	Max	Units	Conditions
ADC Accuracy (12-bit Mode) – Measurements with External VREF+/VREF-(¹)							
HAD20a	Nr	Resolution(³)	12 data bits			bits	—
HAD21a	INL	Integral Nonlinearity	-2	—	+2	LSb	V _{INL} = AV _{SS} = V _{REFL} = 0V, AV _{DD} = V _{REFH} = 3.6V
HAD22a	DNL	Differential Nonlinearity	> -1	—	< 1	LSb	V _{INL} = AV _{SS} = V _{REFL} = 0V, AV _{DD} = V _{REFH} = 3.6V
HAD23a	GERR	Gain Error	-2	—	10	LSb	V _{INL} = AV _{SS} = V _{REFL} = 0V, AV _{DD} = V _{REFH} = 3.6V
HAD24a	E _{OFF}	Offset Error	-3	—	5	LSb	V _{INL} = AV _{SS} = V _{REFL} = 0V, AV _{DD} = V _{REFH} = 3.6V
ADC Accuracy (12-bit Mode) – Measurements with Internal VREF+/VREF-(¹)							
HAD20a	Nr	Resolution(³)	12 data bits			bits	—
HAD21a	INL	Integral Nonlinearity	-2	—	+2	LSb	V _{INL} = AV _{SS} = 0V, AV _{DD} = 3.6V
HAD22a	DNL	Differential Nonlinearity	> -1	—	< 1	LSb	V _{INL} = AV _{SS} = 0V, AV _{DD} = 3.6V
HAD23a	GERR	Gain Error	2	—	20	LSb	V _{INL} = AV _{SS} = 0V, AV _{DD} = 3.6V
HAD24a	E _{OFF}	Offset Error	2	—	10	LSb	V _{INL} = AV _{SS} = 0V, AV _{DD} = 3.6V
Dynamic Performance (12-bit Mode)(²)							
HAD33a	F _{NYQ}	Input Signal Bandwidth	—	—	200	kHz	—

- Note 1:** These parameters are characterized, but are tested at 20 kps only.
Note 2: These parameters are characterized by similarity, but are not tested in manufacturing.
Note 3: Injection currents $> |0|$ can affect the ADC results by approximately 4-6 counts.

PIC24HJ32GP302/304, PIC24HJ64GPX02/X04 AND PIC24HJ128GPX02/X04

TABLE 29-16: ADC MODULE SPECIFICATIONS (10-BIT MODE)

AC CHARACTERISTICS		Standard Operating Conditions: 3.0V to 3.6V (unless otherwise stated) Operating temperature $-40^{\circ}\text{C} \leq T_A \leq 150^{\circ}\text{C}$ for High Temperature					
Param No.	Symbol	Characteristic	Min	Typ	Max	Units	Conditions
ADC Accuracy (10-bit Mode) – Measurements with External VREF+/VREF-⁽¹⁾							
HAD20b	Nr	Resolution ⁽³⁾	10 data bits			bits	—
HAD21b	INL	Integral Nonlinearity	-3	—	3	LSb	V _{INL} = AV _{SS} = V _{REFL} = 0V, AV _{DD} = V _{REFH} = 3.6V
HAD22b	DNL	Differential Nonlinearity	> -1	—	< 1	LSb	V _{INL} = AV _{SS} = V _{REFL} = 0V, AV _{DD} = V _{REFH} = 3.6V
HAD23b	GERR	Gain Error	-5	—	6	LSb	V _{INL} = AV _{SS} = V _{REFL} = 0V, AV _{DD} = V _{REFH} = 3.6V
HAD24b	E _{OFF}	Offset Error	-1	—	5	LSb	V _{INL} = AV _{SS} = V _{REFL} = 0V, AV _{DD} = V _{REFH} = 3.6V
ADC Accuracy (10-bit Mode) – Measurements with Internal VREF+/VREF-⁽¹⁾							
HAD20b	Nr	Resolution ⁽³⁾	10 data bits			bits	—
HAD21b	INL	Integral Nonlinearity	-2	—	2	LSb	V _{INL} = AV _{SS} = 0V, AV _{DD} = 3.6V
HAD22b	DNL	Differential Nonlinearity	> -1	—	< 1	LSb	V _{INL} = AV _{SS} = 0V, AV _{DD} = 3.6V
HAD23b	GERR	Gain Error	-5	—	15	LSb	V _{INL} = AV _{SS} = 0V, AV _{DD} = 3.6V
HAD24b	E _{OFF}	Offset Error	-1.5	—	7	LSb	V _{INL} = AV _{SS} = 0V, AV _{DD} = 3.6V
Dynamic Performance (10-bit Mode)⁽²⁾							
HAD33b	F _{NYQ}	Input Signal Bandwidth	—	—	400	kHz	—

- Note 1:** These parameters are characterized, but are tested at 20 ksp/s only.
Note 2: These parameters are characterized by similarity, but are not tested in manufacturing.
Note 3: Injection currents $> |0|$ can affect the ADC results by approximately 4-6 counts.

TABLE 29-17: ADC CONVERSION (12-BIT MODE) TIMING REQUIREMENTS

AC CHARACTERISTICS		Standard Operating Conditions: 3.0V to 3.6V (unless otherwise stated) Operating temperature $-40^{\circ}\text{C} \leq T_A \leq +150^{\circ}\text{C}$ for High Temperature					
Param No.	Symbol	Characteristic	Min	Typ	Max	Units	Conditions
Clock Parameters							
HAD50	TAD	ADC Clock Period ⁽¹⁾	147	—	—	ns	—
Conversion Rate							
HAD56	FCNV	Throughput Rate ⁽¹⁾	—	—	400	Ksps	—

Note 1: These parameters are characterized but not tested in manufacturing.

TABLE 29-18: ADC CONVERSION (10-BIT MODE) TIMING REQUIREMENTS

AC CHARACTERISTICS		Standard Operating Conditions: 3.0V to 3.6V (unless otherwise stated) Operating temperature $-40^{\circ}\text{C} \leq T_A \leq +150^{\circ}\text{C}$ for High Temperature					
Param No.	Symbol	Characteristic	Min	Typ	Max	Units	Conditions
Clock Parameters							
HAD50	TAD	ADC Clock Period ⁽¹⁾	104	—	—	ns	—
Conversion Rate							
HAD56	FCNV	Throughput Rate ⁽¹⁾	—	—	800	Ksps	—

Note 1: These parameters are characterized but not tested in manufacturing.

NOTES:

32.0 DC AND AC DEVICE CHARACTERISTICS GRAPHS

Note: The graphs provided following this note are a statistical summary based on a limited number of samples and are provided for design guidance purposes only. The performance characteristics listed herein are not tested or guaranteed. In some graphs, the data presented may be outside the specified operating range (e.g., outside specified power supply range) and therefore, outside the warranted range.

FIGURE 32-1: VOH – 2x DRIVER PINS

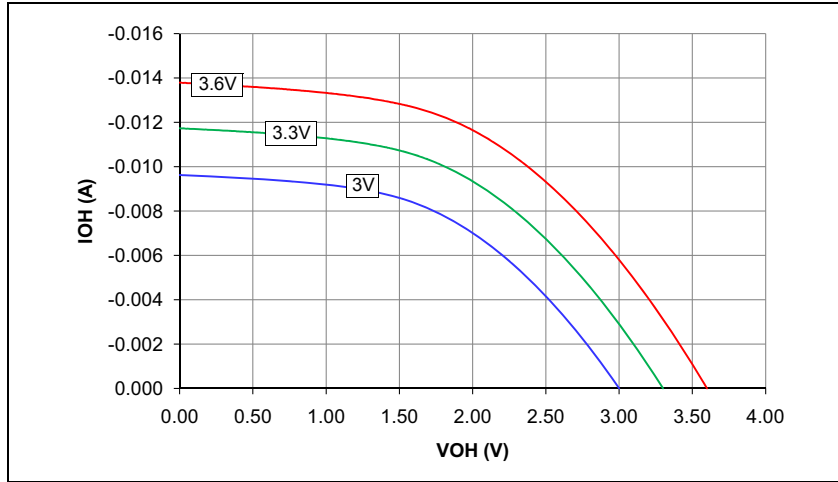

FIGURE 32-3: VOH – 8x DRIVER PINS

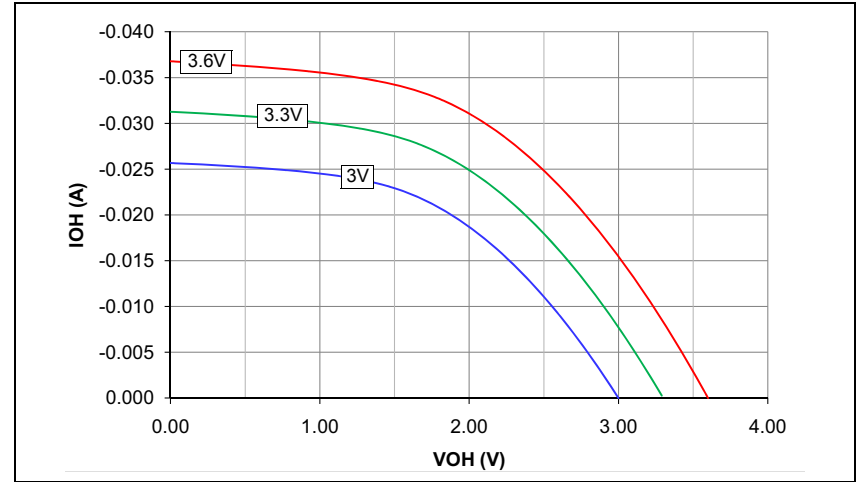

FIGURE 32-2: VOH – 4x DRIVER PINS

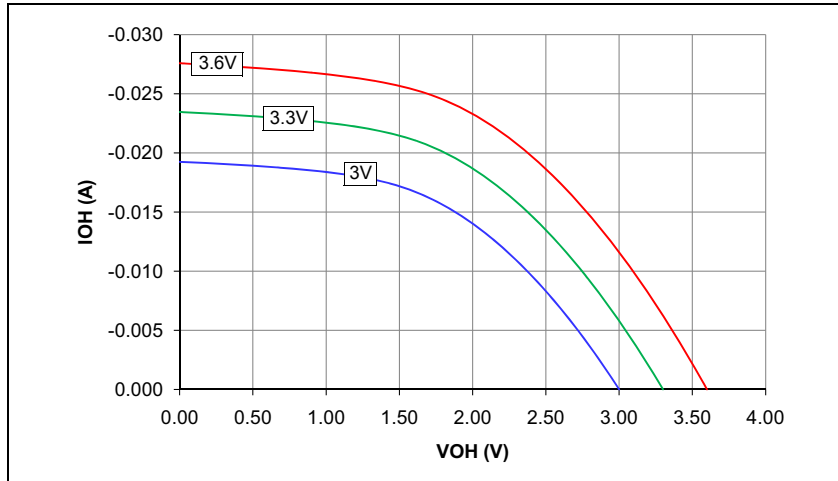

FIGURE 32-4: VOH – 16x DRIVER PINS

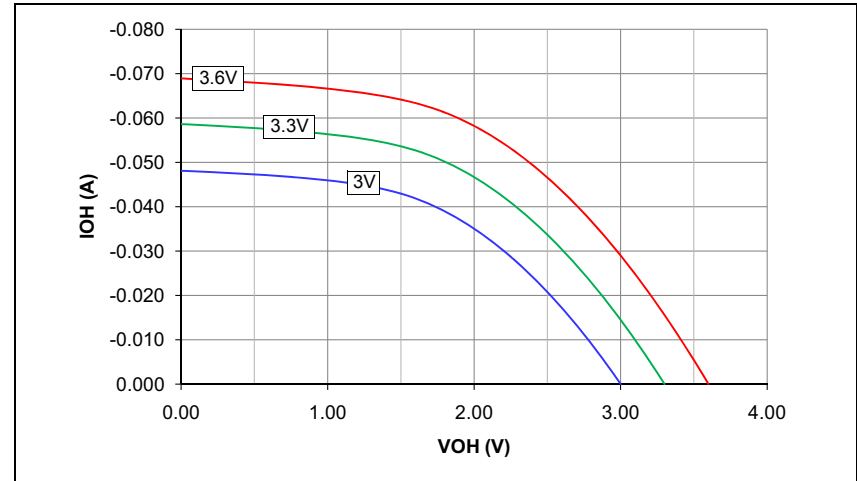

FIGURE 32-5: VOL – 2x DRIVER PINS



FIGURE 32-7: VOL – 8x DRIVER PINS



FIGURE 32-6: VOL – 4x DRIVER PINS



FIGURE 32-8: VOL – 16x DRIVER PINS



FIGURE 32-9: TYPICAL I_{PD} CURRENT @ V_{DD} = 3.3V, +85°C



FIGURE 32-11: TYPICAL I_{DOZE} CURRENT @ V_{DD} = 3.3V, +85°C



FIGURE 32-10: TYPICAL I_{DD} CURRENT @ V_{DD} = 3.3V, +85°C



FIGURE 32-12: TYPICAL I_{IDLE} CURRENT @ V_{DD} = 3.3V, +85°C



FIGURE 32-13: TYPICAL FRC FREQUENCY @ VDD = 3.3V

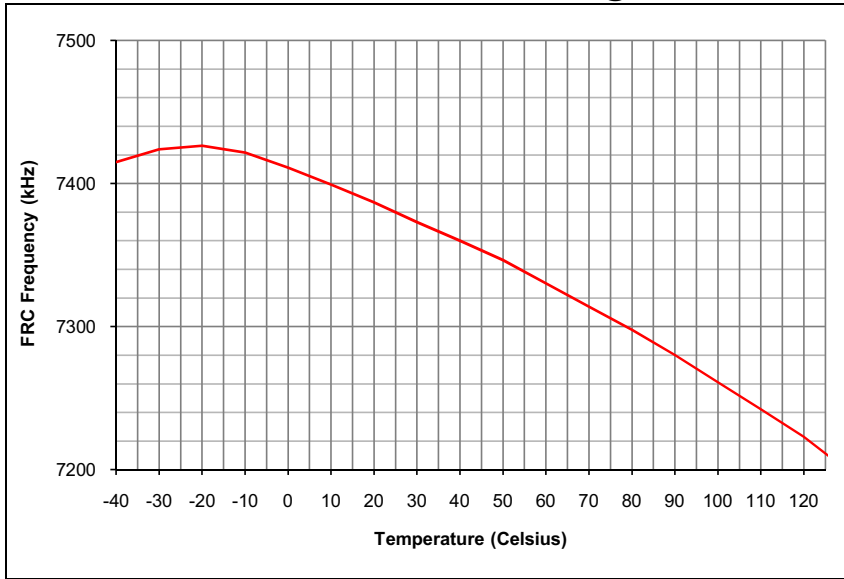
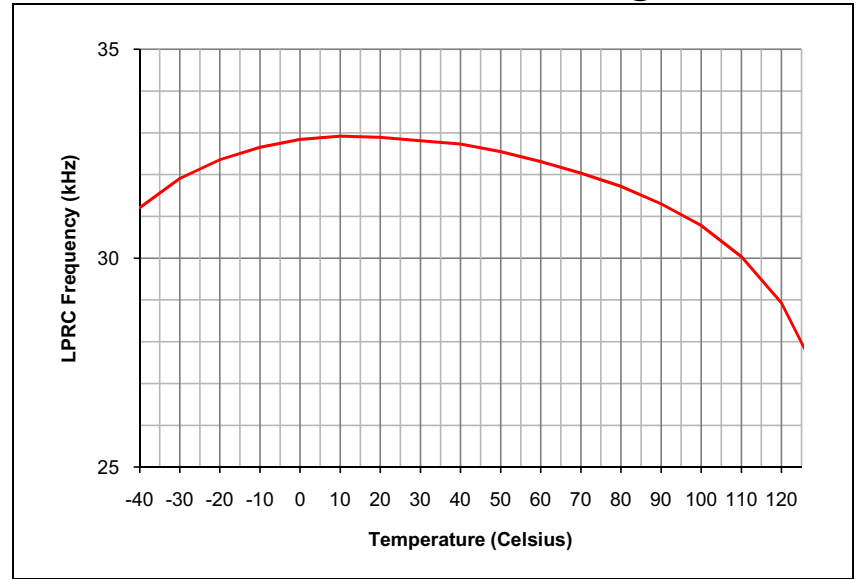
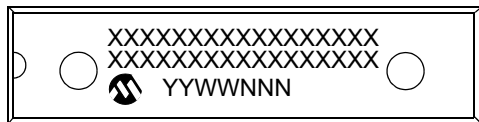

FIGURE 32-14: TYPICAL LPRC FREQUENCY @ VDD = 3.3V



33.0 PACKAGING INFORMATION

28-Lead SPDIP



Example

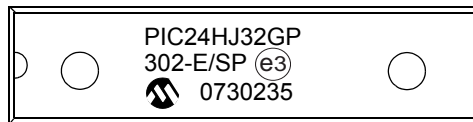

28-Lead SOIC (.300")

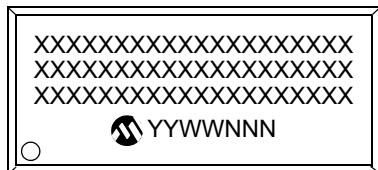

Example

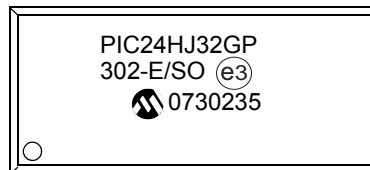

28-Lead QFN-S



Example



44-Lead QFN

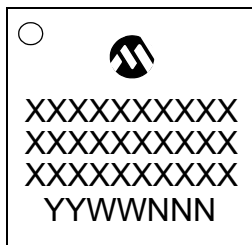

Example



44-Lead TQFP



Example



Legend:	XX...X	Customer-specific information
	Y	Year code (last digit of calendar year)
	YY	Year code (last 2 digits of calendar year)
	WW	Week code (week of January 1 is week '01')
	NNN	Alphanumeric traceability code
	(e3)	Pb-free JEDEC designator for Matte Tin (Sn)
	*	This package is Pb-free. The Pb-free JEDEC designator ((e3)) can be found on the outer packaging for this package.
Note:	If the full Microchip part number cannot be marked on one line, it is carried over to the next line, thus limiting the number of available characters for customer-specific information.	

33.1 Package Details

28-Lead Skinny Plastic Dual In-Line (SP) – 300 mil Body [SPDIP]

Note: For the most current package drawings, please see the Microchip Packaging Specification located at <http://www.microchip.com/packaging>



		Units	INCHES		
Dimension Limits			MIN	NOM	MAX
Number of Pins	N		28		
Pitch	e		.100 BSC		
Top to Seating Plane	A		–	–	.200
Molded Package Thickness	A2		.120	.135	.150
Base to Seating Plane	A1		.015	–	–
Shoulder to Shoulder Width	E		.290	.310	.335
Molded Package Width	E1		.240	.285	.295
Overall Length	D		1.345	1.365	1.400
Tip to Seating Plane	L		.110	.130	.150
Lead Thickness	c		.008	.010	.015
Upper Lead Width	b1		.040	.050	.070
Lower Lead Width	b		.014	.018	.022
Overall Row Spacing §	eB		–	–	.430

Notes:

1. Pin 1 visual index feature may vary, but must be located within the hatched area.
2. § Significant Characteristic.
3. Dimensions D and E1 do not include mold flash or protrusions. Mold flash or protrusions shall not exceed .010" per side.
4. Dimensioning and tolerancing per ASME Y14.5M.

BSC: Basic Dimension. Theoretically exact value shown without tolerances.

Microchip Technology Drawing C04-070B

28-Lead Plastic Small Outline (SO) – Wide, 7.50 mm Body [SOIC]

Note: For the most current package drawings, please see the Microchip Packaging Specification located at <http://www.microchip.com/packaging>

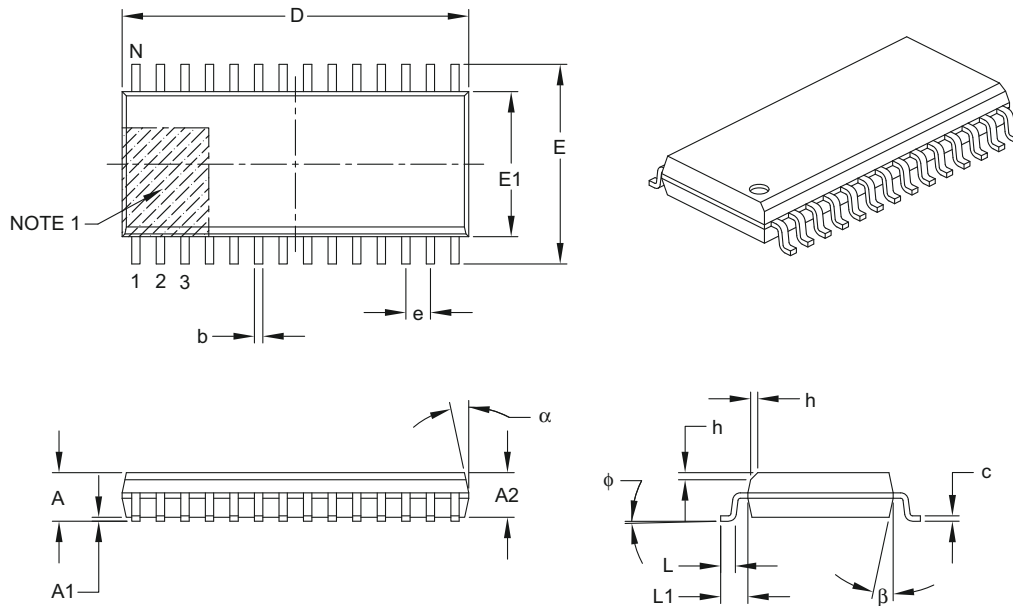

		Units	MILLMETERS		
Dimension Limits			MIN	NOM	MAX
Number of Pins	N		28		
Pitch	e		1.27 BSC		
Overall Height	A		–	–	2.65
Molded Package Thickness	A2		2.05	–	–
Standoff §	A1		0.10	–	0.30
Overall Width	E		10.30 BSC		
Molded Package Width	E1		7.50 BSC		
Overall Length	D		17.90 BSC		
Chamfer (optional)	h		0.25	–	0.75
Foot Length	L		0.40	–	1.27
Footprint	L1		1.40 REF		
Foot Angle Top	φ		0°	–	8°
Lead Thickness	c		0.18	–	0.33
Lead Width	b		0.31	–	0.51
Mold Draft Angle Top	α		5°	–	15°
Mold Draft Angle Bottom	β		5°	–	15°

Notes:

1. Pin 1 visual index feature may vary, but must be located within the hatched area.
2. § Significant Characteristic.
3. Dimensions D and E1 do not include mold flash or protrusions. Mold flash or protrusions shall not exceed 0.15 mm per side.
4. Dimensioning and tolerancing per ASME Y14.5M.

BSC: Basic Dimension. Theoretically exact value shown without tolerances.

REF: Reference Dimension, usually without tolerance, for information purposes only.

Microchip Technology Drawing C04-052B

28-Lead Plastic Quad Flat, No Lead Package (MM) – 6x6x0.9 mm Body [QFN-S] with 0.40 mm Contact Length

Note: For the most current package drawings, please see the Microchip Packaging Specification located at <http://www.microchip.com/packaging>

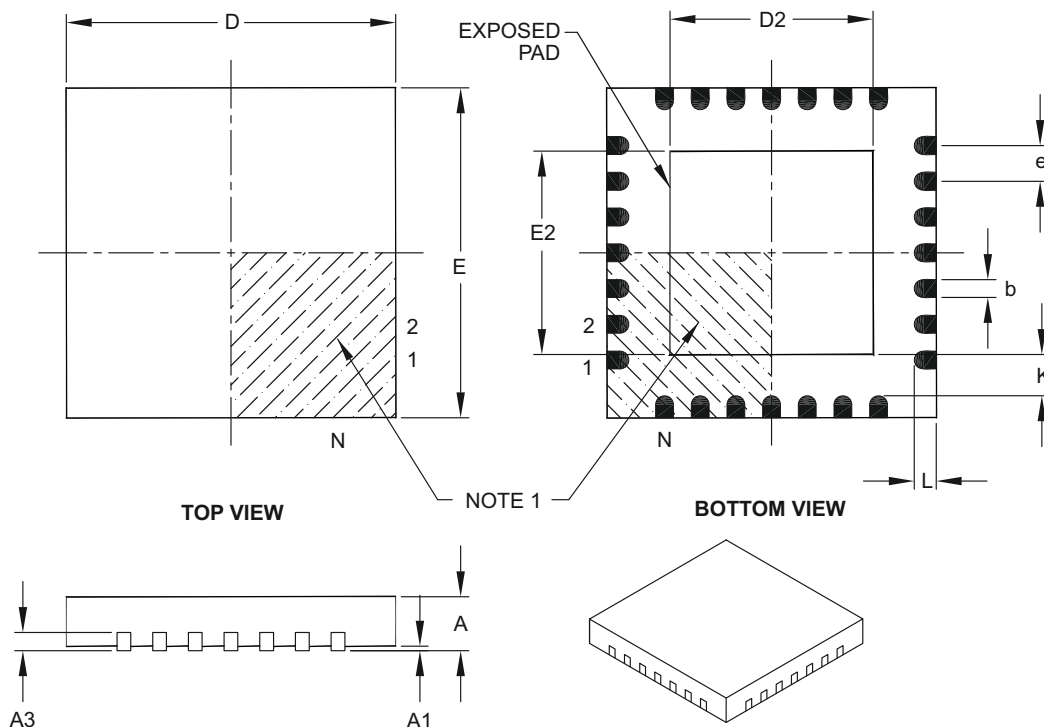

Dimension Limits	Units	MILLIMETERS		
		MIN	NOM	MAX
Number of Pins	N	28		
Pitch	e	0.65 BSC		
Overall Height	A	0.80	0.90	1.00
Standoff	A1	0.00	0.02	0.05
Contact Thickness	A3	0.20 REF		
Overall Width	E	6.00 BSC		
Exposed Pad Width	E2	3.65	3.70	4.70
Overall Length	D	6.00 BSC		
Exposed Pad Length	D2	3.65	3.70	4.70
Contact Width	b	0.23	0.38	0.43
Contact Length	L	0.30	0.40	0.50
Contact-to-Exposed Pad	K	0.20	-	-

Notes:

1. Pin 1 visual index feature may vary, but must be located within the hatched area.
2. Package is saw singulated.
3. Dimensioning and tolerancing per ASME Y14.5M.
 BSC: Basic Dimension. Theoretically exact value shown without tolerances.
 REF: Reference Dimension, usually without tolerance, for information purposes only.

Microchip Technology Drawing C04-124B

**28-Lead Plastic Quad Flat, No Lead Package (MM) – 6x6x0.9 mm Body [QFN-S]
with 0.40 mm Contact Length**

Note: For the most current package drawings, please see the Microchip Packaging Specification located at <http://www.microchip.com/packaging>



RECOMMENDED LAND PATTERN

Units		MILLIMETERS		
Dimension Limits		MIN	NOM	MAX
Contact Pitch	E	0.65 BSC		
Optional Center Pad Width	W2			4.70
Optional Center Pad Length	T2			4.70
Contact Pad Spacing	C1		6.00	
Contact Pad Spacing	C2		6.00	
Contact Pad Width (X28)	X1			0.40
Contact Pad Length (X28)	Y1			0.85
Distance Between Pads	G	0.25		

Notes:

1. Dimensioning and tolerancing per ASME Y14.5M

BSC: Basic Dimension. Theoretically exact value shown without tolerances.

Microchip Technology Drawing No. C04-2124A

44-Lead Plastic Quad Flat, No Lead Package (ML) – 8x8 mm Body [QFN]

Note: For the most current package drawings, please see the Microchip Packaging Specification located at <http://www.microchip.com/packaging>



		Units	MILLIMETERS		
Dimension Limits			MIN	NOM	MAX
Number of Pins	N		44		
Pitch	e		0.65 BSC		
Overall Height	A		0.80	0.90	1.00
Standoff	A1		0.00	0.02	0.05
Contact Thickness	A3		0.20 REF		
Overall Width	E		8.00 BSC		
Exposed Pad Width	E2		6.30	6.45	6.80
Overall Length	D		8.00 BSC		
Exposed Pad Length	D2		6.30	6.45	6.80
Contact Width	b		0.25	0.30	0.38
Contact Length	L		0.30	0.40	0.50
Contact-to-Exposed Pad	K		0.20	-	-

Notes:

1. Pin 1 visual index feature may vary, but must be located within the hatched area.
2. Package is saw singulated.
3. Dimensioning and tolerancing per ASME Y14.5M.

BSC: Basic Dimension. Theoretically exact value shown without tolerances.

REF: Reference Dimension, usually without tolerance, for information purposes only.

Microchip Technology Drawing C04-103B

44-Lead Plastic Quad Flat, No Lead Package (ML) – 8x8 mm Body [QFN]

Note: For the most current package drawings, please see the Microchip Packaging Specification located at <http://www.microchip.com/packaging>



RECOMMENDED LAND PATTERN

Dimension Limits	Units	MILLIMETERS		
		MIN	NOM	MAX
Contact Pitch	E	0.65 BSC		
Optional Center Pad Width	W2			6.80
Optional Center Pad Length	T2			6.80
Contact Pad Spacing	C1		8.00	
Contact Pad Spacing	C2		8.00	
Contact Pad Width (X44)	X1			0.35
Contact Pad Length (X44)	Y1			0.80
Distance Between Pads	G	0.25		

Notes:

1. Dimensioning and tolerancing per ASME Y14.5M

BSC: Basic Dimension. Theoretically exact value shown without tolerances.

Microchip Technology Drawing No. C04-2103A

44-Lead Plastic Thin Quad Flatpack (PT) – 10x10x1 mm Body, 2.00 mm Footprint [TQFP]

Note: For the most current package drawings, please see the Microchip Packaging Specification located at <http://www.microchip.com/packaging>



Dimension Limits	Units	MILLIMETERS		
		MIN	NOM	MAX
Number of Leads	N	44		
Lead Pitch	e	0.80 BSC		
Overall Height	A	–	–	1.20
Molded Package Thickness	A2	0.95	1.00	1.05
Standoff	A1	0.05	–	0.15
Foot Length	L	0.45	0.60	0.75
Footprint	L1	1.00 REF		
Foot Angle	ϕ	0°	3.5°	7°
Overall Width	E	12.00 BSC		
Overall Length	D	12.00 BSC		
Molded Package Width	E1	10.00 BSC		
Molded Package Length	D1	10.00 BSC		
Lead Thickness	c	0.09	–	0.20
Lead Width	b	0.30	0.37	0.45
Mold Draft Angle Top	α	11°	12°	13°
Mold Draft Angle Bottom	β	11°	12°	13°

Notes:

- Pin 1 visual index feature may vary, but must be located within the hatched area.
- Chamfers at corners are optional; size may vary.
- Dimensions D1 and E1 do not include mold flash or protrusions. Mold flash or protrusions shall not exceed 0.25 mm per side.
- Dimensioning and tolerancing per ASME Y14.5M.

BSC: Basic Dimension. Theoretically exact value shown without tolerances.

REF: Reference Dimension, usually without tolerance, for information purposes only.

Microchip Technology Drawing C04-076B

44-Lead Plastic Thin Quad Flatpack (PT) – 10x10x1 mm Body, 2.00 mm [TQFP]

Note: For the most current package drawings, please see the Microchip Packaging Specification located at <http://www.microchip.com/packaging>



RECOMMENDED LAND PATTERN

Dimension Limits	Units	MILLIMETERS		
		MIN	NOM	MAX
Contact Pitch	E	0.80 BSC		
Contact Pad Spacing	C1		11.40	
Contact Pad Spacing	C2		11.40	
Contact Pad Width (X44)	X1			0.55
Contact Pad Length (X44)	Y1			1.50
Distance Between Pads	G	0.25		

Notes:

1. Dimensioning and tolerancing per ASME Y14.5M

BSC: Basic Dimension. Theoretically exact value shown without tolerances.

Microchip Technology Drawing No. C04-2076A

NOTES:

APPENDIX A: REVISION HISTORY

Revision A (September 2007)

Initial release of this document.

Revision B (March 2008)

This revision includes minor typographical and formatting changes throughout the data sheet text. In addition, redundant information was removed that is now available in the respective chapters of the *dsPIC33F/PIC24H Family Reference Manual*, which can be obtained from the Microchip web site (www.microchip.com).

The major changes are referenced by their respective section in the following table.

TABLE A-1: MAJOR SECTION UPDATES

Section Name	Update Description
"High-Performance, 16-bit Microcontrollers"	Note 1 added to all pin diagrams (see "Pin Diagrams") Updated the "PIC24HJ32GP302/304, PIC24HJ64GPX02/X04 and PIC24HJ128GPX02/X04 Controller Families" table as follows: <ul style="list-style-type: none"> • PIC24HJ128GP804 changed to PIC24HJ128GP504 • PIC24HJ128GP804 changed to PIC24HJ128GP504 • Added new column: External Interrupts • Added Note 3
Section 1.0 "Device Overview"	Updated parameters PMA0, PMA1 and PMD0 through PMPD7 (Table 1-1)
Section 6.0 "Interrupt Controller"	IFS0-IFS04 changed to IFSx (see Section 6.3.2 "IFSx") IEC0-IEC4 changed to IECx (see Section 6.3.3 "IECx") IPC0-IPC19 changed to IPCx (see Section 6.3.4 "IPCx")
Section 7.0 "Direct Memory Access (DMA)"	Updated parameter PMP (see Table 7-1)
Section 8.0 "Oscillator Configuration"	Updated the third clock source item (External Clock) in Section 8.1.1 "System Clock Sources" Updated TUN<5:0> (OSCTUN<5:0>) bit description (see Register 8-4)
Section 19.0 "10-bit/12-bit Analog-to-Digital Converter (ADC1)"	Added Note 2 to Figure 19-3
Section 24.0 "Special Features"	Added Note 2 to Figure 24-1 Added Note after second paragraph in Section 24.2 "On-Chip Voltage Regulator"

TABLE A-1: MAJOR SECTION UPDATES (CONTINUED)

Section Name	Update Description
Section 27.0 “Electrical Characteristics”	Updated Max MIPS for temperature range of -40°C to +125°C in Table 27-1 Updated typical values in Thermal Packaging Characteristics in Table 27-3 Added parameters DI11 and DI12 to Table 27-9 Updated minimum values for parameters D136 (TRW) and D137 (TPE) and removed typical values in Table 27-12 Added Extended temperature range to Table 27-13 Updated parameter AD63 and added Note 3 to Table 27-38 and Table 27-39

Revision C (May 2009)

This revision includes minor typographical and formatting changes throughout the data sheet text.

Global changes include:

- Changed all instances of OSCI to OSC1 and OSCO to OSC2
- Changed all instances of VDDCORE and VDDCORE/VCAP to VCAP/VDDCORE

The other changes are referenced by their respective section in the following table.

TABLE A-2: MAJOR SECTION UPDATES

Section Name	Update Description
“High-Performance, 16-bit Microcontrollers”	Updated all pin diagrams to denote the pin voltage tolerance (see “Pin Diagrams”). Added Note 2 to the 28-Pin QFN-S and 44-Pin QFN pin diagrams, which references pin connections to Vss.
Section 1.0 “Device Overview”	Updated AVDD in the PINOUT I/O Descriptions (see Table 1-1).
Section 2.0 “Guidelines for Getting Started with 16-bit Microcontrollers”	Added new section to the data sheet that provides guidelines on getting started with 16-bit Digital Signal Controllers. Added Peripheral Pin Select (PPS) capability column to Pinout I/O Descriptions (see Table 1-1).
Section 3.0 “CPU”	Updated CPU Core Block Diagram with a connection from the DSP Engine to the Y Data Bus (see Figure 3-1).
Section 4.0 “Memory Organization”	Updated Reset value for CORCON in the CPU Core Register Map (see Table 4-1). Updated Reset value for IPC15 in the Interrupt Controller Register Map (see Table 4-4). Removed the FLTA1IE bit (IEC3) from the Interrupt Controller Register Map (see Table 4-4). Updated bit locations for RPINR25 in the Peripheral Pin Select Input Register Map (see Table 4-19). Updated the Reset value for CLKDIV in the System Control Register Map (see Table 4-31).
Section 5.0 “Flash Program Memory”	Updated Section 5.3 “Programming Operations” with programming time formula.
Section 9.0 “Oscillator Configuration”	Updated the Oscillator System Diagram and added Note 2 (see Figure 9-1). Updated default bit values for DOZE<2:0> and FRCDIV<2:0> in the Clock Divisor (CLKDIV) Register (see Register 9-2). Added a paragraph regarding FRC accuracy at the end of Section 9.1.1 “System Clock Sources” . Added Note 3 to Section 9.2.2 “Oscillator Switching Sequence” . Added Note 1 to the FRC Oscillator Tuning (OSCTUN) Register (see Register 9-4).

TABLE A-2: MAJOR SECTION UPDATES (CONTINUED)

Section Name	Update Description
Section 10.0 “Power-Saving Features”	Added the following registers: <ul style="list-style-type: none"> • PMD1: Peripheral Module Disable Control Register 1 (Register 10-1) • PMD2: Peripheral Module Disable Control Register 2 (Register 10-2) • PMD3: Peripheral Module Disable Control Register 3 (Register 10-3)
Section 11.0 “I/O Ports”	Removed Table 11-1 and added reference to pin diagrams for I/O pin availability and functionality. Added paragraph on ADPCFG register default values to Section 11.3 “Configuring Analog Port Pins” . Added Note box regarding PPS functionality with input mapping to Section 11.6.2.1 “Input Mapping” .
Section 16.0 “Serial Peripheral Interface (SPI)”	Added Note 2 and 3 to the SPIxCON1 register (see Register 16-2).
Section 18.0 “Universal Asynchronous Receiver Transmitter (UART)”	Updated the Notes in the UxMode register (see Register 18-1). Updated the UTXINV bit settings in the UxSTA register (see Register 18-2).
Section 19.0 “Enhanced CAN (ECAN™) Module”	Changed bit 11 in the ECAN Control Register 1 (CiCTRL1) to Reserved (see Register 19-1).
Section 20.0 “10-bit/12-bit Analog-to-Digital Converter (ADC1)”	Replaced the ADC1 Module Block Diagrams with new diagrams (see Figure 20-1 and Figure 20-2). Updated bit values for ADCS<7:0> and added Notes 1 and 2 to the ADC1 Control Register 3 (AD1CON3) (see Register 20-3). Added Note 2 to the ADC1 Input Scan Select Register Low (AD1CSSL) (see Register 20-7). Added Note 2 to the ADC1 Port Configuration Register Low (AD1PCFGL) (see Register 20-8).
Section 21.0 “Comparator Module”	Updated the Comparator Voltage Reference Block Diagram (see Figure 21-2).
Section 22.0 “Real-Time Clock and Calendar (RTCC)”	Updated the minimum positive adjust value for CAL<7:0> in the RTCC Calibration and Configuration (RCFGCAL) Register (see Register 22-1).
Section 25.0 “Special Features”	Added Note 1 to the Device Configuration Register Map (see Table 25-1). Updated Note 1 in the PIC24H Configuration Bits Description (see Table 25-2).

TABLE A-2: MAJOR SECTION UPDATES (CONTINUED)

Section Name	Update Description
<p>Section 28.0 “Electrical Characteristics”</p>	<p>Updated Typical values for Thermal Packaging Characteristics (see Table 28-3).</p> <p>Updated Min and Max values for parameter DC12 (RAM Data Retention Voltage) and added Note 4 (see Table 28-4).</p> <p>Updated Power-Down Current Max values for parameters DC60b and DC60c (see Table 28-7).</p> <p>Updated Characteristics for I/O Pin Input Specifications (see Table 28-9).</p> <p>Updated Program Memory values for parameters 136, 137 and 138 (renamed to 136a, 137a and 138a), added parameters 136b, 137b and 138b, and added Note 2 (see Table 28-12).</p> <p>Added parameter OS42 (GM) to the External Clock Timing Requirements (see Table 28-16).</p> <p>Updated Watchdog Timer Time-out Period parameter SY20 (see Table 28-21).</p>

Revision D (November 2009)

The revision includes the following global update:

- Added Note 2 to the shaded table that appears at the beginning of each chapter. This new note provides information regarding the availability of registers and their associated bits

This revision also includes minor typographical and formatting changes throughout the data sheet text.

All other major changes are referenced by their respective section in the following table.

TABLE A-3: MAJOR SECTION UPDATES

Section Name	Update Description
“High-Performance, 16-bit Microcontrollers”	Added information on high temperature operation (see “Operating Range:”).
Section 11.0 “I/O Ports”	Changed the reference to digital-only pins to 5V tolerant pins in the second paragraph of Section 11.2 “Open-Drain Configuration” .
Section 18.0 “Universal Asynchronous Receiver Transmitter (UART)”	Updated the two baud rate range features to: 10 Mbps to 38 bps at 40 MIPS.
Section 20.0 “10-bit/12-bit Analog-to-Digital Converter (ADC1)”	Updated the ADC block diagrams (see Figure 20-1 and Figure 20-2).
Section 25.0 “Special Features”	Updated the second paragraph and removed the fourth paragraph in Section 25.1 “Configuration Bits” . Updated the Device Configuration Register Map (see Table 28-1).
Section 28.0 “Electrical Characteristics”	Updated the Absolute Maximum Ratings for high temperature and added Note 4. Removed parameters DI26, DI28 and DI29 from the I/O Pin Input Specifications (see Table 28-9). Updated the SPIx Module Slave Mode (CKE = 1) Timing Characteristics (see Figure 28-12).
Section 29.0 “High Temperature Electrical Characteristics”	Added new chapter with high temperature specifications.
“Product Identification System”	Added the “H” definition for high temperature.

Revision E (January 2011)

This includes typographical and formatting changes throughout the data sheet text. In addition, the Preliminary marking in the footer was removed.

All occurrences of VDDCORE have been removed throughout the document.

All other major changes are referenced by their respective section in the following table.

TABLE A-4: MAJOR SECTION UPDATES

Section Name	Update Description
"High-Performance, 16-bit Microcontrollers"	The high temperature end range was updated to +150°C (see "Operating Range:").
Section 2.0 "Guidelines for Getting Started with 16-bit Microcontrollers"	The frequency limitation for device PLL start-up conditions was updated in Section 2.7 "Oscillator Value Conditions on Device Start-up". The second paragraph in Section 2.9 "Unused I/Os" was updated.
Section 4.0 "Memory Organization"	The All Resets values for the following SFRs in the Timer Register Map were changed (see Table 4-5): <ul style="list-style-type: none"> • TMR1 • TMR2 • TMR3 • TMR4 • TMR5
Section 9.0 "Oscillator Configuration"	Added Note 3 to the OSCCON: Oscillator Control Register (see Register 9-1). Added Note 2 to the CLKDIV: Clock Divisor Register (see Register 9-2). Added Note 1 to the PLLFBD: PLL Feedback Divisor Register (see Register 9-3). Added Note 2 to the OSCTUN: FRC Oscillator Tuning Register (see Register 9-4).
Section 20.0 "10-bit/12-bit Analog-to-Digital Converter (ADC1)"	Updated the VREFL references in the ADC1 module block diagrams (see Figure 20-1 and Figure 20-2).
Section 25.0 "Special Features"	Added a new paragraph and removed the third paragraph in Section 25.1 "Configuration Bits". Added the column "RTSP Effects" to the dsPIC33F Configuration Bits Descriptions (see Table 25-2).

TABLE A-4: MAJOR SECTION UPDATES (CONTINUED)

Section Name	Update Description
<p>Section 28.0 “Electrical Characteristics”</p>	<p>Updated the maximum value for Extended Temperature Devices in the Thermal Operating Conditions (see Table 28-2).</p> <p>Removed Note 4 from the DC Temperature and Voltage Specifications (see Table 28-4).</p> <p>Updated all typical and maximum Operating Current (IDD) values (see Table 28-5).</p> <p>Updated all typical and maximum Idle Current (IDLE) values (see Table 28-6).</p> <p>Updated the maximum Power-Down Current (IPD) values for parameters DC60d, DC60a, and DC60b (see Table 28-7).</p> <p>Updated all typical Doze Current (I_{doze}) values (see Table 28-8).</p> <p>Updated the maximum value for parameter DI19 and added parameters DI28, DI29, DI60a, DI60b, and DI60c to the I/O Pin Input Specifications (see Table 28-9).</p> <p>Added Note 2 to the PLL Clock Timing Specifications (see Table 28-17)</p> <p>Removed Note 2 from the AC Characteristics: Internal RC Accuracy (see Table 28-18).</p> <p>Updated the Internal RC Accuracy minimum and maximum values for parameter F21b (see Table 28-19).</p> <p>Updated the characteristic description for parameter DI35 in the I/O Timing Requirements (see Table 28-20).</p> <p>Updated <i>all</i> SPI specifications (see Table 28-28 through Table 28-35 and Figure 28-10 through Figure 28-16)</p> <p>Updated the ADC Module Specification minimum values for parameters AD05 and AD07, and updated the maximum value for parameter AD06 (see Table 28-41).</p> <p>Updated the ADC Module Specifications (12-bit Mode) minimum and maximum values for parameter AD21a (see Table 28-42).</p> <p>Updated all ADC Module Specifications (10-bit Mode) values, with the exception of Dynamic Performance (see Table 28-43).</p> <p>Updated the minimum value for parameter PM6 and the maximum value for parameter PM7 in the Parallel Master Port Read Timing Requirements (see Table 28-49).</p> <p>Added DMA Read/Write Timing Requirements (see Table 28-51).</p>

TABLE A-4: MAJOR SECTION UPDATES (CONTINUED)

Section Name	Update Description
Section 29.0 “High Temperature Electrical Characteristics”	<p>Updated all ambient temperature end range values to +150°C throughout the chapter.</p> <p>Updated the storage temperature end range to +160°C.</p> <p>Updated the maximum junction temperature from +145°C to +155°C.</p> <p>Updated the maximum values for High Temperature Devices in the Thermal Operating Conditions (see Table 29-2).</p> <p>Updated the ADC Module Specifications (12-bit Mode), removing all parameters with the exception of HAD33a (see Table 29-14).</p> <p>Updated the ADC Module Specifications (10-bit Mode), removing all parameters with the exception of HAD33b (see Table 29-16).</p>
“Product Identification System”	Updated the end range temperature value for H (High) devices.

Revision F (August 2011)

This revision includes typographical and formatting changes throughout the data sheet text.

All other major changes are referenced by their respective section in the following table.

TABLE A-5: MAJOR SECTION UPDATES

Section Name	Update Description
Section 25.0 “Special Features”	Added Note 3 to the Connections for the On-chip Voltage Regulator diagram (see Figure 25-1).
Section 28.0 “Electrical Characteristics”	Removed Voltage on VCAP with respect to Vss from the Absolute Maximum Ratings. Removed Note 3 and parameter DC10 (V _{CORE}) from the DC Temperature and Voltage Specifications (see Table 28-4). Updated the Characteristics definition and Conditions for parameter BO10 in the Electrical Characteristics: BOR (see Table 28-11). Added Note 1 to the Internal Voltage Regulator Specifications (see Table 28-13).

Revision G (April 2012)

This revision includes typographical and formatting changes throughout the data sheet text.

In addition, where applicable, new sections were added to each peripheral chapter that provide information and links to related resources, as well as helpful tips. For examples, see [Section 9.2 “Oscillator Resources”](#) and [Section 20.4 “ADC Helpful Tips”](#).

All other major changes are referenced by their respective section in the following table.

TABLE A-6: MAJOR SECTION UPDATES

Section Name	Update Description
Section 2.0 “Guidelines for Getting Started with 16-bit Microcontrollers”	Added two new tables: <ul style="list-style-type: none"> • Crystal Recommendations (see Table 2-1) • Resonator Recommendations (see Table 2-2)
Section 28.0 “Electrical Characteristics”	Updated parameters DO10 and DO20 and removed parameters DO16 and DO26 in the DC Characteristics: I/O Pin Output Specifications (see Table 28-10)

INDEX

A

A/D Converter 227
 DMA 227
 Initialization 227
 Key Features 227
 AC Characteristics 306, 348
 ADC Module 351
 ADC Module (10-bit Mode) 352
 ADC Module (12-bit Mode) 351
 Internal RC Accuracy 308
 Load Conditions 306, 348
 ADC Module
 ADC11 Register Map 36
 Alternate Interrupt Vector Table (AIVT) 69
 Arithmetic Logic Unit (ALU) 23
 Assembler
 MPASM Assembler 292

B

Block Diagrams
 16-bit Timer1 Module 161
 A/D Module 228, 229
 Connections for On-Chip Voltage Regulator 277
 Device Clock 119, 121
 ECAN Module 201
 Input Capture 171
 Output Compare 175
 PIC24HJ32GP302/304, PIC24HJ64GPX02/X04, and
 PIC24HJ128GPX02/X04 10
 PIC24HJ32GP302/304, PIC24HJ64GPX02/X04, and
 PIC24HJ128GPX02/X04 CPU Core 18
 PLL 121
 Reset System 59
 Shared Port Structure 135
 SPI 179
 Timer2 (16-bit) 165
 Timer2/3 (32-bit) 167
 UART 193
 Watchdog Timer (WDT) 278

C

C Compilers
 MPLAB C18 292
 Clock Switching 128
 Enabling 128
 Sequence 128
 Code Examples
 Erasing a Program Memory Page 57
 Initiating a Programming Sequence 58
 Loading Write Buffers 58
 Port Write/Read 136
 PWRSAV Instruction Syntax 129
 Code Protection 273, 279
 Configuration Bits 273
 Configuration Register Map 273
 Configuring Analog Port Pins 136
 CPU
 Control Register 21
 CPU Clocking System 120
 PLL Configuration 121
 Selection 120
 Sources 120
 Customer Change Notification Service 387
 Customer Notification Service 387
 Customer Support 387

D

Data Address Space 27
 Alignment 27
 Memory Map for PIC24HJ128GP202/204 and
 PIC24HJ64GP202/204 Devices
 with 8 KB RAM 29
 Memory Map for PIC24HJ32GP302/304 Devices
 with 4 KB RAM 28
 Near Data Space 27
 Software Stack 47
 Width 27
 DC and AC Characteristics
 Graphs and Tables 355
 DC Characteristics 296
 Doze Current (IDOZE) 347
 High Temperature 346
 I/O Pin Input Specifications 301
 I/O Pin Output 347
 I/O Pin Output Specifications 304
 Idle Current (IDOZE) 300
 Idle Current (IDLE) 299
 Operating Current (IDD) 298
 Operating MIPS vs. Voltage 346
 Power-Down Current (IPD) 300
 Power-down Current (IPD) 346
 Program Memory 305, 347
 Temperature and Voltage 346
 Temperature and Voltage Specifications 297
 Thermal Operating Conditions 346
 Development Support 291
 DMA Module
 DMA Register Map 37
 DMAC Registers 109
 DMAxCNT 109
 DMAxCON 109
 DMAxPAD 109
 DMAxREQ 109
 DMAxSTA 109
 DMAxSTB 109
 Doze Mode 130

E

ECAN Module
 CiBUFNT1 register 213
 CiBUFNT2 register 214
 CiBUFNT3 register 214
 CiBUFNT4 register 215
 CiCFG1 register 211
 CiCFG2 register 212
 CiCTRL1 register 204
 CiCTRL2 register 205
 CiEC register 211
 CiFCTRL register 207
 CiFEN1 register 213
 CiFIFO register 208
 CiFMSKSEL1 register 217
 CiFMSKSEL2 register 218
 CiINTE register 210
 CiINTF register 209
 CiRXFnEID register 217
 CiRXFnSID register 216
 CiRXFUL1 register 220
 CiRXFUL2 register 220
 CiRXMnEID register 219
 CiRXMnSID register 219
 CiRXOVF1 register 221

PIC24HJ32GP302/304, PIC24HJ64GPX02/X04 AND PIC24HJ128GPX02/X04

CiRXOVF2 register	221	In-Circuit Emulation	273
CiTRmnCON register	222	In-Circuit Serial Programming (ICSP).....	273, 279
CiVEC register	206	Input Capture	171
ECAN1 Register Map (C1CTRL1.WIN = 0 or 1)	39	Registers	173
ECAN1 Register Map (C1CTRL1.WIN = 0)	39	Input Change Notification	136
ECAN1 Register Map (C1CTRL1.WIN = 1)	40	Instruction Addressing Modes	47
Frame Types	200	File Register Instructions	47
Modes of Operation	202	Fundamental Modes Supported	48
Overview	199	MCU Instructions	47
ECAN Registers		Move and Accumulator Instructions.....	48
Acceptance Filter Enable Register (CiFEN1).....	213	Other Instructions	48
Acceptance Filter Extended Identifier Register n (CiRXFnEID)	217	Instruction Set	
Acceptance Filter Mask Extended Identifier Register n (CiRXMnEID)	219	Overview	285
Acceptance Filter Mask Standard Identifier Register n (CiRXMnSID)	219	Summary	283
Acceptance Filter Standard Identifier Register n (CiRXFnSID)	216	Instruction-Based Power-Saving Modes.....	129
Baud Rate Configuration Register 1 (CiCFG1).....	211	Idle	130
Baud Rate Configuration Register 2 (CiCFG2).....	212	Sleep	129
Control Register 1 (CiCTRL1).....	204	Internal RC Oscillator	
Control Register 2 (CiCTRL2).....	205	Use with WDT.....	278
FIFO Control Register (CiFCTRL)	207	Internet Address	387
FIFO Status Register (CiFIFO)	208	Interrupt Control and Status Registers	73
Filter 0-3 Buffer Pointer Register (CiBFPNT1)	213	IECx	73
Filter 12-15 Buffer Pointer Register (CiBFPNT4)	215	IFSx	73
Filter 15-8 Mask Selection Register (CiFMSKSEL2).....	218	INTCON1	73
Filter 4-7 Buffer Pointer Register (CiBFPNT2)	214	INTCON2.....	73
Filter 7-0 Mask Selection Register (CiFMSKSEL1).....	217	IPCx.....	73
Filter 8-11 Buffer Pointer Register (CiBFPNT3)	214	Interrupt Setup Procedures.....	106
Interrupt Code Register (CiVEC)	206	Initialization	106
Interrupt Enable Register (CiINTE)	210	Interrupt Disable	106
Interrupt Flag Register (CiINTF)	209	Interrupt Service Routine	106
Receive Buffer Full Register 1 (CiRXFUL1).....	220	Trap Service Routine	106
Receive Buffer Full Register 2 (CiRXFUL2).....	220	Interrupt Vector Table (IVT)	69
Receive Buffer Overflow Register 2 (CiRXOVF2).....	221	Interrupts Coincident with Power Save Instructions	130
Receive Overflow Register (CiRXOVF1)	221	J	
ECAN Transmit/Receive Error Count Register (CiEC)	211	JTAG Boundary Scan Interface	273
ECAN TX/RX Buffer m Control Register (CiTRmnCON)	222	JTAG Interface.....	279
Electrical Characteristics	295	M	
AC	306, 348	Memory Organization	25
Enhanced CAN Module.....	199	Microchip Internet Web Site.....	387
Equations		Modes of Operation	
Device Operating Frequency	120	Disable	202
Errata	3	Initialization	202
F		Listen All Messages.....	202
Flash Program Memory.....	53	Listen Only.....	202
Control Registers	54	Loopback	202
Operations	54	Normal Operation	202
Programming Algorithm	57	MPLAB ASM30 Assembler, Linker, Librarian	292
RTSP Operation.....	54	MPLAB Integrated Development Environment Software	291
Table Instructions.....	53	MPLAB PM3 Device Programmer	294
Flexible Configuration	273	MPLAB REAL ICE In-Circuit Emulator System	293
H		MPLINK Object Linker/MPLIB Object Librarian	292
High Temperature Electrical Characteristics	345, 362	Multi-Bit Data Shifter.....	23
I		N	
I/O Ports	135	NVM Module	
Parallel I/O (PIO).....	135	Register Map	46
Write/Read Timing	136	O	
i ² C		Open-Drain Configuration.....	136
Operating Modes	185	Output Compare	175
Registers	185	P	
In-Circuit Debugger	279	Packaging	363
		Details.....	364
		Marking	363

PIC24HJ32GP302/304, PIC24HJ64GPX02/X04 AND PIC24HJ128GPX02/X04

<p>Peripheral Module Disable (PMD) 130</p> <p>Pinout I/O Descriptions 11</p> <p>PMD Module</p> <p style="padding-left: 20px;">Register Map..... 46</p> <p>PORTA</p> <p style="padding-left: 20px;">Register Map..... 44, 45</p> <p>PORTB</p> <p style="padding-left: 20px;">Register Map..... 45</p> <p>Power-on Reset (POR) 65</p> <p>Power-Saving Features 129</p> <p style="padding-left: 20px;">Clock Frequency and Switching..... 129</p> <p>Program Address Space 25</p> <p style="padding-left: 20px;">Construction..... 49</p> <p style="padding-left: 20px;">Data Access from Program Memory</p> <p style="padding-left: 40px;">Using Program Space Visibility..... 52</p> <p style="padding-left: 20px;">Data Access from Program Memory</p> <p style="padding-left: 40px;">Using Table Instructions 51</p> <p style="padding-left: 20px;">Data Access from, Address Generation..... 50</p> <p style="padding-left: 20px;">Memory Map 25</p> <p style="padding-left: 20px;">Table Read Instructions</p> <p style="padding-left: 40px;">TBLRDH 51</p> <p style="padding-left: 40px;">TBLRDL 51</p> <p style="padding-left: 20px;">Visibility Operation 52</p> <p>Program Memory</p> <p style="padding-left: 20px;">Interrupt Vector 26</p> <p style="padding-left: 20px;">Organization..... 26</p> <p style="padding-left: 20px;">Reset Vector 26</p> <p>R</p> <p>Reader Response 388</p> <p>Register Map</p> <p style="padding-left: 20px;">CRC 44</p> <p style="padding-left: 20px;">Dual Comparator..... 44</p> <p style="padding-left: 20px;">Parallel Master/Slave Port 43</p> <p style="padding-left: 20px;">Real-Time Clock and Calendar..... 44</p> <p>Registers</p> <p style="padding-left: 20px;">AD1CHS0 (ADC1 Input Channel 0 Select) 238</p> <p style="padding-left: 20px;">AD1CHS123 (ADC1 Input Channel 1, 2, 3 Select) ... 237</p> <p style="padding-left: 20px;">AD1CON1 (ADC1 Control 1) 232</p> <p style="padding-left: 20px;">AD1CON2 (ADC1 Control 2) 234</p> <p style="padding-left: 20px;">AD1CON3 (ADC1 Control 3) 235</p> <p style="padding-left: 20px;">AD1CON4 (ADC1 Control 4) 236</p> <p style="padding-left: 20px;">AD1CSSL (ADC1 Input Scan Select Low) 239</p> <p style="padding-left: 20px;">AD1PCFGL (ADC1 Port Configuration Low) 239</p> <p style="padding-left: 20px;">CiBUFNT1 (ECAN Filter 0-3 Buffer Pointer)..... 213</p> <p style="padding-left: 20px;">CiBUFNT2 (ECAN Filter 4-7 Buffer Pointer)..... 214</p> <p style="padding-left: 20px;">CiBUFNT3 (ECAN Filter 8-11 Buffer Pointer)..... 214</p> <p style="padding-left: 20px;">CiBUFNT4 (ECAN Filter 12-15 Buffer Pointer)..... 215</p> <p style="padding-left: 20px;">CiCFG1 (ECAN Baud Rate Configuration 1) 211</p> <p style="padding-left: 20px;">CiCFG2 (ECAN Baud Rate Configuration 2) 212</p> <p style="padding-left: 20px;">CiCTRL1 (ECAN Control 1) 204</p> <p style="padding-left: 20px;">CiCTRL2 (ECAN Control 2) 205</p> <p style="padding-left: 20px;">CiEC (ECAN Transmit/Receive Error Count)..... 211</p> <p style="padding-left: 20px;">CiFCTRL (ECAN FIFO Control)..... 207</p> <p style="padding-left: 20px;">CiFEN1 (ECAN Acceptance Filter Enable) 213</p> <p style="padding-left: 20px;">CiFIFO (ECAN FIFO Status)..... 208</p> <p style="padding-left: 20px;">CiFMSKSEL1 (ECAN Filter 7-0 Mask Selection)..... 217, 218</p> <p style="padding-left: 20px;">CiIINTE (ECAN Interrupt Enable) 210</p> <p style="padding-left: 20px;">CiIINTF (ECAN Interrupt Flag)..... 209</p> <p style="padding-left: 20px;">CiRXFnEID (ECAN Acceptance Filter n</p> <p style="padding-left: 40px;">Extended Identifier)..... 217</p> <p style="padding-left: 20px;">CiRXFnSID (ECAN Acceptance Filter n</p> <p style="padding-left: 40px;">Standard Identifier) 216</p> <p style="padding-left: 20px;">CiRXFUL1 (ECAN Receive Buffer Full 1) 220</p> <p style="padding-left: 20px;">CiRXFUL2 (ECAN Receive Buffer Full 2) 220</p> <p style="padding-left: 20px;">CiRXMnEID (ECAN Acceptance Filter Mask n</p>	<p style="padding-left: 40px;">Extended Identifier) 219</p> <p style="padding-left: 20px;">CiRXMnSID (ECAN Acceptance Filter Mask n</p> <p style="padding-left: 40px;">Standard Identifier)..... 219</p> <p style="padding-left: 20px;">CiRXOVF1 (ECAN Receive Buffer Overflow 1)..... 221</p> <p style="padding-left: 20px;">CiRXOVF2 (ECAN Receive Buffer Overflow 2)..... 221</p> <p style="padding-left: 20px;">CiTRBnSID (ECAN Buffer n Standard Identifier)..... 223, 224, 226</p> <p style="padding-left: 20px;">CiTRmnCON (ECAN TX/RX Buffer m Control) 222</p> <p style="padding-left: 20px;">CiVEC (ECAN Interrupt Code) 206</p> <p style="padding-left: 20px;">CLKDIV (Clock Divisor) 125</p> <p style="padding-left: 20px;">CORCON (Core Control)..... 22, 74</p> <p style="padding-left: 20px;">DMACS0 (DMA Controller Status 0) 114</p> <p style="padding-left: 20px;">DMACS1 (DMA Controller Status 1) 116</p> <p style="padding-left: 20px;">DMAxCNT (DMA Channel x Transfer Count)..... 113</p> <p style="padding-left: 20px;">DMAxCON (DMA Channel x Control)..... 110</p> <p style="padding-left: 20px;">DMAxPAD (DMA Channel x Peripheral Address) 113</p> <p style="padding-left: 20px;">DMAxREQ (DMA Channel x IRQ Select) 111</p> <p style="padding-left: 20px;">DMAxSTA (DMA Channel x RAM Start Address A) . 112</p> <p style="padding-left: 20px;">DMAxSTB (DMA Channel x RAM Start Address B) . 112</p> <p style="padding-left: 20px;">DSADR (Most Recent DMA RAM Address) 117</p> <p style="padding-left: 20px;">I2CxCON (I2Cx Control)..... 188</p> <p style="padding-left: 20px;">I2CxMSK (I2Cx Slave Mode Address Mask)..... 192</p> <p style="padding-left: 20px;">I2CxSTAT (I2Cx Status)..... 190</p> <p style="padding-left: 20px;">IFS0 (Interrupt Flag Status 0)..... 77, 84</p> <p style="padding-left: 20px;">IFS1 (Interrupt Flag Status 1) 79, 86</p> <p style="padding-left: 20px;">IFS2 (Interrupt Flag Status 2) 81, 88</p> <p style="padding-left: 20px;">IFS3 (Interrupt Flag Status 3) 82, 89</p> <p style="padding-left: 20px;">IFS4 (Interrupt Flag Status 4) 83, 90</p> <p style="padding-left: 20px;">INTCON1 (Interrupt Control 1) 75</p> <p style="padding-left: 20px;">INTCON2 (Interrupt Control 2) 76</p> <p style="padding-left: 20px;">INTTREG Interrupt Control and Status Register 105</p> <p style="padding-left: 20px;">IPC0 (Interrupt Priority Control 0)..... 91</p> <p style="padding-left: 20px;">IPC1 (Interrupt Priority Control 1) 92</p> <p style="padding-left: 20px;">IPC11 (Interrupt Priority Control 11)..... 101</p> <p style="padding-left: 20px;">IPC15 (Interrupt Priority Control 15)..... 102</p> <p style="padding-left: 20px;">IPC16 (Interrupt Priority Control 16)..... 103</p> <p style="padding-left: 20px;">IPC17 (Interrupt Priority Control 17)..... 104</p> <p style="padding-left: 20px;">IPC2 (Interrupt Priority Control 2)..... 93</p> <p style="padding-left: 20px;">IPC3 (Interrupt Priority Control 3)..... 94</p> <p style="padding-left: 20px;">IPC4 (Interrupt Priority Control 4)..... 95</p> <p style="padding-left: 20px;">IPC5 (Interrupt Priority Control 5)..... 96</p> <p style="padding-left: 20px;">IPC6 (Interrupt Priority Control 6)..... 97</p> <p style="padding-left: 20px;">IPC7 (Interrupt Priority Control 7)..... 98</p> <p style="padding-left: 20px;">IPC8 (Interrupt Priority Control 8)..... 99</p> <p style="padding-left: 20px;">IPC9 (Interrupt Priority Control 9) 100</p> <p style="padding-left: 20px;">NVMCON (Flash Memory Control)..... 55</p> <p style="padding-left: 20px;">NVMKEY (Nonvolatile Memory Key) 56</p> <p style="padding-left: 20px;">OCxCON (Output Compare x Control) 178</p> <p style="padding-left: 20px;">OSCCON (Oscillator Control)..... 123</p> <p style="padding-left: 20px;">OSCTUN (FRC Oscillator Tuning)..... 127</p> <p style="padding-left: 20px;">PLLFBDB (PLL Feedback Divisor) 126</p> <p style="padding-left: 20px;">PMD1 (Peripheral Module Disable</p> <p style="padding-left: 40px;">Control Register 1) 132</p> <p style="padding-left: 20px;">PMD2 (Peripheral Module Disable</p> <p style="padding-left: 40px;">Control Register 2) 133</p> <p style="padding-left: 20px;">PMD3 (Peripheral Module Disable</p> <p style="padding-left: 40px;">Control Register 3) 134</p> <p style="padding-left: 20px;">RCON (Reset Control)..... 61</p> <p style="padding-left: 20px;">SPiXCON1 (SPiX Control 1) 182</p> <p style="padding-left: 20px;">SPiXCON2 (SPiX Control 2) 184</p> <p style="padding-left: 20px;">SPiXSTAT (SPiX Status and Control) 181</p> <p style="padding-left: 20px;">SR (CPU Status) 21, 74</p> <p style="padding-left: 20px;">T1CON (Timer1 Control) 163</p> <p style="padding-left: 20px;">TCxCON (Input Capture x Control) 173</p> <p style="padding-left: 20px;">TxCON (Type B Time Base Control)..... 168</p> <p style="padding-left: 20px;">TyCON (Type C Time Base Control)..... 169</p> <p style="padding-left: 20px;">UxMODE (UARTx Mode) 195</p>
---	---

PIC24HJ32GP302/304, PIC24HJ64GPX02/X04 AND PIC24HJ128GPX02/X04

UxSTA (UARTx Status and Control).....	197	Input Capture (CAPx)	314
Reset		OC/PWM.....	315
Illegal Opcode	59, 67	Output Compare (OCx).....	314
Trap Conflict.....	66, 67	Reset, Watchdog Timer, Oscillator Start-up Timer and Power-up Timer	310
Uninitialized W Register.....	59, 67	Timer1, 2 and 3 External Clock	312
Reset Sequence.....	69	Timing Requirements	
Resets	59	ADC Conversion (10-bit mode).....	353
S		ADC Conversion (12-bit Mode).....	353
Serial Peripheral Interface (SPI)	179	CLKO and I/O	309
Software Reset Instruction (SWR)	66	External Clock.....	307
Software Simulator (MPLAB SIM).....	293	Input Capture.....	314
Software Stack Pointer, Frame Pointer		SPIx Master Mode (CKE = 0)	349
CALLL Stack Frame.....	47	SPIx Module Master Mode (CKE = 1)	349
Special Features of the CPU.....	273	SPIx Module Slave Mode (CKE = 0)	350
SPI Module		SPIx Module Slave Mode (CKE = 1)	350
SPI1 Register Map	35	Timing Specifications	
Symbols Used in Opcode Descriptions.....	284	10-bit A/D Conversion Requirements	339
System Control		12-bit A/D Conversion Requirements	337
Register Map.....	45, 46	CAN I/O Requirements	332
T		I2Cx Bus Data Requirements (Master Mode).....	329
Temperature and Voltage Specifications		I2Cx Bus Data Requirements (Slave Mode).....	331
AC	306, 348	Output Compare Requirements.....	314
Timer1	161	PLL Clock	308, 348
Timer2/3	165	Reset, Watchdog Timer, Oscillator Start-up Timer, Power-up Timer and Brown-out Reset Requirements	311
Timing Characteristics		Simple OC/PWM Mode Requirements	315
CLKO and I/O	309	Timer1 External Clock Requirements	312
Timing Diagrams		Timer2 External Clock Requirements	313
10-bit A/D Conversion (CHPS<1:0> = 01, SIMSAM = 0, ASAM = 0, SSRC<2:0> = 000)	338	Timer3 External Clock Requirements	313
10-bit A/D Conversion (CHPS<1:0> = 01, SIMSAM = 0, ASAM = 1, SSRC<2:0> = 111, SAMC<4:0> = 00001).....	338	U	
10-bit A/D Conversion (CHPS<1:0> = 01, SIMSAM = 0, ASAM = 1, SSRC<2:0> = 111, SAMC<4:0> = 00001)	338	UART Module	
12-bit A/D Conversion (ASAM = 0, SSRC<2:0> = 000).....	336	UART1 Register Map.....	34, 35
Brown-out Situations	66	Universal Asynchronous Receiver Transmitter (UART) ...	193
ECAN I/O	332	Using the RCON Status Bits	67
External Clock.....	307	V	
I2Cx Bus Data (Master Mode)	328	Voltage Regulator (On-Chip)	277
I2Cx Bus Data (Slave Mode)	330	W	
I2Cx Bus Start/Stop Bits (Master Mode)	328	Watchdog Time-out Reset (WDTR).....	66
I2Cx Bus Start/Stop Bits (Slave Mode)	330	Watchdog Timer (WDT).....	273, 278
		Programming Considerations	278
		WWW Address	387
		WWW, On-Line Support	3

THE MICROCHIP WEB SITE

Microchip provides online support via our WWW site at www.microchip.com. This web site is used as a means to make files and information easily available to customers. Accessible by using your favorite Internet browser, the web site contains the following information:

- **Product Support** – Data sheets and errata, application notes and sample programs, design resources, user's guides and hardware support documents, latest software releases and archived software
- **General Technical Support** – Frequently Asked Questions (FAQs), technical support requests, online discussion groups, Microchip consultant program member listing
- **Business of Microchip** – Product selector and ordering guides, latest Microchip press releases, listing of seminars and events, listings of Microchip sales offices, distributors and factory representatives

CUSTOMER CHANGE NOTIFICATION SERVICE

Microchip's customer notification service helps keep customers current on Microchip products. Subscribers will receive e-mail notification whenever there are changes, updates, revisions or errata related to a specified product family or development tool of interest.

To register, access the Microchip web site at www.microchip.com. Under "Support", click on "Customer Change Notification" and follow the registration instructions.

CUSTOMER SUPPORT

Users of Microchip products can receive assistance through several channels:

- Distributor or Representative
- Local Sales Office
- Field Application Engineer (FAE)
- Technical Support
- Development Systems Information Line

Customers should contact their distributor, representative or field application engineer (FAE) for support. Local sales offices are also available to help customers. A listing of sales offices and locations is included in the back of this document.

Technical support is available through the web site at: <http://microchip.com/support>

READER RESPONSE

It is our intention to provide you with the best documentation possible to ensure successful use of your Microchip product. If you wish to provide your comments on organization, clarity, subject matter, and ways in which our documentation can better serve you, please FAX your comments to the Technical Publications Manager at (480) 792-4150.

Please list the following information, and use this outline to provide us with your comments about this document.

TO: Technical Publications Manager Total Pages Sent _____

RE: Reader Response

From: Name _____

Company _____

Address _____

City / State / ZIP / Country _____

Telephone: (_____) _____ - _____ FAX: (_____) _____ - _____

Application (optional):

Would you like a reply? ___Y___N

Device: PIC24HJ32GP302/304, PIC24HJ64GPX02/X04 and
PIC24HJ128GPX02/X04

Literature Number: DS70293G

Questions:

1. What are the best features of this document?

2. How does this document meet your hardware and software development needs?

3. Do you find the organization of this document easy to follow? If not, why?

4. What additions to the document do you think would enhance the structure and subject?

5. What deletions from the document could be made without affecting the overall usefulness?

6. Is there any incorrect or misleading information (what and where)?

7. How would you improve this document?

PRODUCT IDENTIFICATION SYSTEM

To order or obtain information, e.g., on pricing or delivery, refer to the factory or the listed sales office.

<p style="text-align: center;">PIC 24 HJ 32 GP3 02 T E / SP - XXX</p> <p>Microchip Trademark _____</p> <p>Architecture _____</p> <p>Flash Memory Family _____</p> <p>Program Memory Size (KB) _____</p> <p>Product Group _____</p> <p>Pin Count _____</p> <p>Tape and Reel Flag (if applicable) _____</p> <p>Temperature Range _____</p> <p>Package _____</p> <p>Pattern _____</p>	<p>Examples:</p> <p>a) PIC24HJ32GP302-E/SP: General Purpose PIC24H, 32 KB program memory, 28-pin, Extended temperature, SPDIP package.</p>																																																												
<table border="1" style="width: 100%; border-collapse: collapse;"> <tr> <td style="width: 15%;">Architecture:</td> <td style="width: 10%;">24</td> <td style="width: 10%;">=</td> <td>16-bit Microcontroller</td> </tr> <tr> <td>Flash Memory Family:</td> <td>HJ</td> <td>=</td> <td>Flash program memory, 3.3V</td> </tr> <tr> <td>Product Group:</td> <td>GP2</td> <td>=</td> <td>General Purpose family</td> </tr> <tr> <td></td> <td>GP3</td> <td>=</td> <td>General Purpose family</td> </tr> <tr> <td></td> <td>GP8</td> <td>=</td> <td>General Purpose family</td> </tr> <tr> <td>Pin Count:</td> <td>02</td> <td>=</td> <td>28-pin</td> </tr> <tr> <td></td> <td>04</td> <td>=</td> <td>44-pin</td> </tr> <tr> <td>Temperature Range:</td> <td>I</td> <td>=</td> <td>-40° C to+85° C (Industrial)</td> </tr> <tr> <td></td> <td>E</td> <td>=</td> <td>-40° C to+125° C (Extended)</td> </tr> <tr> <td></td> <td>H</td> <td>=</td> <td>-40° C to+150° C (High)</td> </tr> <tr> <td>Package:</td> <td>SP</td> <td>=</td> <td>Skinny Plastic Dual In-Line - 300 mil body (SPDIP)</td> </tr> <tr> <td></td> <td>SO</td> <td>=</td> <td>Plastic Small Outline - Wide - 300 mil body (SOIC)</td> </tr> <tr> <td></td> <td>ML</td> <td>=</td> <td>Plastic Quad, No Lead Package - 8x8 mm body (QFN)</td> </tr> <tr> <td></td> <td>MM</td> <td>=</td> <td>Plastic Quad, No Lead Package - 6x6x0.9 mm body (QFN-S)</td> </tr> <tr> <td></td> <td>PT</td> <td>=</td> <td>Plastic Thin Quad Flatpack - 10x10x1 mm body (TQFP)</td> </tr> </table>		Architecture:	24	=	16-bit Microcontroller	Flash Memory Family:	HJ	=	Flash program memory, 3.3V	Product Group:	GP2	=	General Purpose family		GP3	=	General Purpose family		GP8	=	General Purpose family	Pin Count:	02	=	28-pin		04	=	44-pin	Temperature Range:	I	=	-40° C to+85° C (Industrial)		E	=	-40° C to+125° C (Extended)		H	=	-40° C to+150° C (High)	Package:	SP	=	Skinny Plastic Dual In-Line - 300 mil body (SPDIP)		SO	=	Plastic Small Outline - Wide - 300 mil body (SOIC)		ML	=	Plastic Quad, No Lead Package - 8x8 mm body (QFN)		MM	=	Plastic Quad, No Lead Package - 6x6x0.9 mm body (QFN-S)		PT	=	Plastic Thin Quad Flatpack - 10x10x1 mm body (TQFP)
Architecture:	24	=	16-bit Microcontroller																																																										
Flash Memory Family:	HJ	=	Flash program memory, 3.3V																																																										
Product Group:	GP2	=	General Purpose family																																																										
	GP3	=	General Purpose family																																																										
	GP8	=	General Purpose family																																																										
Pin Count:	02	=	28-pin																																																										
	04	=	44-pin																																																										
Temperature Range:	I	=	-40° C to+85° C (Industrial)																																																										
	E	=	-40° C to+125° C (Extended)																																																										
	H	=	-40° C to+150° C (High)																																																										
Package:	SP	=	Skinny Plastic Dual In-Line - 300 mil body (SPDIP)																																																										
	SO	=	Plastic Small Outline - Wide - 300 mil body (SOIC)																																																										
	ML	=	Plastic Quad, No Lead Package - 8x8 mm body (QFN)																																																										
	MM	=	Plastic Quad, No Lead Package - 6x6x0.9 mm body (QFN-S)																																																										
	PT	=	Plastic Thin Quad Flatpack - 10x10x1 mm body (TQFP)																																																										

NOTES:

Note the following details of the code protection feature on Microchip devices:

- Microchip products meet the specification contained in their particular Microchip Data Sheet.
- Microchip believes that its family of products is one of the most secure families of its kind on the market today, when used in the intended manner and under normal conditions.
- There are dishonest and possibly illegal methods used to breach the code protection feature. All of these methods, to our knowledge, require using the Microchip products in a manner outside the operating specifications contained in Microchip's Data Sheets. Most likely, the person doing so is engaged in theft of intellectual property.
- Microchip is willing to work with the customer who is concerned about the integrity of their code.
- Neither Microchip nor any other semiconductor manufacturer can guarantee the security of their code. Code protection does not mean that we are guaranteeing the product as “unbreakable.”

Code protection is constantly evolving. We at Microchip are committed to continuously improving the code protection features of our products. Attempts to break Microchip's code protection feature may be a violation of the Digital Millennium Copyright Act. If such acts allow unauthorized access to your software or other copyrighted work, you may have a right to sue for relief under that Act.

Information contained in this publication regarding device applications and the like is provided only for your convenience and may be superseded by updates. It is your responsibility to ensure that your application meets with your specifications. MICROCHIP MAKES NO REPRESENTATIONS OR WARRANTIES OF ANY KIND WHETHER EXPRESS OR IMPLIED, WRITTEN OR ORAL, STATUTORY OR OTHERWISE, RELATED TO THE INFORMATION, INCLUDING BUT NOT LIMITED TO ITS CONDITION, QUALITY, PERFORMANCE, MERCHANTABILITY OR FITNESS FOR PURPOSE. Microchip disclaims all liability arising from this information and its use. Use of Microchip devices in life support and/or safety applications is entirely at the buyer's risk, and the buyer agrees to defend, indemnify and hold harmless Microchip from any and all damages, claims, suits, or expenses resulting from such use. No licenses are conveyed, implicitly or otherwise, under any Microchip intellectual property rights.

Trademarks

The Microchip name and logo, the Microchip logo, dsPIC, KEELOQ, KEELOQ logo, MPLAB, PIC, PICmicro, PICSTART, PIC³² logo, rPIC and UNI/O are registered trademarks of Microchip Technology Incorporated in the U.S.A. and other countries.

FilterLab, Hampshire, HI-TECH C, Linear Active Thermistor, MXDEV, MXLAB, SEEVAL and The Embedded Control Solutions Company are registered trademarks of Microchip Technology Incorporated in the U.S.A.

Analog-for-the-Digital Age, Application Maestro, chipKIT, chipKIT logo, CodeGuard, dsPICDEM, dsPICDEM.net, dsPICworks, dsSPEAK, ECAN, ECONOMONITOR, FanSense, HI-TIDE, In-Circuit Serial Programming, ICSP, Mindi, MiWi, MPASM, MPLAB Certified logo, MPLIB, MPLINK, mTouch, Omniscient Code Generation, PICC, PICC-18, PICDEM, PICDEM.net, PICKit, PICtail, REAL ICE, rLAB, Select Mode, Total Endurance, TSHARC, UniWinDriver, WiperLock and ZENA are trademarks of Microchip Technology Incorporated in the U.S.A. and other countries.

SQTP is a service mark of Microchip Technology Incorporated in the U.S.A.

All other trademarks mentioned herein are property of their respective companies.

© 2007-2012, Microchip Technology Incorporated, Printed in the U.S.A., All Rights Reserved.

 Printed on recycled paper.

ISBN: 978-1-62076-238-7

**QUALITY MANAGEMENT SYSTEM
CERTIFIED BY DNV
= ISO/TS 16949 =**

Microchip received ISO/TS-16949:2009 certification for its worldwide headquarters, design and wafer fabrication facilities in Chandler and Tempe, Arizona; Gresham, Oregon and design centers in California and India. The Company's quality system processes and procedures are for its PIC[®] MCUs and dsPIC[®] DSCs, KEELOQ[®] code hopping devices, Serial EEPROMs, microperipherals, nonvolatile memory and analog products. In addition, Microchip's quality system for the design and manufacture of development systems is ISO 9001:2000 certified.



MICROCHIP

Worldwide Sales and Service

AMERICAS

Corporate Office
2355 West Chandler Blvd.
Chandler, AZ 85224-6199
Tel: 480-792-7200
Fax: 480-792-7277
Technical Support:
<http://www.microchip.com/support>
Web Address:
www.microchip.com

Atlanta
Duluth, GA
Tel: 678-957-9614
Fax: 678-957-1455

Boston
Westborough, MA
Tel: 774-760-0087
Fax: 774-760-0088

Chicago
Itasca, IL
Tel: 630-285-0071
Fax: 630-285-0075

Cleveland
Independence, OH
Tel: 216-447-0464
Fax: 216-447-0643

Dallas
Addison, TX
Tel: 972-818-7423
Fax: 972-818-2924

Detroit
Farmington Hills, MI
Tel: 248-538-2250
Fax: 248-538-2260

Indianapolis
Noblesville, IN
Tel: 317-773-8323
Fax: 317-773-5453

Los Angeles
Mission Viejo, CA
Tel: 949-462-9523
Fax: 949-462-9608

Santa Clara
Santa Clara, CA
Tel: 408-961-6444
Fax: 408-961-6445

Toronto
Mississauga, Ontario,
Canada
Tel: 905-673-0699
Fax: 905-673-6509

ASIA/PACIFIC

Asia Pacific Office
Suites 3707-14, 37th Floor
Tower 6, The Gateway
Harbour City, Kowloon
Hong Kong
Tel: 852-2401-1200
Fax: 852-2401-3431

Australia - Sydney
Tel: 61-2-9868-6733
Fax: 61-2-9868-6755

China - Beijing
Tel: 86-10-8569-7000
Fax: 86-10-8528-2104

China - Chengdu
Tel: 86-28-8665-5511
Fax: 86-28-8665-7889

China - Chongqing
Tel: 86-23-8980-9588
Fax: 86-23-8980-9500

China - Hangzhou
Tel: 86-571-2819-3187
Fax: 86-571-2819-3189

China - Hong Kong SAR
Tel: 852-2401-1200
Fax: 852-2401-3431

China - Nanjing
Tel: 86-25-8473-2460
Fax: 86-25-8473-2470

China - Qingdao
Tel: 86-532-8502-7355
Fax: 86-532-8502-7205

China - Shanghai
Tel: 86-21-5407-5533
Fax: 86-21-5407-5066

China - Shenyang
Tel: 86-24-2334-2829
Fax: 86-24-2334-2393

China - Shenzhen
Tel: 86-755-8203-2660
Fax: 86-755-8203-1760

China - Wuhan
Tel: 86-27-5980-5300
Fax: 86-27-5980-5118

China - Xian
Tel: 86-29-8833-7252
Fax: 86-29-8833-7256

China - Xiamen
Tel: 86-592-2388138
Fax: 86-592-2388130

China - Zhuhai
Tel: 86-756-3210040
Fax: 86-756-3210049

ASIA/PACIFIC

India - Bangalore
Tel: 91-80-3090-4444
Fax: 91-80-3090-4123

India - New Delhi
Tel: 91-11-4160-8631
Fax: 91-11-4160-8632

India - Pune
Tel: 91-20-2566-1512
Fax: 91-20-2566-1513

Japan - Osaka
Tel: 81-66-152-7160
Fax: 81-66-152-9310

Japan - Yokohama
Tel: 81-45-471-6166
Fax: 81-45-471-6122

Korea - Daegu
Tel: 82-53-744-4301
Fax: 82-53-744-4302

Korea - Seoul
Tel: 82-2-554-7200
Fax: 82-2-558-5932 or
82-2-558-5934

Malaysia - Kuala Lumpur
Tel: 60-3-6201-9857
Fax: 60-3-6201-9859

Malaysia - Penang
Tel: 60-4-227-8870
Fax: 60-4-227-4068

Philippines - Manila
Tel: 63-2-634-9065
Fax: 63-2-634-9069

Singapore
Tel: 65-6334-8870
Fax: 65-6334-8850

Taiwan - Hsin Chu
Tel: 886-3-5778-366
Fax: 886-3-5770-955

Taiwan - Kaohsiung
Tel: 886-7-536-4818
Fax: 886-7-330-9305

Taiwan - Taipei
Tel: 886-2-2500-6610
Fax: 886-2-2508-0102

Thailand - Bangkok
Tel: 66-2-694-1351
Fax: 66-2-694-1350

EUROPE

Austria - Wels
Tel: 43-7242-2244-39
Fax: 43-7242-2244-393

Denmark - Copenhagen
Tel: 45-4450-2828
Fax: 45-4485-2829

France - Paris
Tel: 33-1-69-53-63-20
Fax: 33-1-69-30-90-79

Germany - Munich
Tel: 49-89-627-144-0
Fax: 49-89-627-144-44

Italy - Milan
Tel: 39-0331-742611
Fax: 39-0331-466781

Netherlands - Drunen
Tel: 31-416-690399
Fax: 31-416-690340

Spain - Madrid
Tel: 34-91-708-08-90
Fax: 34-91-708-08-91

UK - Wokingham
Tel: 44-118-921-5869
Fax: 44-118-921-5820

11/29/11



Стандарт Электрон Связь

Мы молодая и активно развивающаяся компания в области поставок электронных компонентов. Мы поставляем электронные компоненты отечественного и импортного производства напрямую от производителей и с крупнейших складов мира.

Благодаря сотрудничеству с мировыми поставщиками мы осуществляем комплексные и плановые поставки широчайшего спектра электронных компонентов.

Собственная эффективная логистика и склад в обеспечивает надежную поставку продукции в точно указанные сроки по всей России.

Мы осуществляем техническую поддержку нашим клиентам и предпродажную проверку качества продукции. На все поставляемые продукты мы предоставляем гарантию .

Осуществляем поставки продукции под контролем ВП МО РФ на предприятия военно-промышленного комплекса России , а также работаем в рамках 275 ФЗ с открытием отдельных счетов в уполномоченном банке. Система менеджмента качества компании соответствует требованиям ГОСТ ISO 9001.

Минимальные сроки поставки, гибкие цены, неограниченный ассортимент и индивидуальный подход к клиентам являются основой для выстраивания долгосрочного и эффективного сотрудничества с предприятиями радиоэлектронной промышленности, предприятиями ВПК и научно-исследовательскими институтами России.

С нами вы становитесь еще успешнее!

Наши контакты:

Телефон: +7 812 627 14 35

Электронная почта: sales@st-electron.ru

Адрес: 198099, Санкт-Петербург,
Промышленная ул, дом № 19, литера Н,
помещение 100-Н Офис 331