

Schottky Barrier Diode

CRS15I30B

1. Applications

- Secondary Rectification in Switching Regulators
- Reverse-Current Protection in Mobile Devices

2. Features

- (1) Peak forward voltage: $V_{FM} = 0.4 \text{ V (max) @ } I_{FM} = 1.5 \text{ A}$
- (2) Average forward current: $I_{F(AV)} = 1.5 \text{ A}$
- (3) Repetitive peak reverse voltage: $V_{RRM} = 30 \text{ V}$
- (4) Small, thin package suitable for high-density board assembly
Toshiba Nickname: S-FLAT™

3. Packaging and Internal Circuit

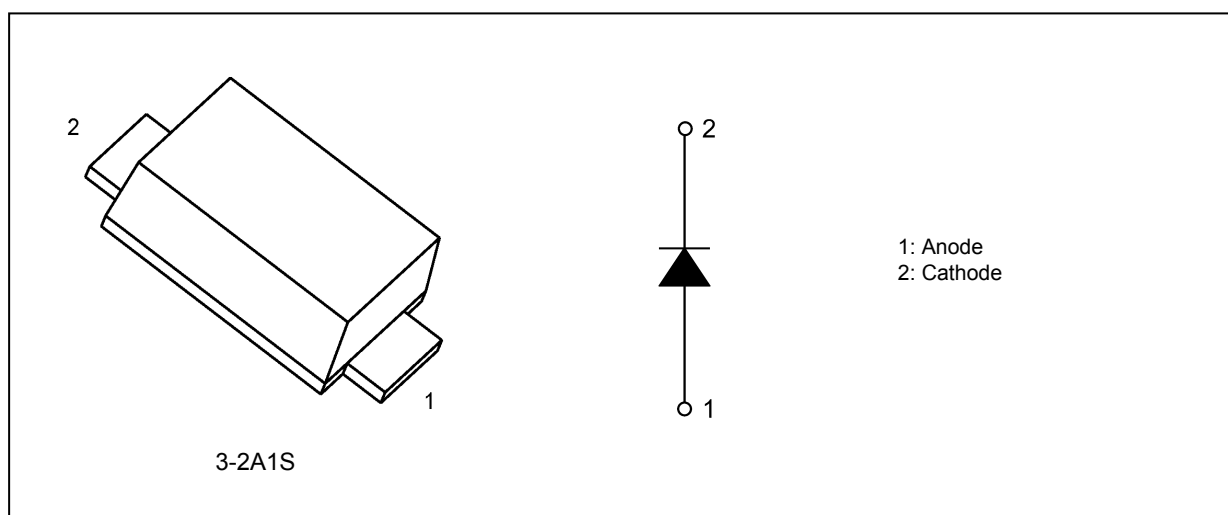

4. Absolute Maximum Ratings (Note) (Unless otherwise specified, $T_a = 25 \text{ }^\circ\text{C}$)

Characteristics	Symbol	Note	Rating	Unit
Repetitive peak reverse voltage	V_{RRM}		30	V
Average forward current	$I_{F(AV)}$	(Note 1)	1.5	A
Non-repetitive peak forward surge current	I_{FSM}	(Note 2)	30	
Junction temperature	T_j		150	$^\circ\text{C}$
Storage temperature	T_{stg}		-55 to 150	

Note: Using continuously under heavy loads (e.g. the application of high temperature/current/voltage and the significant change in temperature, etc.) may cause this product to decrease in the reliability significantly even if the operating conditions (i.e. operating temperature/current/voltage, etc.) are within the absolute maximum ratings.

Please design the appropriate reliability upon reviewing the Toshiba Semiconductor Reliability Handbook ("Handling Precautions"/"Derating Concept and Methods") and individual reliability data (i.e. reliability test report and estimated failure rate, etc).

Note 1: $T_l = 116 \text{ }^\circ\text{C}$, square wave ($\alpha = 180^\circ$), $V_R = 15 \text{ V}$

Note 2: $f = 50 \text{ Hz}$, half-sine wave

Start of commercial production

2010-10

5. Thermal Characteristics

Characteristics	Symbol	Note	Test Condition	Max	Unit
Thermal resistance (junction-to-ambient)	$R_{th(j-a)}$		Device mounted on a ceramic board (board size: 50 mm × 50 mm) (soldering land size: 2 mm × 2 mm) (board thickness: 0.64 mm)	70	°C/W
			Device mounted on a glass-epoxy board (board size: 50 mm × 50 mm) (soldering land size: 6 mm × 6 mm) (board thickness: 1.6 mm)	140	
Thermal resistance (junction-to-lead)	$R_{th(j-l)}$		Junction to cathode lead	20	°C/W

6. Electrical Characteristics (Unless otherwise specified, $T_a = 25\text{ °C}$)

Characteristics	Symbol	Note	Test Condition	Min	Typ.	Max	Unit
Peak forward voltage	$V_{FM(1)}$		$I_{FM} = 0.1\text{ A}$ (pulse measurement)	—	0.25	—	V
	$V_{FM(2)}$		$I_{FM} = 1.0\text{ A}$ (pulse measurement)	—	0.33	—	
	$V_{FM(3)}$		$I_{FM} = 1.5\text{ A}$ (pulse measurement)	—	0.34	0.40	
Repetitive peak reverse current	$I_{RRM(1)}$		$V_{RRM} = 5\text{ V}$ (pulse measurement)	—	14	—	μA
	$I_{RRM(2)}$		$V_{RRM} = 30\text{ V}$ (pulse measurement)	—	28	100	
Junction capacitance	C_j		$V_R = 10\text{ V}$, $f = 1\text{ MHz}$	—	82	—	pF

7. Marking

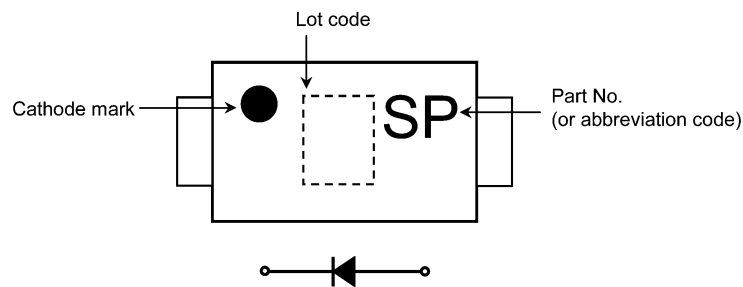

Fig. 7.1 Marking

Marking Code	Part Number
SP	CRS15I30B

8. Usage Considerations

- (1) Schottky barrier diodes (SBDs) have reverse current greater than other types of diodes. This makes SBDs more vulnerable to damage due to thermal runaway under high-temperature and high-voltage conditions. Thus, both forward and reverse power losses of SBDs should be considered for thermal and safety design.
- (2) The absolute maximum ratings are rated values that must not be exceeded during operation, even for an instant. The following are the recommended general derating methods for designing a circuit board using this device.

V_{RRM} : Use this rating with reference to (1) above. V_{RRM} has a temperature coefficient of 0.1 %/°C at low temperatures. Take this coefficient into account when designing a circuit board that will be operated in a low-temperature environment.

$I_{F(AV)}$: We recommend that the worst-case current be no greater than 80 % of the absolute maximum rating of $I_{F(AV)}$ and that the worst-case junction temperature, T_j , be kept below 120 °C. When using this device, allow margins, referring to the $T_{a(max)}-I_{F(AV)}$ curve.

I_{FSM} : This rating specifies peak non-repetitive forward surge current. This only applies to an abnormal operation, which seldom occurs during the lifespan of a device.

T_j : Derate device parameters in proportion to this rating in order to ensure high reliability. We recommend that the junction temperature (T_j) of a device be kept below 120 °C.

- (3) Thermal resistance (junction-to-ambient) varies with the mounting conditions of a device on a circuit board. An appropriate thermal resistance value should be used, considering the heat sink, circuit board design and land pattern dimensions (provided for reference only).
- (4) For other design considerations, see the Rectifiers databook or the Toshiba Semiconductor website.

9. Land Pattern Dimensions (for reference only)

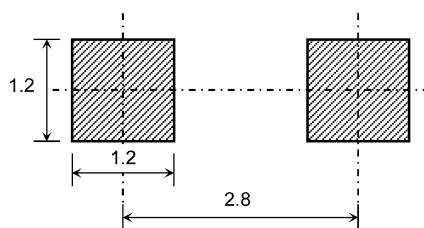

Fig. 9.1 Land Pattern Dimensions for Reference Only (Unit: mm)

10. Characteristics Curves (Note)

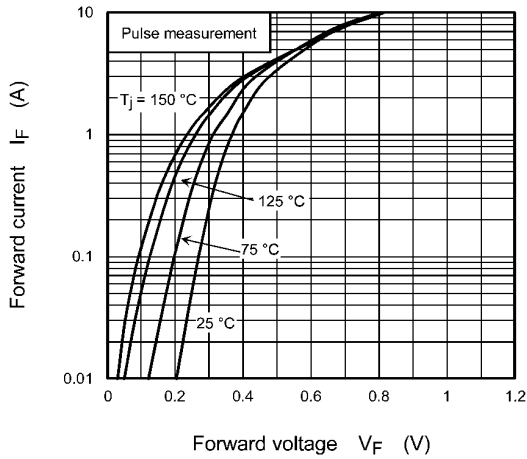

Fig. 10.1 $I_F - V_F$

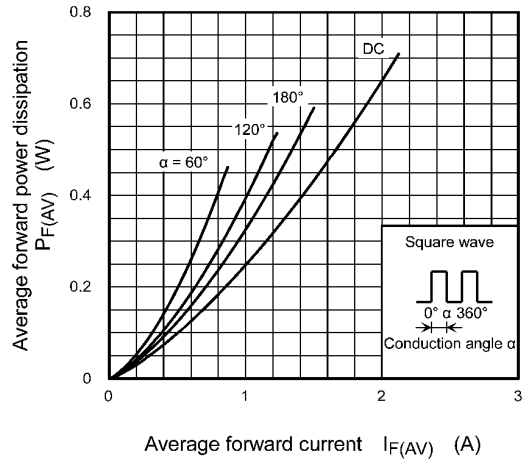

Fig. 10.2 $P_{F(AV)} - I_{F(AV)}$

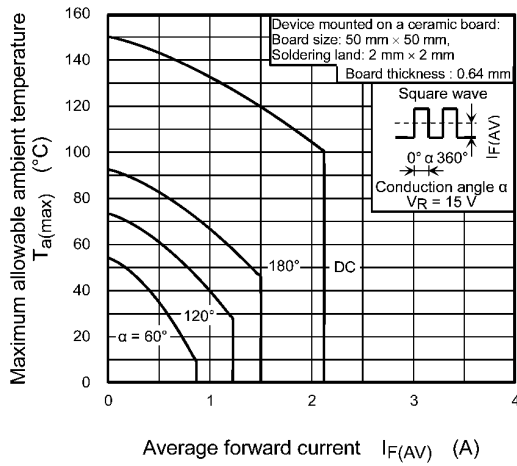

Fig. 10.3 $T_{a(max)} - I_{F(AV)}$

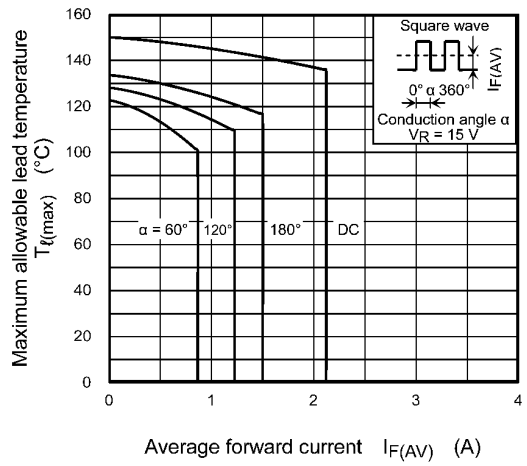

Fig. 10.4 $T_{l(max)} - I_{F(AV)}$

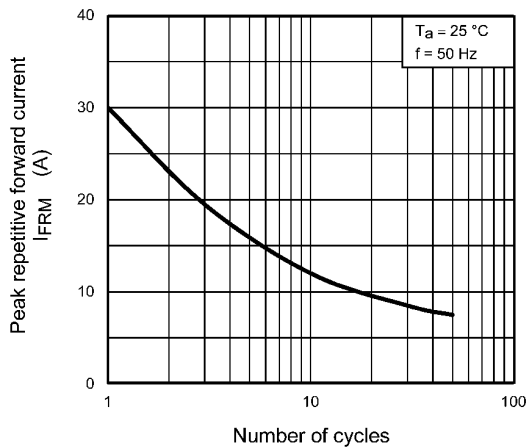

Fig. 10.5 Peak Repetitive Forward Current

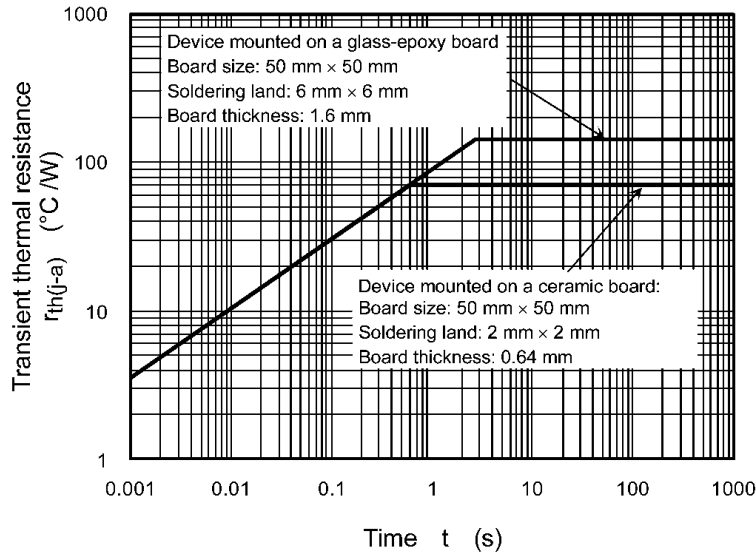

Fig. 10.6 $r_{th(j-a)} - t$

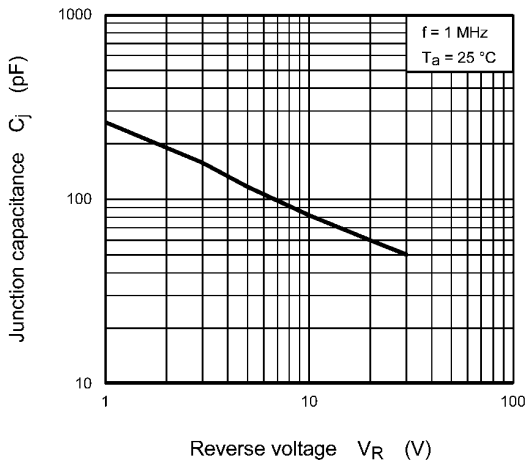

Fig. 10.7 $C_j - V_R$

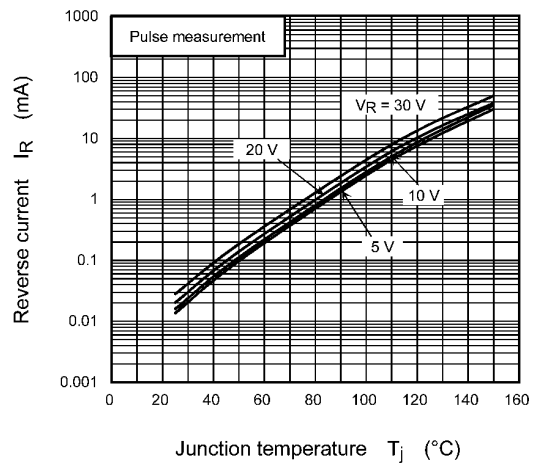

Fig. 10.8 $I_R - T_j$

Note: The above characteristics curves are presented for reference only and not guaranteed by production test, unless otherwise noted.

Package Dimensions

Unit: mm



Weight: 0.013 g (typ.)

Package Name(s)
TOSHIBA: 3-2A1S
Nickname: S-FLAT

RESTRICTIONS ON PRODUCT USE

- Toshiba Corporation, and its subsidiaries and affiliates (collectively "TOSHIBA"), reserve the right to make changes to the information in this document, and related hardware, software and systems (collectively "Product") without notice.
- This document and any information herein may not be reproduced without prior written permission from TOSHIBA. Even with TOSHIBA's written permission, reproduction is permissible only if reproduction is without alteration/omission.
- Though TOSHIBA works continually to improve Product's quality and reliability, Product can malfunction or fail. Customers are responsible for complying with safety standards and for providing adequate designs and safeguards for their hardware, software and systems which minimize risk and avoid situations in which a malfunction or failure of Product could cause loss of human life, bodily injury or damage to property, including data loss or corruption. Before customers use the Product, create designs including the Product, or incorporate the Product into their own applications, customers must also refer to and comply with (a) the latest versions of all relevant TOSHIBA information, including without limitation, this document, the specifications, the data sheets and application notes for Product and the precautions and conditions set forth in the "TOSHIBA Semiconductor Reliability Handbook" and (b) the instructions for the application with which the Product will be used with or for. Customers are solely responsible for all aspects of their own product design or applications, including but not limited to (a) determining the appropriateness of the use of this Product in such design or applications; (b) evaluating and determining the applicability of any information contained in this document, or in charts, diagrams, programs, algorithms, sample application circuits, or any other referenced documents; and (c) validating all operating parameters for such designs and applications. **TOSHIBA ASSUMES NO LIABILITY FOR CUSTOMERS' PRODUCT DESIGN OR APPLICATIONS.**
- **PRODUCT IS NEITHER INTENDED NOR WARRANTED FOR USE IN EQUIPMENTS OR SYSTEMS THAT REQUIRE EXTRAORDINARILY HIGH LEVELS OF QUALITY AND/OR RELIABILITY, AND/OR A MALFUNCTION OR FAILURE OF WHICH MAY CAUSE LOSS OF HUMAN LIFE, BODILY INJURY, SERIOUS PROPERTY DAMAGE AND/OR SERIOUS PUBLIC IMPACT ("UNINTENDED USE").** Except for specific applications as expressly stated in this document, Unintended Use includes, without limitation, equipment used in nuclear facilities, equipment used in the aerospace industry, medical equipment, equipment used for automobiles, trains, ships and other transportation, traffic signaling equipment, equipment used to control combustions or explosions, safety devices, elevators and escalators, devices related to electric power, and equipment used in finance-related fields. **IF YOU USE PRODUCT FOR UNINTENDED USE, TOSHIBA ASSUMES NO LIABILITY FOR PRODUCT.** For details, please contact your TOSHIBA sales representative.
- Do not disassemble, analyze, reverse-engineer, alter, modify, translate or copy Product, whether in whole or in part.
- Product shall not be used for or incorporated into any products or systems whose manufacture, use, or sale is prohibited under any applicable laws or regulations.
- The information contained herein is presented only as guidance for Product use. No responsibility is assumed by TOSHIBA for any infringement of patents or any other intellectual property rights of third parties that may result from the use of Product. No license to any intellectual property right is granted by this document, whether express or implied, by estoppel or otherwise.
- **ABSENT A WRITTEN SIGNED AGREEMENT, EXCEPT AS PROVIDED IN THE RELEVANT TERMS AND CONDITIONS OF SALE FOR PRODUCT, AND TO THE MAXIMUM EXTENT ALLOWABLE BY LAW, TOSHIBA (1) ASSUMES NO LIABILITY WHATSOEVER, INCLUDING WITHOUT LIMITATION, INDIRECT, CONSEQUENTIAL, SPECIAL, OR INCIDENTAL DAMAGES OR LOSS, INCLUDING WITHOUT LIMITATION, LOSS OF PROFITS, LOSS OF OPPORTUNITIES, BUSINESS INTERRUPTION AND LOSS OF DATA, AND (2) DISCLAIMS ANY AND ALL EXPRESS OR IMPLIED WARRANTIES AND CONDITIONS RELATED TO SALE, USE OF PRODUCT, OR INFORMATION, INCLUDING WARRANTIES OR CONDITIONS OF MERCHANTABILITY, FITNESS FOR A PARTICULAR PURPOSE, ACCURACY OF INFORMATION, OR NONINFRINGEMENT.**
- Do not use or otherwise make available Product or related software or technology for any military purposes, including without limitation, for the design, development, use, stockpiling or manufacturing of nuclear, chemical, or biological weapons or missile technology products (mass destruction weapons). Product and related software and technology may be controlled under the applicable export laws and regulations including, without limitation, the Japanese Foreign Exchange and Foreign Trade Law and the U.S. Export Administration Regulations. Export and re-export of Product or related software or technology are strictly prohibited except in compliance with all applicable export laws and regulations.
- Please contact your TOSHIBA sales representative for details as to environmental matters such as the RoHS compatibility of Product. Please use Product in compliance with all applicable laws and regulations that regulate the inclusion or use of controlled substances, including without limitation, the EU RoHS Directive. **TOSHIBA ASSUMES NO LIABILITY FOR DAMAGES OR LOSSES OCCURRING AS A RESULT OF NONCOMPLIANCE WITH APPLICABLE LAWS AND REGULATIONS.**



Стандарт Электрон Связь

Мы молодая и активно развивающаяся компания в области поставок электронных компонентов. Мы поставляем электронные компоненты отечественного и импортного производства напрямую от производителей и с крупнейших складов мира.

Благодаря сотрудничеству с мировыми поставщиками мы осуществляем комплексные и плановые поставки широчайшего спектра электронных компонентов.

Собственная эффективная логистика и склад в обеспечивает надежную поставку продукции в точно указанные сроки по всей России.

Мы осуществляем техническую поддержку нашим клиентам и предпродажную проверку качества продукции. На все поставляемые продукты мы предоставляем гарантию .

Осуществляем поставки продукции под контролем ВП МО РФ на предприятия военно-промышленного комплекса России , а также работаем в рамках 275 ФЗ с открытием отдельных счетов в уполномоченном банке. Система менеджмента качества компании соответствует требованиям ГОСТ ISO 9001.

Минимальные сроки поставки, гибкие цены, неограниченный ассортимент и индивидуальный подход к клиентам являются основой для выстраивания долгосрочного и эффективного сотрудничества с предприятиями радиоэлектронной промышленности, предприятиями ВПК и научно-исследовательскими институтами России.

С нами вы становитесь еще успешнее!

Наши контакты:

Телефон: +7 812 627 14 35

Электронная почта: sales@st-electron.ru

Адрес: 198099, Санкт-Петербург,
Промышленная ул, дом № 19, литера Н,
помещение 100-Н Офис 331