

AGASTAT 7000 Series, Industrial Electropneumatic Timing Relay



Product Facts

- Available in on-delay, true off-delay, and on/off-delay
- Timing from 0.1 seconds to 60 minutes, in linear increments
- Oversize adjustment knobs, serrated with high-resolution markings visible from all angles makes the timer easy to set timers
- Inherent transient immunity
- Standard voltages from 6-550VAC and 12-550VDC (special voltages available)
- Available in 2-pole or 4-pole models
- Numerous enclosure options — explosion proof, dust tight, watertight, hermetically-sealed, NEMA 1
- Auxiliary timed and instantaneous switches can be added for greater switching flexibility
- Many mounting options — Surface mount, Panel mount, Octal plug-in mounting
- Options: quick-connect terminals, dial stops, and transient protection module
- Easy-to-reach screw terminals, all on the face of the unit, clearly identified
- Modular assembly — timing head, coil assembly and switchblock are all individual modules, with switches field-replaceable
- File E15631, File LR29186



Design & Construction

There are three main components of Series 7000 Timing Relays:

Timing Head circulates air through a variable length to provide linearly adjustable timing. Patented design provides easy adjustment and long service life under severe operating conditions.

Precision-Wound Potted Coil

Total sealing without external leads eliminates moisture problems, gives maximum insulation value.

Snap-Action Switch Assembly — custom-designed over-center mechanism provides snap action. Standard switches are DPDT arrangement.

Each of these subassemblies forms self-contained modules assembled at the factory with the other two to afford a wide choice of operating types, coil voltages, and timing ranges.

The squared design with front terminals and rear mounting permits the grouping of Series 7000 units side-by-side in minimum panel space. Auxiliary switches may be added in the base of the unit, without affecting the overall width or depth.

Operation

Two basic operating types are available. "On-Delay" models provide a delay period on energization, at the end of which the switch transfers the load from one set of contacts to another. De-energizing the unit during the delay period immediately recycles the unit, readying it for another full delay period on re-energization.

In "Off-Delay" models the switch transfers the load immediately upon energization and the delay period does not begin until the unit is de-energized. At the end of the delay period the switch returns to its original position. Re-energizing the unit during the delay period immediately resets the timing, readying it for another full delay period on de-energization.

No power is required during the timing period, providing a true off delay.

In addition to these basic operating types, "Double-Head" models offer sequential delays on pull-in and drop-out in one unit. With the addition of auxiliary switches the basic models provide two-step timing.

Note: Seismic & radiation tested E7000 models are available. Consult factory for detailed information.

On-delay model 7012 (delay on pickup)

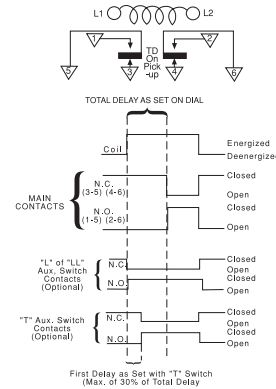

Applying voltage to the coil (L1-L2) for at least 50 msec starts a time delay lasting for the preset time. During this period the normally closed contacts (3-5 and 4-6) remain closed. At the end of the delay period the normally closed contacts break and the normally open contacts (1-5 and 2-6) make. The contacts remain in this transferred position until the coil is deenergized, at which time the switch returns to its original position.

De-energizing the coil, either during or after the delay period, will recycle the unit within 50 msec.

It will then provide a full delay period upon re-energization, regardless of how often the coil voltage is interrupted before the unit has been permitted to "time-out" to its full delay setting.

Off-delay model 7022 (delay on dropout)

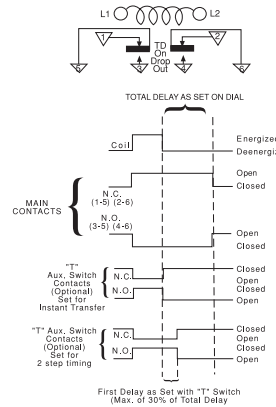

Applying voltage to the coil (for at least 50 msec) will transfer the switch, breaking the normally closed contacts (1-5 and 2-6), and making the normally open contacts (3-5 and 4-6). Contacts remain in this transferred position as long as the coil is energized. The time delay begins immediately upon de-energization. At the end of the delay period the switch returns to its normal position.

Re-energizing the coil during the delay period will immediately return the timing mechanism to a point where it will provide a full delay period upon subsequent de-energization. The switch remains in the transferred position.

Note: 7032 types and certain models with accessories are not agency approved.

Users should thoroughly review the technical data before selecting a product part number. It is recommended that users also seek out the pertinent approvals files of the agencies/laboratories and review them to ensure the product meets the requirements for a given application.

Consult factory for ordering information.

AGASTAT 7000 Series, Industrial Electropneumatic Timing Relay (Continued)

Auxiliary Switch Options

To increase the versatility of the basic timer models, auxiliary switches may be added to either on-delay or off-delay types. They switch additional circuits, provide two-step timing action, or furnish electrical interlock for sustained coil energization from a momentary impulse, depending on the type selected and its adjustment. They are installed at the factory. All auxiliary switches are SPDT with UL listings of 10A @ 125, 250, or 480 VAC. A maximum of one Code T or two Code L auxiliary switches may be added to each relay. The L or LL switch is available with on-delay relays only. The T switch is available with both the on-delay and off-delay relays.

Auxiliary Switch Options for On-Delay

Instant Transfer (Auxiliary Switch Code L, maximum of 2 per relay.)

1. Energizing coil begins time delay and transfers auxiliary switch.
2. Main switch transfers after total preset delay.
3. De-energizing coil resets both switches instantly.

Auxiliary switch is nonadjustable.

Two-Step Timing (Auxiliary Switch Code T, maximum of 1 per relay.)

1. Energizing coil begins time delay.
2. After first delay auxiliary switch transfers.
3. Main switch transfers after total preset delay.

4. De-energizing coil resets both switches instantly. First delay is independently adjustable, up to 30% of overall delay. (Recommended maximum 100 seconds.)

Auxiliary Switch Options for Off-Delay

In these models the same auxiliary switch provides either two-step timing or instant transfer action, depending on the adjustment of the actuator.

Two-Step Timing (Auxiliary Switch Code T, maximum of 1 per relay.)

1. Energizing coil transfers main and auxiliary switches instantly.
2. De-energizing coil begins time delay.
3. After first delay auxiliary switch transfers.

4. Main switch transfers after total preset delay. First delay is independently adjustable, up to 30% of overall delay. (Recommended maximum 100 seconds.)

Instant Transfer (Auxiliary Switch Code L, maximum of 1 per relay.)

1. Energizing coil transfers main and auxiliary switches instantly.
2. De-energizing coil resets auxiliary switch and begins time delay.
3. Main switch transfers after total preset delay.

Auxiliary switch is factory adjusted to give instant transfer operation. Two-step timing may be set at the factory to customer specification up to a 3:2 ratio.

On-delay, Off-delay Model 7032 (Double Head)

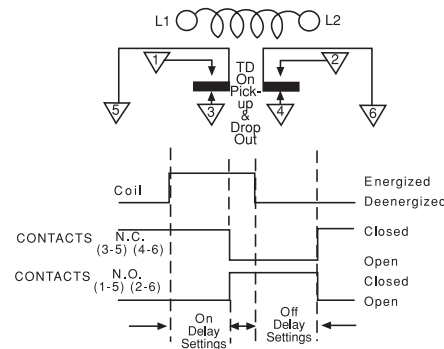

The Double Head model provides delayed switch transfer on energization of its coil, and delayed resetting upon coil de-energization. Each delay period is independently adjustable.

In new circuit designs or the improvement of existing controls now using two or more conventional timers, the Double Head unit offers distinct advantages.

Its compact design saves panel space, while the simplified wiring reduces costly interconnection.

On-delay Model 7014, Off-delay Model 7024

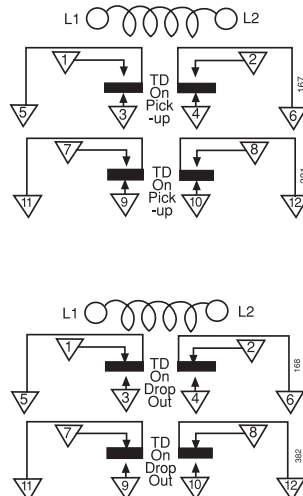
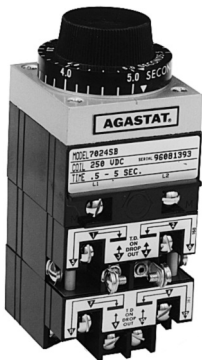

With the addition of an extra switch block at the bottom of the basic unit, this version of the Series 7000 offers four pole switch capacity with simultaneous timing or two-step timing. The two-step operation is achieved by factory adjustment to your specifications.

For two-step operation, a maximum timing ratio between upper and lower switches of 3:2 is recommended. Once adjusted at the factory, this ratio remains constant regardless of changes in dial settings. (Ex: If upper switch transfer is set on dial at 60 sec., minimum time on lower switch should be 40 sec.)

This Series 7000 unit offers many of the performance features found in basic models — voltage ranges, timing and switch capacities.

Four pole models add approximately 1-1/4" to the maximum height of the basic model, approximately 1/8" to the depth. They are designed for vertical operation only.

AGASTAT 7000 Series, Industrial Electropneumatic Timing Relay (Continued)

Surge/Transient Protection Option



Transient Suppressor
Option "V"

Product Facts

- Protect electronic control circuits from voltage transients generated by the timer coil
- Fast response to the rapidly rising back E.M.F.
- High performance clamping voltage characteristics
- UL recognized, (except varistor and coil together).
- Timer NOT polarity sensitive

The Surge/Transient Protection Option protects electronic control circuits from transients and surges which are generated when the timer coil is activated. The device is not polarity sensitive and permits the user to initiate, delay, sequence and program equipment actions over a wide range of applications under the most severe operating conditions. The varistor will not affect the operating characteristics of the 7000 Timer. The varistor has bilateral and symmetrical voltage and current characteristics.

Timing Specifications (All values shown are at nominal voltage and 25°C unless otherwise specified)

Operating Modes —

Model 7012/7014 — On-delay (delay on pick-up).
 Model 7022/7024 — Off-delay (delay on drop-out).
 Model 7032 — On-delay, off-delay (double head).

Timing Adjustment — Timing is set by simply turning the dial to the desired time value. In the zone of approximately 25° separating the high and low end of timing ranges A,D,E, and K, instantaneous operation (no time delay) will occur. All other ranges produce an infinite time delay when the dial is set in this zone.

Models 7014 and 7032 are available with letter dials only. The upper end of the time ranges in these models may be twice the values shown.

Linear Timing Ranges —

Code	Models 7012, 7022, 7024	Models 7014, 7032
A	.1 to 1 Sec.	.2 to 2 Sec.
B	.5 to 5 Sec.	.7 to 7 Sec.
C	1.5 to 15 Sec	2 to 20 Sec.
D	5 to 50 Sec.	10 to 100 Sec.
E	20 to 200 Sec.	30 to 300 Sec.
F	1 to 10 Min.	1.5 to 15 Min.
H	3 to 30 Min.	3 to 30 Min.
I	6 to 60 Min.	Not Avail.
J	3 to 120 Cyc.	Not Avail.
K	1 to 300 Sec.	Not Avail.

Repeat Accuracy —

For delays of 200 seconds or less:	7012*, 7022, 7024:	±5%
	7014*:	±10%
	7032:	±15%
For delays greater than 200 seconds:	7012*, 7022, 7014*, 7024:	±10%
	7032:	±15%

* The first time delay afforded by Model 7012 with H (3 to 30 min.) and I (6 to 60 min.) time ranges or Model 7014 with H time range will be approx. 15% longer than subsequent delays due to coil temperature rise.

Reset Time — 50 msec. (except model 7032)

Relay Release Time — 50 msec. for on-delay models (7012/7014)

Relay Operate Time — 50 msec. for off-delay models (7022/7024)

Operating Voltage Coil Data (for DPDT)

Coil Part #	Code Letter	Rated Voltage	Operating* Voltage Range @ 60Hz	Rated Voltage	Operating Voltage Range @ 50Hz	
7000	A	120	102-132	110	93.5-121	
	B	240	204-264	220	187-242	
	C	480	408-528			
	D	550	468-605			
	E	24	20.5-26.5			
AC	F			127	108-140	
	G			240	204-264	
	H	12	10.2-13.2			
	I	6	5.1-6.6			
	J	208	178-229			
	K		Dual Voltage Coil (Combines A&B)			
7010	L		Special AC Coils (L1, L2, etc.)			
	M	28	22.4-30.8			
	N	48	38.4-52.8			
	O	24	19.2-26.4			
	P	125	100-137.5			
	Q	12	9.6-13.2			
	R	60	48-66			
	DC	S	250	200-275		
		T	550	440-605		
		U	16	12.8-17.6		
		V	32	25.8-35.2		
W		96	76.8-105.6			
Y		6	4.8-6.6			
Z		220	176-242			
X		Special DC Coils (X1, X2, etc.)				

*Four pole Models: Operational voltage range 90% to 110% for AC units; 85% to 110% for DC units.

See next page for more coil data.

AGASTAT 7000 Series, Industrial Electropneumatic Timing Relay (Continued)

Timing Specifications (All values shown are at nominal voltage and 25°C unless otherwise specified)

Minimum operating voltages are based on vertically mounted 7012 units. 7012 horizontally mounted or 7022 vertically or horizontally mounted units will operate satisfactorily at minimum voltages approximately 5% lower than those listed.

AC units drop out at approximately 50% of rated voltage. DC units drop out at approximately 10% of rated voltage.

All units may be operated on intermittent duty cycles at voltages 10% above the listed maximums (intermittent duty - maximum 50% duty cycle and 30 minutes "on" time.)

Surge/Transient Protection Option Characteristics (DC Timers Only)

Coil Voltage Nominal (DC)	Max Excess Energy Capacity (Joule)	Max De-energization Transient Voltage
12 V	0.4 J	48 V
24 V	1.8 J	93 V
28 V	1.8 J	93 V
32 V	2.5 J	135 V
48 V	3.57 J	145 V
60 V	6 J	250 V
96 V	10 J	340 V
110 V	10 J	340 V
125 V	10 J	340 V
220 V	17 J	366 V
250 V	17 J	366 V

Surge Life —

Applied 100,000 times continuously with the interval of 10 seconds at room temperature. Below 68 VAC: 12A; Above 68 VAC: 35A

Temperature Range —

Operating — -22°F to +167°F (-30°C to + 75°C)

Storage — -40°F to +167°F (-40°C to +75°C)

Output/Life Contact Ratings — Contact Capacity in Amps (Resistive Load)

Contact Voltage	Min. 100,000 Operations	Min. 1,000,000 Operations
30 VDC	15.0	7.0
110 VDC	1.0	0.5
120 V 60Hz	20.0	15.0
240 V 60Hz	20.0	15.0
480 V 60Hz	12.0	10.0

10 Amps Resistive, 240 VAC

1/4 Horsepower, 120 VAC/240VAC (per pole)

15 Amps 30 VDC (per pole)

5 Amps, General Purpose, 600VAC (per pole)

Dielectric — Withstands 1500 volts RMS 60Hz between terminals and ground. 1,000 volts RMS 60 Hz between non-connected terminals. For dielectric specification on hermetically sealed models consult factory.

Insulation Resistance — 500 Megohms with 500VDC applied.

Temperature Range —

Operating — -20°F to +165°F (-29°C to 74°C)

Storage — -67°F to +165°F (-55°C to 74°C)

Temperature Variation — Using a fixed time delay which was set and measured when the ambient temperature was 77°F (25°C), the maximum observed shift in the average of three consecutive time delays was -20% at -20°F (-29°C) and +20% at 165°F (74°C).

Mounting/Terminals — Normal mounting of the basic unit is in a vertical position, from the back of the panel. **All units are tested for vertical operation.** Basic models (7012, 7022) may also be horizontally mounted, and will be adjusted accordingly **when Accessory Y1 is specified in your order.**

Standard screw terminals (8-32 truss head screws supplied) are located on the front of the unit, with permanent schematic markings. Barrier isolation is designed to accommodate spade or ring tongue terminals, with spacing to meet all industrial control specifications.

The basic Series 7000 may also be panel mounted with the addition of a panel mount kit, X option, that includes all necessary hardware and faceplate. This offers the convenience of "out-front" adjustment, with large dial skirt knob. The faceplate and knob blend with advanced equipment and console designs, while the body of the unit and its wiring are protected behind the panel.

Other mounting options include plug-in styles and special configurations to meet unusual installation requirements. Contact factory for details.

Power Consumption — Approximately 8 watts power at rated voltage .

Approximate Weights —

Models	7012, 7022	2 lbs. 4 ozs.
	7014, 7024	2 lbs. 10 ozs.
	7032	3 lbs. 5 ozs.

Weight may vary slightly with coil voltage.

AGASTAT 7000 Series, Industrial Electropneumatic Timing Relay (Continued)

Outline Dimensions (Dimensions in inches)

Models 7012, 7022

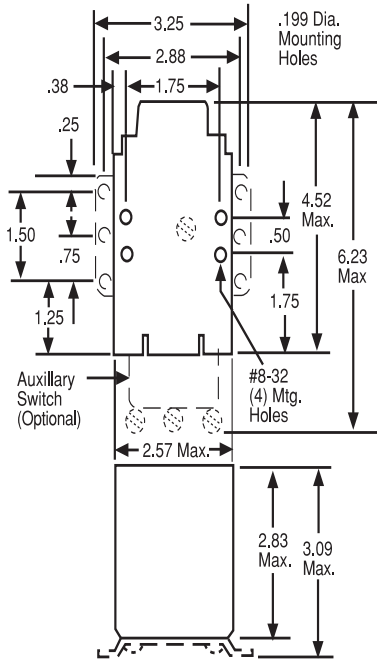

Models 7014, 7024

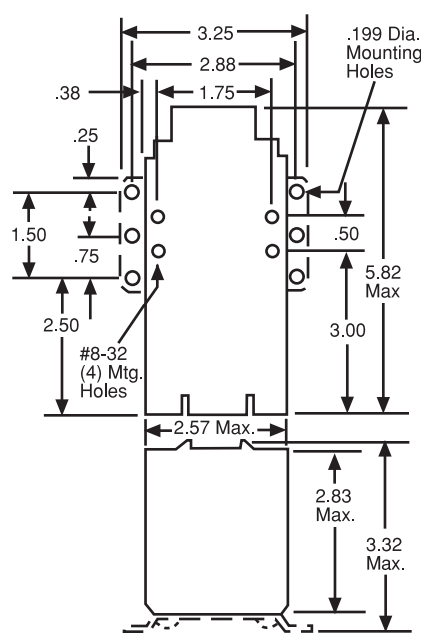

Model 7032

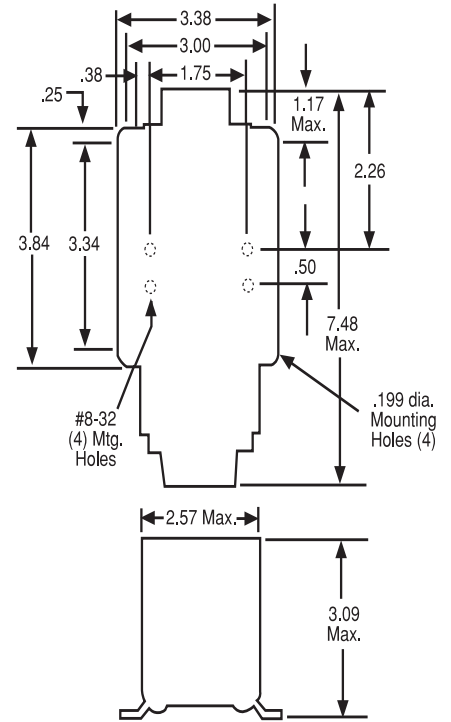

Panel Mount Option "X"

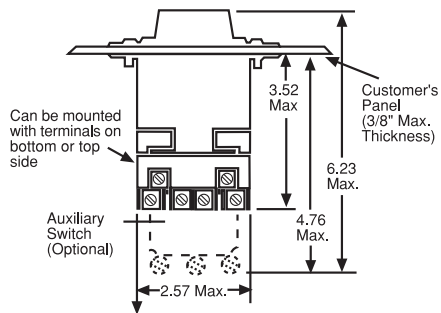

Surge/Transient Protection Option

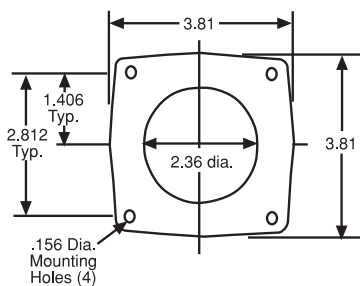
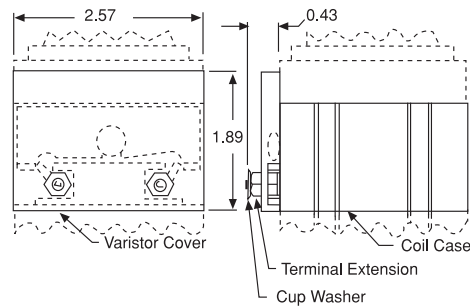

AGASTAT 7000 Series, Industrial Electropneumatic Timing Relay (Continued)

Ordering Information

Typical Part No. ▶	70	1	2	A	D	GZ		
<p>1. Basic Series: 70 = 7000 series electropneumatic timing relay</p>								
<p>2. Operation: 1 = On-delay 3 = On-delay, off-delay (double head) 2 = Off-delay</p>								
<p>3. Contact Arrangement: 2 = 2PDT (2 form C) **4 = 4PDT (4 form C)</p>								
<p>4. Coil Voltage:</p> <table border="0" style="width: 100%;"> <tr> <td style="width: 50%;"> <p>AC Coils</p> <p>A = 120VAC, 60 Hz.; 110VAC, 50Hz. B = 240VAC, 60 Hz.; 220VAC, 50Hz. C = 480VAC, 60 Hz. D = 550VAC, 60 Hz. E = 24VAC, 60 Hz. F = 127VAC, 50 Hz. G = 240VAC, 50Hz. H = 12VAC, 60 Hz. K = Dual voltage (combines A & B) L = Special AC coils (L1, L2, etc.)</p> </td> <td style="width: 50%;"> <p>DC Coils</p> <p>M = 28VDC N = 48VDC O = 24VDC P = 125VDC Q = 12VDC R = 60VDC S = 250VDC T = 550VDC U = 16VDC V = 32VDC W = 96VDC Y = 6VDC Z = 220VDC X = Special DC coils (X1, X2, etc.)</p> </td> </tr> </table>							<p>AC Coils</p> <p>A = 120VAC, 60 Hz.; 110VAC, 50Hz. B = 240VAC, 60 Hz.; 220VAC, 50Hz. C = 480VAC, 60 Hz. D = 550VAC, 60 Hz. E = 24VAC, 60 Hz. F = 127VAC, 50 Hz. G = 240VAC, 50Hz. H = 12VAC, 60 Hz. K = Dual voltage (combines A & B) L = Special AC coils (L1, L2, etc.)</p>	<p>DC Coils</p> <p>M = 28VDC N = 48VDC O = 24VDC P = 125VDC Q = 12VDC R = 60VDC S = 250VDC T = 550VDC U = 16VDC V = 32VDC W = 96VDC Y = 6VDC Z = 220VDC X = Special DC coils (X1, X2, etc.)</p>
<p>AC Coils</p> <p>A = 120VAC, 60 Hz.; 110VAC, 50Hz. B = 240VAC, 60 Hz.; 220VAC, 50Hz. C = 480VAC, 60 Hz. D = 550VAC, 60 Hz. E = 24VAC, 60 Hz. F = 127VAC, 50 Hz. G = 240VAC, 50Hz. H = 12VAC, 60 Hz. K = Dual voltage (combines A & B) L = Special AC coils (L1, L2, etc.)</p>	<p>DC Coils</p> <p>M = 28VDC N = 48VDC O = 24VDC P = 125VDC Q = 12VDC R = 60VDC S = 250VDC T = 550VDC U = 16VDC V = 32VDC W = 96VDC Y = 6VDC Z = 220VDC X = Special DC coils (X1, X2, etc.)</p>							
<p>5. Timing Range:</p> <table border="0" style="width: 100%;"> <tr> <td style="width: 50%;"> <p>Models 7012, 7022 & 7024</p> <p>A = .1 to 1 sec. B = .5 to 5 sec. C = 1.5 to 15 sec. D = 5 to 50 sec. E = 20 to 200 sec. F = 1 to 10 min. H = 3 to 30 min. I = 6 to 60 min. J = 3 to 120 cyc. K = 1 to 300 sec.</p> </td> <td style="width: 50%;"> <p>†Models 7014 & 7032</p> <p>For model 7032 specify separate time range code for each head. Example: AB. Any two ranges may be selected.</p> <p>A = .2 to 2 sec. B = .7 to 7 sec. C = 2 to 20 sec. D = 10 to 100 sec. E = 30 to 300 sec. F = 1.5 to 15 min. H = 3 to 30 min.</p> </td> </tr> </table>							<p>Models 7012, 7022 & 7024</p> <p>A = .1 to 1 sec. B = .5 to 5 sec. C = 1.5 to 15 sec. D = 5 to 50 sec. E = 20 to 200 sec. F = 1 to 10 min. H = 3 to 30 min. I = 6 to 60 min. J = 3 to 120 cyc. K = 1 to 300 sec.</p>	<p>†Models 7014 & 7032</p> <p>For model 7032 specify separate time range code for each head. Example: AB. Any two ranges may be selected.</p> <p>A = .2 to 2 sec. B = .7 to 7 sec. C = 2 to 20 sec. D = 10 to 100 sec. E = 30 to 300 sec. F = 1.5 to 15 min. H = 3 to 30 min.</p>
<p>Models 7012, 7022 & 7024</p> <p>A = .1 to 1 sec. B = .5 to 5 sec. C = 1.5 to 15 sec. D = 5 to 50 sec. E = 20 to 200 sec. F = 1 to 10 min. H = 3 to 30 min. I = 6 to 60 min. J = 3 to 120 cyc. K = 1 to 300 sec.</p>	<p>†Models 7014 & 7032</p> <p>For model 7032 specify separate time range code for each head. Example: AB. Any two ranges may be selected.</p> <p>A = .2 to 2 sec. B = .7 to 7 sec. C = 2 to 20 sec. D = 10 to 100 sec. E = 30 to 300 sec. F = 1.5 to 15 min. H = 3 to 30 min.</p>							
<p>6. Options:</p> <table border="0" style="width: 100%;"> <tr> <td style="width: 50%;"> <p>A1 = Single quick-connect terminals (note 4). A2 = Double quick-connect terminals (note 4). B = Plug-in connectors (note 4). GZ = Enclosure with bottom knockouts (note 1). H2 = Hermetically sealed enclosure, 8 pin solder (notes 1 & 4). H3 = Hermetically sealed enclosure, 8 pin octal (notes 1 & 4). H4 = Hermetically sealed enclosure, 8 screw terminal block (notes 1 & 4). *H6 = Hermetically sealed enclosure, 11 pin solder (notes 1 & 4). *H7 = Hermetically sealed enclosure, 11 pin octal (notes 1 & 4). *H8 = Hermetically sealed enclosure, 11 screw terminal block (notes 1 & 4). I1 = Tamper-proof Cap, opaque black (Cannot be combined with Option X).</p> </td> <td style="width: 50%;"> <p>I2 = Tamper-proof Cap, transparent (Cannot be combined with Option X). L = Auxiliary Switch, instant transfer. 7012 only (notes 2 & 6). LL = Two Aux. Switches, instant transfer. On Model 7014 Factory Installed Only. (notes 2 & 6) M = Dust-tight Gasketing (notes 4 & 5). P = Octal Plug Adapter. Can be combined only with options I1,I2, M, S, X, or Y1. (note 4). S = Dial Stops. T = Auxiliary Switch, two-step timing (notes 2 & 6). V = Transient/Surge Protection (for DC coil voltage only). X = Panelmount includes hardware and adjustment for horizontal operation (note 4) Y1 = Horizontal testing, for horizontal operation without panel mounting (note 4). Y2 = Horizontal testing, with Compensating Spring for vertical operation (note 4).</p> </td> </tr> </table>							<p>A1 = Single quick-connect terminals (note 4). A2 = Double quick-connect terminals (note 4). B = Plug-in connectors (note 4). GZ = Enclosure with bottom knockouts (note 1). H2 = Hermetically sealed enclosure, 8 pin solder (notes 1 & 4). H3 = Hermetically sealed enclosure, 8 pin octal (notes 1 & 4). H4 = Hermetically sealed enclosure, 8 screw terminal block (notes 1 & 4). *H6 = Hermetically sealed enclosure, 11 pin solder (notes 1 & 4). *H7 = Hermetically sealed enclosure, 11 pin octal (notes 1 & 4). *H8 = Hermetically sealed enclosure, 11 screw terminal block (notes 1 & 4). I1 = Tamper-proof Cap, opaque black (Cannot be combined with Option X).</p>	<p>I2 = Tamper-proof Cap, transparent (Cannot be combined with Option X). L = Auxiliary Switch, instant transfer. 7012 only (notes 2 & 6). LL = Two Aux. Switches, instant transfer. On Model 7014 Factory Installed Only. (notes 2 & 6) M = Dust-tight Gasketing (notes 4 & 5). P = Octal Plug Adapter. Can be combined only with options I1,I2, M, S, X, or Y1. (note 4). S = Dial Stops. T = Auxiliary Switch, two-step timing (notes 2 & 6). V = Transient/Surge Protection (for DC coil voltage only). X = Panelmount includes hardware and adjustment for horizontal operation (note 4) Y1 = Horizontal testing, for horizontal operation without panel mounting (note 4). Y2 = Horizontal testing, with Compensating Spring for vertical operation (note 4).</p>
<p>A1 = Single quick-connect terminals (note 4). A2 = Double quick-connect terminals (note 4). B = Plug-in connectors (note 4). GZ = Enclosure with bottom knockouts (note 1). H2 = Hermetically sealed enclosure, 8 pin solder (notes 1 & 4). H3 = Hermetically sealed enclosure, 8 pin octal (notes 1 & 4). H4 = Hermetically sealed enclosure, 8 screw terminal block (notes 1 & 4). *H6 = Hermetically sealed enclosure, 11 pin solder (notes 1 & 4). *H7 = Hermetically sealed enclosure, 11 pin octal (notes 1 & 4). *H8 = Hermetically sealed enclosure, 11 screw terminal block (notes 1 & 4). I1 = Tamper-proof Cap, opaque black (Cannot be combined with Option X).</p>	<p>I2 = Tamper-proof Cap, transparent (Cannot be combined with Option X). L = Auxiliary Switch, instant transfer. 7012 only (notes 2 & 6). LL = Two Aux. Switches, instant transfer. On Model 7014 Factory Installed Only. (notes 2 & 6) M = Dust-tight Gasketing (notes 4 & 5). P = Octal Plug Adapter. Can be combined only with options I1,I2, M, S, X, or Y1. (note 4). S = Dial Stops. T = Auxiliary Switch, two-step timing (notes 2 & 6). V = Transient/Surge Protection (for DC coil voltage only). X = Panelmount includes hardware and adjustment for horizontal operation (note 4) Y1 = Horizontal testing, for horizontal operation without panel mounting (note 4). Y2 = Horizontal testing, with Compensating Spring for vertical operation (note 4).</p>							

Notes:

1. Cannot be combined with B, P or X Options
 2. Cannot be combined with B, P or Y2 Options
 3. Cannot be combined with GZ, H, I1, I2, K, W or Y1 Options
 4. Not Avail. on 4-Pole Models
 5. Not Available with L, T or LL options.
 6. Not Available on hermetically sealed units.
- * Sized to accommodate one L or T Auxiliary Switch
** Not available on 7032 model.
† Available with letter graduated dials only. Upper end of time range may be twice the value shown
†† 120 cycles = 2 sec.

Our authorized distributors are more likely to maintain the following items in stock for immediate delivery.

7012AA	7012AE	7012ACL	7012PB	7012PJ	7022AA	7022AE	7022AJ	7022PA
7012AB	7012AF	7012BC	7012PC	7012PK	7022AB	7022AF	7022AKT	7022PB
7012AC	7012AH	7012NC	7012PD	7012PKX	7022AC	7022AH	7022BC	7022PC
7012AD	7012AK	7012PA	7012PF	7012PJX	7022AD	7022AI	7022BK	7022PK

AGASTAT 7000 Series, Industrial Electropneumatic Timing Relay (Continued)

Ordering Options — Can only be ordered as factory installed options (Dimensions, where shown, are in inches)

A1 – Single Quick-Connect Terminals

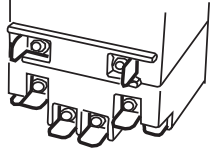

A2 – Double Quick-Connect Terminals

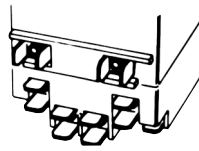

B – Plug-In Connectors
Use with Accessory "C" or "D" below.

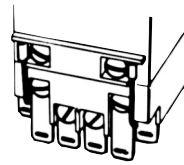

GZ – Metal Enclosure
With knockouts for bottom connection.
3.16" W x 3.84" D x 7.63"H

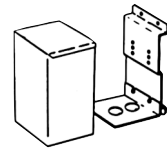

H – Hermetically Sealed Enclosure



I – Tamper-Proof Cover

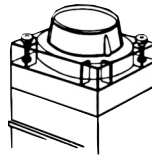

L – Auxiliary Switch

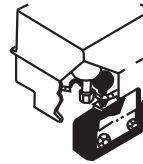

LL – Auxiliary Switch

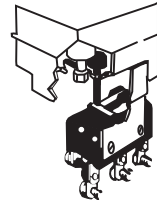

M – Dust tight

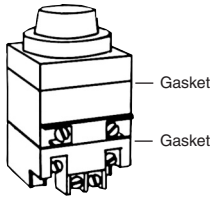

P – Octal Plug Adapter

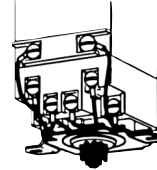

S – Dial Stops

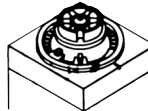

T – Auxiliary Switch

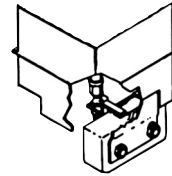

V – Transient/Surge Protection

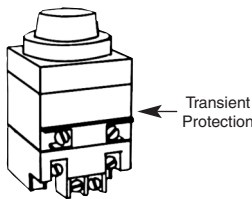

X – Panelmount Kit
Mounting hardware included.

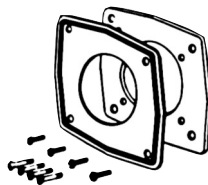

Accessories (Not available for 7032 models)

Plug-In Receptacle (Accessory C)

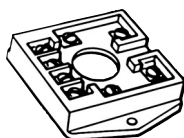

Screw Terminals
Catalog No. 700137.
For use with "B" Option.

Plug-In Receptacle (Accessory D)

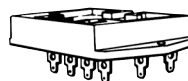

Quick Connect Terminals
Catalog No. 700141.
For use with "B" Option.

Ordering options can only be ordered as factory installed options.



Стандарт Электрон Связь

Мы молодая и активно развивающаяся компания в области поставок электронных компонентов. Мы поставляем электронные компоненты отечественного и импортного производства напрямую от производителей и с крупнейших складов мира.

Благодаря сотрудничеству с мировыми поставщиками мы осуществляем комплексные и плановые поставки широчайшего спектра электронных компонентов.

Собственная эффективная логистика и склад в обеспечивает надежную поставку продукции в точно указанные сроки по всей России.

Мы осуществляем техническую поддержку нашим клиентам и предпродажную проверку качества продукции. На все поставляемые продукты мы предоставляем гарантию .

Осуществляем поставки продукции под контролем ВП МО РФ на предприятия военно-промышленного комплекса России , а также работаем в рамках 275 ФЗ с открытием отдельных счетов в уполномоченном банке. Система менеджмента качества компании соответствует требованиям ГОСТ ISO 9001.

Минимальные сроки поставки, гибкие цены, неограниченный ассортимент и индивидуальный подход к клиентам являются основой для выстраивания долгосрочного и эффективного сотрудничества с предприятиями радиоэлектронной промышленности, предприятиями ВПК и научно-исследовательскими институтами России.

С нами вы становитесь еще успешнее!

Наши контакты:

Телефон: +7 812 627 14 35

Электронная почта: sales@st-electron.ru

Адрес: 198099, Санкт-Петербург,
Промышленная ул, дом № 19, литера Н,
помещение 100-Н Офис 331