

# NHPV08S600G, NHPJ08S600G

## Switch Mode Power Rectifiers

### Features

- Ultrafast 30 Nanosecond Recovery Time
- 150°C Operating Junction Temperature
- High Voltage Capability of 600 V
- Low Forward Drop
- Low Leakage Specified @ 125°C Case Temperature
- These Devices are Pb-Free and RoHS Compliant
- NHPJ08S600G is a Halogen Free/BFR Free Device

### Mechanical Characteristics:

- Case: Epoxy, Molded
- Weight: 1.9 Grams (Approximately)
- Finish: All External Surfaces Corrosion Resistant and Terminal Leads are Readily Solderable
- Lead Temperature for Soldering Purposes: 260°C Max. for 10 Seconds



ON Semiconductor®

<http://onsemi.com>

### PLANAR ULTRAFAST RECTIFIERS 8 A, 600 V

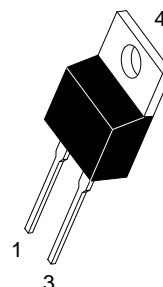
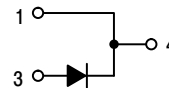

TO-220AC  
CASE 221B

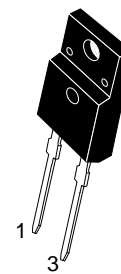

TO-220 FULLPAK  
CASE 221AG

### MARKING DIAGRAMS

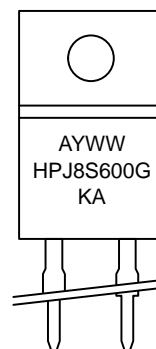

- A = Assembly Location
- Y = Year
- WW = Work Week
- G = Pb-Free Package
- KA = Diode Polarity

\*For additional information on our Pb-Free strategy and soldering details, please download the ON Semiconductor Soldering and Mounting Techniques Reference Manual, SOLDERRM/D.

### ORDERING INFORMATION

See detailed ordering and shipping information in the package dimensions section on page 2 of this data sheet.

# NHPV08S600G, NHPJ08S600G

## MAXIMUM RATINGS

Rating	Symbol	Value	Unit
Peak Repetitive Reverse Voltage Working Peak Reverse Voltage DC Blocking Voltage	$V_{RRM}$ $V_{RWM}$ $V_R$	600	V
Average Rectified Forward Current (Rated $V_R$ )	TO-220AC TO-220FP $I_{F(AV)}$	8 A @ $T_C = 130^\circ\text{C}$ 8 A @ $T_C = 95^\circ\text{C}$	A
Peak Rectified Forward Current (Rated $V_R$ , Square Wave, 20 kHz)	TO-220AC TO-220FP $I_{FRM}$	8 A @ $T_C = 125^\circ\text{C}$ 8 A @ $T_C = 85^\circ\text{C}$	A
Nonrepetitive Peak Surge Current (Surge applied at rated load conditions halfwave, single phase, 60 Hz)	$I_{FSM}$	80	A
Operating Junction Temperature and Storage Temperature Range	$T_J, T_{stg}$	-55 to +150	$^\circ\text{C}$

Stresses exceeding Maximum Ratings may damage the device. Maximum Ratings are stress ratings only. Functional operation above the Recommended Operating Conditions is not implied. Extended exposure to stresses above the Recommended Operating Conditions may affect device reliability.

## THERMAL CHARACTERISTICS

Characteristic	Symbol	Value	Unit
NHPV08S600G: Thermal Resistance Junction-to-Case (Note 1)	$R_{\theta JC}$	1.5	$^\circ\text{C}/\text{W}$
NHPJ08S600G: Thermal Resistance Junction-to-Case (Note 1)	$R_{\theta JC}$	4.25	$^\circ\text{C}/\text{W}$

1. Junction-to-Case shown as a typical value using a fixed  $25^\circ\text{C}$  cold plate boundary.

## ELECTRICAL CHARACTERISTICS

Characteristic	Test Conditions	Symbol	Typ	Max	Unit
Instantaneous Forward Voltage (Note 2)	( $I_F = 8\text{ A}, T_C = 125^\circ\text{C}$ ) ( $I_F = 8\text{ A}, T_C = 25^\circ\text{C}$ )	$v_F$	1.5 2.7	1.8 3.2	V
Instantaneous Reverse Current (Note 2)	(Rated DC Voltage, $T_C = 125^\circ\text{C}$ ) (Rated DC Voltage, $T_C = 25^\circ\text{C}$ )	$i_R$	46 0.1	400 30	$\mu\text{A}$
Reverse Recovery Time	( $I_F = 0.5\text{ A}, I_{rr} = 0.25\text{ A}, I_R = 1\text{ A}$ ) ( $I_F = 1\text{ A}, di_F/dt = -50\text{ A}/\mu\text{s}, V_R = 30\text{ V}$ )	$t_{rr}$	- -	30 50	ns
Reverse Recovery Time Peak Reverse Recovery Current Total Reverse Recovery Charge Softness Factor	( $I_F = 8\text{ A}, di_F/dt = -200\text{ A}/\mu\text{s}, T_C = 25^\circ\text{C}$ )	$t_{rr}$ $I_{RM}$ $Q_{rr}$ S	30 2.3 37 2	50 3 50 -	ns A nC -
Reverse Recovery Time Peak Reverse Recovery Current Total Reverse Recovery Charge Softness Factor	( $I_F = 8\text{ A}, di_F/dt = -200\text{ A}/\mu\text{s}, T_C = 125^\circ\text{C}$ )	$t_{rr}$ $I_{RM}$ $Q_{rr}$ S	45 5.5 150 0.35	- - - -	ns A nC -
Forward Recovery Time Peak Forward Recovery Voltage	( $I_F = 8\text{ A}, di_F/dt = 120\text{ A}/\mu\text{s}, T_C = 25^\circ\text{C}$ )	$t_{fr}$ $V_{FP}$	- -	200 6	ns V

2. Pulse Test: Pulse Width = 300  $\mu\text{s}$ , Duty Cycle  $\leq 2.0\%$ .

## ORDERING INFORMATION

Device	Package	Shipping†
NHPV08S600G	TO-220AC (Pb-Free)	50 Units / Rail
NHPJ08S600G	TO-220FP (Pb-Free / Halide-Free)	50 Units / Rail

†For information on tape and reel specifications, including part orientation and tape sizes, please refer to our Tape and Reel Packaging Specifications Brochure, BRD8011/D.

TYPICAL CHARACTERISTICS

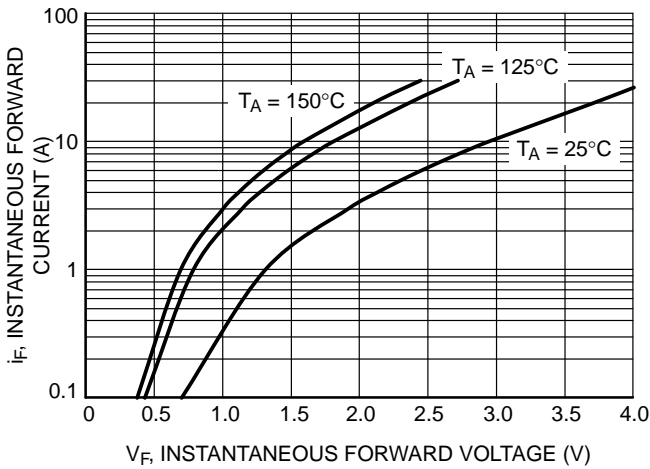

Figure 1. Typical Instantaneous Forward Characteristics

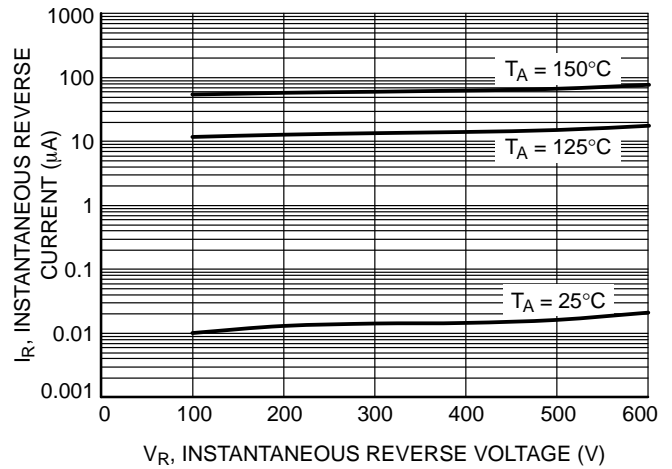

Figure 2. Typical Reverse Characteristics

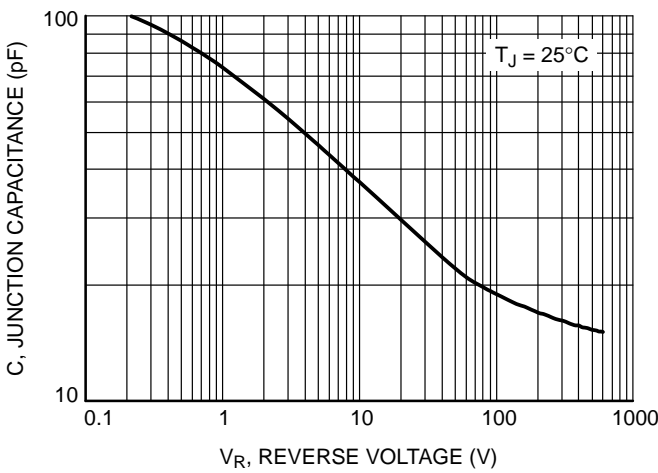

Figure 3. Typical Junction Capacitance

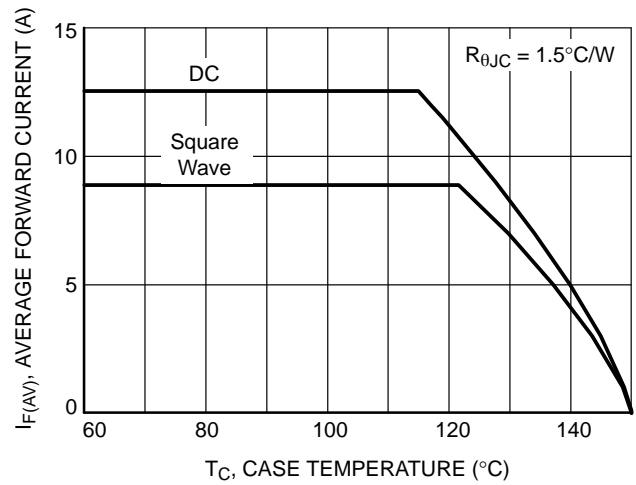

Figure 4. Current Derating TO-220AC

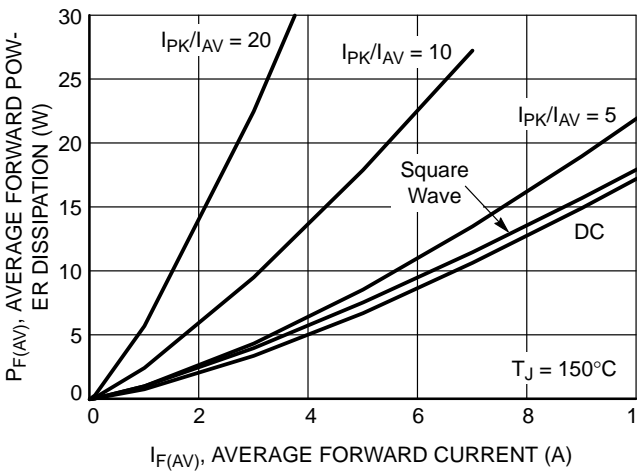

Figure 5. Forward Power Dissipation

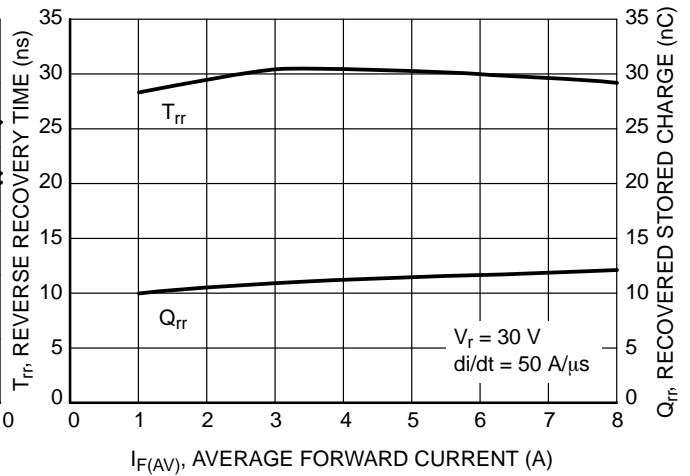
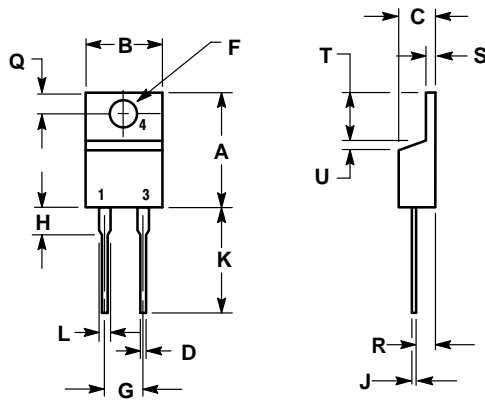

Figure 6. Typical Recovery Characteristics

# NHPV08S600G, NHPJ08S600G

## PACKAGE DIMENSIONS

### TO-220 TWO-LEAD CASE 221B-04 ISSUE E



- NOTES:  
1. DIMENSIONING AND TOLERANCING PER ANSI Y14.5M, 1982.  
2. CONTROLLING DIMENSION: INCH.

DIM	INCHES		MILLIMETERS	
	MIN	MAX	MIN	MAX
A	0.595	0.620	15.11	15.75
B	0.380	0.405	9.65	10.29
C	0.160	0.190	4.06	4.82
D	0.025	0.035	0.64	0.89
F	0.142	0.161	3.61	4.09
G	0.190	0.210	4.83	5.33
H	0.110	0.130	2.79	3.30
J	0.014	0.025	0.36	0.64
K	0.500	0.562	12.70	14.27
L	0.045	0.060	1.14	1.52
Q	0.100	0.120	2.54	3.04
R	0.080	0.110	2.04	2.79
S	0.045	0.055	1.14	1.39
T	0.235	0.255	5.97	6.48
U	0.000	0.050	0.000	1.27

### TO-220 FULLPAK, 2-LEAD CASE 221AG ISSUE O

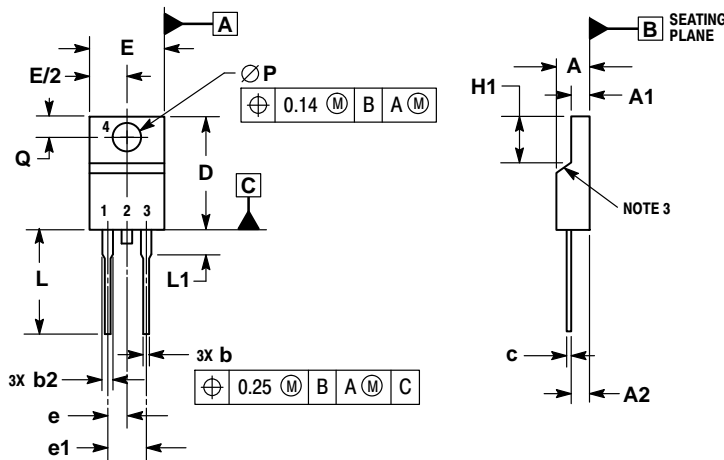

- NOTES:  
1. DIMENSIONING AND TOLERANCING PER ASME Y14.5M, 1994.  
2. CONTROLLING DIMENSION: MILLIMETERS.  
3. CONTOUR UNCONTROLLED IN THIS AREA.  
4. DIMENSIONS D AND E DO NOT INCLUDE MOLD FLASH AND GATE PROTRUSIONS. MOLD FLASH AND GATE PROTRUSIONS NOT TO EXCEED 0.13 PER SIDE. THESE DIMENSIONS ARE TO BE MEASURED AT OUTERMOST EXTREME OF THE PLASTIC BODY.  
5. DIMENSION b2 DOES NOT INCLUDE DAMBAR PROTRUSION. LEAD WIDTH INCLUDING PROTRUSION SHALL NOT EXCEED 2.00.

DIM	MILLIMETERS	
	MIN	MAX
A	4.30	4.70
A1	2.50	2.90
A2	2.50	2.70
b	0.54	0.84
b2	1.10	1.40
c	0.49	0.79
D	14.22	15.88
E	9.65	10.67
e	2.54 BSC	
e1	5.08 BSC	
H1	5.97	6.48
L	12.70	14.73
L1	---	2.80
P	3.00	3.40
Q	2.80	3.20

ON Semiconductor and are registered trademarks of Semiconductor Components Industries, LLC (SCILLC). SCILLC owns the rights to a number of patents, trademarks, copyrights, trade secrets, and other intellectual property. A listing of SCILLC's product/patent coverage may be accessed at [www.onsemi.com/site/pdf/Patent-Marking.pdf](http://www.onsemi.com/site/pdf/Patent-Marking.pdf). SCILLC reserves the right to make changes without further notice to any products herein. SCILLC makes no warranty, representation or guarantee regarding the suitability of its products for any particular purpose, nor does SCILLC assume any liability arising out of the application or use of any product or circuit, and specifically disclaims any and all liability, including without limitation special, consequential or incidental damages. "Typical" parameters which may be provided in SCILLC data sheets and/or specifications can and do vary in different applications and actual performance may vary over time. All operating parameters, including "Typicals" must be validated for each customer application by customer's technical experts. SCILLC does not convey any license under its patent rights nor the rights of others. SCILLC products are not designed, intended, or authorized for use as components in systems intended for surgical implant into the body, or other applications intended to support or sustain life, or for any other application in which the failure of the SCILLC product could create a situation where personal injury or death may occur. Should Buyer purchase or use SCILLC products for any such unintended or unauthorized application, Buyer shall indemnify and hold SCILLC and its officers, employees, subsidiaries, affiliates, and distributors harmless against all claims, costs, damages, and expenses, and reasonable attorney fees arising out of, directly or indirectly, any claim of personal injury or death associated with such unintended or unauthorized use, even if such claim alleges that SCILLC was negligent regarding the design or manufacture of the part. SCILLC is an Equal Opportunity/Affirmative Action Employer. This literature is subject to all applicable copyright laws and is not for resale in any manner.

## PUBLICATION ORDERING INFORMATION

**LITERATURE FULFILLMENT:**  
Literature Distribution Center for ON Semiconductor  
P.O. Box 5163, Denver, Colorado 80217 USA  
**Phone:** 303-675-2175 or 800-344-3860 Toll Free USA/Canada  
**Fax:** 303-675-2176 or 800-344-3867 Toll Free USA/Canada  
**Email:** [orderlit@onsemi.com](mailto:orderlit@onsemi.com)

**N. American Technical Support:** 800-282-9855 Toll Free  
USA/Canada  
**Europe, Middle East and Africa Technical Support:**  
Phone: 421 33 790 2910  
**Japan Customer Focus Center**  
Phone: 81-3-5817-1050

**ON Semiconductor Website:** [www.onsemi.com](http://www.onsemi.com)  
**Order Literature:** <http://www.onsemi.com/orderlit>  
For additional information, please contact your local Sales Representative



## Стандарт Электрон Связь

Мы молодая и активно развивающаяся компания в области поставок электронных компонентов. Мы поставляем электронные компоненты отечественного и импортного производства напрямую от производителей и с крупнейших складов мира.

Благодаря сотрудничеству с мировыми поставщиками мы осуществляем комплексные и плановые поставки широчайшего спектра электронных компонентов.

Собственная эффективная логистика и склад в обеспечивает надежную поставку продукции в точно указанные сроки по всей России.

Мы осуществляем техническую поддержку нашим клиентам и предпродажную проверку качества продукции. На все поставляемые продукты мы предоставляем гарантию .

Осуществляем поставки продукции под контролем ВП МО РФ на предприятия военно-промышленного комплекса России , а также работаем в рамках 275 ФЗ с открытием отдельных счетов в уполномоченном банке. Система менеджмента качества компании соответствует требованиям ГОСТ ISO 9001.

Минимальные сроки поставки, гибкие цены, неограниченный ассортимент и индивидуальный подход к клиентам являются основой для выстраивания долгосрочного и эффективного сотрудничества с предприятиями радиоэлектронной промышленности, предприятиями ВПК и научно-исследовательскими институтами России.

С нами вы становитесь еще успешнее!

### Наши контакты:

**Телефон:** +7 812 627 14 35

**Электронная почта:** [sales@st-electron.ru](mailto:sales@st-electron.ru)

**Адрес:** 198099, Санкт-Петербург,  
Промышленная ул, дом № 19, литера Н,  
помещение 100-Н Офис 331