

GAAS MMIC VOLTAGE VARIABLE ATTENUATOR, 0.5 - 5.0 GHz

Typical Applications

The HMC973ALP3E is ideal for:

- Point-to-Point Radio
- Cellular/3G & WiMAX/4G Infrastructure
- Test Instrumentation
- Microwave Sensors
- Military, ECM & Radar

Features

- Wide Attenuation Range: 26 dB
- Single Positive Voltage Control: 0 to +5V
- Absorptive Topology
- 16 Lead 3x3mm SMT Package: 9 mm²

Functional Diagram

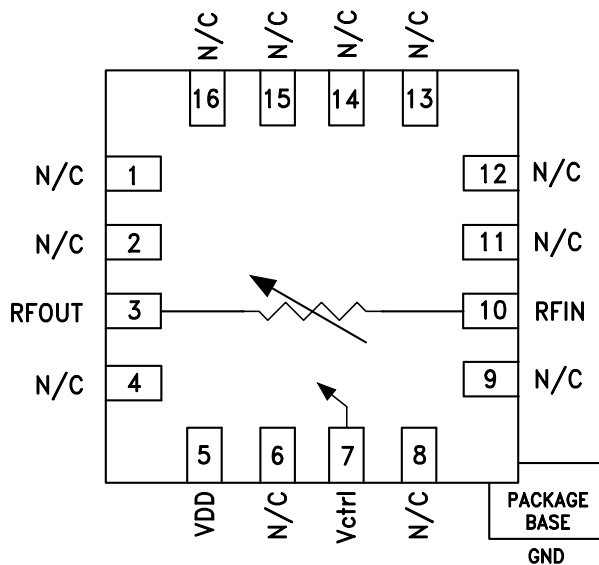

General Description

The HMC973ALP3E is an absorptive Voltage Variable Attenuator (VVA) which operates from 0.5 to 5 GHz and is ideal in designs where an analog DC control signal must be used to control RF signal levels over a 26 dB amplitude range. It features a shunt-type attenuator controlled by an analog voltage, V_{ctrl} . The HMC973ALP3E is an unidirectional device with optimum linearity performance achieved when the RF input signal is applied to the RFIN package lead. The HMC973ALP3E is housed in a RoHS compliant 3x3 mm QFN leadless package.

Electrical Specifications, $T_A = +25^\circ\text{C}$, 50 Ohm system, $V_{dd} = +5V$

Parameter	Frequency	Min.	Typ.	Max.	Units
Insertion Loss	0.5 - 2.0 GHz		3.3		dB
	2.0 - 4.0 GHz		4.2		dB
	4.0 - 5.0 GHz		5.6		dB
Attenuation Range	0.5 - 2.0 GHz		26		dB
	2.0 - 4.0 GHz		28		dB
	4.0 - 5.0 GHz		31		dB
Input Return Loss	0.5 - 2.0 GHz		10		dB
	2.0 - 5.0 GHz		13		dB
Output Return Loss	0.5 - 2.0 GHz		8		dB
	2.0 - 5.0 GHz		9		dB
Input Power for 1 dB Compression	0.5 - 5.0 GHz		25		dBm
Input Third Order Intercept (All Control Voltages) (Two-tone Input Power = +5 dBm Each Tone)	0.5 - 5.0 GHz		30		dBm
Supply Current (I_{dd})	0.5 - 5.0 GHz		600		μA

GAAS MMIC VOLTAGE VARIABLE ATTENUATOR, 0.5 - 5.0 GHz

Insertion Loss vs. Frequency Over Temperature @ VDD=5 V

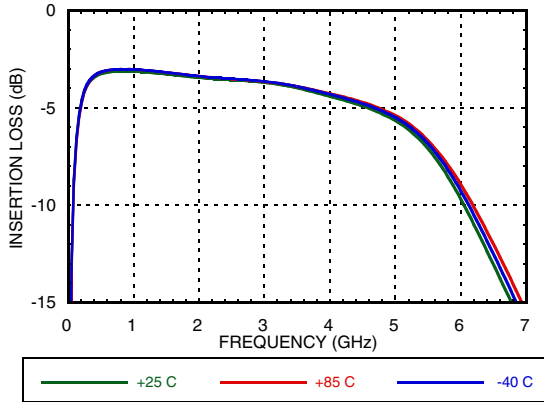

Attenuation vs. Frequency Over Vctrl @ VDD=5 V

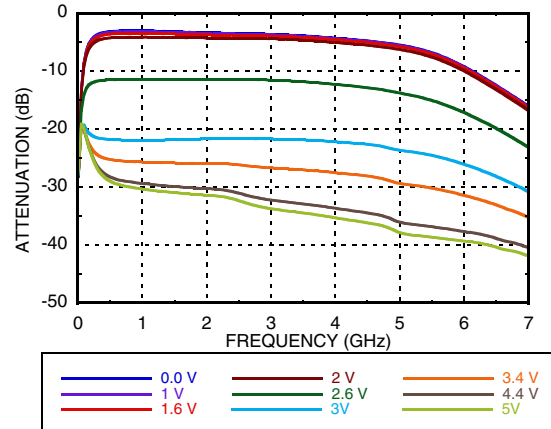

Attenuation vs. Vctrl Over Temperature @ 0.5 GHz and VDD=5 V

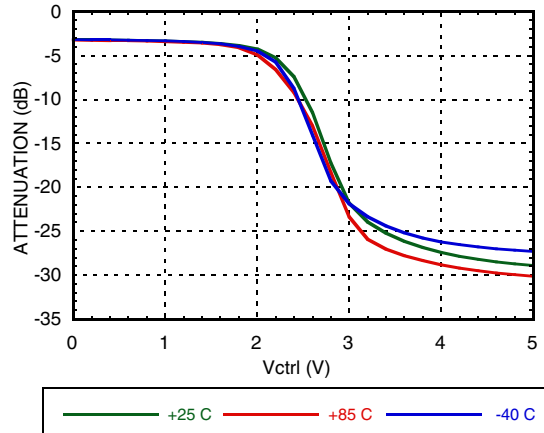

Attenuation vs. Vctrl Over Temperature @ 2 GHz and VDD=5 V

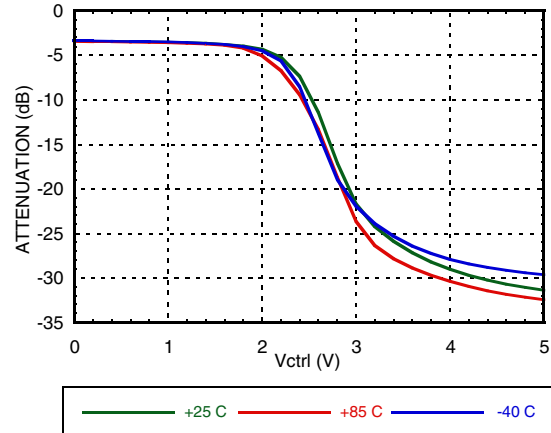

Attenuation vs. Vctrl Over Temperature @ 4 GHz and VDD=5 V

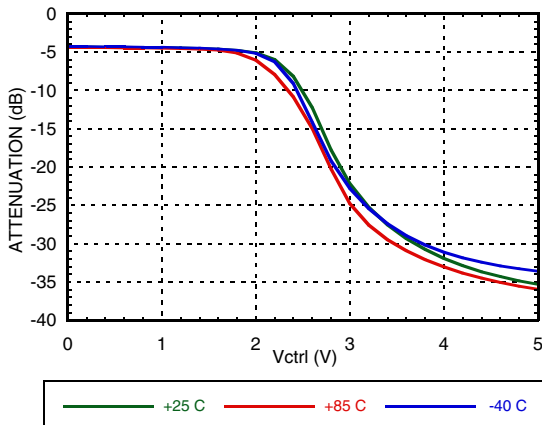

Attenuation vs. Vctrl Over Temperature @ 5 GHz and VDD=5 V

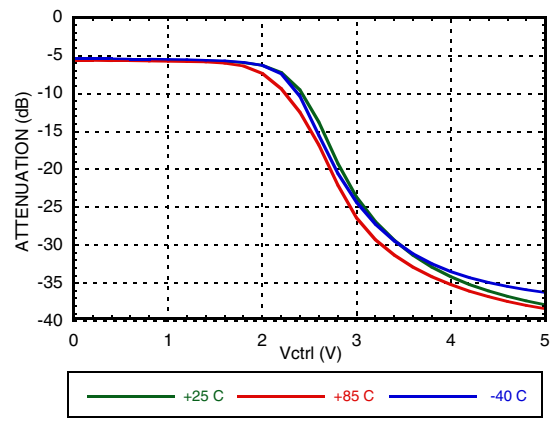

GAAS MMIC VOLTAGE VARIABLE ATTENUATOR, 0.5 - 5.0 GHz

Input Return Loss Over Temperature (Vctrl = 0) @ VDD=5 V

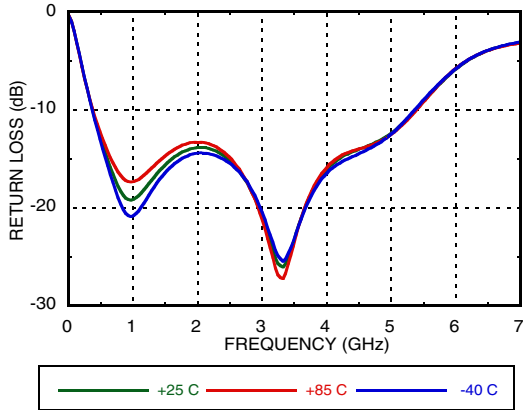

Input Return Loss Over Vctrl @ VDD=5 V

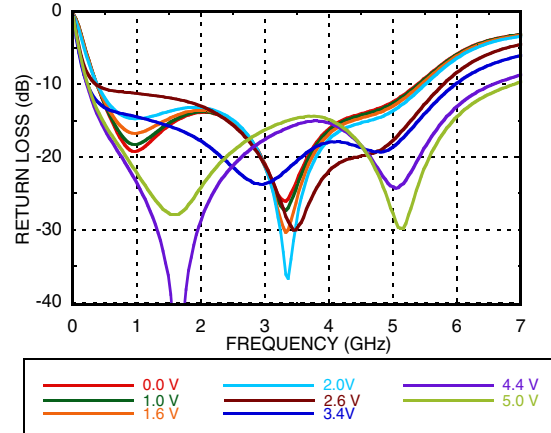

Output Return Loss Over Temperature (Vctrl = 0) @ VDD=5 V

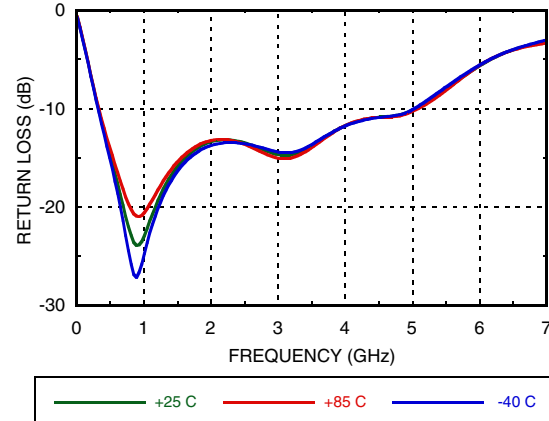

Output Return Loss Over Vctrl @ VDD=5 V

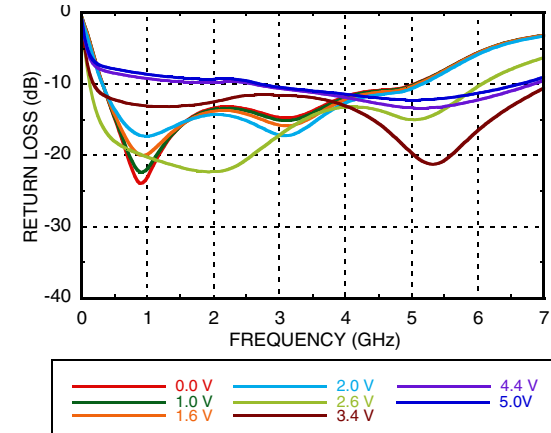

Input IP3 Vs Frequency Over Vctrl @ VDD=5 V

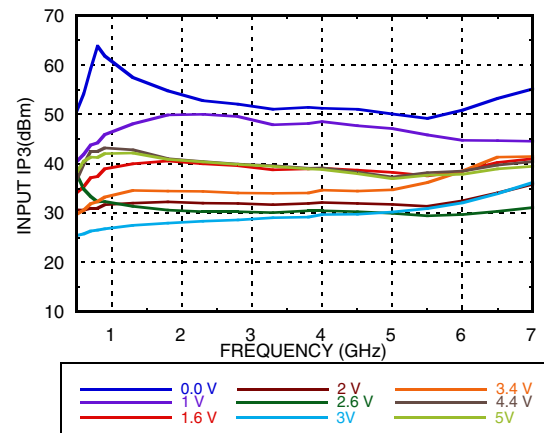

Input IP3 Over Temperature (Vctrl = 0V) @ VDD=5 V

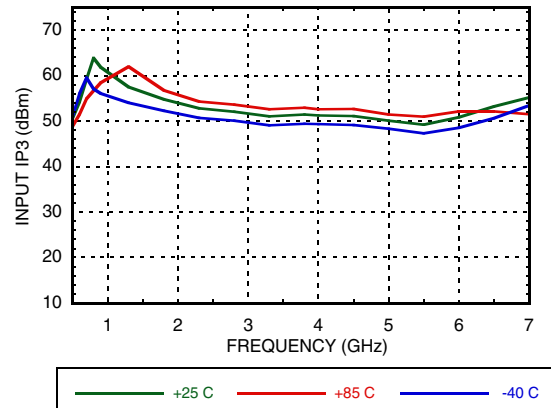

GAAS MMIC VOLTAGE VARIABLE ATTENUATOR, 0.5 - 5.0 GHz

Insertion Loss vs. Frequency Over Temperature @ 3 V

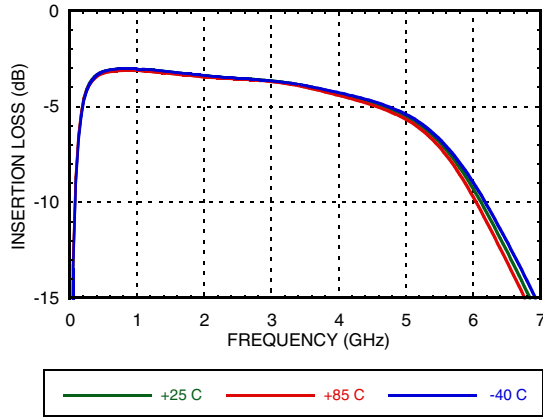

Attenuation vs. Frequency Over Vctrl @ 3 V

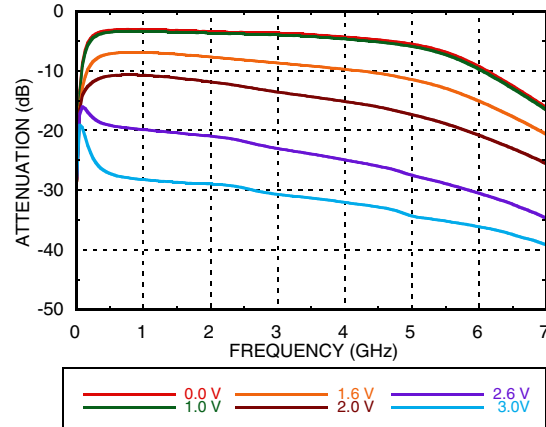

Attenuation vs. Vctrl Over Temperature @ 0.5 GHz and 3 V

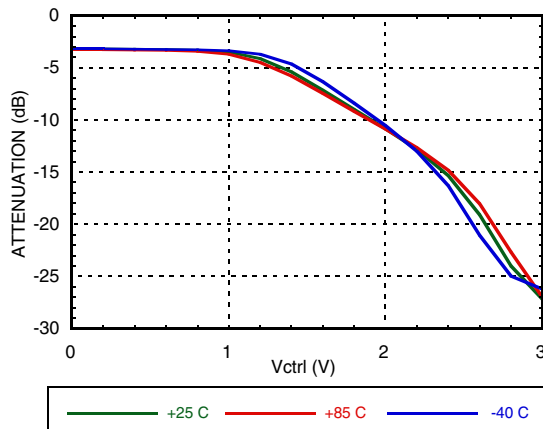

Attenuation vs. Vctrl Over Temperature @ 2 GHz and 3 V

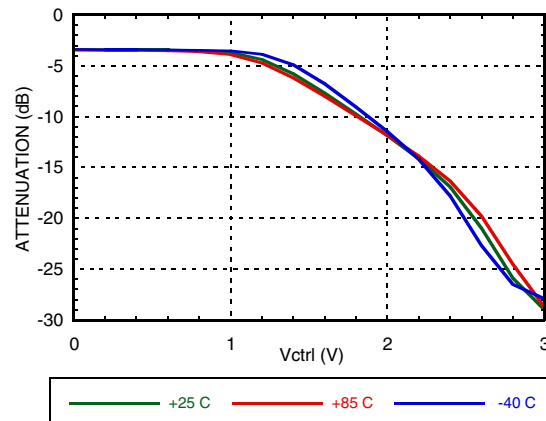

Attenuation vs. Vctrl Over Temperature @ 4 GHz and 3 V

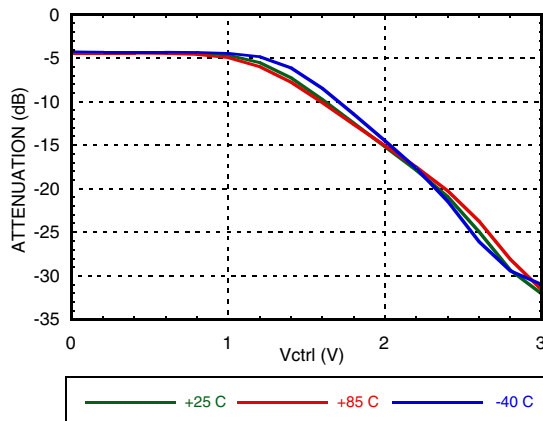

Attenuation vs. Vctrl Over Temperature @ 5 GHz and 3 V

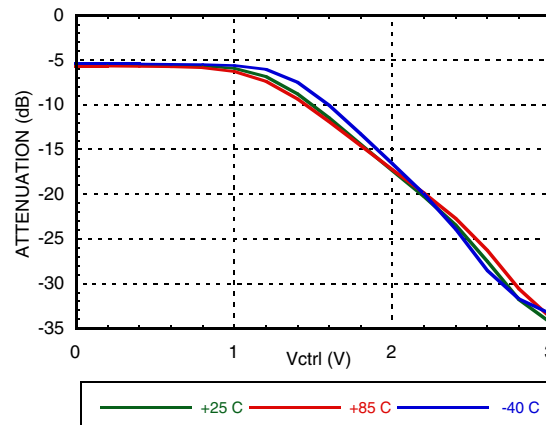

GAAS MMIC VOLTAGE VARIABLE ATTENUATOR, 0.5 - 5.0 GHz

Input Return Loss Over Temperature (Vctrl = 0) @ VDD=3 V

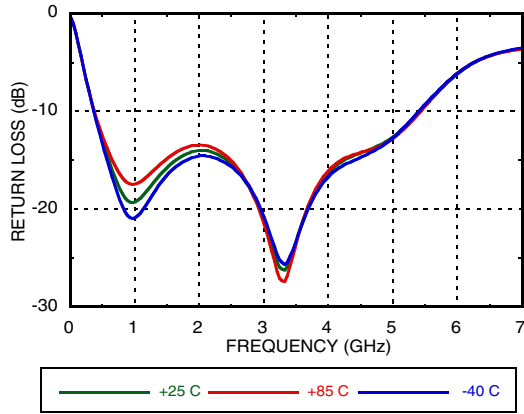

Input Return Loss Over Vctrl @ VDD=3 V

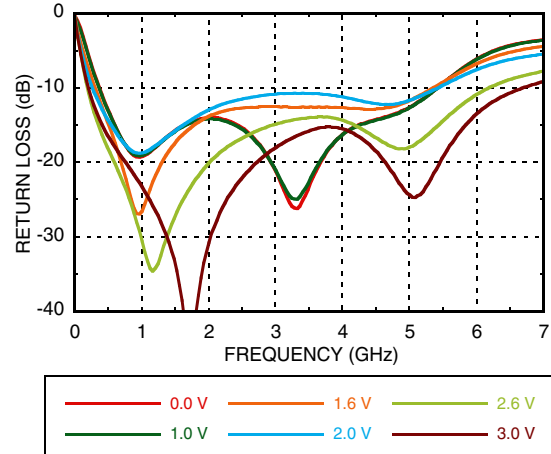

Output Return Loss Over Temperature (Vctrl = 0) @ VDD=3 V

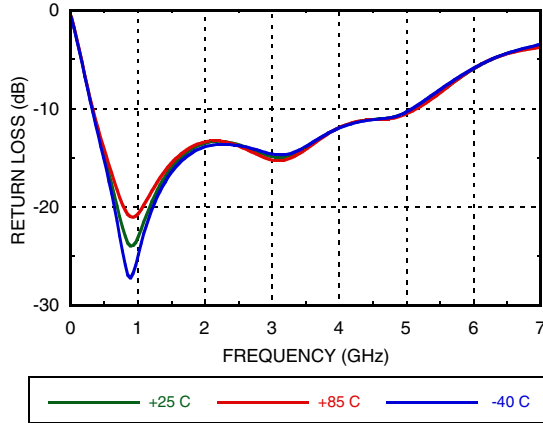

Output Return Loss Over Vctrl @ VDD=3 V

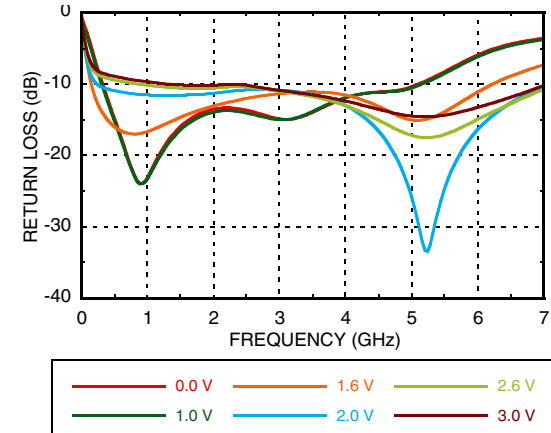

Input IP3 Vs Frequency Over Vctrl @ VDD=3 V

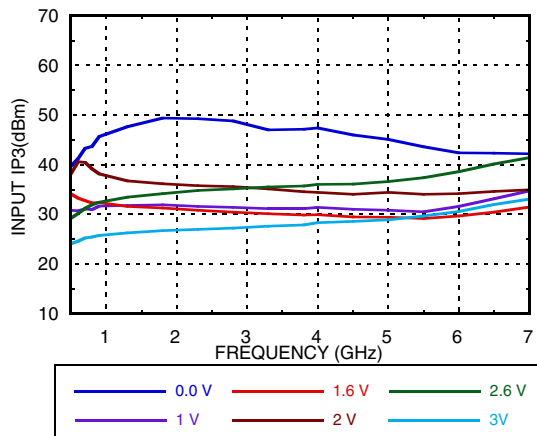

Input IP3 Over Temperature (Vctrl = 0V) @ VDD=3 V

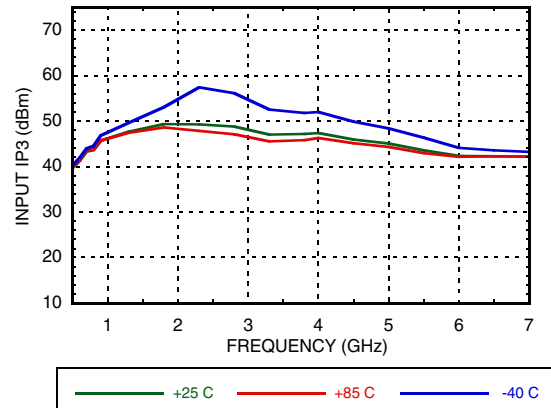

GAAS MMIC VOLTAGE VARIABLE ATTENUATOR, 0.5 - 5.0 GHz

Absolute Maximum Ratings

RF Input Power	+29 dBm
Vdd	5.5V
Control Voltage Range	-0.5V to Vdd
Channel Temperature	150 °C
Continuous P _{diss} (T = 85 °C)	0.8W
Thermal Resistance (Channel to ground paddle)	35 C/W
Storage Temperature	-65 to +150 °C
Operating Temperature	-40 to +85 °C
ESD Sensitivity (HBM)	Class 1A

Voltages & Currents

Vdd	5V @ 600 μA
Vctrl	0 to +5V @ 2.6mA



ELECTROSTATIC SENSITIVE DEVICE
OBSERVE HANDLING PRECAUTIONS

Outline Drawing

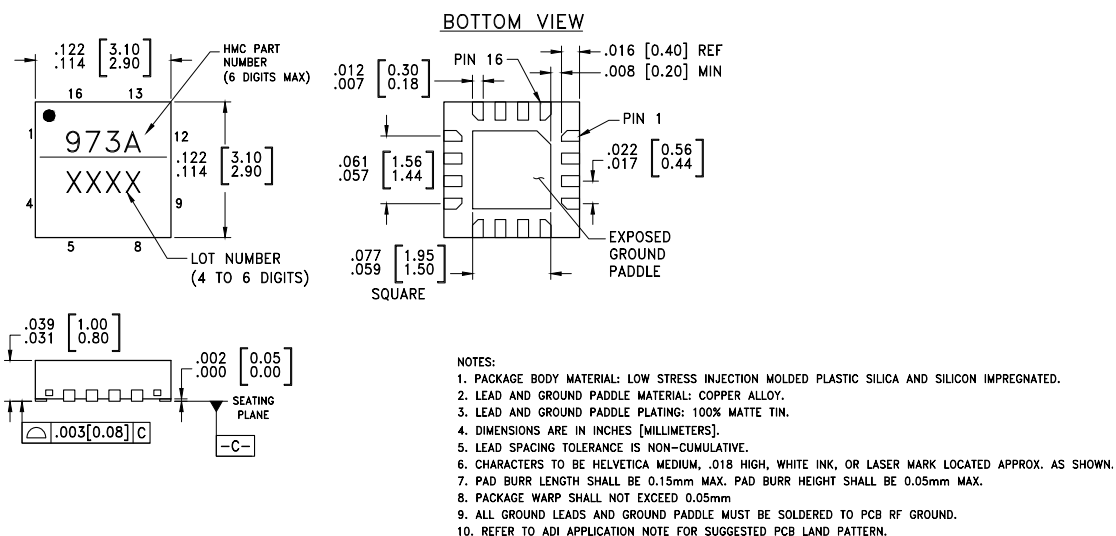

Package Information

Part Number	Package Body Material	Lead Finish	MSL Rating	Package Marking ^[1]
HMC973ALP3E	RoHS-compliant Low Stress Injection Molded Plastic	100% matte Sn	MSL3 ^[2]	973A XXXX

[1] 4-Digit lot number XXXX

[2] Max peak reflow temperature of 260 °C

For price, delivery, and to place orders: Analog Devices, Inc., One Technology Way, P.O. Box 9106, Norwood, MA 02062-9106
Phone: 781-329-4700 • Order online at www.analog.com
Application Support: Phone: 1-800-ANALOG-D

GAAS MMIC VOLTAGE VARIABLE ATTENUATOR, 0.5 - 5.0 GHz

Pin Descriptions

Pin Number	Function	Description	Interface Schematic
GND Paddle	GND	The exposed ground paddle must be connected to RF/DC ground.	
3	RFOUT	This pin is DC coupled and matched to 50 Ohms. A blocking capacitor is required if RF line potential is not equal to 0V.	
5	Vdd	Supply Voltage	
1,2,4,6, 8, 9, 11- 16	N/C	The pins are not connected internally; however, all data shown herein was measured with these pins connected to RF/DC ground externally.	
7	Vctrl	Control Voltage	
10	RFIN	This pin is DC coupled and matched to 50 Ohms. A blocking capacitor is required if RF line potential is not equal to 0V. The HMC973ALP3E is a unidirectional device with optimum linearity performance achieved with RF input signal applied to RFIN package lead.	

Application Circuit

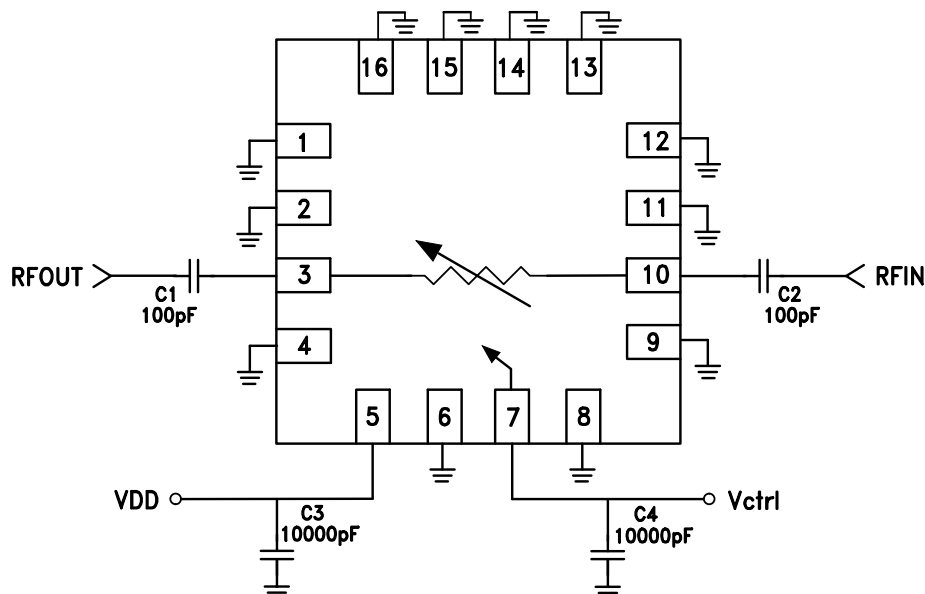

**GAAS MMIC VOLTAGE VARIABLE
ATTENUATOR, 0.5 - 5.0 GHz**

Evaluation PCB

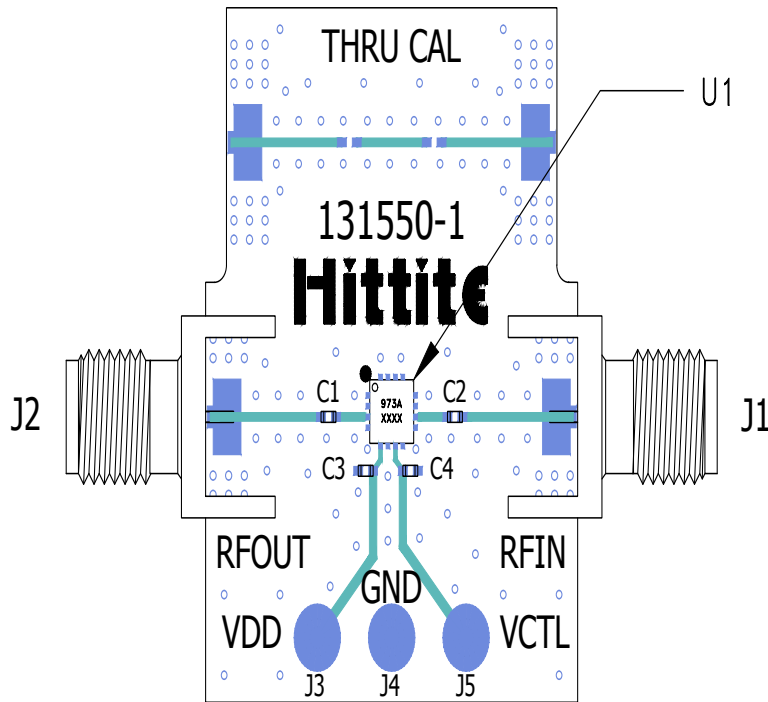

List of Materials for Evaluation PCB EV1HMC973ALP3 [1]

Item	Description
J1, J2	PCB Mount SMA RF Connector
J3 - J5	DC Pin
C1, C2	100 pF Capacitor, 0402 Pkg.
C3, C4	10000 pF Capacitor, 0402 Pkg.
U1	HMC973ALP3E Voltage Variable Attenuator
PCB [2]	131550 Evaluation PCB

[1] Reference this number when ordering complete evaluation PCB

[2] Circuit Board Material: Arlon 25FR or Rogers 4350

The circuit board used in the application should use RF circuit design techniques. Signal lines should have 50 Ohm impedance while the package ground leads and exposed paddle should be connected directly to the ground plane similar to that shown. A sufficient number of via holes should be used to connect the top and bottom ground planes. The evaluation circuit board shown is available from Analog Devices upon request.



Стандарт Электрон Связь

Мы молодая и активно развивающаяся компания в области поставок электронных компонентов. Мы поставляем электронные компоненты отечественного и импортного производства напрямую от производителей и с крупнейших складов мира.

Благодаря сотрудничеству с мировыми поставщиками мы осуществляем комплексные и плановые поставки широчайшего спектра электронных компонентов.

Собственная эффективная логистика и склад в обеспечивает надежную поставку продукции в точно указанные сроки по всей России.

Мы осуществляем техническую поддержку нашим клиентам и предпродажную проверку качества продукции. На все поставляемые продукты мы предоставляем гарантию .

Осуществляем поставки продукции под контролем ВП МО РФ на предприятия военно-промышленного комплекса России , а также работаем в рамках 275 ФЗ с открытием отдельных счетов в уполномоченном банке. Система менеджмента качества компании соответствует требованиям ГОСТ ISO 9001.

Минимальные сроки поставки, гибкие цены, неограниченный ассортимент и индивидуальный подход к клиентам являются основой для выстраивания долгосрочного и эффективного сотрудничества с предприятиями радиоэлектронной промышленности, предприятиями ВПК и научно-исследовательскими институтами России.

С нами вы становитесь еще успешнее!

Наши контакты:

Телефон: +7 812 627 14 35

Электронная почта: sales@st-electron.ru

Адрес: 198099, Санкт-Петербург,
Промышленная ул, дом № 19, литера Н,
помещение 100-Н Офис 331