

## 2N4401

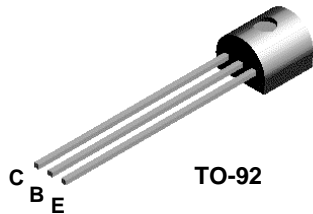

## MMBT4401

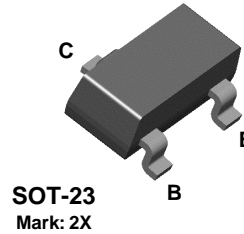

### NPN General Purpose Amplifier

This device is designed for use as a medium power amplifier and switch requiring collector currents up to 500 mA.

#### Absolute Maximum Ratings\*

TA = 25°C unless otherwise noted

Symbol	Parameter	Value	Units
V <sub>CEO</sub>	Collector-Emitter Voltage	40	V
V <sub>CBO</sub>	Collector-Base Voltage	60	V
V <sub>EBO</sub>	Emitter-Base Voltage	6.0	V
I <sub>C</sub>	Collector Current - Continuous	600	mA
T <sub>J</sub> , T <sub>stg</sub>	Operating and Storage Junction Temperature Range	-55 to +150	°C

\*These ratings are limiting values above which the serviceability of any semiconductor device may be impaired.

#### NOTES:

- 1) These ratings are based on a maximum junction temperature of 150 degrees C.
- 2) These are steady state limits. The factory should be consulted on applications involving pulsed or low duty cycle operations.

#### Thermal Characteristics

TA = 25°C unless otherwise noted

Symbol	Characteristic	Max		Units
		2N4401	*MMBT4401	
P <sub>D</sub>	Total Device Dissipation	625	350	mW
	Derate above 25°C	5.0	2.8	mW/°C
R <sub>θJC</sub>	Thermal Resistance, Junction to Case	83.3		°C/W
R <sub>θJA</sub>	Thermal Resistance, Junction to Ambient	200	357	°C/W

\*Device mounted on FR-4 PCB 1.6" X 1.6" X 0.06."

# NPN General Purpose Amplifier

(continued)

2N4401 / MMBT4401

## Electrical Characteristics

TA = 25°C unless otherwise noted

Symbol	Parameter	Test Conditions	Min	Max	Units
--------	-----------	-----------------	-----	-----	-------

### OFF CHARACTERISTICS

$V_{(BR)CEO}$	Collector-Emitter Breakdown Voltage*	$I_C = 1.0 \text{ mA}, I_B = 0$	40		V
$V_{(BR)CBO}$	Collector-Base Breakdown Voltage	$I_C = 0.1 \text{ mA}, I_E = 0$	60		V
$V_{(BR)EBO}$	Emitter-Base Breakdown Voltage	$I_E = 0.1 \text{ mA}, I_C = 0$	6.0		V
$I_{BL}$	Base Cutoff Current	$V_{CE} = 35 \text{ V}, V_{EB} = 0.4 \text{ V}$		0.1	$\mu\text{A}$
$I_{CEX}$	Collector Cutoff Current	$V_{CE} = 35 \text{ V}, V_{EB} = 0.4 \text{ V}$		0.1	$\mu\text{A}$

### ON CHARACTERISTICS\*

$h_{FE}$	DC Current Gain	$I_C = 0.1 \text{ mA}, V_{CE} = 1.0 \text{ V}$ $I_C = 1.0 \text{ mA}, V_{CE} = 1.0 \text{ V}$ $I_C = 10 \text{ mA}, V_{CE} = 1.0 \text{ V}$ $I_C = 150 \text{ mA}, V_{CE} = 1.0 \text{ V}$ $I_C = 500 \text{ mA}, V_{CE} = 2.0 \text{ V}$	20 40 80 100 40	300	
$V_{CE(sat)}$	Collector-Emitter Saturation Voltage	$I_C = 150 \text{ mA}, I_B = 15 \text{ mA}$ $I_C = 500 \text{ mA}, I_B = 50 \text{ mA}$		0.4 0.75	V
$V_{BE(sat)}$	Base-Emitter Saturation Voltage	$I_C = 150 \text{ mA}, I_B = 15 \text{ mA}$ $I_C = 500 \text{ mA}, I_B = 50 \text{ mA}$	0.75	0.95 1.2	V

### SMALL SIGNAL CHARACTERISTICS

$f_T$	Current Gain - Bandwidth Product	$I_C = 20 \text{ mA}, V_{CE} = 10 \text{ V},$ $f = 100 \text{ MHz}$	250		MHz
$C_{cb}$	Collector-Base Capacitance	$V_{CB} = 5.0 \text{ V}, I_E = 0,$ $f = 140 \text{ kHz}$		6.5	pF
$C_{eb}$	Emitter-Base Capacitance	$V_{BE} = 0.5 \text{ V}, I_C = 0,$ $f = 140 \text{ kHz}$		30	pF
$h_{ie}$	Input Impedance	$I_C = 1.0 \text{ mA}, V_{CE} = 10 \text{ V},$ $f = 1.0 \text{ kHz}$	1.0	15	$k\Omega$
$h_{re}$	Voltage Feedback Ratio	$I_C = 1.0 \text{ mA}, V_{CE} = 10 \text{ V},$ $f = 1.0 \text{ kHz}$	0.1	8.0	$\times 10^{-4}$
$h_{fe}$	Small-Signal Current Gain	$I_C = 1.0 \text{ mA}, V_{CE} = 10 \text{ V},$ $f = 1.0 \text{ kHz}$	40	500	
$h_{oe}$	Output Admittance	$I_C = 1.0 \text{ mA}, V_{CE} = 10 \text{ V},$ $f = 1.0 \text{ kHz}$	1.0	30	$\mu\text{mhos}$

### SWITCHING CHARACTERISTICS

$t_d$	Delay Time	$V_{CC} = 30 \text{ V}, V_{EB} = 2 \text{ V},$		15	ns
$t_r$	Rise Time	$I_C = 150 \text{ mA}, I_{B1} = 15 \text{ mA}$		20	ns
$t_s$	Storage Time	$V_{CC} = 30 \text{ V}, I_C = 150 \text{ mA}$		225	ns
$t_f$	Fall Time	$I_{B1} = I_{B2} = 15 \text{ mA}$		30	ns

\*Pulse Test: Pulse Width  $\leq 300 \mu\text{s}$ , Duty Cycle  $\leq 2.0\%$

Typical Characteristics

Typical Pulsed Current Gain vs Collector Current

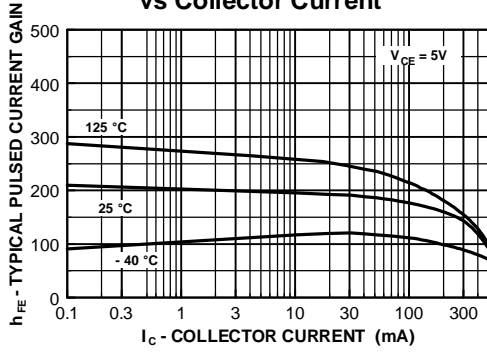

Collector-Emitter Saturation Voltage vs Collector Current

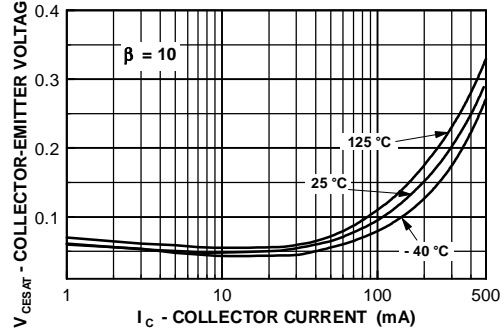

Base-Emitter Saturation Voltage vs Collector Current

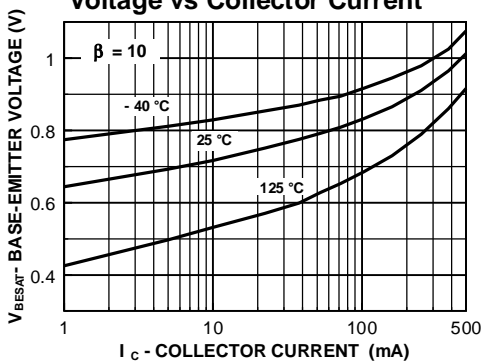

Base-Emitter ON Voltage vs Collector Current

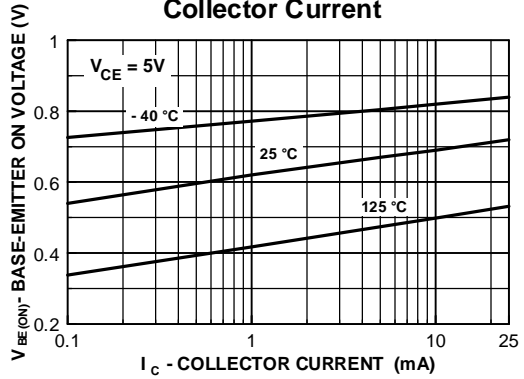

Collector-Cutoff Current vs Ambient Temperature

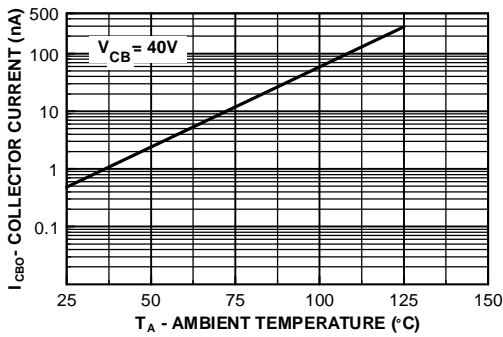

Emitter Transition and Output Capacitance vs Reverse Bias Voltage

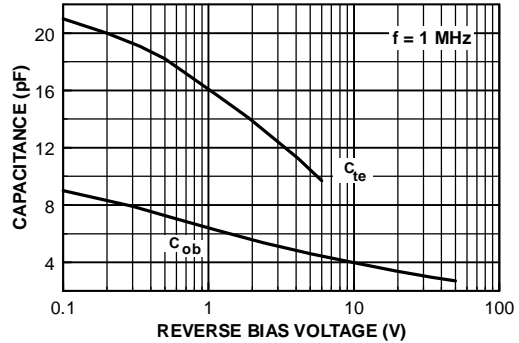

# NPN General Purpose Amplifier

(continued)

2N4401 / MMBT4401

## Typical Characteristics (continued)

**Turn On and Turn Off Times vs Collector Current**

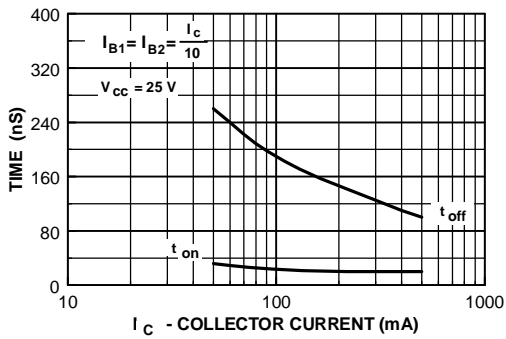

**Switching Times vs Collector Current**

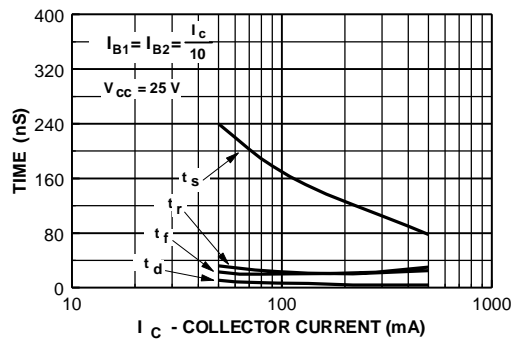

**Power Dissipation vs Ambient Temperature**

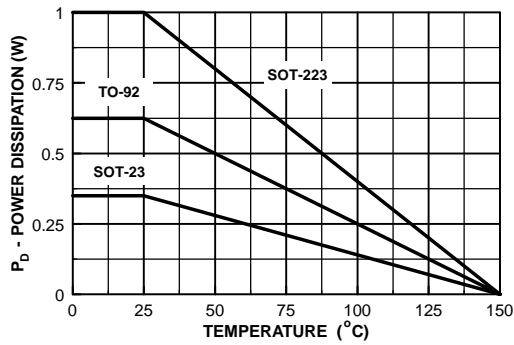

NPN General Purpose Amplifier  
(continued)

2N4401 / MMBT4401

Typical Common Emitter Characteristics (f = 1.0kHz)

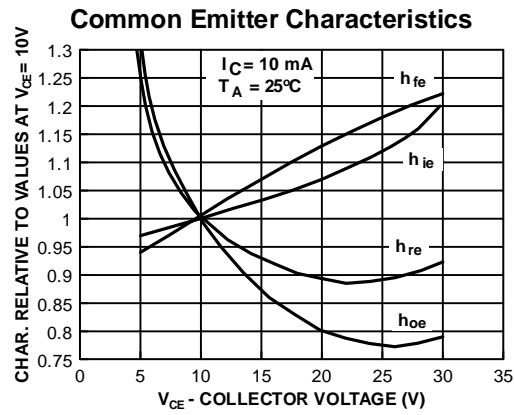
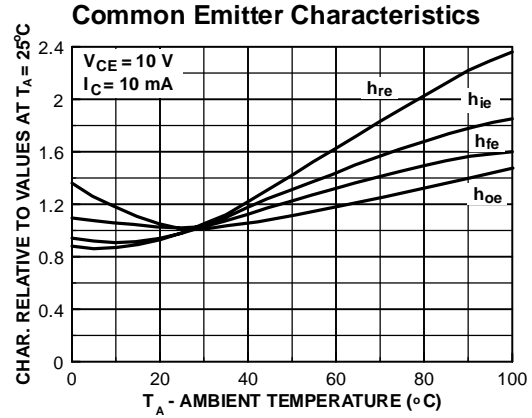
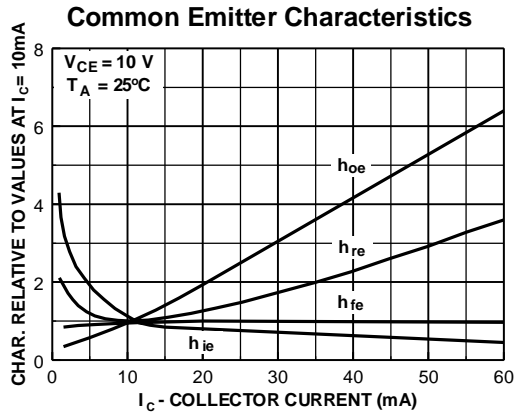

Test Circuits



FIGURE 1: Saturated Turn-On Switching Timer

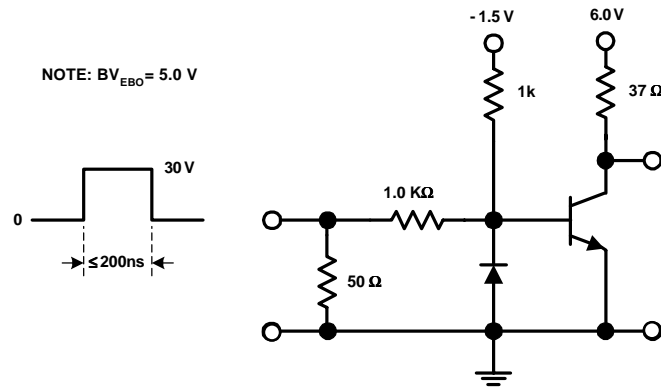

FIGURE 2: Saturated Turn-Off Switching Time

## TRADEMARKS

The following are registered and unregistered trademarks Fairchild Semiconductor owns or is authorized to use and is not intended to be an exhaustive list of all such trademarks.

ACE <sup>x</sup> <sup>TM</sup>	FAST <sup>r</sup> <sup>TM</sup>	PowerTrench <sup>®</sup>	SyncFET <sup>TM</sup>
Bottomless <sup>TM</sup>	GlobalOptoisolator <sup>TM</sup>	QFET <sup>TM</sup>	TinyLogic <sup>TM</sup>
CoolFET <sup>TM</sup>	GTO <sup>TM</sup>	QS <sup>TM</sup>	UHC <sup>TM</sup>
CROSSVOLT <sup>TM</sup>	HiSeC <sup>TM</sup>	QT Optoelectronics <sup>TM</sup>	VCX <sup>TM</sup>
DOME <sup>TM</sup>	ISOPLANAR <sup>TM</sup>	Quiet Series <sup>TM</sup>	
E <sup>2</sup> CMOS <sup>TM</sup>	MICROWIRE <sup>TM</sup>	SILENT SWITCHER <sup>®</sup>	
EnSigna <sup>TM</sup>	OPTOLOGIC <sup>TM</sup>	SMART START <sup>TM</sup>	
FACT <sup>TM</sup>	OPTOPLANAR <sup>TM</sup>	SuperSOT <sup>TM</sup> -3	
FACT Quiet Series <sup>TM</sup>	PACMAN <sup>TM</sup>	SuperSOT <sup>TM</sup> -6	
FAST <sup>®</sup>	POP <sup>TM</sup>	SuperSOT <sup>TM</sup> -8	

## DISCLAIMER

FAIRCHILD SEMICONDUCTOR RESERVES THE RIGHT TO MAKE CHANGES WITHOUT FURTHER NOTICE TO ANY PRODUCTS HEREIN TO IMPROVE RELIABILITY, FUNCTION OR DESIGN. FAIRCHILD DOES NOT ASSUME ANY LIABILITY ARISING OUT OF THE APPLICATION OR USE OF ANY PRODUCT OR CIRCUIT DESCRIBED HEREIN; NEITHER DOES IT CONVEY ANY LICENSE UNDER ITS PATENT RIGHTS, NOR THE RIGHTS OF OTHERS.

## LIFE SUPPORT POLICY

FAIRCHILD'S PRODUCTS ARE NOT AUTHORIZED FOR USE AS CRITICAL COMPONENTS IN LIFE SUPPORT DEVICES OR SYSTEMS WITHOUT THE EXPRESS WRITTEN APPROVAL OF FAIRCHILD SEMICONDUCTOR CORPORATION. As used herein:

1. Life support devices or systems are devices or systems which, (a) are intended for surgical implant into the body, or (b) support or sustain life, or (c) whose failure to perform when properly used in accordance with instructions for use provided in the labeling, can be reasonably expected to result in significant injury to the user.
2. A critical component is any component of a life support device or system whose failure to perform can be reasonably expected to cause the failure of the life support device or system, or to affect its safety or effectiveness.

## PRODUCT STATUS DEFINITIONS

### Definition of Terms

Datasheet Identification	Product Status	Definition
Advance Information	Formative or In Design	This datasheet contains the design specifications for product development. Specifications may change in any manner without notice.
Preliminary	First Production	This datasheet contains preliminary data, and supplementary data will be published at a later date. Fairchild Semiconductor reserves the right to make changes at any time without notice in order to improve design.
No Identification Needed	Full Production	This datasheet contains final specifications. Fairchild Semiconductor reserves the right to make changes at any time without notice in order to improve design.
Obsolete	Not In Production	This datasheet contains specifications on a product that has been discontinued by Fairchild semiconductor. The datasheet is printed for reference information only.



## Стандарт Электрон Связь

Мы молодая и активно развивающаяся компания в области поставок электронных компонентов. Мы поставляем электронные компоненты отечественного и импортного производства напрямую от производителей и с крупнейших складов мира.

Благодаря сотрудничеству с мировыми поставщиками мы осуществляем комплексные и плановые поставки широчайшего спектра электронных компонентов.

Собственная эффективная логистика и склад в обеспечивает надежную поставку продукции в точно указанные сроки по всей России.

Мы осуществляем техническую поддержку нашим клиентам и предпродажную проверку качества продукции. На все поставляемые продукты мы предоставляем гарантию .

Осуществляем поставки продукции под контролем ВП МО РФ на предприятия военно-промышленного комплекса России , а также работаем в рамках 275 ФЗ с открытием отдельных счетов в уполномоченном банке. Система менеджмента качества компании соответствует требованиям ГОСТ ISO 9001.

Минимальные сроки поставки, гибкие цены, неограниченный ассортимент и индивидуальный подход к клиентам являются основой для выстраивания долгосрочного и эффективного сотрудничества с предприятиями радиоэлектронной промышленности, предприятиями ВПК и научно-исследовательскими институтами России.

С нами вы становитесь еще успешнее!

### Наши контакты:

**Телефон:** +7 812 627 14 35

**Электронная почта:** [sales@st-electron.ru](mailto:sales@st-electron.ru)

**Адрес:** 198099, Санкт-Петербург,  
Промышленная ул, дом № 19, литера Н,  
помещение 100-Н Офис 331