

## TLV320AIC3107EVM-K

This user's guide describes the characteristics, operation, and use of the TLV320AIC3107EVM-K. This evaluation module (EVM) allows the user to evaluate the TLV320AIC3107 audio codec. The TLV320AIC3107 is a complete 2-channel audio codec with an integrated Class-D speaker amplifier. It also has many inputs and outputs, extensive audio routing, mixing, and effects capabilities. A complete circuit description, schematic diagram, and bill of materials are included. Note that the TLV320AIC3107 only uses the I<sup>2</sup>C™ bus for register control. Any references to the SPI control bus in this document is due to the presence of this interface on the USB-MODEVM motherboard.

---

**Note:** For a quick start, go directly to [Section 3.1](#) Software Installation, followed by [Section 3.2](#) EVM Connections, and then to [Section 4.1](#) Quick Start Tabs.

---

The following related documents are available through the Texas Instruments Web site at [www.ti.com](http://www.ti.com).

### EVM-Compatible Device Data Sheets

| Device        | Literature Number       |
|---------------|-------------------------|
| TLV320AIC3107 | <a href="#">SLOS545</a> |
| TAS1020B      | <a href="#">SLES025</a> |
| REG1117-3.3   | <a href="#">SBVS001</a> |
| TPS767D318    | <a href="#">SLVS209</a> |
| SN74LVC125A   | <a href="#">SCAS290</a> |
| SN74LVC1G125  | <a href="#">SCES223</a> |
| SN74LVC1G07   | <a href="#">SCES296</a> |

### Contents

|            |   |    |
|------------|---|----|
| 1          | EVM Overview .....                              | 3  |
| 2          | EVM Description and Basics .....                | 3  |
| 3          | TLV320AIC3107EVM-K Setup and Installation ..... | 7  |
| 4          | TLV320AIC3107EVM Software .....                 | 8  |
| Appendix A | EVM Connector Descriptions .....                | 33 |
| Appendix B | TLV320AIC3107EVM Schematic .....                | 36 |
| Appendix C | TLV320AIC3107EVM Layout Views .....             | 38 |
| Appendix D | TLV320AIC3107EVM Bill of Materials .....        | 41 |
| Appendix E | USB-MODEVM Schematic .....                      | 43 |
| Appendix F | USB-MODEVM Bill of Materials .....              | 44 |
| Appendix G | USB-MODEVM Protocol .....                       | 46 |

### List of Figures

|   |   |    |
|---|---|----|
| 1 | TLV320AIC3107EVM-K Block Diagram .....        | 4  |
| 2 | Quick Start - USB-MODEM Configurations .....  | 8  |
| 3 | Quick Start - Preset Configurations Tab ..... | 9  |
| 4 | Main Software Screen .....                    | 10 |
| 5 | .....   | 11 |
| 6 | Audio Input/ADC Tab .....                     | 12 |

I<sup>2</sup>C, I<sup>2</sup>S are trademarks of Koninklijke Philips Electronics N.V..  
Windows is a trademark of Microsoft Corporation.  
LabView is a trademark of National Instruments.

|     |                                      |    |
|-----|--------------------------------------|----|
| 7   | Bypass Paths Tab .....               | 13 |
| 8   | Audio Interface Tab .....            | 14 |
| 9   | Clocks Tab .....                     | 15 |
| 10  | GPIO1 Tab .....                      | 17 |
| 11  | AGC Tab .....                        | 18 |
| 12  | Left AGC Settings .....              | 19 |
| 13  | Advanced .....                       | 19 |
| 14  | Filters Tab .....                    | 20 |
| 15  | ADC High-Pass Filters .....          | 21 |
| 16  | ADC High-Pass Filter Settings .....  | 21 |
| 17  | DAC Filters .....                    | 22 |
| 18  | De-emphasis Filters .....            | 22 |
| 19  | Enabling Filters .....               | 23 |
| 20  | Shelf Filters .....                  | 23 |
| 21  | EQ Filters .....                     | 24 |
| 22  | Analog Simulation Filters .....      | 24 |
| 23  | Preset Filters .....                 | 25 |
| 24  | User Filters .....                   | 25 |
| 25  | 3D Effect Settings .....             | 26 |
| 26  | DAC/Line Outputs Tab .....           | 26 |
| 27  | Output Stage Configuration Tab ..... | 28 |
| 28  | High Power Outputs Tab .....         | 29 |
| 29  | Class-D Output Tab .....             | 30 |
| 30  | Command Line Interface Tab .....     | 31 |
| 31  | File Menu .....                      | 32 |
| C-1 | Assembly layer .....                 | 38 |
| C-2 | Top Layer .....                      | 38 |
| C-3 | Layer 3 .....                        | 39 |
| C-4 | Layer 4 .....                        | 39 |
| C-5 | Bottom Layer .....                   | 40 |

#### List of Tables

|     |  |    |
|-----|--|----|
| 1   | USB-MODEVM SW2 Settings .....                      | 5  |
| 2   | List of Stand-alone Jumpers .....                  | 5  |
| 3   | Switch SW1 Configurations .....                    | 6  |
| 4   | Switch SW2 Configurations .....                    | 6  |
| 5   | Switch SW3 Configurations .....                    | 6  |
| A-1 | Analog Input/Output Connectors .....               | 33 |
| A-2 | Block A and Block B Digital Interface Pinout ..... | 34 |
| A-3 | Power Supply Pinout .....                          | 35 |
| D-1 | TLV320AIC3107EVM Bill of Materials .....           | 41 |
| F-1 | USB-MODEVM Bill of Materials .....                 | 44 |
| G-1 | USB Control Endpoint HIDSETREPORT Request .....    | 46 |
| G-2 | Data Packet Configuration .....                    | 46 |
| G-3 | GPIO Pin Assignments .....                         | 49 |

## 1 EVM Overview

### 1.1 Features

- Full-featured evaluation board for the TLV320AIC3107 2-channel audio codec with integrated Class-D amplifier.
- Modular design for use with a variety of digital signal processor (DSP) and microcontroller interface boards.
- USB connection to PC provides power, control, and streaming audio data for easy evaluation.
- Onboard microphone for ADC evaluation
- Connection points for external control and digital audio signals for quick connection to other circuits/input devices.

The TLV320AIC3107EVM-K is a complete evaluation kit, which includes a universal serial bus (USB)-based motherboard and evaluation software for use with a personal computer (PC) running the Microsoft Windows™ operating system (Win2000 or XP).

### 1.2 Introduction

The TLV320AIC3107EVM is in the Texas Instruments modular EVM form factor, which allows direct evaluation of the device performance and operating characteristics, and eases software development and system prototyping. This EVM is compatible with the 5-6K Interface Evaluation Module ([SLAU104](#)) and the HPA-MCUINTERFACE ([SLAU106](#)) from Texas Instruments and additional third-party boards which supports the TI Modular EVM format.

The TLV320AIC3107EVM-K is a complete evaluation/demonstration kit, which includes a USB-based motherboard called the USB-MODEVM Interface board and evaluation software for use with a PC running the Microsoft Windows operating systems.

The USB connection from the PC provides power, control, and streaming audio data to the EVM for reduced setup and configuration. The EVM also allows external control signals, audio data, and power for advanced operation, which allows prototyping and connection to the rest of the evaluation/development system.

## 2 EVM Description and Basics

This section provides information on the analog input and output, digital control, power, and general connection of the TLV320AIC3107EVM.

### 2.1 TLV320AIC3107EVM-K Block Diagram

The TLV320AIC3107EVM-K consists of two separate circuit boards, the USB-MODEVM and the TLV320AIC3107EVM. The USB-MODEVM is built around a TAS1020B streaming audio USB controller with an 8051-based core.

The simple diagram of [Figure 1](#) shows how the TLV320AIC3107EVM is connected to the USB-MODEVM. The USB-MODEVM Interface board is intended to be used in USB mode, whereas control of the installed EVM is accomplished using the onboard USB controller device. Provision is made, however, for driving all the data buses (I<sup>2</sup>C, I<sup>2</sup>S, etc.) externally. The source of these signals is controlled by SW2 on the USB-MODEVM. See [Table 1](#) for details on the switch settings.

### 2.1.1 USB-MODEVM Interface Board

The simple diagram of [Figure 1](#) shows only the basic features of the USB-MODEVM Interface board.

When connecting the TLV320AIC3107EVM to the USB-MODEVM, use care to avoid bending the connecting pins. The two boards can only be connected in one way. It is suggested to first align with the 10-pin connectors (J3 on the TLV320AIC3107EVM and J18A on the USB-MODEVM) and then gently push all the connectors together until the boards are seated.

In the factory configuration, the board is ready to use with the TLV320AIC3107EVM. To view all the functions and configuration options available on the USB-MODEVM board, see the USB-MODEVM Interface Board schematic in [Appendix E](#).

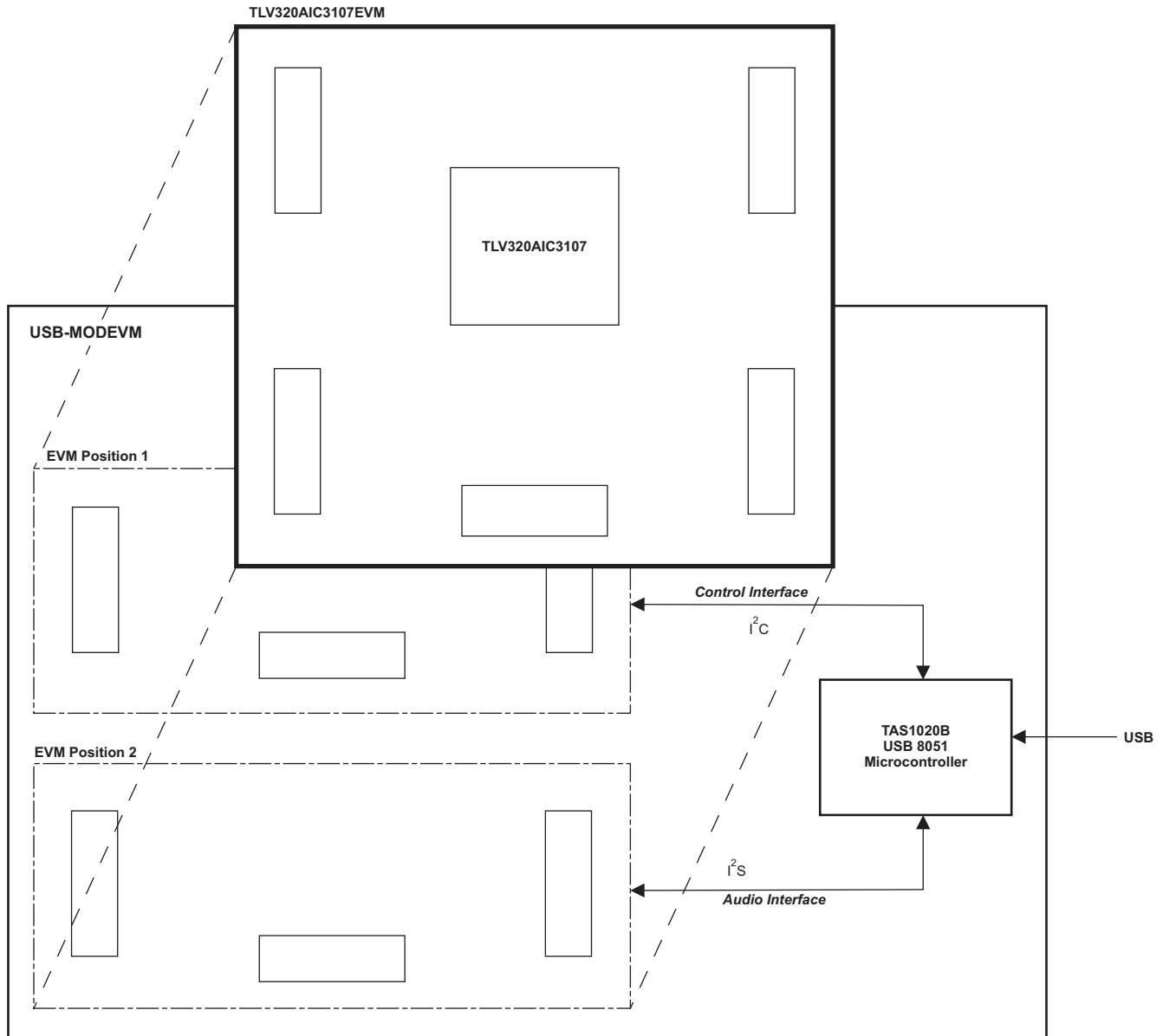

**Figure 1. TLV320AIC3107EVM-K Block Diagram**

## 2.2 Default Configuration and Connections

### 2.2.1 USB-MODEVM

Table 1 provides a list of the SW2 settings on the USB-MODEVM. For use with the TLV320AIC3107EVM, SW-2 positions 1 through 7 must be set to ON (LO), whereas SW-2.8 must be set to OFF (HI).

**Table 1. USB-MODEVM SW2 Settings**

| SW-2 Switch Number | Label                 | Switch Description  |
|--------------------|-----------------------|---|
| 1                  | A0                    | USB-MODEVM EEPROM I <sup>2</sup> C Address A0<br>ON: A0 = 0<br>OFF: A0 = 1  |
| 2                  | A1                    | USB-MODEVM EEPROM I <sup>2</sup> C Address A1<br>ON: A1 = 0<br>OFF: A1 = 1  |
| 3                  | A2                    | USB-MODEVM EEPROM I <sup>2</sup> C Address A2<br>ON: A2 = 0<br>OFF: A2 = 1  |
| 4                  | USB I <sup>2</sup> S™ | I <sup>2</sup> S Bus Source Selection<br>ON: I <sup>2</sup> S Bus connects to TAS1020<br>OFF: I <sup>2</sup> S Bus connects to USB-MODEVM J14 |
| 5                  | USB MCK               | I <sup>2</sup> S Bus MCLK Source Selection<br>ON: MCLK connects to TAS1020<br>OFF: MCLK connects to USB-MODEVM J14                            |
| 6                  | USB SPI               | SPI Bus Source Selection<br>ON: SPI Bus connects to TAS1020<br>OFF: SPI Bus connects to USB-MODEVM J15  |
| 7                  | USB RST               | RST Source Selection<br>ON: EVM Reset Signal comes from TAS1020<br>OFF: EVM Reset Signal comes from USB-MODEVM J15                            |
| 8                  | EXT MCK               | External MCLK Selection<br>ON: MCLK Signal is provided from USB-MODEVM J10<br>OFF: MCLK Signal comes from either selection of SW2-5           |

### 2.2.2 TLV320AIC3107EVM Jumpers and Switches

Table 2 provides a list of jumpers found on the EVM and their factory default conditions.

**Table 2. List of Stand-alone Jumpers**

| Jumper Number | Jumper Type | Default Position | Jumper Description  |
|---------------|-------------|------------------|---|
| W1            | 2-pin       | soldered         | AVDD_ADC power  |
| W2            | 2-pin       | soldered         | DRVDD power (DRVDD1 on EVM).  |
| W3            | 2-pin       | soldered         | DRVDD power (DRVDD2 on EVM).  |
| W3            | 2-pin       | soldered         | AVDD_DAC power.   |
| W5            | 2-pin       | soldered         | SPVDD power.  |
| W7            | 2-pin       | soldered         | DVDD power.   |
| W8            | 2-pin       | soldered         | IOVDD power.  |
| W9            | 3-pin       | 2-3              | Mic bias select. Connect 1-2 to use AIC3107 Mic Bias. Connect 2-3 to use EVM 3.3V Mic Bias. |
| W10           | 2-pin       | Open             | Connect EVM Onboard Mic to AIC3107 MIC3R input.   |
| W11           | 2-pin       | Open             | Connect EVM Onboard Mic to AIC3107 MIC3L input.   |
| W12           | 2-pin       | Open             | Enable 16-ohm load for HPL output test.   |
| W13           | 2-pin       | Open             | Enable 16-ohm load for HPR output test.   |
| W14           | 3-pin       | 1-2              | IOVDD select. Connect 1-2 for IOVDD=+1.8V. Connect 2-3 for IOVDD=+3.3V.                     |
| W15           | 2-pin       | Open             | GPIO1 access point.   |
| W16           | 2-pin       | Installed        | Software reset enable.  |

**Table 2. List of Stand-alone Jumpers (continued)**

| Jumper Number | Jumper Type | Default Position | Jumper Description   |
|---------------|-------------|------------------|--|
| W17           | 2-pin       | Open             | Selects onboard EEPROM as TAS1020B Firmware Source.(Not Used). Note that for this EVM the Firmware Source EEPROM is on the USB-MODEVM. |
| W18           | 2-pin       | Open             | Selects SWOUTP to J-18. Caution: Make sure that the Class-D Output is Disabled before Installing W18.                                  |
| W19           | 2-pin       | Open             | Selects SWOUTM to J-18. Caution: Make sure that the Class-D Output is Disabled before Installing W19.                                  |

**Table 3. Switch SW1 Configurations**

| EVM Connector | Connector Terminal Number (Terminal 2 is always Ground.) | SW1 Switch Position = DIFF (Differential Inputs) | SW1 Switch Position = SE = Single-Ended Inputs  |
|---------------|--|--|---|
| J6            | Terminal 1   | Input to AIC3107-pin 4 = <b>LINE1LP</b>          | Input to AIC3107-pin 4 = <b>LINE1LP</b>         |
|               | Terminal 3   | Input to AIC3107-pin 3 = <b>MICDET/LINE1LM</b>   | Input to AIC3107-pin 5 = <b>LINE1RP</b>         |
| J7            | Terminal 1   | Input to AIC3107-pin 5 = <b>LINE1RP</b>          | Input to AIC3107-pin 9 = <b>MIC3R/LINE2RM</b>   |
|               | Terminal 3   | Input to AIC3107-pin 6 = <b>MIC3L/LINE1RM</b>    | Input to AIC3107-pin 6 = <b>MIC3L/LINE1RM</b>   |
| J8            | Terminal 1   | Input to AIC3107-pin 7 = <b>LINE2LP</b>          | Input to AIC3107-pin 7 = <b>LINE2LP</b>         |
|               | Terminal 3   | Input to AIC3107-pin 8 = <b>LINE2RP/LINE2LM</b>  | Input to AIC3107-pin 8 = <b>LINE2RP/LINE2LM</b> |

**Table 4. Switch SW2 Configurations**

| SW2 Switch Position = CAP   | SW2 Switch Position = Capacitor-less                          |
|---|---|
| 47- $\mu$ F capacitors in-line with HPLOUT and HPROUT to J10 (Referenced to Ground) | HPLOUT and HPROUT Direct Coupled to J10 (Referenced to HPCOM) |

**Table 5. Switch SW3 Configurations**

| SW3 Switch Position = EXT.  | SW3 Switch Position = +5VA                                      |
|---|---|
| User Provides an External Power Supply for SVDD (Class-D Power Amplifier Supply), Max Value = 5 VDC | EVM 5-VDC Supply used for SVDD (Class-D Power Amplifier Supply) |

## 2.3 Power Connections

The TLV320AIC3107 can be powered independently when being used in stand-alone operation or by the USB-MODEVM when it is plugged onto the motherboard.

### 2.3.1 Stand-Alone Operation

When used as a stand-alone, power is applied to J15 directly; be sure to reference the supplies to the appropriate grounds on that connector.

#### CAUTION

Before applying power to the EVM, you must verify that all power supplies are within the safe operating limits as indicated in the [TLV320AIC3107 data sheet](#).

J15 provides connection to the common power bus for the TLV320AIC3107EVM. Power is supplied on the pins listed in [Table A-3](#).

The TLV320AIC3107EVM-K motherboard (the USB-MODEVM Interface board) supplies power to J15 of the TLV320AIC3107EVM. Power for the motherboard is supplied either through its USB connection or via terminal blocks on that board.

### 2.3.2 USB-MODEVM Operation

The USB-MODEVM Interface board can be powered from several different sources:

- USB
- 6-Vdc to 10-Vdc ac/dc external wall supply (not included)

- Laboratory power supply

When powered from the USB connection, JMP6 must have a shunt from pins 1–2 (this is the default factory configuration). When powered from 6 Vdc–10 Vdc, either through the J8 terminal block or J9 barrel jack, JMP6 must have a shunt installed on pins 2–3. If power is applied in any of these ways, onboard regulators generate the required supply voltages, and no further power supplies are necessary.

If laboratory supplies are used to provide the individual voltages required by the USB-MODEVM Interface, JMP6 must have no shunt installed. Voltages are then applied to J2 (+5VA), J3 (+5VD), J4 (+1.8VD), and J5 (+3.3VD). The +1.8VD and +3.3VD can also be generated on the board by the onboard regulators from the +5VD supply; to enable this configuration, the switches on SW1 need to be set to enable the regulators by placing them in the ON position (lower position, looking at the board with text reading right-side up). If +1.8VD and +3.3VD are supplied externally, disable the onboard regulators by placing SW1 switches in the OFF position.

Each power supply voltage has an LED (D1–D7) that lights when the power supplies are active.

### 3 TLV320AIC3107EVM-K Setup and Installation

The following section provides information on using the TLV320AIC3107EVM-K, including set up, program installation, and program usage.

---

**Note:** If using the EVM in stand-alone mode, the software must be installed per the following instructions, but the hardware configuration may be different.

---

#### 3.1 Software Installation

1. Locate the installation file on the CD-ROM included with the EVM or download the latest version of the software located on the [AIC3107 Product Page](#).
2. Unzip the installation file by clicking on the self-extracting zip file.
3. Install the EVM software by double-clicking the **Setup** executable and follow the directions. Users may be prompted to restart their computers.

This installs all the TLV320AIC3107 software and required drivers onto the PC.

#### 3.2 EVM Connections

1. Ensure that the TLV320AIC3107EVM is installed on the USB-MODEVM Interface board, aligning J1, J2, J3, J4, and J5 with the corresponding connectors on the USB-MODEVM.
2. Verify that the jumpers and switches are in their default conditions.
3. Attach a USB cable from the PC to the USB-MODEVM Interface board. The default configuration provides power, control signals, and streaming audio via the USB interface from the PC. On the USB-MODEVM, LEDs D3–6 light to indicate the power is being supplied from the USB.
4. For the first connection, the PC recognizes new hardware and begins an initialization process. The user may be prompted to identify the location of the drivers or allow the PC to automatically search for them. Allow the automatic detection option.
5. Once the PC confirms that the hardware is operational, D2 on the USB-MODEVM lights to indicate that the firmware has been loaded and the EVM is ready for use. If the LED is not lighted, verify that the drivers were installed, try to unplug, and restart at Step 3.

After the TLV320AIC3107EVM-K software installation (described in [Section 3.2](#)) is complete, evaluation and development using the target TLV320AIC3107 can begin.

The TLV320AIC3107EVM software now can be launched. The user sees an initial screen that looks similar to [Figure 4](#).

## 4 TLV320AIC3107EVM Software

The following section discusses the details and operation of the EVM software.

**Note:** For configuration of the codec, the TLV320AIC3107 block diagram located in the [TLV320AIC3107](#) data sheet is a good reference to help determine the signal routing. A pop-up detailed block diagram also is provided in the TLV320AIC3107 GUI software.

### 4.1 Quick Start Tabs

The Quick Start USB-MODEM Configurations tab and The Quick Start Preset Configurations tab [Figure 3](#) helps the user to begin using the GUI.

#### 4.1.1 Quick Start - USB-MODEM Configurations

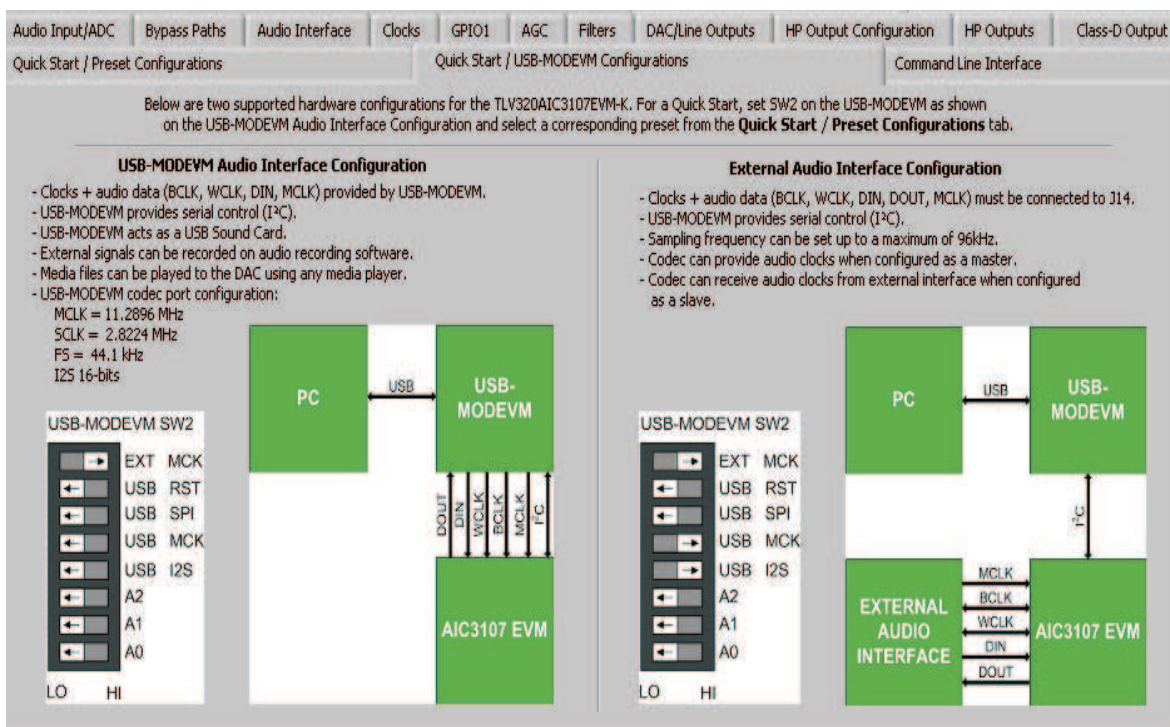

**Figure 2. Quick Start - USB-MODEM Configurations**

The default tab is the Quick Start - USB-MODEVM tab. This tab shows two common USB-MODEVM configurations used with the AIC3107EVM. The default configuration is the USB-MODEVM Audio Interface Configuration. In this configuration, the USB-MODEVM acts as a USB sound card. Audio files can be played on the PC and targeted to the USB-MODEVM via the USB connection. On the USB-MODEVM, the TAS1020B converts the USB audio to I<sup>2</sup>S data and the I<sup>2</sup>C script data to I<sup>2</sup>C commands.

**Note:** For correct EVM operation, ensure that SW2 switch settings are as shown in [Figure 2](#).



### 4.1.2 Quick Start - Preset Configurations

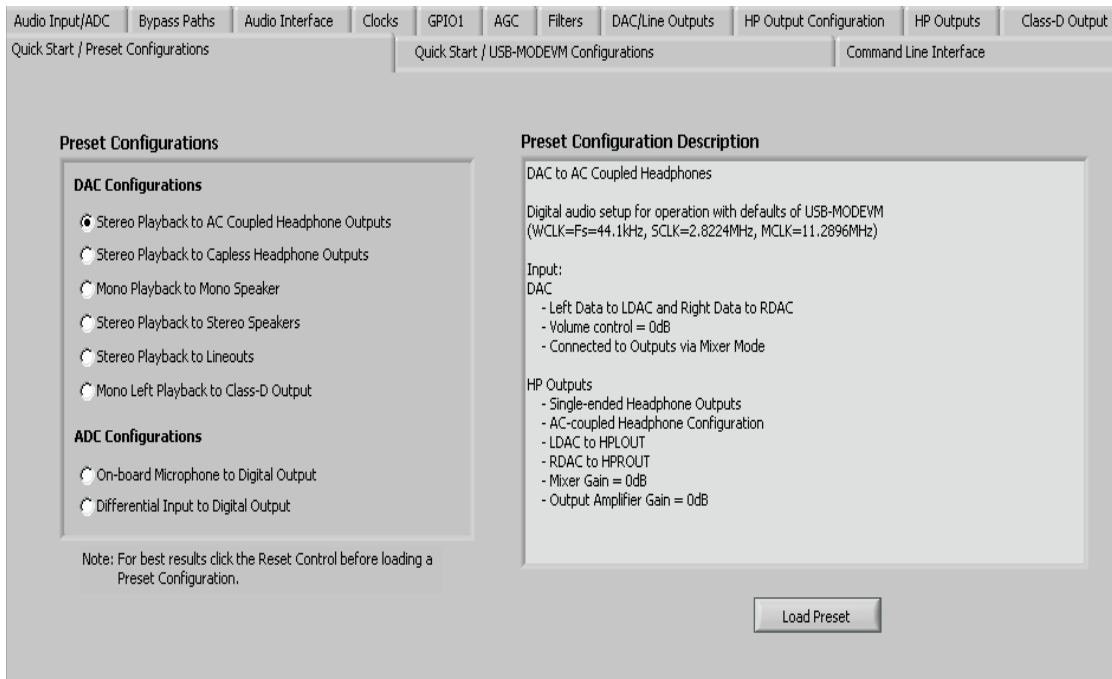
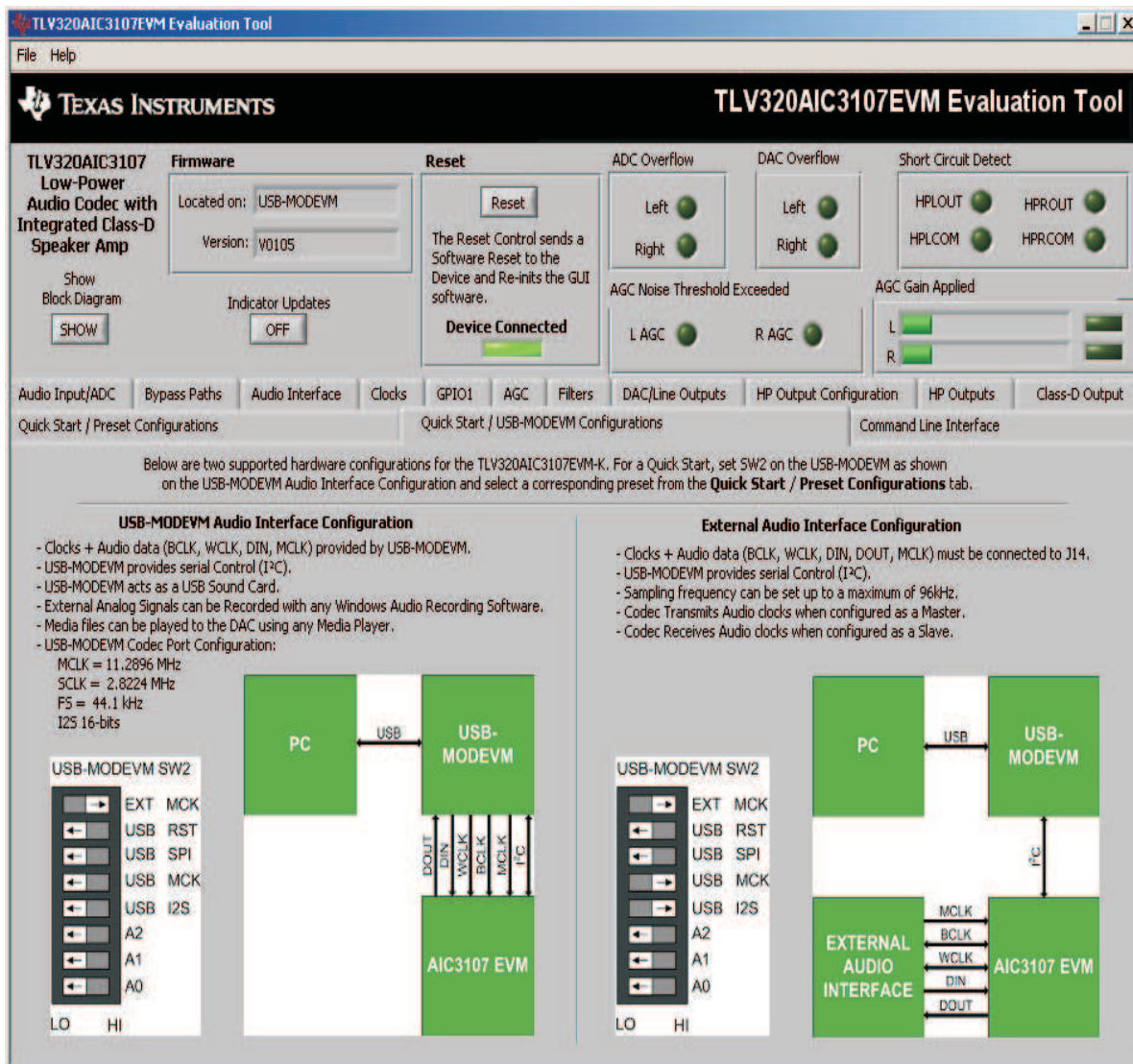

Figure 3. Quick Start - Preset Configurations Tab

The Quick Start Preset Configurations tab provides several different preset configurations of the codec (Figure 3). The **Preset Configurations** buttons allow the user to choose from the provided defaults. When the selection is made, the **Preset Configuration Description** shows a summary of the codec setup associated with the choice made. If the choice is acceptable, the **Load** button can be pressed, and the preset configuration is loaded into the codec. The user can change to the **Command Line Interface** tab (see Figure 30) to view the actual settings that were programmed into the codec. Note that the controls of the GUI are updated per any downloaded script whether it be a Preset Configuration script or a User Script run from the Command Line Interface tab.

## 4.2 Main Software Screen With Indicators and Functions



**Figure 4. Main Software Screen**

Figure 4 illustrates the main screen of the EVM software. The indicators and buttons located above the tabbed section of the front page are visible regardless of which tab is currently being selected.

The firmware box indicates from where the firmware being used is operating. In this release, the firmware is on the USB-MODEVM, so the user sees *USB-MODEVM* in the box labeled **Located on:**. The version of the firmware appears in the **Version** box below this.

To the right, the next group box contains controls for resetting the TLV320AIC3107EVM. A software reset can be done by writing to a register in the TLV320AIC3107EVM; this is accomplished by clicking the button labeled **Reset**.

Near the **Firmware** box, the **Device Connected** LED is green when the EVM is wcnkled. If the indicator is red, the EVM is not properly connected to the PC. Disconnect the EVM, and verify that the drivers were correctly installed. Then reconnect, and try restarting the software.

On the upper right portion of the screen are located several indicators which provide the status of various portions of the TLV320AIC3107. Pressing the **Indicator Updates** button activates these indicators. These indicators, as well as the other indicators on this panel, are updated only when the software's front panel is inactive, once every 20 ms.

The **ADC Overflow** and **DAC Overflow** indicators illuminate when the overflow flags are set in the TLV320AIC3107. Below these indicators are the **AGC Noise Threshold Exceeded** indicators that illuminate when the AGC noise threshold is exceeded. To the far right of the screen, the **Short Circuit Detect** indicators illuminate when a short-circuit condition is detected, if this feature has been enabled. Below the short-circuit indicators, the **AGC Gain Applied** indicators use a bar graph to show the amount of gain which has been applied by the AGC and indicators that illuminate when the AGC is saturated.

#### 4.2.1 Detailed TLV320AIC3107 Block Diagram

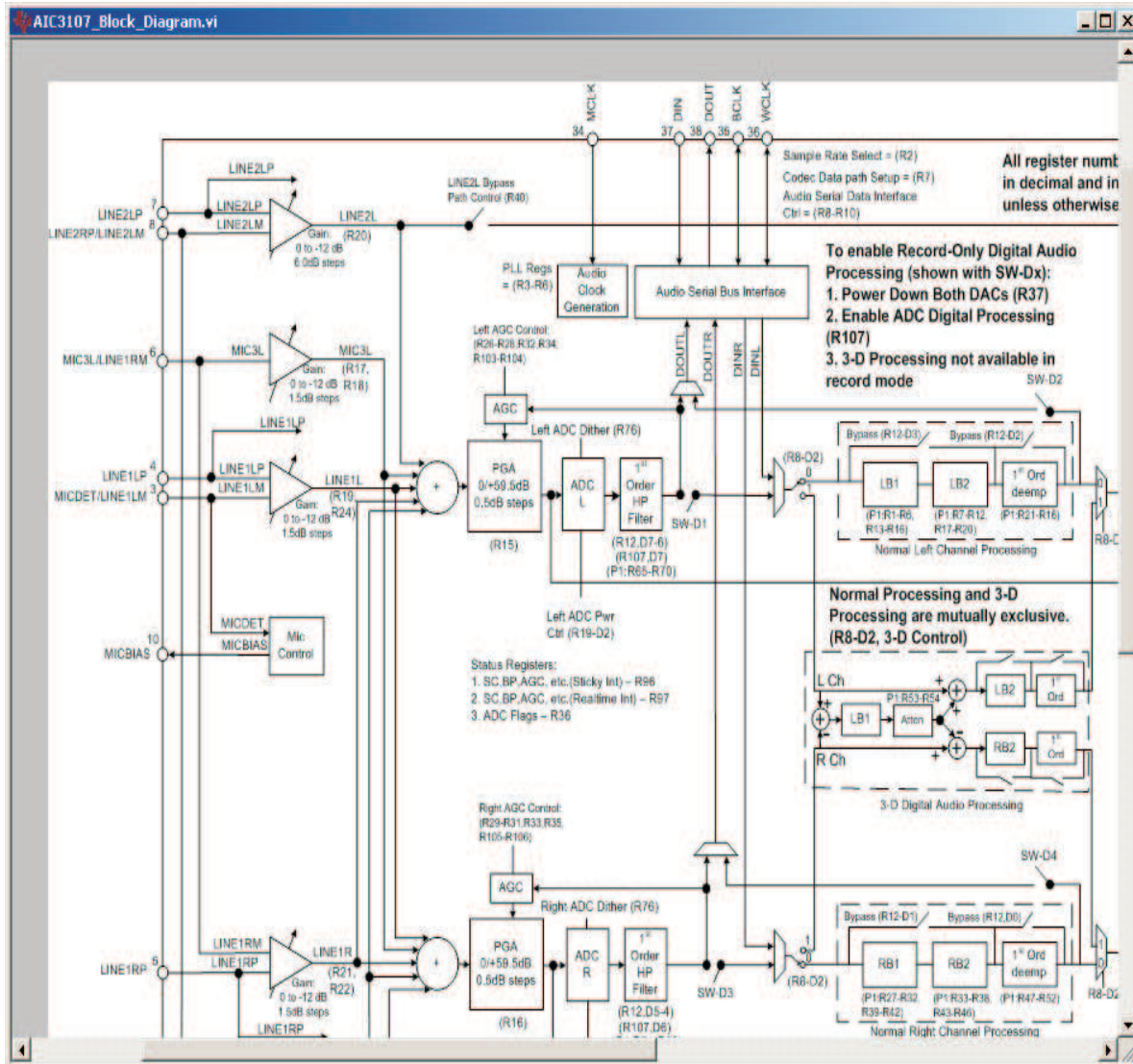
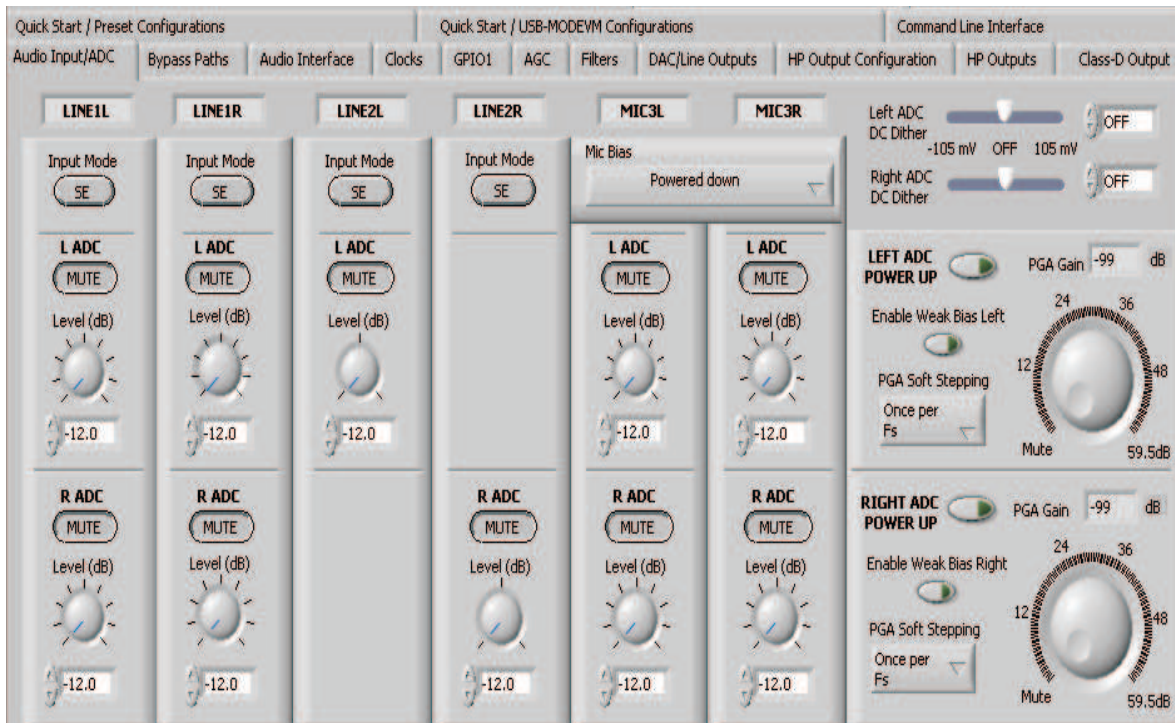

Figure 5.

To view the detailed block diagram, click on the "Show" button at the top left of the Main Software Screen (Figure 4). This block diagram shows the details of the processing blocks of the TLV320AIC3107 including the I<sup>2</sup>C registers associated with each block.

### 4.3 Audio Input/ADC Tab



**Figure 6. Audio Input/ADC Tab**

The **Audio Input/ADC** tab allows control of the analog input mixer and the ADC. The controls are displayed to look similar to an audio mixing console (see [Figure 6](#)). Each analog input channel has a vertical strip that corresponds to that channel. By default, all inputs are muted when the TLV320AIC3107 is powered up.

To route an analog input to the ADC:

1. Select the **Input Mode** button to correctly show if the input signal is single-ended (*SE*) or fully-differential (*Diff*). Inputs that are single-ended must be made to the positive signal terminal.
2. Click on the button of the analog input channel that corresponds to the correct ADC. The caption of the button changes to *Active*. Note that the user can connect some channels to both ADCs, whereas others only connect to one ADC.
3. Adjust the **Level** control to the desired attenuation for the connected channel. This level adjustment can be done independently for each connection.

The TLV320AIC3107 offers a programmable microphone bias that can either be powered down, set to 2 V, 2.5 V, or the power supply voltage of the ADC (AVDD\_ADC). Control of the microphone bias (mic bias) voltage is accomplished by using the **Mic Bias** pulldown menu button above the last two channel strips. To use the onboard microphone, hardware jumpers W10 and W11 must be installed. Nothing must be plugged into J9, in order for the mic bias settings in the software to take effect. Also, jumper W9 (Mic Bias Sel) must be set to connect positions 2 and 3, so that MICBIAS is controlled by the TLV320AIC3107.

Also shown are controls for **Weak Common Mode Bias**. Enabling these controls results in unselected inputs to the ADC channels to be weakly biased to the ADC common mode voltage.

Nearby are the controls for the ADC PGA, including the master volume controls for the ADC inputs. Each channel of the ADC can be powered up or down as needed using the **Power Up** buttons. PGA soft-stepping for each channel is selected using the pulldown menu control. The two large knobs set the actual **ADC PGA Gain** and allow adjustment of the PGA gains from 0 dB to 59.5 dB in 0.5-dB steps (excluding Mute). At the extreme counterclockwise rotation, the channel is muted. Rotating the knob clockwise increases the PGA gain, which is displayed in the box directly above the volume control.

## 4.4 Bypass Paths Tab

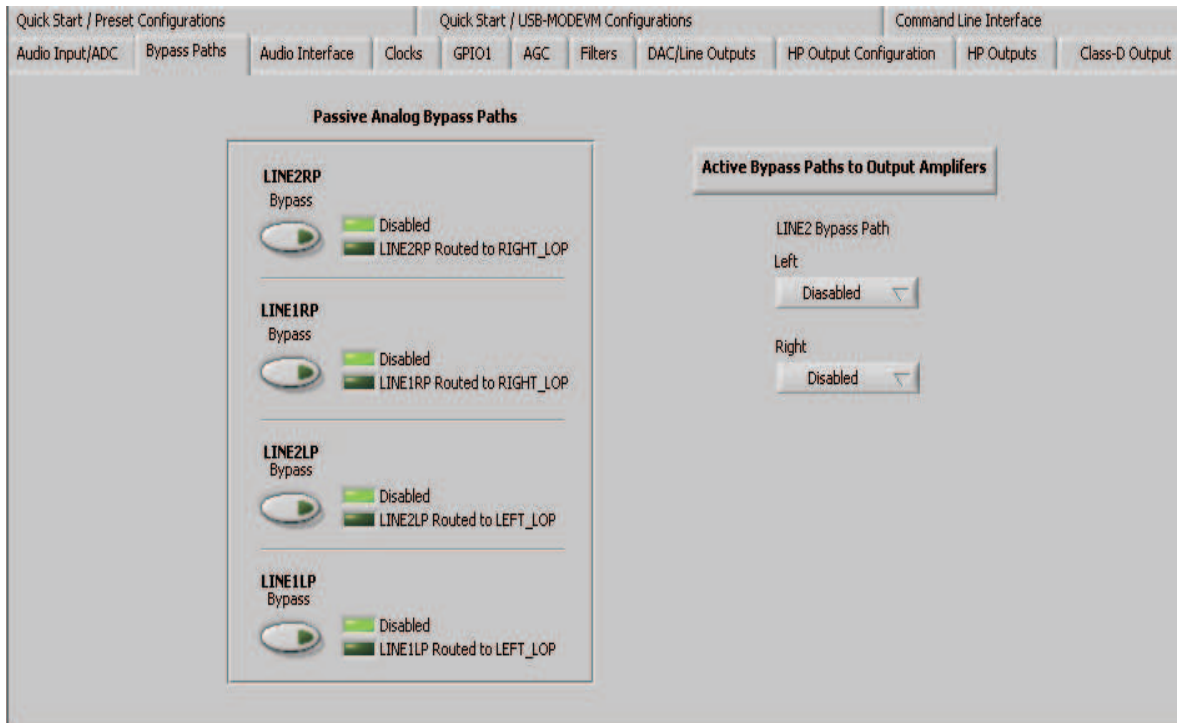
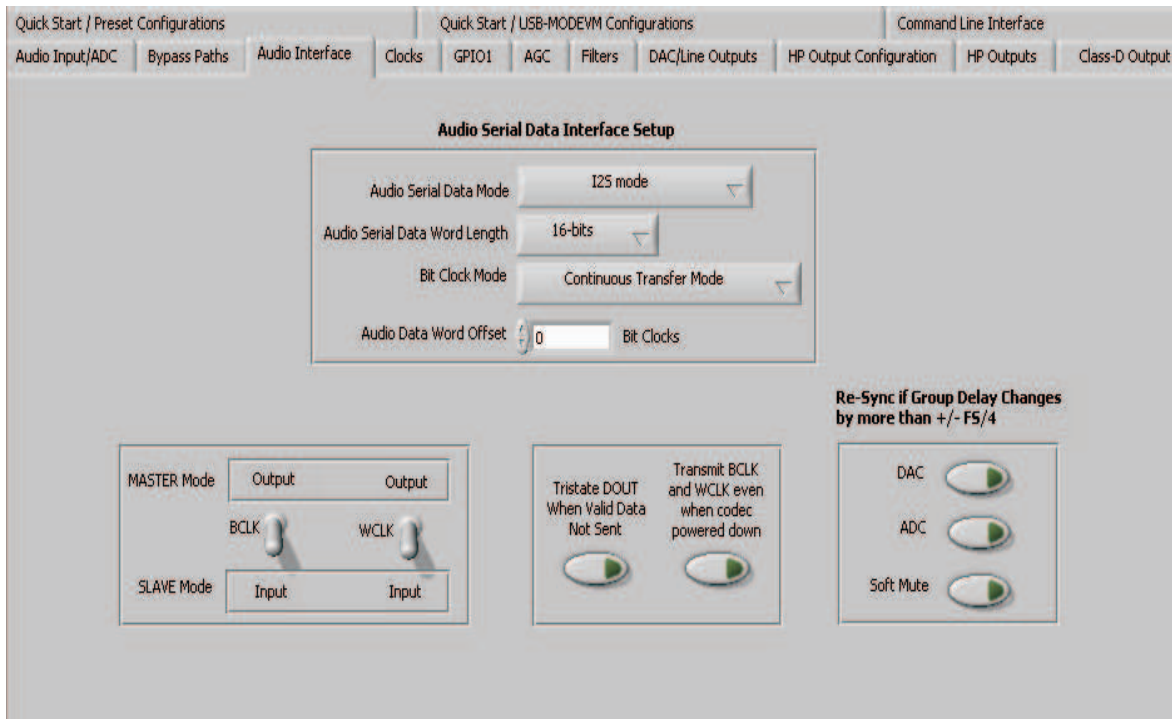

Figure 7. Bypass Paths Tab

As shown in [Figure 7](#), several analog bypass paths are available in the TMS320AIC3107. LINE1RP, LINE2RP, LINE1LP, and LINE2LP inputs can be passively bypassed to either RIGHT\_LOP or LEFT\_LOP by using the **Passive Analog Bypass Paths** controls. LINE2L (left) and LINE2R (right) buffered inputs can be directed to the output mixer sections by using the **Active Bypass Paths to Output Amplifiers** controls.

## 4.5 Audio Interface Tab



**Figure 8. Audio Interface Tab**

The Audio Interface tab (Figure 8) allows configuration of the audio digital data interface to the TLV320AIC3107.

The interface mode can be selected using the **Audio Serial Data Mode** control—selecting either I<sup>2</sup>S mode, DSP mode, or Right- or Left-Justified modes. Word length can be selected using the **Audio Serial Word Length** control, and the bit clock rate can also be selected using the **Bit Clock Mode** rate control. The **Audio Data Word Offset**, used in TDM mode (see the [product data sheet](#)) also can be selected on this tab.

Along the bottom of this tab are controls for choosing the **BCLK** and **WCLK** as being either inputs or outputs. With the codec configured in *Slave* mode, both the BCLK and WCLK are set to inputs. If the codec is in *Master* mode, then BCLK and WCLK are configured as outputs. Additionally, two buttons provide the options for 3-stating the DOUT line when no valid data is available and for transmitting BCLK and WCLK when the codec is powered down.

Re-synchronization of the audio bus is enabled using the controls in the lower right corner of this screen. Re-synchronization is done if the group delay changes by more than  $\pm FS/4$  for the ADC or DAC sample rates (see the [TLV320AIC3107](#) data sheet). The channels can be soft-muted when doing the Re-synchronization if the **Soft Mute** button is enabled.

The default mode for the EVM is configured as 44.1-kHz, 16-bit, I<sup>2</sup>C words, and the codec is a slave (BCLK and WCLK are supplied to the codec externally). For use with the PC software and the USB-MODEVM, the default settings must be used; no changes to the software are required.

## 4.6 Clocks Tab

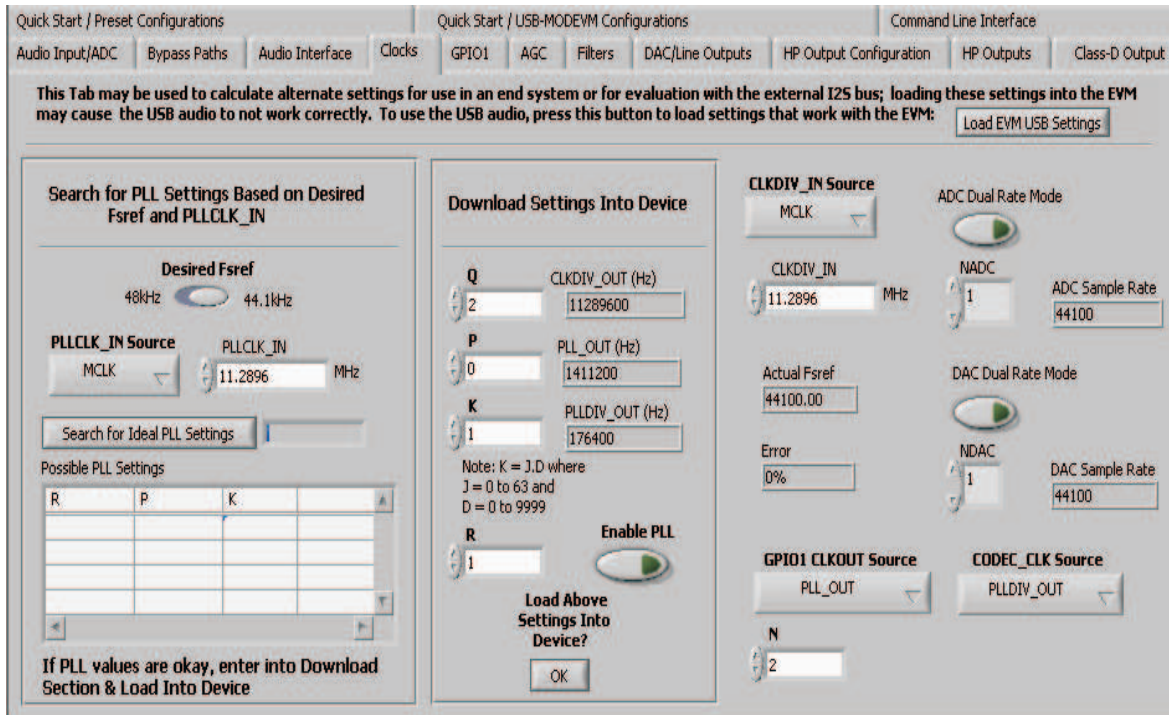

Figure 9. Clocks Tab

The TLV320AIC3107 provides a phase-locked loop (PLL) that allows flexibility in the clock generation for the ADC and DAC sample rates. The Clocks tab contains the controls that can be used to configure the TLV320AIC3107 for operation with a wide range of master clocks. See the Audio Clock Generation Processing figure in the [TLV320AIC3107](#) data sheet for further details of selecting the correct clock settings.

For use with the PC software and the USB-MODEVM, the clock settings must be set a certain way. If the settings are changed from the default settings which allow operation from the USB-MODEVM clock reference, the EVM settings can be restored automatically by clicking the **Load EVM USB Settings** button. Note that changing any of the clock settings from the values loaded when this button is pushed can result in the EVM not working properly with the PC software or USB interface. If an external audio bus is used (audio not driven over the USB bus), then settings can be changed to any valid combination. See [Figure 9](#).

### 4.6.1 Configuring the Codec Clocks and Fsref Calculation

The codec clock source is chosen by the **CODEC\_CLK Source** control. When this control is set to *CLKDIV\_OUT*, the PLL is not used; when set to *PLLDIV\_OUT*, the PLL is used to generate the clocks.

---

**Note:** Per the [TLV320AIC3107](#) data sheet, the codec must be configured to allow the value of Fsref to fall between the values of 39 kHz to 53 kHz.

---

#### 4.6.1.1 Use Without PLL

Setting up the TLV320AIC3107 for clocking without using the PLL permits the lowest power consumption by the codec. The **CLKDIV\_IN** source can be selected as either *MCLK* (default) or *BCLK*. The **CLKDIV\_IN** frequency then is entered into the **CLKDIV\_IN** box, in megahertz (MHz). The default value shown, 11.2896 MHz, is the frequency used on the USB-MODEVM board. This value then is divided by the value of **Q**, which can be set from 2 to 17; the resulting **CLKDIV\_OUT** frequency is shown in the indicator next to the **Q** control. The result frequency is shown as the *Actual Fsref*.

#### 4.6.1.2 Use With PLL

When **PLLDIV\_OUT** is selected as the codec clock source, the PLL is used. The PLL clock source is chosen using the **PLLCLK\_IN** control, and can be set to either *MCLK* or *BCLK*. The **PLLCLK\_IN** frequency then is entered into the **PLLCLK\_IN Source** box.

The **PLL\_OUT** and **PLLDIV\_OUT** indicators show the resulting PLL output frequencies with the values set for the **P**, **K**, and **R** parameters of the PLL. See the [TLV320AIC3107](#) data sheet for an explanation of these parameters. The parameters can be set by clicking on the up/down arrows of the **P**, **K**, and **R** combination boxes, or they can be typed into these boxes.

Use the **Search for PLL Settings Based on Desired Fsref and PLLCLK\_IN** section to find the ideal values of **P**, **K**, and **R** for a given PLL input frequency and desired **Fsref**:

1. Set the desired **Fsref** using the **Fsref** switch.
2. Verify that the correct reference frequency is entered into the **PLLCLK\_IN Source** box in megahertz (MHz)
3. Push the **Search for Ideal PLL Settings** button. The software starts searching for ideal combinations of **P**, **K**, and **R**, which achieve the desired **Fsref**. The possible settings for these parameters are displayed in the spreadsheet-like table labeled *Possible Settings*.
4. Click on a row in this table to select the **P**, **K**, and **R** values located in that row. Notice that when this is done, the software updates the **P**, **K**, **R**, **PLL\_OUT** and **PLLDIV\_OUT** readings, as well as the *Actual Fsref* and *Error* displays. The values show the calculations based on the values that were selected. This process does not actually load the values into the TLV320AIC3107, however; it only updates the displays in the software. If more than one row exists, the user can choose the other rows to see which of the possible settings comes closest to the ideal settings.

When a suitable combination of **P**, **K**, and **R** has been chosen, pressing the **Load Settings into Device?** button downloads these values into the appropriate registers on the TLV320AIC3107.

#### 4.6.1.3 Setting ADC and DAC Sampling Rates

The **Fsref** frequency that determines either enabling or bypassing the PLL (see [Section 4.6.1.1](#) or [Section 4.6.1.2](#)) is used to determine the actual ADC and DAC sampling rates. By using the **NADC** and **NDAC** factors, the sampling rates are derived from the **Fsref**. If the dual-rate mode is desired, this option can be enabled for either the ADC or DAC by pressing the corresponding **Dual Rate Mode** button. The ADC and DAC sampling rates are shown in the box to the right of each control.



## 4.7 GPIO1 Tab

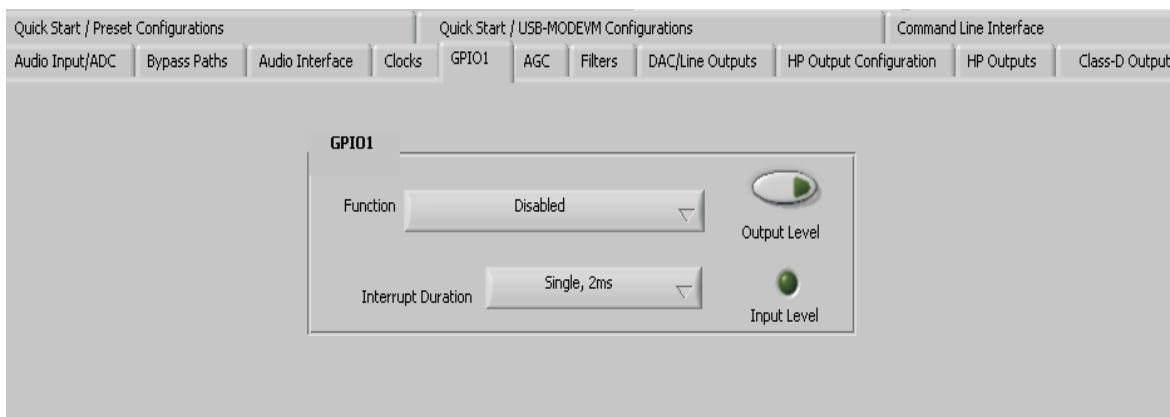

**Figure 10. GPIO1 Tab**

The GPIO1 tab (see [Figure 10](#)) selects options for the general-purpose inputs and outputs (GPIO) of the TLV320AIC3107.

The **GPIO1** groupbox contains controls for setting options for the GPIO1 pin. The **Function** control selects the function of GPIO1 from the following:

- ADC Word Clock
- An output clock derived from the reference clock (see [TLV320AIC3107](#) data sheet)
- Interrupt output pin to signal:
  - Short Circuit
  - AGC Noise Threshold detection
  - Jack/Headset detection
    - For use as an interrupt output, the behavior of the interrupt can be selected using the **Interrupt Duration** control. A *Single, 2ms* pulse can be delivered when the selected interrupt occurs, or *Continuous Pulses* can be generated signaling the interrupt.
- Alternate I<sup>2</sup>S Word Clock
- A general-purpose I/O pin
  - If selected as a *General Purpose Input*, the state of the GPIO1 pin is reflected by the **Input Level** indicator. If selected as a *General Purpose Output*, the state of the GPIO1 pin can be set by using the **Output Level** button.

## 4.8 AGC Tab

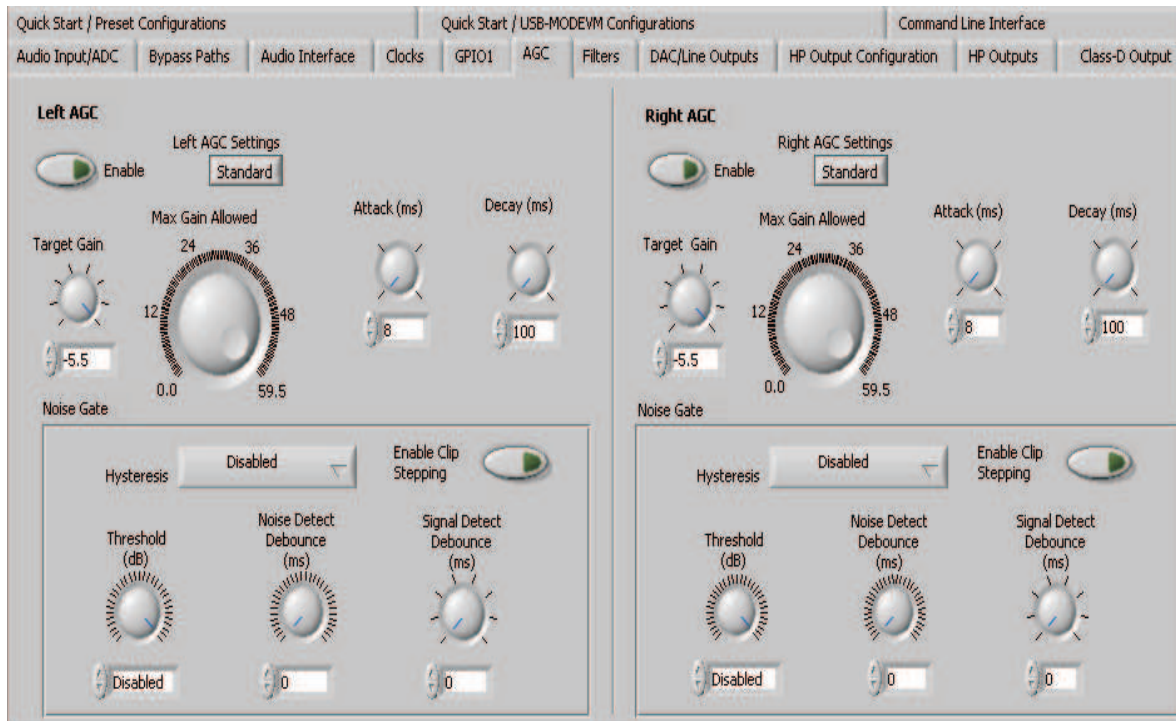
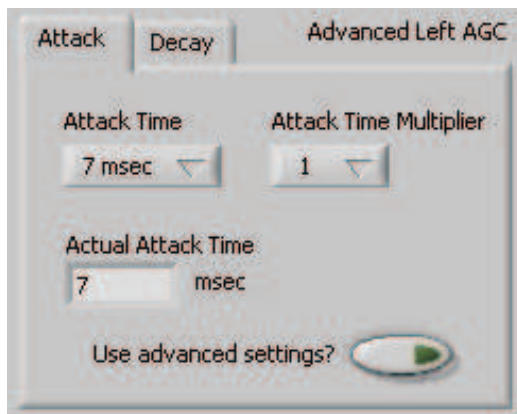

**Figure 11. AGC Tab**

The AGC tab (see [Figure 11](#)) consists of two identical sets of controls, one for the left channel and the other for the right channel. The AGC function is described in the [TLV320AIC3107](#) data sheet.

The AGC can be enabled for each channel using the **Enable AGC** button. **Target** gain, **Attack** time in milliseconds, **Decay** time in milliseconds, and the **Maximum PGA Gain Allowed** can all be set, respectively, using the four corresponding knobs in each channel.

The TLV320AIC3107 allows for the Attack and Decay times of the AGC to be setup in two different modes, standard and advanced. The **Left/Right AGC Settings** button determines the mode selection. The **Standard** mode provides several preset times that can be selected by adjustments made to the **Attack** and **Decay** knobs. If finer control over the times is required, then the **Advanced** mode is selected to change to the settings. When the **Advanced** mode is enabled, two tabs appear that allow separate, advanced control of the Attack and Delay times of the AGC (see [Figure 12](#) and [Figure 13](#)). These options allow selection of the base time as well as a multiplier to achieve the actual times shown in the corresponding text box. The **Use advanced settings?** button must be enabled to program the registers with the correct values selected via the pulldown options for base time and multiplier.



**Figure 12. Left AGC Settings**

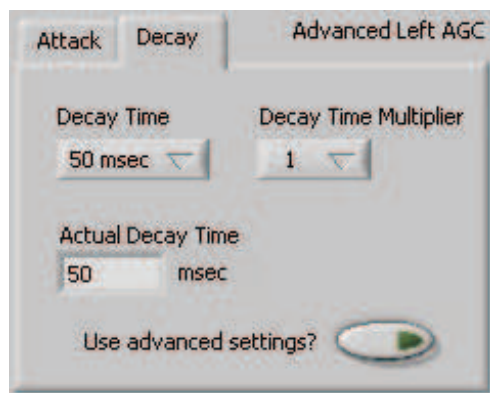

**Figure 13. Advanced**

Noise gate functions, such as **Hysteresis**, **Enable Clip stepping**, **Threshold (dB)**, **Signal Detect Debounce (ms)**, and **Noise Detect Debounce (ms)** are set using the corresponding controls in the **Noise Gate** groupbox for each channel.

## 4.9 Filters Tab

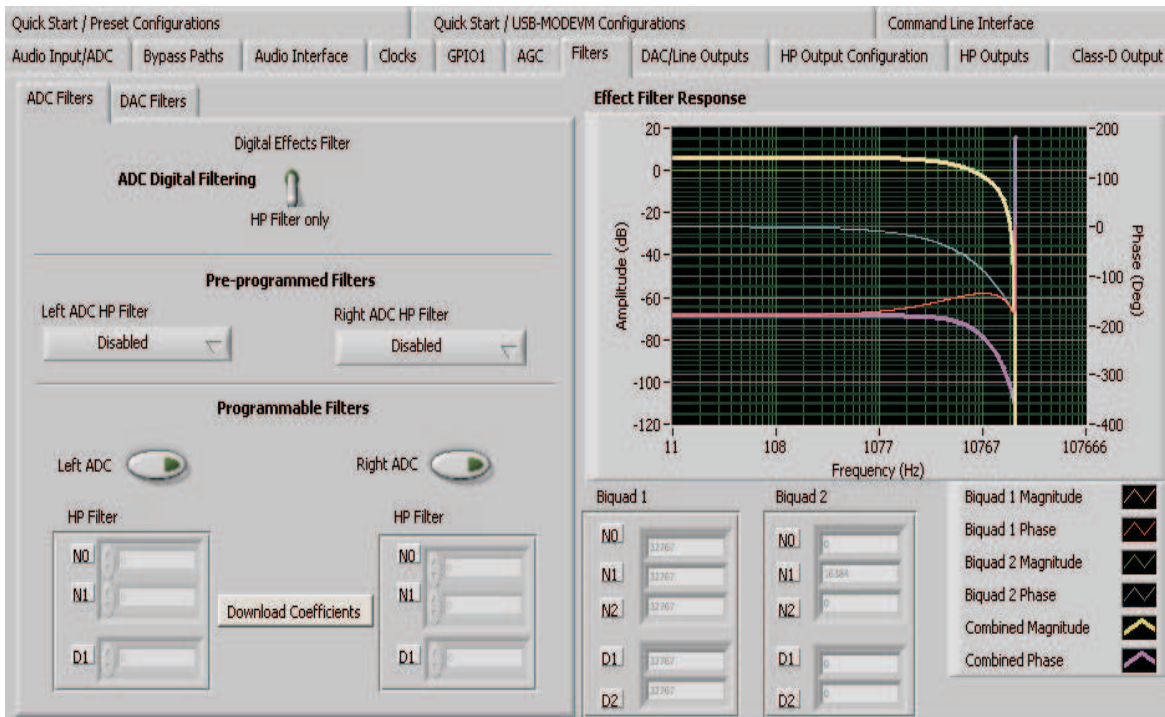

**Figure 14. Filters Tab**

The TLV320AIC3107 has an advanced feature set for applying digital filtering to audio signals. This tab controls all of the filter features of the TLV320AIC3107. In order to use this tab and have plotting of filter responses correct, the DAC sample rate must be set correctly. Therefore, the clocks must be set up correctly in the software following the discussion in [Section 4.6](#). See [Figure 14](#).

The AIC3107 digital filtering is available to both the ADC and DAC. The ADC has optional high-pass (HP) filtering and allows the digital output from the ADC through digital effects filtering before exiting the codec through the PCM interface. Likewise, the digital audio data can be routed through the digital effects filtering before passing through the optional de-emphasis filter before the DAC. The digital effects filtering can only be connected to either the ADC or DAC, not both at the same time.

The [Figure 14](#) is divided into several areas. The left side of the tab, is used to select between the DAC or ADC filters and to assist in the selection and calculating of the desired filter coefficients. The right side of the tab shows a frequency response plot of the digital effects filter selected and the coefficients that are programmed into the device. The plots show the magnitude and phase response of each biquad section, plus the combined responses of the two biquad filters. Note that the plot shows only the responses of the effect filters, not the combined response of those filter along with the de-emphasis and ADC high-pass filters.

## 4.9.1 ADC Filters

### 4.9.1.1 High-Pass Filter

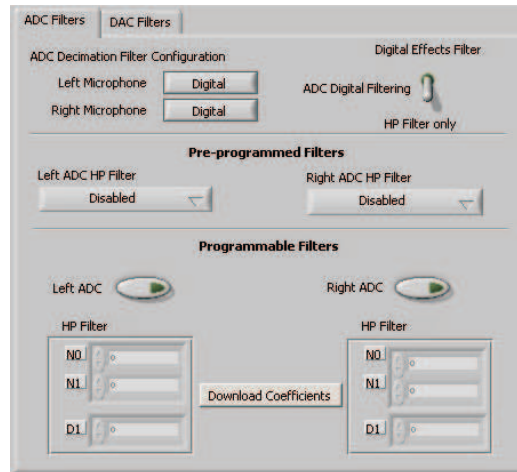

Figure 15. ADC High-Pass Filters

The TLV320AIC3107 ADC provides the option of enabling a high-pass filter, which helps to reduce the effects of DC offsets in the system. The [Figure 15](#) tab shows the options for programming various filter associated with the ADC. The high-pass filter has two modes: standard and programmable.

The standard high-pass filter option ([Figure 16](#)) allows for the selection of the high-pass filter frequency from several preset options that can be chosen with the **Left ADC HP Filter** and **Right ADC HP Filter** controls. The four options for this setting are disabled or three different corner frequencies which are based on the ADC sample rate.

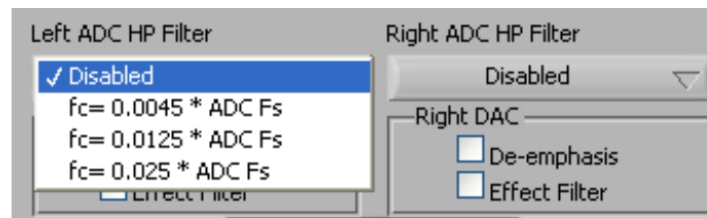

Figure 16. ADC High-Pass Filter Settings

For custom filter requirements, the programmable function allows custom coefficients to achieve a different filter than provided by the preset filters. The controls for the programmable high-pass filter are located under the **Programmable Filters** heading. The following steps describe the process:

1. Enter the filter coefficients in the **HP Filter** controls near the bottom of the tab.
2. Press the **Download Coefficients** button to download the coefficients to the codec registers.
3. Enable the Programmable High-Pass Filters by selecting the **Left ADC** and **Right ADC** buttons.

The programmable high-pass filter is now correctly programmed and enabled. The ADC can be enabled with the high-pass filter.

### 4.9.1.2 Digital Effects Filter - ADC

The ADC digital outputs stream can be routed through the digital effects filter in the codec to allow custom audio performance. The digital effects filter cannot operate on both the ADC or DAC at the same time. The digital effects filter operation is discussed in [Section 4.9.3](#)

## 4.9.2 DAC Filters

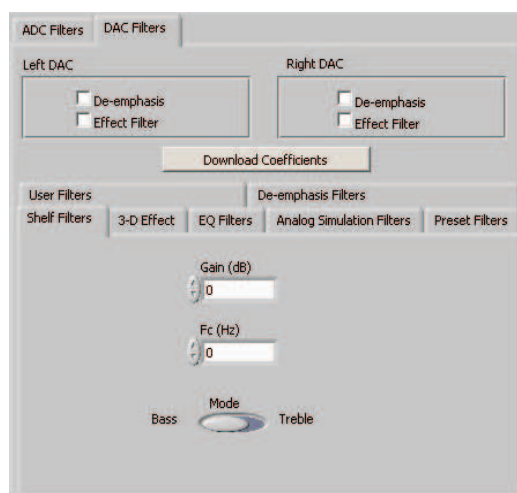

Figure 17. DAC Filters

### 4.9.2.1 De-emphasis Filters

The de-emphasis filters used in the TLV320AIC3107 can be programmed as described in the [TLV320AIC3107](#) data sheet, using this tab (Figure 18). Enter the coefficients for the de-emphasis filter response desired. While on this tab, the de-emphasis response is shown on the *Effect Filter Response* graph; however, note that this response is not included in graphs of other effect responses when on other filter design tabs.

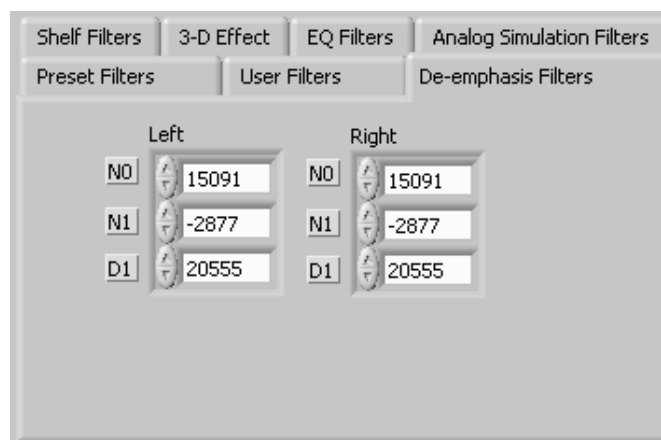

Figure 18. De-emphasis Filters

### 4.9.2.2 DAC Digital Effects Filter

The digital audio input stream can be routed through the digital effects filter in the codec before routing to the DAC to allow custom audio performance. The digital effects filter cannot operate on both the ADC or DAC at the same time. The digital effects filter operation is discussed in [Section 4.9.3](#)

### 4.9.3 Digital Effects Filters

The digital effect filters (the biquad filters) of the TLV320AIC3107 are selected using the check boxes shown in Figure 19. The de-emphasis filters are described in the [TLV320AIC3107](#) data sheet, and their coefficients can be changed (see Figure 17).



Figure 19. Enabling Filters

When designing filters for use with TLV320AIC3107, the software allows for several different filter types to be used. These options are shown on a tab control in the lower left corner of the screen. When a filter type is selected, and suitable input parameters defined, the response are shown in the *Effect Filter Response* graph. Regardless of the setting for enabling the Effect Filter, the filter coefficients are not loaded into the TLV320AIC3107 until the **Download Coefficients** button is pressed. To avoid noise during the update of coefficients, it is recommended that the user uncheck the **Effect Filter enable** check boxes before downloading coefficients. Once the desired coefficients are in the TLV320AIC3107, enable the Effect Filters by checking the boxes again.

#### 4.9.3.1 Shelf Filters

A shelf filter is a simple filter that applies a gain (positive or negative) to frequencies above or below a certain corner frequency. As shown in Figure 20, in *Bass* mode a shelf filter applies a gain to frequencies below the corner frequency; in *Treble* mode the gain is applied to frequencies above the corner frequency.

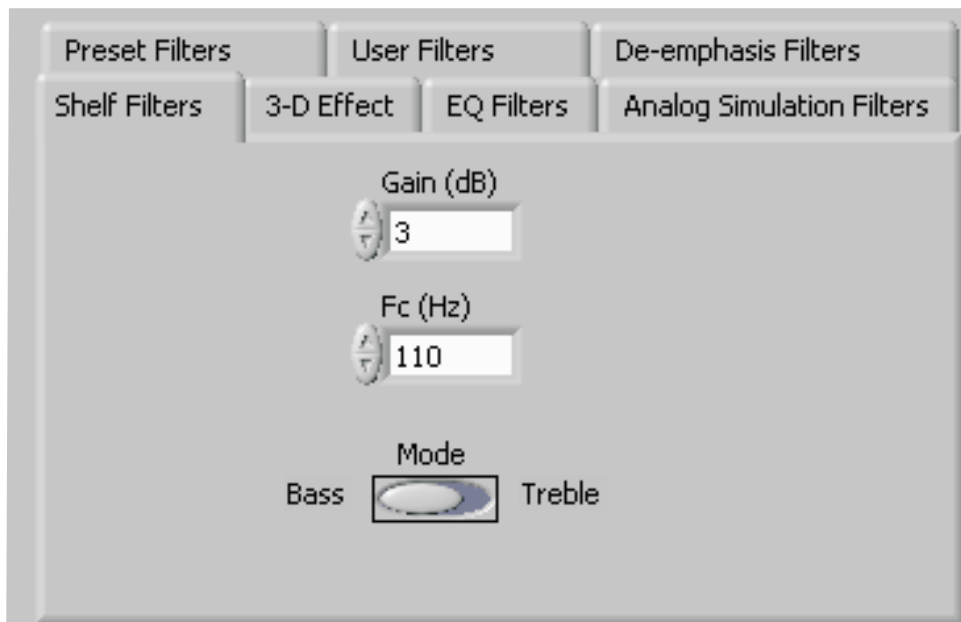
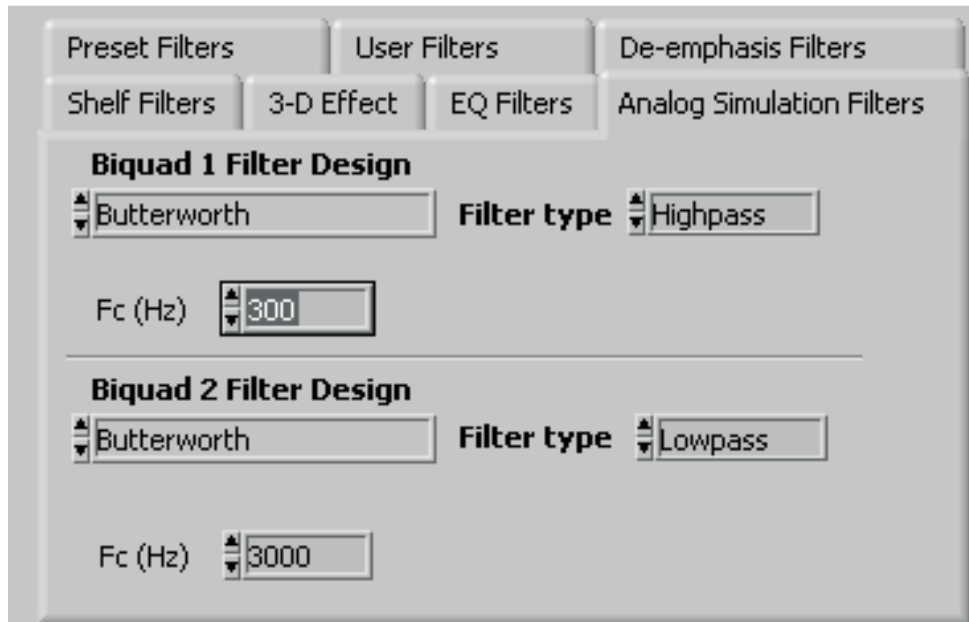

Figure 20. Shelf Filters

To use these filters, enter the gain desired and the corner frequency. Choose the mode to use (*Bass* or *Treble*); the response is plotted on the *Effect Filter Response* graph.

#### 4.9.3.2 EQ Filters

EQ, or parametric, filters can be designed on this tab (see [Figure 21](#)). Enter a gain, bandwidth, and a center frequency (Fc). Either bandpass (positive gain) or band-reject (negative gain) filters can be created



The screenshot shows a software interface with several tabs: 'Preset Filters', 'User Filters', 'De-emphasis Filters', 'Shelf Filters', '3-D Effect', 'EQ Filters', and 'Analog Simulation Filters'. The 'EQ Filters' tab is active. Below the tabs, there are two sections for filter design:

- Biquad 1 Filter Design:**
  - Filter type: Butterworth
  - Filter type: Highpass
  - Fc (Hz): 300
- Biquad 2 Filter Design:**
  - Filter type: Butterworth
  - Filter type: Lowpass
  - Fc (Hz): 3000

Figure 21. EQ Filters

#### 4.9.3.3 Analog Simulation Filters

Biquads are good at simulating analog filter designs. For each biquad section on this tab, enter the desired analog filter type to simulate (Butterworth, Chebyshev, Inverse Chebyshev, Elliptic, or Bessel). Parameter entry boxes appropriate to the filter type are shown (ripple, for example, with Chebyshev filters, etc.). Enter the desired design parameters, and the response is shown ( [Figure 22](#)).

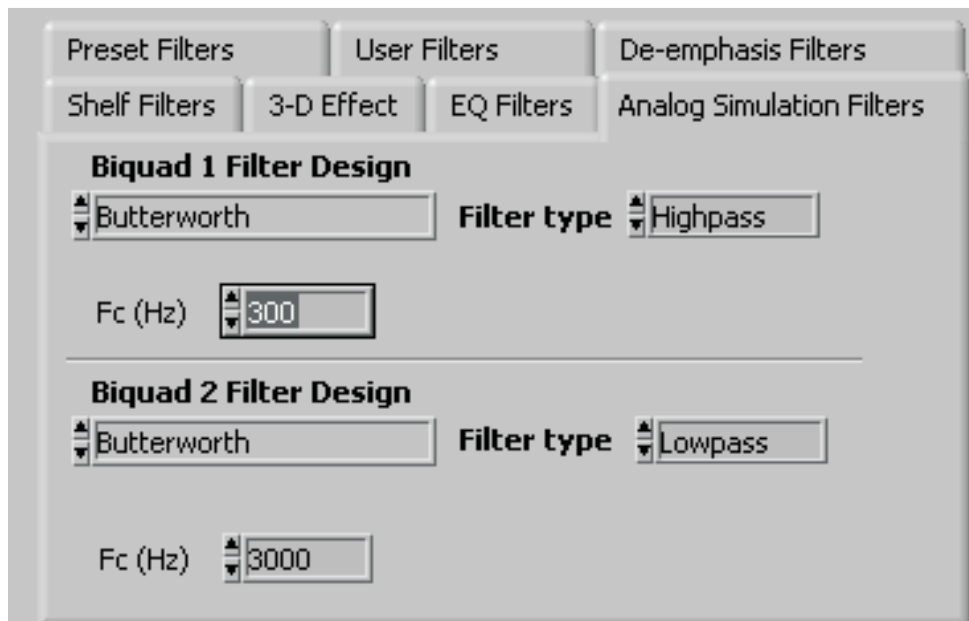

The screenshot shows a software interface with several tabs: 'Preset Filters', 'User Filters', 'De-emphasis Filters', 'Shelf Filters', '3-D Effect', 'EQ Filters', and 'Analog Simulation Filters'. The 'Analog Simulation Filters' tab is active. Below the tabs, there are two sections for filter design:

- Biquad 1 Filter Design:**
  - Filter type: Butterworth
  - Filter type: Highpass
  - Fc (Hz): 300
- Biquad 2 Filter Design:**
  - Filter type: Butterworth
  - Filter type: Lowpass
  - Fc (Hz): 3000

Figure 22. Analog Simulation Filters



#### 4.9.3.4 Preset Filters

Many applications are designed to provide preset filters common for certain types of program material. This tab (see [Figure 23](#)) allows selection of one of four preset filter responses - Rock, Jazz, Classical, or Pop.

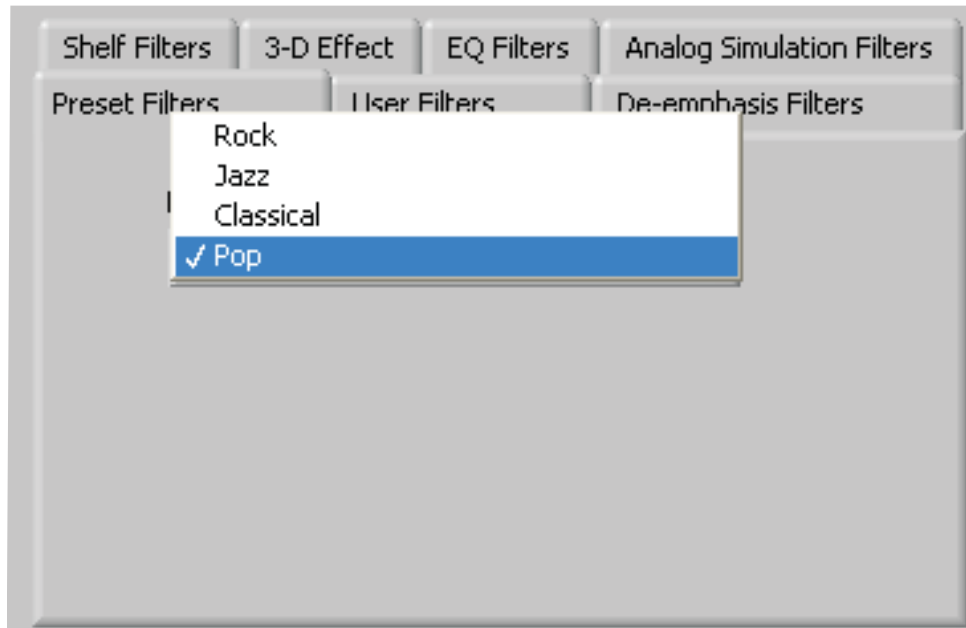

Figure 23. Preset Filters

#### 4.9.3.5 User Filters

If filter coefficients are known, they can be entered directly on this tab (see [Figure 24](#)) for both biquads for both left and right channels. The filter response is **not** shown on the *Effect Filter Response* graph for user filters.

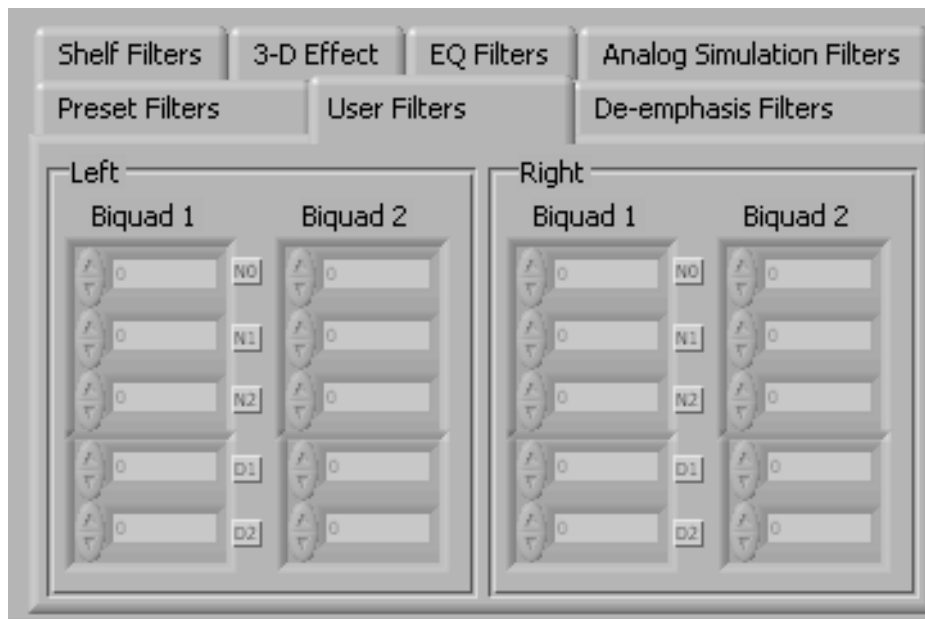
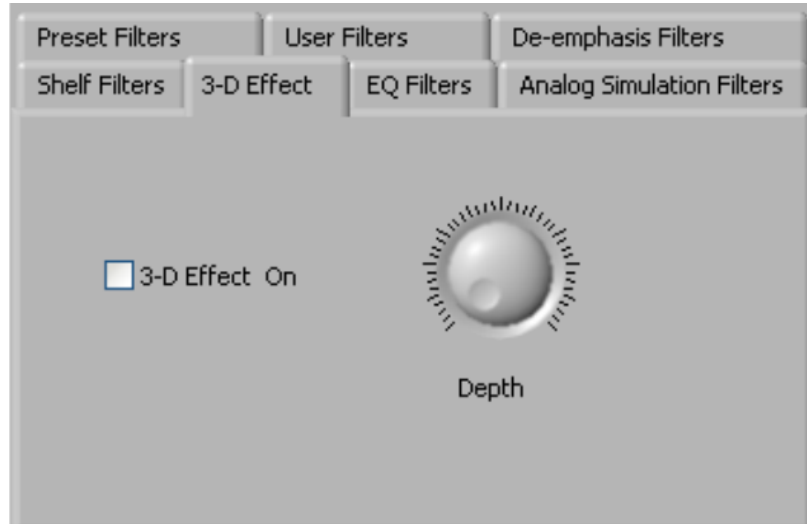

Figure 24. User Filters

#### 4.9.3.6 3D Effect

The 3D effect is described in the [TLV320AIC3107](#) data sheet. It uses the two biquad sections differently than most other effect filter settings. To use this effect properly, ensure that the appropriate coefficients are already loaded into the two biquad sections. The User Filters tab can be used to load the coefficients. See [Figure 25](#).



**Figure 25. 3D Effect Settings**

To enable the 3D effect, check the **3D Effect On** box. The **Depth** knob controls the value of the 3D Attenuation Coefficient.

#### 4.10 DAC/Line Outputs Tab

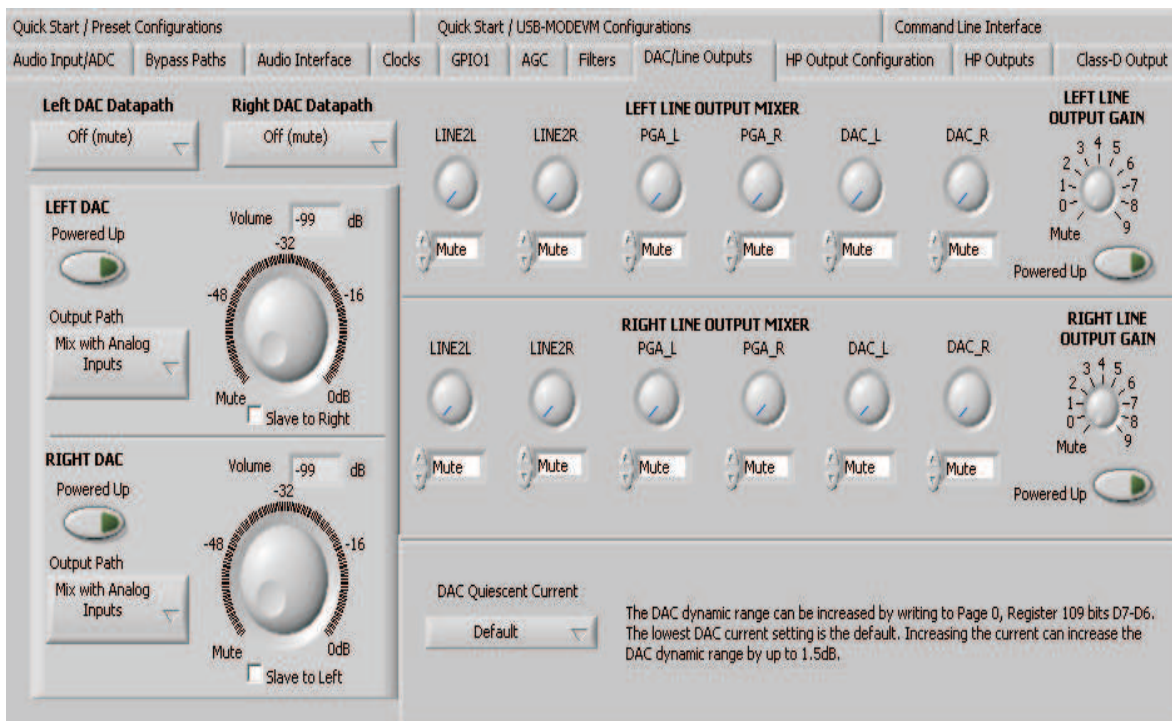

**Figure 26. DAC/Line Outputs Tab**

The DAC/Line Outputs tab controls the DAC power and volume, as well as routing of digital data to the DACs and the analog line output from the DACs. (See [Figure 26](#).)

#### 4.10.1 DAC Controls

On the left side of this tab are controls for the left and right DACs.

In similar fashion as the ADC, the DAC controls are set up to allow powering of each DAC individually and setting the output level. Each channel's level can be set independently using the corresponding **Volume** knob. Alternately, by checking the **Slave to Right** box, the left-channel Volume can be made to track the right-channel Volume knob setting; checking the **Slave to Left** box causes the right-channel Volume knob to track the left-channel Volume knob setting.

Data going to the DACs is selected using the drop-down boxes under the **Left** and **Right DAC Datapath**. Each DAC channel can be selected to be off, use left-channel data, use right-channel data, or use a mono mix of the left and right data.

Analog audio coming from the DACs is routed to outputs using the **Output Path** controls in each DAC control panel. The DAC output can be mixed with the analog inputs (LINE2L, LINE2R, PGA\_L, PGA\_R) and routed to the Line or High Power outputs using the mixer controls for these outputs on this tab (for the line outputs) or on the High Power Outputs tab (for the high power outputs). If the DAC is to be routed directly to either the Line or HP outputs, these can be selected as choices in the **Output Path** control. Note that if the Line or HP outputs are selected as the Output Path, the mixer controls on this tab and the High Power Output tabs have no effect.

#### 4.10.2 Line Output Mixers

On the right side of this tab are horizontal panels where the analog output mixing functions for the line outputs are located.

Each line output master volume is controlled by the knob at the far right of these panels, below the line output labels. The output amplifier gain can be muted or set at a value between 0 and 9 dB in 1-dB steps. Power/Enabled status for the line output can also be controlled using the button below this master output knob (**Powered Up**).

If the DAC **Output Path** control is set to *Mix with Analog Inputs*, the six knobs in each panel can be used to set the individual level of signals routed and mixed to the line output. LINE2L, LINE2R, PGA\_L, PGA\_R, and DAC\_L and DAC\_R levels can each be set to create a custom mix of signals presented to that particular line output. **Note:** if the DAC **Output Path** control is set to anything other than *Mix with Analog Inputs*, these controls have no effect.

## 4.11 HP Output Stage Configuration Tab

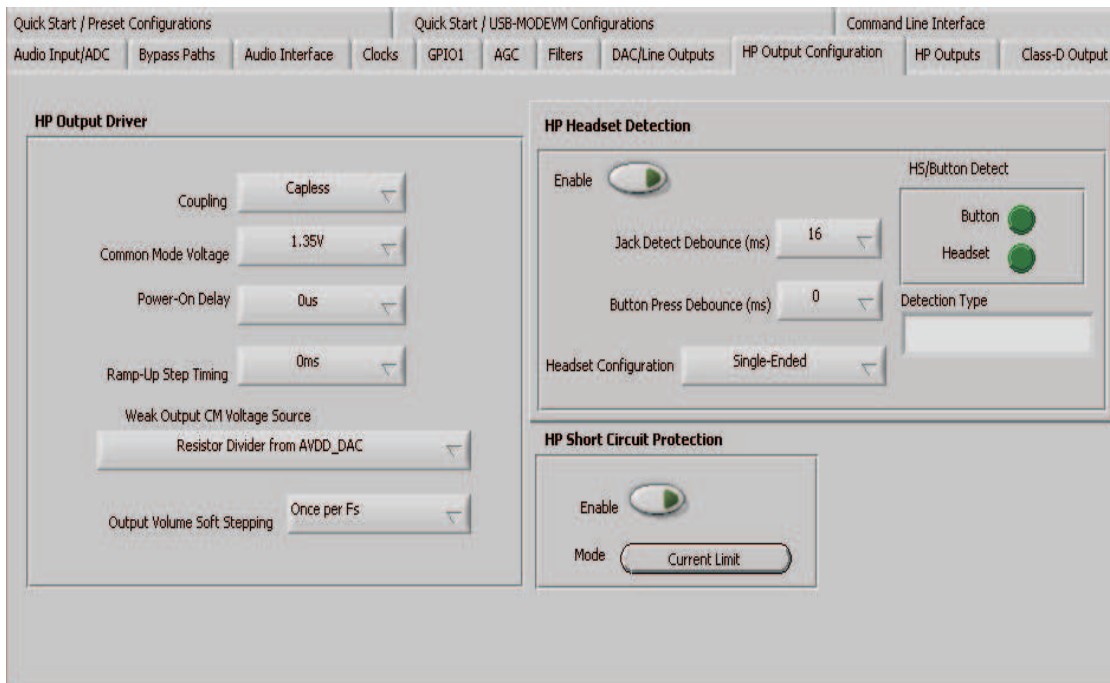

**Figure 27. Output Stage Configuration Tab**

The HP Output Stage Configuration tab (Figure 27) allows for setting various features of the output drivers.

The **Headset Configuration** control can be set as either *Fully-Differential* or *Pseudo-Differential*. This control is used to determine if the output stage is being used to drive a fully differential output load or a output load where one of the outputs is referenced to a common-mode voltage (pseudo-differential).

The output **Coupling** control can be chosen as either *Capless*, that is capacitor less, (EVM SW2-CAPLESS) or *AC-coupled* (EVM SW2-CAP). This setting corresponds to the setting of the hardware switch (SW2) on the TLV320AIC3107EVM.

The common-mode voltage of the outputs can be set to 1.35V, 1.5V, 1.65V, or 1.8V using the **Common Mode Voltage** control.

The TLV320AIC3107 offers several options to help reduce the turn-on/off pop of the output amplifiers. The **Power-On Delay** of the output drivers can be set using the corresponding control from 0  $\mu$ s up to 4  $\mu$ s. **Ramp-Up Step Timing** also can be adjusted from 0 ms to 4 ms. The outputs can be set to soft-step their volume changes, using the **Output Volume Soft Stepping** control, and set to step once per Fs period, once per two Fs periods, or soft-stepping can be disabled altogether.

The high power outputs of the TLV320AIC3107 can be configured to go to a weak common-mode voltage when powered down. The source of this weak common-mode voltage can be set on this tab with the **Weak Output CM Voltage Source** drop-down menu. Choices for the source are either a resistor divider off the AVDD\_DAC supply, or a bandgap reference. See the data sheet for more details on this option.

Headset detection features are enabled using the **Enable** button in the **HP Headset Detection** groupbox. When enabled, the indicators in the **HS/Button Detect** groupbox illuminate when either a button press or headset is detected. When a headset is detected, the type of headset is displayed in the **Detection Type** indicator. Debounce times for detection are set using the **Jack Detect Debounce** and **Button Press Debounce** controls, which offer debounce times in varying numbers of milliseconds. See the [TLV320AIC3107](#) data sheet for a discussion of headset detection.

Output short-circuit protection can be enabled in the **HP Short Circuit Protection** groupbox. Short Circuit Protection can use a current-limit mode, where the drivers limit current output if a short-circuit condition is detected, or in a mode where the drivers power down when such a condition exists.

## 4.12 HP Outputs Tab

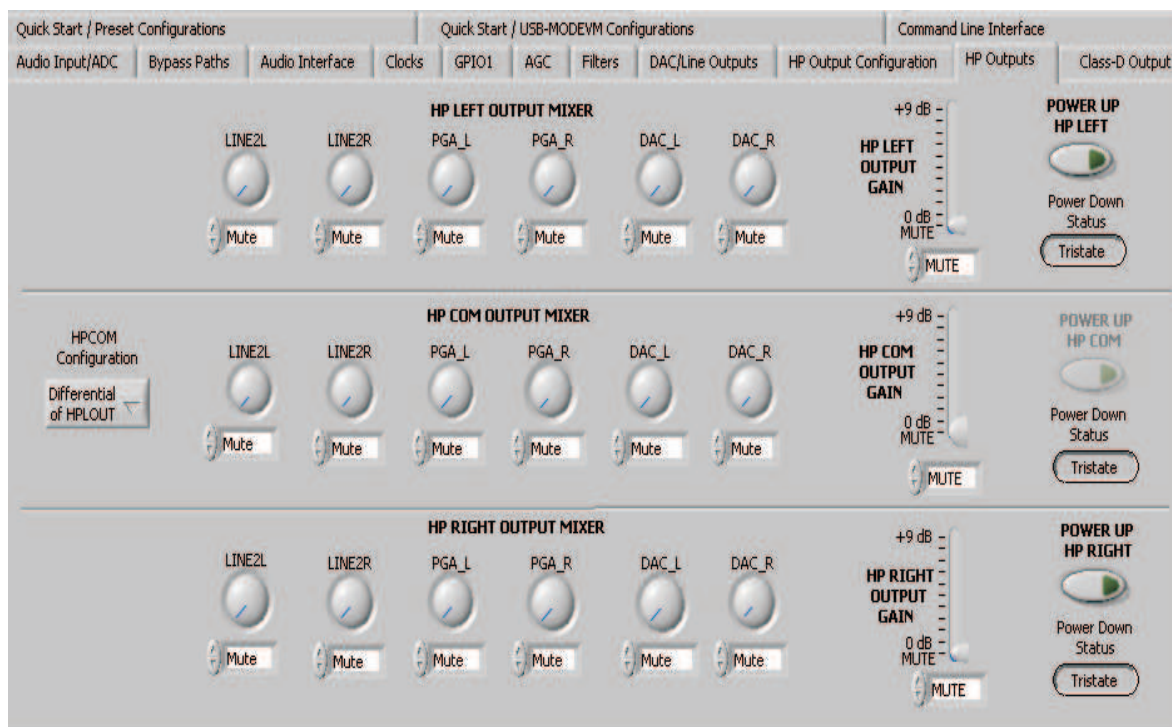

Figure 28. High Power Outputs Tab

This tab contains four horizontal groupings of controls, one for each of the high power outputs. Each output has a mixer to mix the LINE2L, LINE2R, PGA\_L, PGA\_R, DAC\_L and DAC\_R signals, assuming that the DACs are not routed directly to the high power outputs (see Section 4.10).

At the left of each output strip is a **Powered Up** button that controls whether the corresponding output is powered up or not. The **When powered down** button allows 3-state outputs or driven weakly to the output common-mode voltage.

The **HPxCOM** outputs (*HPLCOM* and *HPRCOM*) can be used as independent output channels or can be used as complementary signals to the *HPLOUT* and *HPROUT* outputs. In these complementary configurations, the **HPxCOM** outputs can be selected as *Differential of HPxOUT* signals to the corresponding outputs or can be set to be a common-mode voltage (*Constant VCM Out*). When used in these configurations, the **Powered Up** button for the **HPxCOM** output is disabled, as the power mode for that output tracks the power status of the HPL or HPR output that the COM output is tracking.

The **HPRCOM Config** selector allows a couple additional options compared to the **HPLCOM Config** selector. *Differential of HPLCOM* allows the HPRCOM to be the complementary signal of HPLCOM for driving a differential load between the **HPxCOM** outputs. The selector also allows *Ext. Feedback/HPLCOM constant VCM* as an option. This option is used when the high power outputs are configured for *Capless* output drive, where HPLCOM is configured as *Constant VCM Out*. The feedback option provides feedback to the output and lowers the output impedance of HPLCOM.

At the right side of the output strip is a master volume knob for that output, which allows the output amplifier gain to be muted or set from 0 to 9 dB in 1-dB steps.

### 4.13 Class-D Output Tab

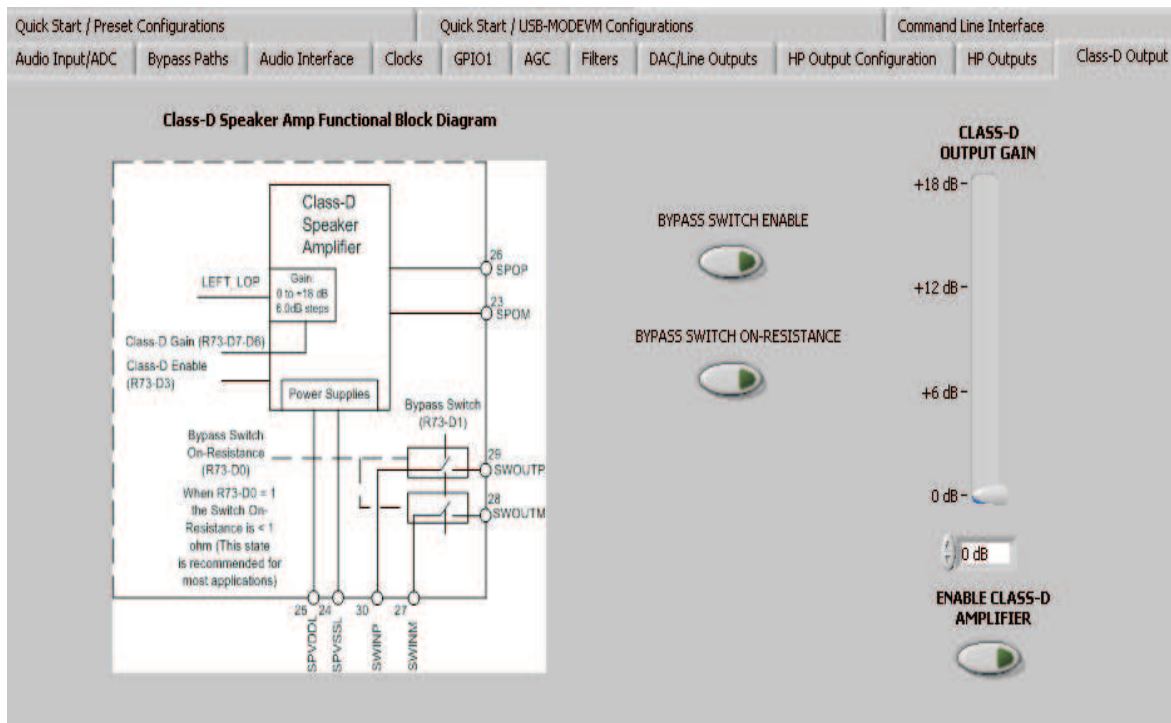

Figure 29. Class-D Output Tab

The integrated Class-D speaker amplifier can drive one watt into an 8-Ω load. Figure 29 shows the controls for the Class-D amplifier. The input to the Class-D amplifier is the same signal available at the left lineout LEFT\_LOP pin. The Class-D amplifier must be enabled first and then the gain control (0 dB to +18 dB) can be used. Note that many other gains are available in the signal path leading up to the Class-D amplifier.

Also available is the an analog bypass switch to allow a signal up to 3.3 V to be input at SWINP and SWINM and output at SWOUTP and SWOUTM. When the bypass switch is enabled (Register 76, D1), it is also recommended to enable the Bypass Switch Bootstrap Clock (Register 76, D0).

#### 4.14 Command Line Interface Tab

A simple scripting language controls the TAS1020 on the USB-MODEVM from the LabView™-based PC software. The main program controls, described previously, do nothing more than write a script which is then handed off to an interpreter that sends the appropriate data to the correct USB endpoint. Because this system is script based, provision is made in this tab for the user to view the scripting commands created as the controls are manipulated, as well as load and execute other scripts that have been written and saved (see Figure 30). This design allows the software to be used as a quick test tool or to help provide troubleshooting information in the rare event that the user encounters problem with this EVM.

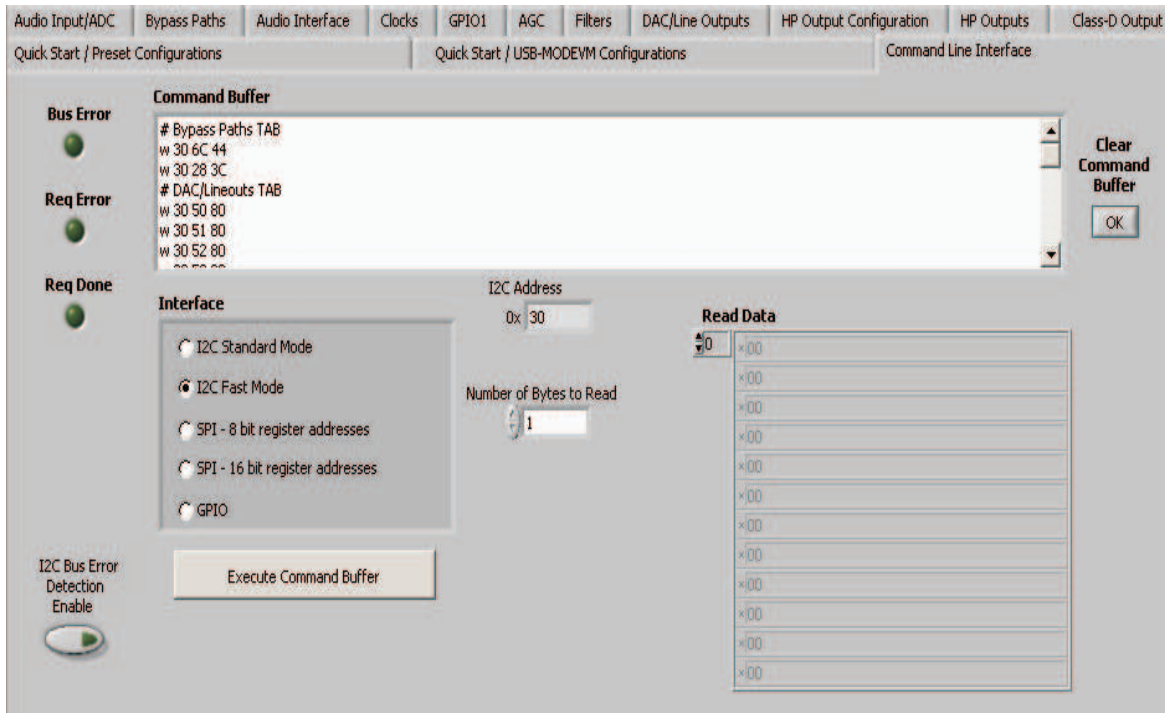

Figure 30. Command Line Interface Tab

A script is loaded into the command buffer, either by operating the controls on the other tabs or by loading a script file. When executed, the return packets of data which result from each command are displayed in the **Read Data** array control. When executing several commands, the Read Data control shows only the results of the last command. To see the results after every executed command, use the logging function described in the following text.

The File menu (Figure 31) provides some options for working with scripts. The first option, *Open Command File...*, loads a command file script into the command buffer. This script then can be executed by pressing the **Execute Command Buffer** button.

The second option is *Log Script and Results...*, which opens a file save dialog box. Choose a location for a log file to be written using this file save dialog. When the Execute Command Buffer button is pressed, the script runs, and the script along with resulting data read back during the script, is saved to the file specified. The log file is a standard text file that can be opened with any text editor and looks much like the source script file, but with the additional information of the result of each script command executed.

The third menu item is a submenu of *Recently Opened Files*. This is simply a list of script files that have previously been opened, allowing fast access to commonly used script files. The final menu item is *Exit*, which terminates the TLV320AIC3107EVM software.

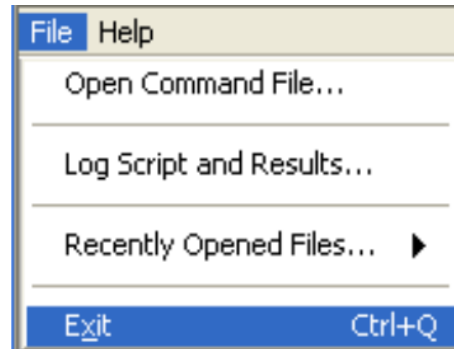

**Figure 31. File Menu**

Under the Help menu is an *About...* menu item which displays information about the TLV320AIC3107EVM software.

The **I<sup>2</sup>C Bus Error Detection** button allows the user to enable circuitry which sets a register bit (Register 107, D0) if an I<sup>2</sup>C bus error is detected. It is unnecessary to use this with the GUI software but can be used as part of error detection in the end-equipment software design.

The actual USB protocol used as well as instructions on writing scripts are detailed in the following subsections. Although it is unnecessary to understand or use either the protocol or the scripts directly, understanding them may be helpful to some users.



## Appendix A EVM Connector Descriptions

This appendix contains the connection details for each of the main header connectors on the EVM.

### A.1 Analog Interface Connectors

#### A.1.1 Analog Input/Output Connectors

In addition to the analog headers, the analog inputs and outputs also can be accessed through alternate connectors, either screw terminals or audio jacks. The stereo microphone input is also tied to J6 and the stereo headphone output (the HP set of outputs) is available at J7.

[Table A-1](#) summarizes the analog input/output connectors available for Block A.

**Table A-1. Analog Input/Output Connectors**

| Designator | Description                       | Function                                    | PIN 1                  | PIN 2               | PIN3                |
|------------|-----------------------------------|---|------------------------|---------------------|---------------------|
| J6         | 3-Conductor Screw Terminal Input  | See SW1 Configuration for SE/Diff Usage     | LINE1LP                | AGND                | LINE1LM             |
| J7         | 3-Conductor Screw Terminal Input  | See SW1 Configuration for SE/Diff Usage     | LINE1RP                | AGND                | LINE1RM             |
| J8         | 3-Conductor Screw Terminal Input  | See SW1 Configuration for SE/Diff Usage     | LINE2LP                | AGND                | LINE2LM             |
| J9         | Audio 3.5mm Stereo Input Jack     | External Mic Input (See SW1 Configuration)  | AGND                   | MIC3L               | MIC3R               |
| J10        | Audio 3.5mm Stereo Output Jack    | Headset Output (See SW2 Configuration)      | AGND                   | HPLOUT              | HPROUT              |
| J11        | Audio 3.5mm Stereo Output Jack    | Headset Test Output (See SW2 Configuration) | AGND                   | HPL-TEST (filtered) | HPR-TEST (filtered) |
| J12        | 3-Conductor Screw Terminal Output | Lineout                                     | LEFT_LOP               | AGND                | RIGHT_LOP           |
| J15        | 2-Conductor Screw Terminal Input  | External SVDD (Class-D Power)               | Class-D Voltage (SVDD) | SPGND (ground)      | NA                  |
| J16        | 2-Conductor Screw Terminal Input  | Switchable Analog Inputs                    | SWINM                  | SWINP               | NA                  |
| J17        | 2-Conductor Screw Terminal Output | Class-D Speaker Test                        | OUT-M (filtered)       | OUT-P (filtered)    | NA                  |
| J18        | 2-Conductor Screw Terminal Output | Class-D Speaker Output                      | SPOM                   | SPOP                | NA                  |

## A.2 Block A and Block B Digital Interface Connectors (J16 and J17)

The TLV320AIC3107EVM is designed to easily interface with multiple control platforms. Samtec part numbers SSW-110-22-F-D-VS-K and TSM-110-01-T-DV-P provide a convenient 10-pin dual row header/socket combination at J16 and J17. These headers/sockets provide access to the digital control and serial data pins of the device. Consult Samtec at [www.samtec.com](http://www.samtec.com) or call 1-800-SAMTEC-9 for a variety of mating connector options. Table A-2 summarizes the digital interface pinout for the TLV320AIC3107EVM.

**Table A-2. Block A and Block B Digital Interface Pinout**

| Pin Number | Signal      | Description                                     |
|------------|-------------|---|
| P4.1       | NC          | Not Connected                                   |
| P4.2       | NC          | Not Connected                                   |
| P4.3       | NC          | Not Connected                                   |
| P4.4       | DGND        | Digital Ground                                  |
| P4.5       | NC          | Not Connected                                   |
| P4.6       | GPIO1       | General Purpose Input/Output                    |
| P4.7       | NC          | Not Connected                                   |
| P4.8       | RESET INPUT | Reset signal input to AIC3107EVM                |
| P4.9       | NC          | Not Connected                                   |
| P4.10      | DGND        | Digital Ground                                  |
| P4.11      | NC          | Not Connected                                   |
| P4.12      | NC          | Not Connected                                   |
| P4.13      | NC          | Not Connected                                   |
| P4.14      | RESET       | Reset   |
| P4.15      | NC          | Not Connected                                   |
| P4.16      | NC          | Not Connected                                   |
| P4.17      | NC          | Not Connected                                   |
| P4.18      | DGND        | Digital Ground                                  |
| P4.19      | NC          | Not Connected                                   |
| P4.20      | NC          | Not Connected                                   |
| P5.1       | NC          | Not Connected                                   |
| P5.2       | NC          | Not Connected                                   |
| P5.3       | BCLK        | Audio Serial Data Bus Bit Clock (Input/Output)  |
| P5.4       | DGND        | Digital Ground                                  |
| P5.5       | NC          | Not Connected                                   |
| P5.6       | NC          | Not Connected                                   |
| P5.7       | WCLK        | Audio Serial Data Bus Word Clock (Input/Output) |
| P5.8       | NC          | Not Connected                                   |
| P5.9       | NC          | Not Connected                                   |
| P5.10      | DGND        | Digital Ground                                  |
| P5.11      | DIN         | Audio Serial Data Bus Data Input (Input)        |
| P5.12      | NC          | Not Connected                                   |
| P5.13      | DOUT        | Audio Serial Data Bus Data Output (Output)      |
| P5.14      | NC          | Not Connected                                   |
| P5.15      | NC          | Not Connected                                   |
| P5.16      | SCL         | I <sup>2</sup> C Serial Clock                   |
| P5.17      | MCLK        | Block A Master Clock Input                      |
| P5.18      | DGND        | Digital Ground                                  |
| P5.19      | NC          | Not Connected                                   |
| P5.20      | SDA         | I <sup>2</sup> C Serial Data Input/Output       |

Note that P5 comprises the signals needed for an I<sup>2</sup>S serial digital audio interface; the control interface (I<sup>2</sup>C and  $\overline{\text{RESET}}$ ) signals are routed to P4. I<sup>2</sup>C is actually routed to both connectors; however, the device is connected only to P4.

### A.3 Power Supply Connector Pin Header, J15

J15 provides connection to the common power bus for the TLV320AIC3107EVM. Power is supplied on the pins listed in [Table A-3](#).

**Table A-3. Power Supply Pinout**

| Signal       | Pin Number |        | Signal |
|--------------|------------|--------|--------|
| NC           | J15.1      | J15.2  | NC     |
| +5VA         | J15.3      | J15.4  | NC     |
| DGND         | J15.5      | J15.6  | AGND   |
| DVDD (1.8V)  | J15.7      | J15.8  | NC     |
| IOVDD (3.3V) | J15.9      | J15.10 | NC     |

The TLV320AIC3107EVM-K motherboard (the USB-MODEVM Interface board) supplies power to J15 of the TLV320AIC3107EVM. Power for the motherboard is supplied either through its USB connection or via terminal blocks on that board.

## Appendix B TLV320AIC3107EVM Schematic

The schematic diagram for the modular TLV320AIC3107EVM is provided as a reference.

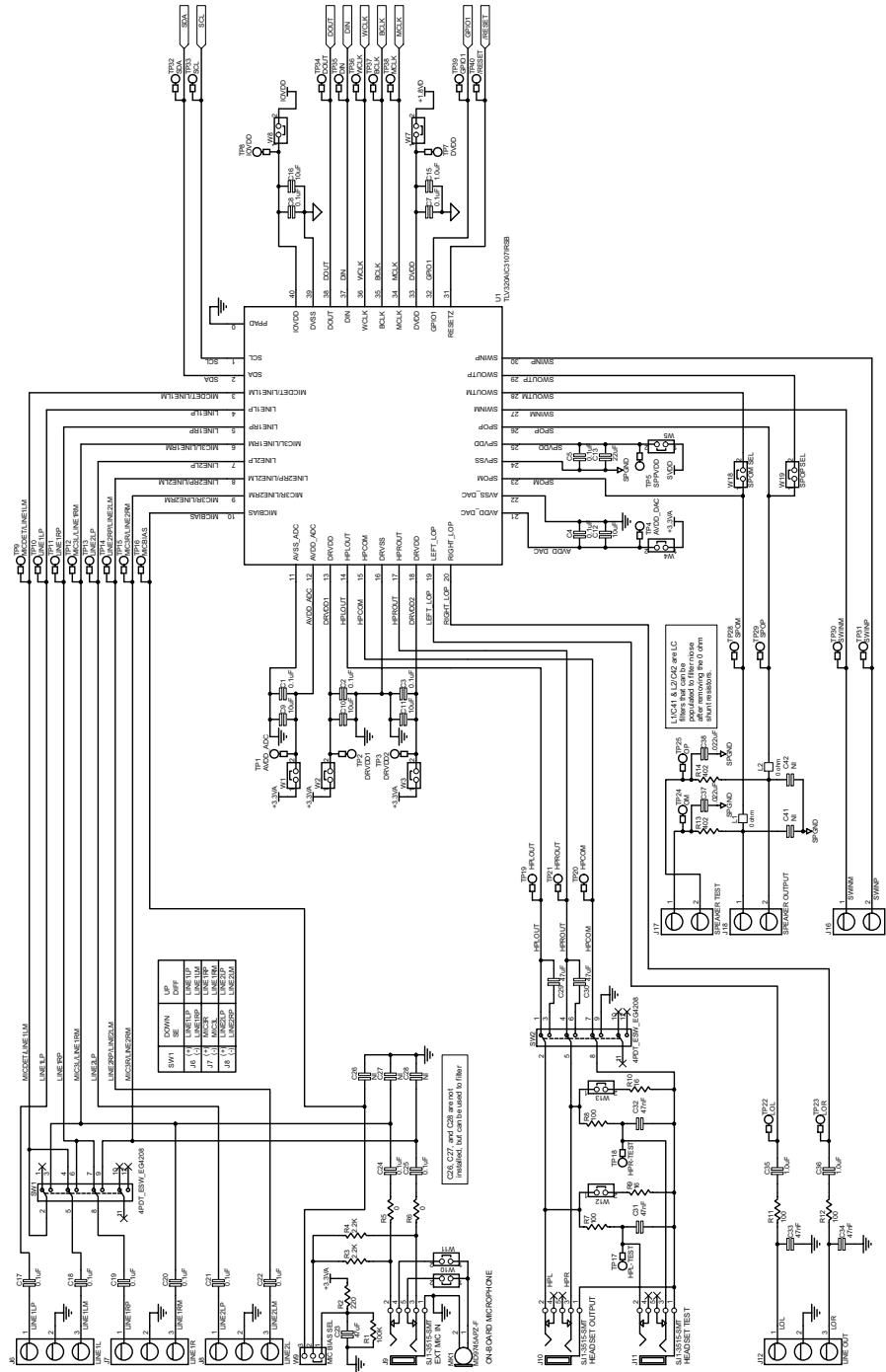

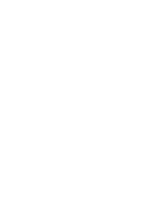
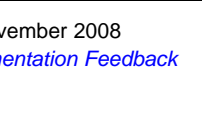
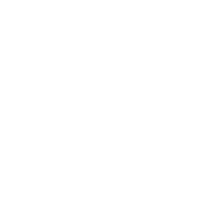
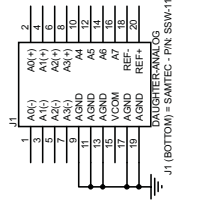
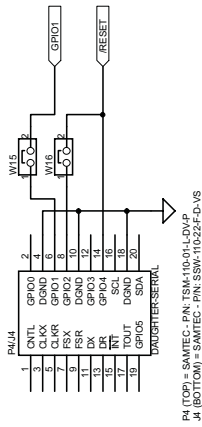

Appendix C TLV320AIC3107EVM Layout Views

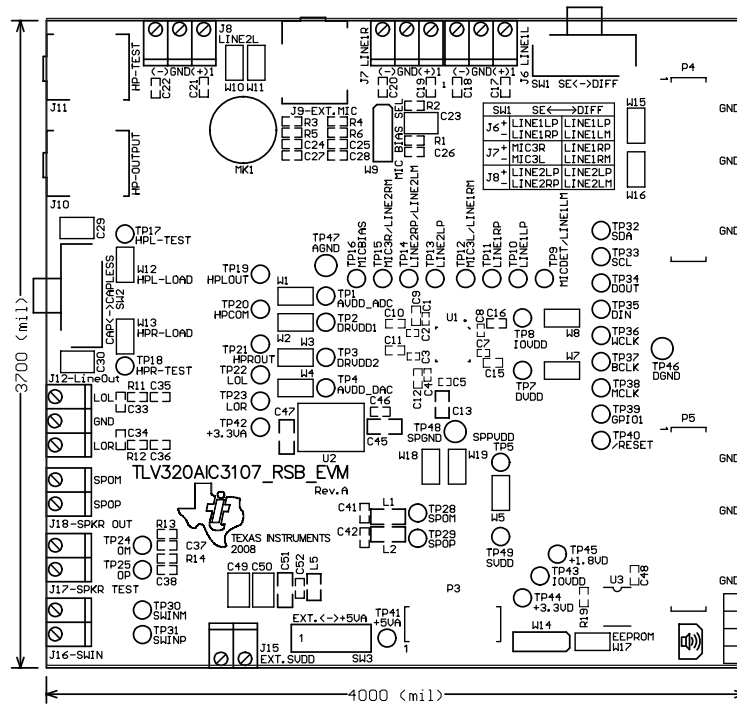

Figure C-1. Assembly layer

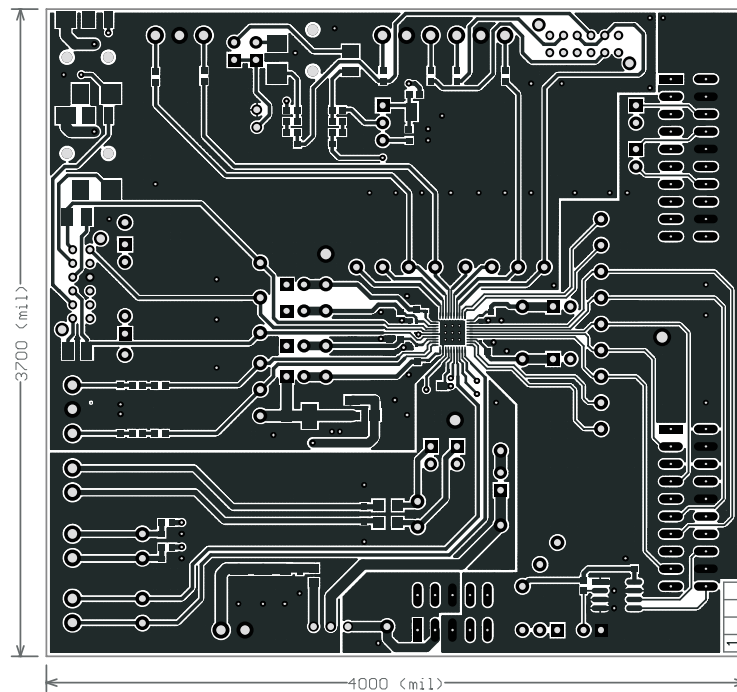

Figure C-2. Top Layer

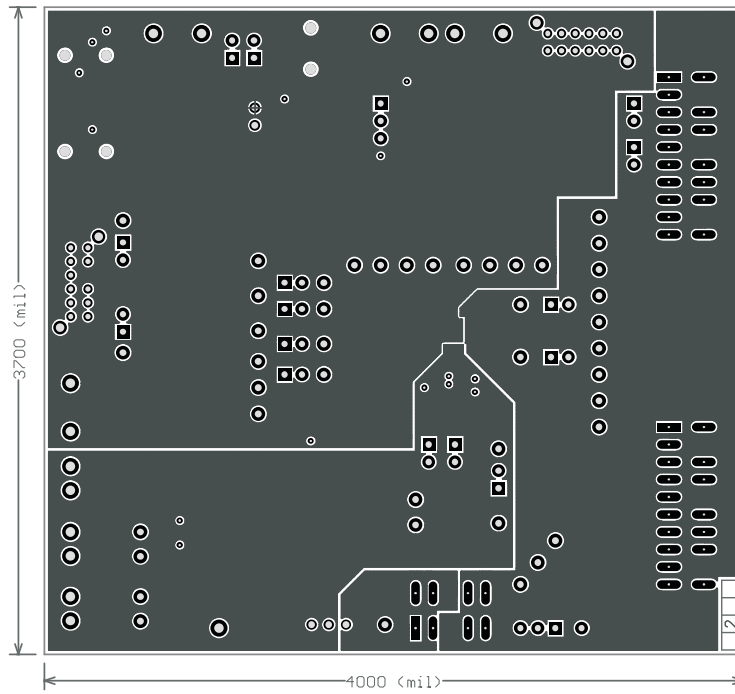

Figure C-3. Layer 3

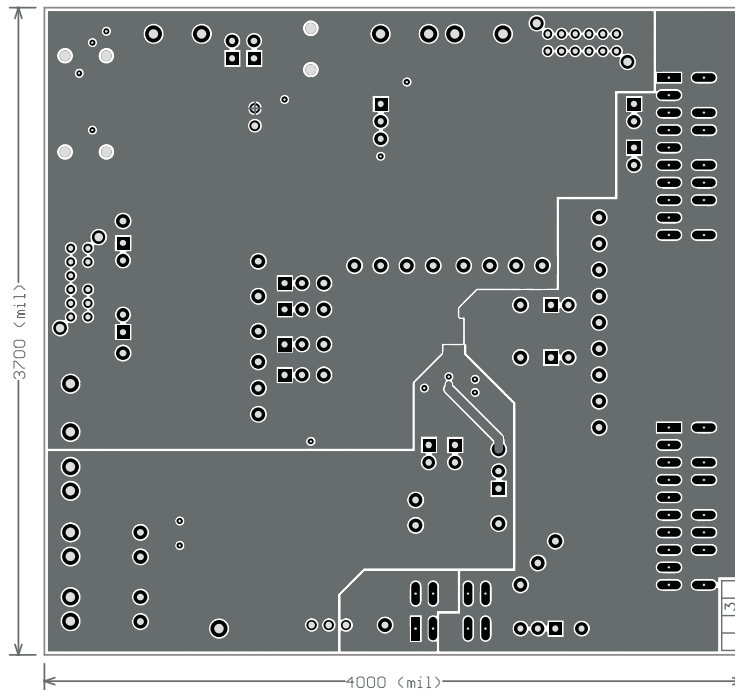
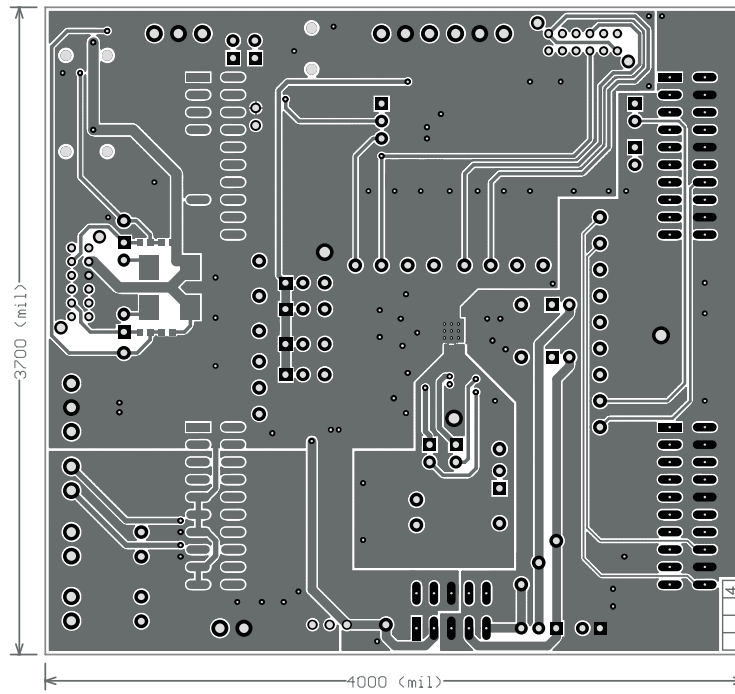

Figure C-4. Layer 4



**Figure C-5. Bottom Layer**



## Appendix D TLV320AIC3107EVM Bill of Materials

The complete bill of materials for the modular TLV320AIC3107EVM is provided as a reference.

**Table D-1. TLV320AIC3107EVM Bill of Materials**

| Item No.   | Qty | Value                            | Ref Des                          | Description                       | Vendor              | Part Number         |
|--|-----|----------------------------------|----------------------------------|-----------------------------------|---------------------|---------------------|
| <b>ATTENTION:</b>  |     |                                  |                                  |                                   |                     |                     |
| Alternate Resistor and Capacitor vendors may be used. In this case substitutions must have like descriptions.        |     |                                  |                                  |                                   |                     |                     |
| All components should be RoHS compliant. Some part numbers may be either leaded or RoHS. Verify purchased components |     |                                  |                                  |                                   |                     |                     |
| <b>PCB</b>   |     |                                  |                                  |                                   |                     |                     |
| 1  | 1   |                                  | N/A                              | TLV320AIC3107_RSB_EVM_RevA_PWB    | Texas Instruments   |                     |
| <b>RESISTORS</b>   |     |                                  |                                  |                                   |                     |                     |
| 2  | 4   | 0                                | R5, R6, R17, R18                 | RES 0 Ω 1/10W 5% 0603 SMD         | Panasonic           | ERJ-3GEY0R00V       |
| 3  | 2   | 16                               | R9, R10                          | RES 16 Ω 1W 5% 2512 SMD           | Panasonic           | ERJ-1TYJ160U        |
| 4  | 4   | 100                              | R7, R8, R11, R12                 | RES 100 Ω 1/10W 1% 0603 SMD       | Panasonic           | ERJ-3EKF1000V       |
| 5  | 1   | 220                              | R2                               | RES 220 Ω 1/10W 1% 0603 SMD       | Yageo               | RC0603FR-07220RL    |
| 6  | 2   | 402                              | R13, R14                         | RES 402 Ω 1/10W 1% 0603 SMD       | Vishay/Dale         | CRCW0603402RFKEA    |
| 7  | 2   | 2.2K                             | R3, R4                           | RES 2.2 kΩ 1/10W 5% 0603 SMD      | Panasonic           | ERJ-3GEYJ222V       |
| 8  | 1   | 2.7K                             | R19                              | RES 2.7 kΩ 1/10W 5% 0603 SMD      | Panasonic           | ERJ-3GEYJ272V       |
| 9  | 1   | 100K                             | R1                               | RES 100 kΩ 1/10W 1% 0603 SMD      | Panasonic           | ERJ-3EKF1003V       |
| <b>CAPACITORS</b>  |     |                                  |                                  |                                   |                     |                     |
| 10   | 2   | 0.022 μF                         | C37, C38                         | CAP CER 0.022 μF 50V X8R 10% 0603 | TDK Corporation     | C1608X8R1H223K      |
| 11   | 4   | 0.047 μF                         | C31–C34                          | CAP 47000PF 25 V CERM X7R 0603    | Panasonic           | ECJ-1VB1E473K       |
| 12   | 7   | 0.1 μF                           | C1–C5, C7, C8                    | CAP CER 0.10 μF 6.3V X5R 10% 0402 | TDK Corporation     | C1005X5R0J104K      |
| 13   | 11  | 0.1 μF                           | C17–C22, C24, C25, C46, C48, C52 | CAP CER 0.1 μF 25V X7R 0603       | TDK Corporation     | C1608X7R1E104K      |
| 14   | 3   | 1.0μF                            | C15, C35, C36                    | CAP CERAMIC 1 μF 10V X5R 0603     | Panasonic           | ECJ-BVB1A105K       |
| 15   | 5   | 10 μF                            | C9–C12, C16                      | CAP CERAMIC 10 μF 6.3V X5R 0603   | Panasonic           | ECJ-1VB0J106M       |
| 16   | 3   | 10 μF                            | C45, C47, C51                    | CAP CER 10UF 16V X5R 20% 1206     | TDK Corporation     | C3216X5R0J106M      |
| 17   | 1   | 22 μF                            | C13                              | CAP CER 22UF 6.3V X5R 20% 0805    | TDK Corporation     | C2012X5R0J226M      |
| 18   | 5   | 47 μF                            | C23, C29, C30, C49, C50          | CAP CER 47 μF 10V X5R 1210        | Murata              | GRM32ER61A476KE20L  |
| 19   | 5   | Not Installed                    | C26–C41, C42                     | CAP 0603                          | N/A                 | N/A                 |
| <b>PASSIVES</b>  |     |                                  |                                  |                                   |                     |                     |
| 20   | 1   | 600                              | L5                               | FERRITE CHIP 600 OHM 500MA 0805   | TDK Corporation     | MMZ2012R601A        |
| 21   | 2   | 0 (0 Ω used in place of Ferrite) | L1, L2                           | RES ZERO OHM 1/4W 5% 1206 SMD     | Panasonic           | ERJ-8GEY0R00V       |
| <b>INTEGRATED CIRCUITS</b>   |     |                                  |                                  |                                   |                     |                     |
| 22   | 1   |                                  | U1                               | Audio CODEC                       | Texas Instruments   | TLV320AIC3107IRSB   |
| 23   | 1   |                                  | U2                               | IC LDO REG 3.3V 800MA SOT-223     | Texas Instruments   | REG1117-3.3         |
| 24   | 1   |                                  | U3                               | 64K I2C EEPROM                    | MicroChip           | 24LC64-I/SN         |
| <b>MISCELLANEOUS ITEMS</b>   |     |                                  |                                  |                                   |                     |                     |
| 25   | 4   |                                  | J15– J18                         | Screw Terminal Block, 2 Position  | On Shore Technology | ED555/2DS           |
| 26   | 4   |                                  | J6–J8, J12                       | Screw Terminal Block, 3 Position  | On Shore Technology | ED555/3DS           |
| 27   | 3   |                                  | J9–J11                           | 3.5mm Audio Jack, T-R-S, SMD      | CUI Inc.            | SJ1-3515-SMT        |
| 28   |     |                                  |                                  | or alternate                      | KobiConn            | 161-3335-E          |
| 29   | 2   |                                  | P4, P5                           | 20 Pin SMT Plug                   | Samtec              | TSM-110-01-L-DV-P   |
| 30   | 4   |                                  | J1, J2, J4, J5                   | 20 pin SMT Socket                 | Samtec              | SSW-110-22-F-D-VS-K |
| 31   | 1   |                                  | P3                               | 10 Pin SMT Plug                   | Samtec              | TSM-105-01-L-DV-P   |
| 32   | 1   |                                  | J3                               | 10 pin SMT Socket                 | Samtec              | SSW-105-22-F-D-VS-K |
| 33   | 9   |                                  | W10–W13, W15–W19                 | 2 Position Jumper , 0.1" spacing  | Samtec              | TSW-102-07-L-S      |

**Table D-1. TLV320AIC3107EVM Bill of Materials (continued)**

| Item No. | Qty | Value                                | Ref Des                            | Description                          | Vendor               | Part Number    |
|----------|-----|--------------------------------------|------------------------------------|--------------------------------------|----------------------|----------------|
| 34       | 7   |                                      | W1–W5, W7, W8                      | Bus Wire (18–22 Gauge)               |                      |                |
| 35       | 2   |                                      | W9, W14                            | 3 Position Jumper , 0.1" spacing     | Samtec               | TSW-103-07-L-S |
| 36       | 1   |                                      | MK1                                | Omnidirectional Microphone Cartridge | Knowles Acoustics    | MD9745APZ-F    |
|          |     |                                      |                                    | or alternate                         | Knowles Acoustics    | MD9745APA-1    |
| 37       | 2   |                                      | SW1, SW2                           | SWITCH SLIDE 4PDT 30V RT ANGLE       | E-Switch             | EG4208         |
| 38       | 1   |                                      | SW3                                | SWITCH SLIDE SPDT 30V.2A PC MNT      | E-Switch             | EG1218         |
| 39       | 13  | <b>Not Installed</b>                 | TP1–TP5, TP7, TP8, TP41–TP45, TP49 | TEST POINT PC MINI 0.040"D RED       | Keystone Electronics | 5000           |
| 40       | 3   |                                      | TP46–TP48                          | TEST POINT PC MULTI PURPOSE BLK      | Keystone Electronics | 5011           |
| 41       | 30  | <b>Not Installed</b>                 | TP9–TP25, TP28–TP40                | TEST POINT PC MINI 0.040"D WHITE     | Keystone Electronics | 5002           |
| 42       |     | <b>Installed per test procedure.</b> | N/A                                | Header Shorting Block                | Samtec               | SNT-100-BK-T   |

## Appendix E USB-MODEVM Schematic

The schematic diagram for USB-MODEVM Interface Board (included in the TLV320AIC3107EVM-K) is provided as a reference. It appears on the following page.

| REVISION HISTORY |                           |          |
|------------------|---------------------------|----------|
| REV              | ENGINEERING CHANGE NUMBER | APPROVED |
|                  |                           |          |
|                  |                           |          |

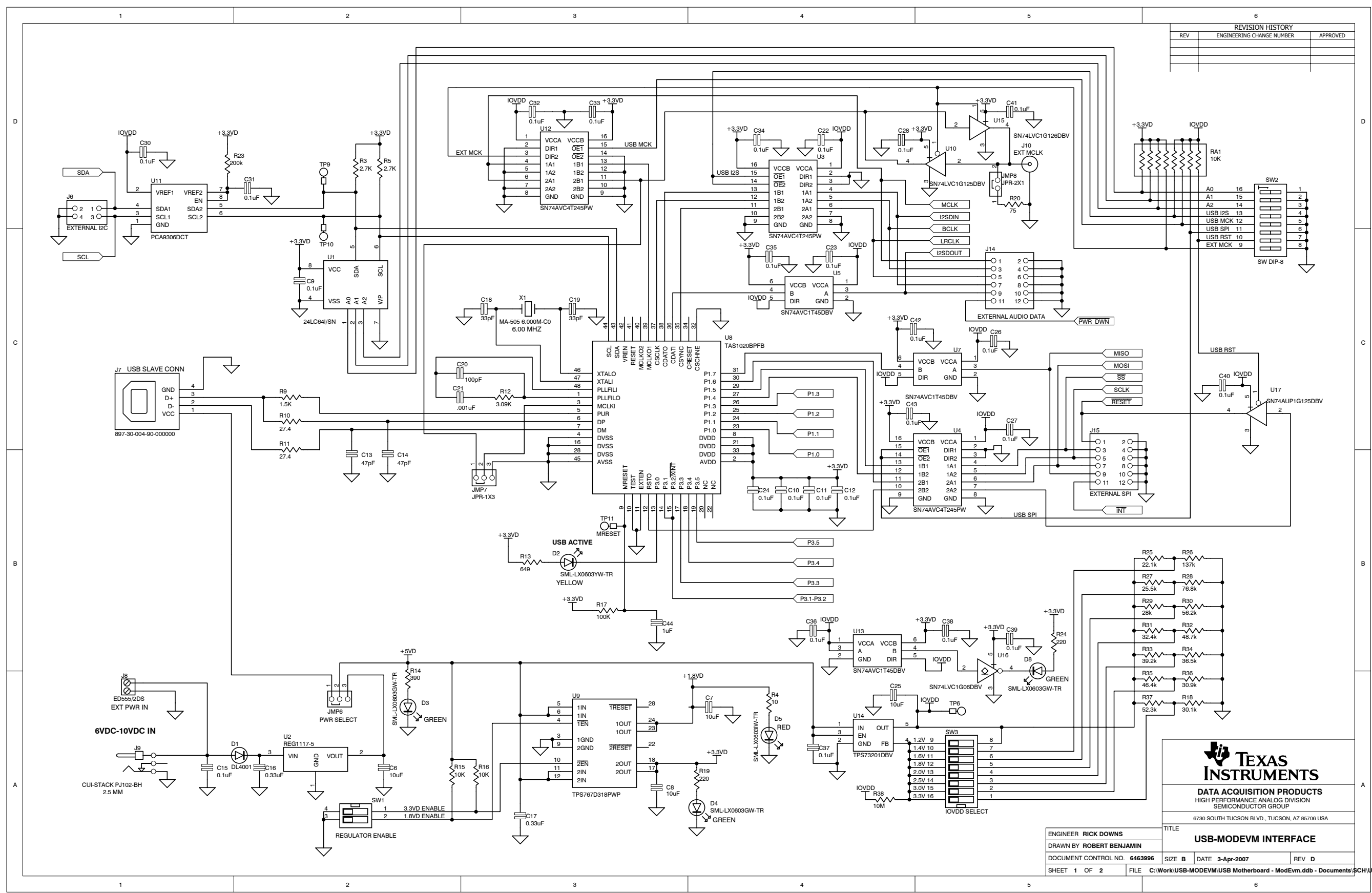

**TEXAS INSTRUMENTS**  
**DATA ACQUISITION PRODUCTS**  
 HIGH PERFORMANCE ANALOG DIVISION  
 SEMICONDUCTOR GROUP  
 6730 SOUTH TUCSON BLVD., TUCSON, AZ 85706 USA

|  |                             |
|--|-----------------------------|
| ENGINEER: RICK DOWNS   | TITLE: USB-MODEVM INTERFACE |
| DRAWN BY: ROBERT BENJAMIN  |                             |
| DOCUMENT CONTROL NO. 6463996   |                             |
| SHEET 1 OF 2   |                             |
| FILE C:\Work\USB-MODEVM\USB Motherboard - ModEvm.ddb - Documents\SCH\USB Interface |                             |

| REVISION HISTORY |                           |          |
|------------------|---------------------------|----------|
| REV              | ENGINEERING CHANGE NUMBER | APPROVED |
|                  |                           |          |
|                  |                           |          |

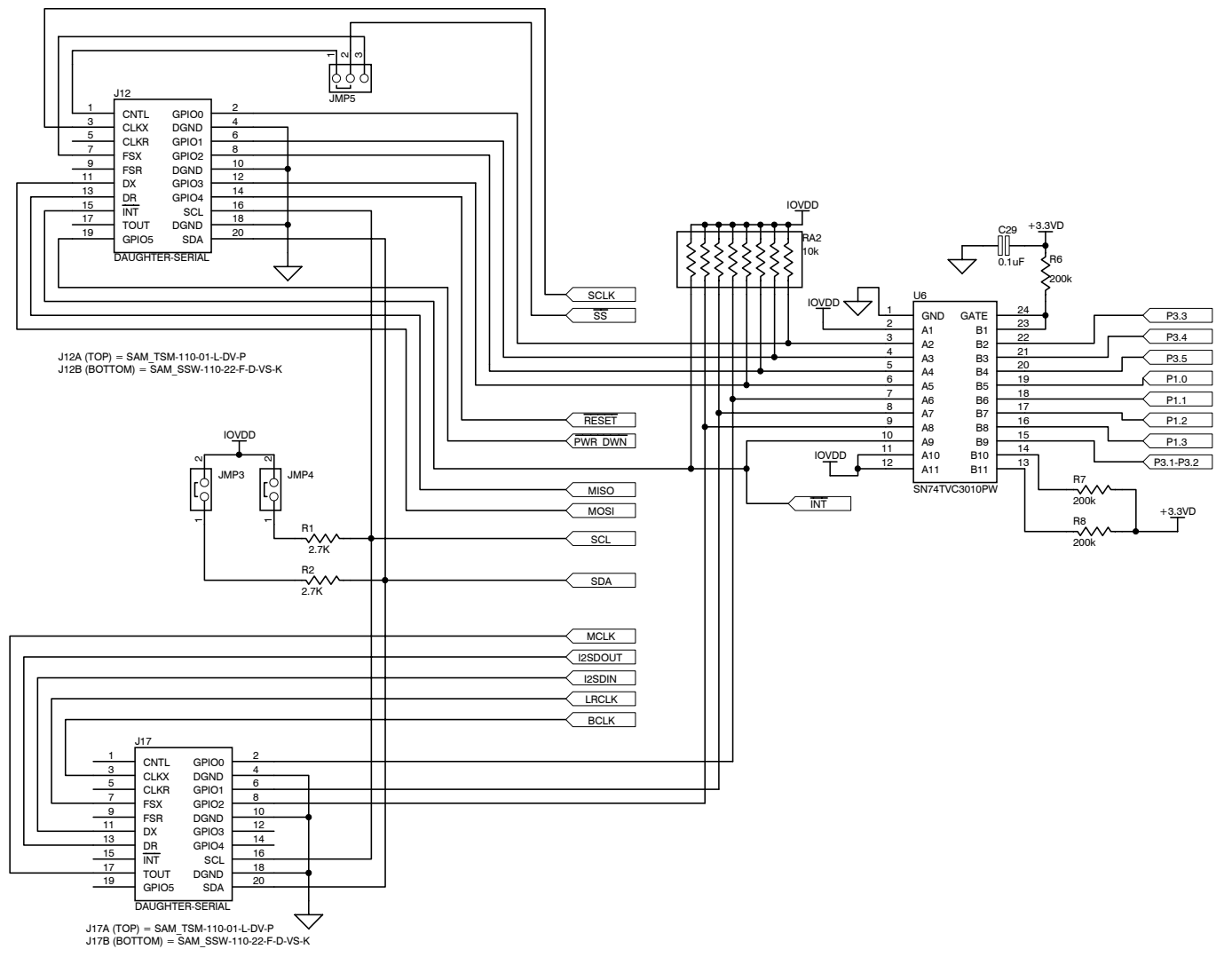
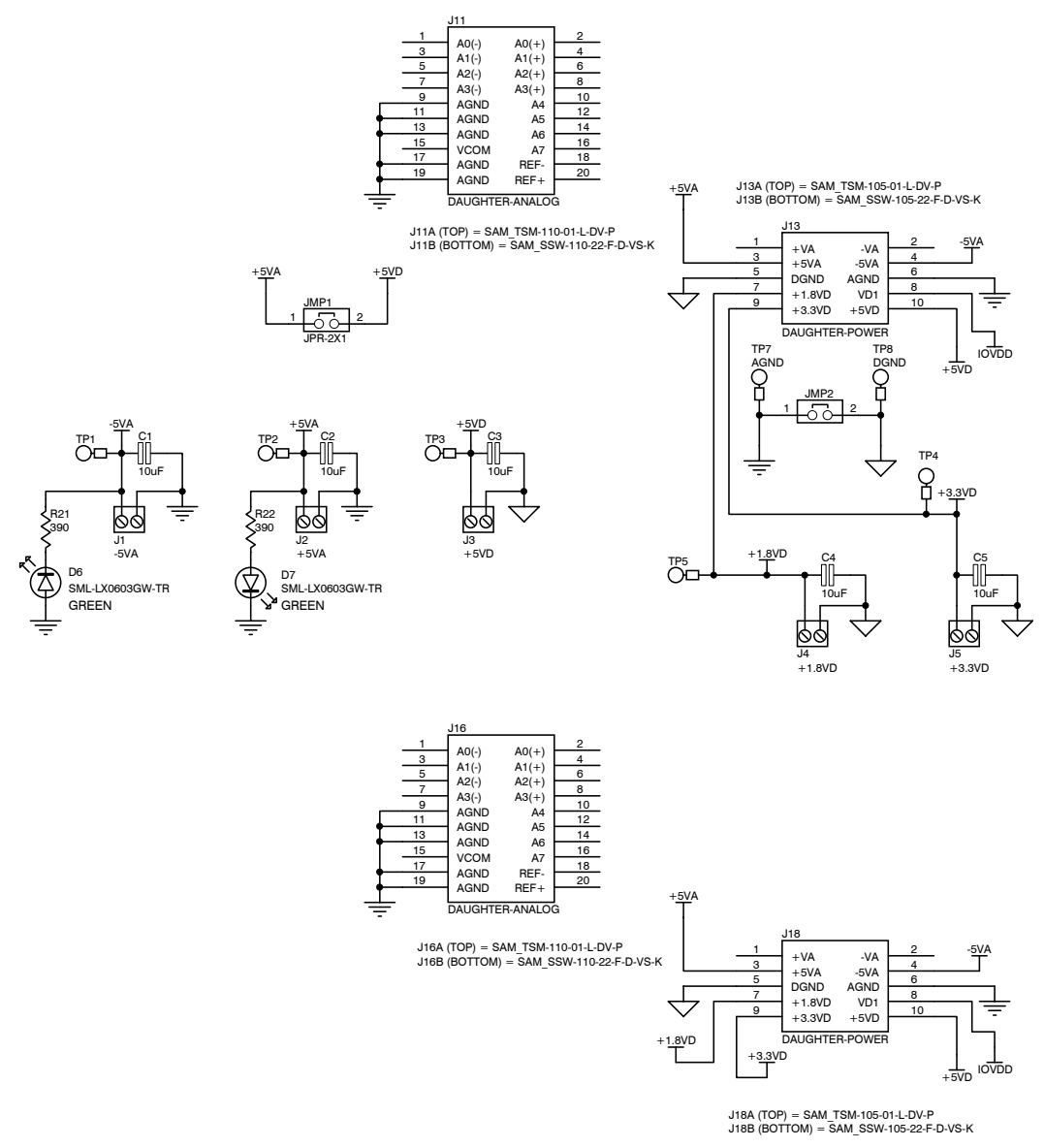

**TEXAS INSTRUMENTS**  
DATA ACQUISITION PRODUCTS  
HIGH-PERFORMANCE ANALOG DIVISION  
SEMICONDUCTOR GROUP

8730 SOUTH TUCSON BLVD., TUCSON, AZ 85706 USA

|                      |                 |       |  |
|----------------------|-----------------|-------|--|
| ENGINEER             | RICK DOWNS      | TITLE | USB-MODEVM INTERFACE   |
| DRAWN BY             | ROBERT BENJAMIN | DATE  | 3-Apr-2007   |
| DOCUMENT CONTROL NO. | 6463996         | REV   | D  |
| SHEET                | 2 OF 2          | FILE  | C:\Work\USB-MODEVM\USB Motherboard - ModEvm.ddb - Documents\SCH Daughtercard Interface |

## Appendix F USB-MODEVM Bill of Materials

The complete bill of materials for USB-MODEVM Interface Board (included only in the TLV320AIC3107EVM-K) is provided as a reference.

**Table F-1. USB-MODEVM Bill of Materials**

| Designators              | Description                                  | Manufacturer                | Mfg. Part Number     |
|--------------------------|--|-----------------------------|----------------------|
| R4                       | 10Ω 1/10W 5% Chip Resistor                   | Panasonic                   | ERJ-3GEYJ1300V       |
| R10, R11                 | 27.4Ω 1/16W 1% Chip Resistor                 | Panasonic                   | ERJ-3EKF27R4V        |
| R20                      | 75Ω 1/4W 1% Chip Resistor                    | Panasonic                   | ERJ-14NF75R0U        |
| R19                      | 220Ω 1/10W 5% Chip Resistor                  | Panasonic                   | ERJ-3GEYJ221V        |
| R14, R21, R22            | 390Ω 1/10W 5% Chip Resistor                  | Panasonic                   | ERJ-3GEYJ391V        |
| R13                      | 649Ω 1/16W 1% Chip Resistor                  | Panasonic                   | ERJ-3EKF6490V        |
| R9                       | 1.5KΩ 1/10W 5% Chip Resistor                 | Panasonic                   | ERJ-3GEYJ1352V       |
| R1–R3, R5–R8             | 2.7KΩ 1/10W 5% Chip Resistor                 | Panasonic                   | ERJ-3GEYJ272V        |
| R12                      | 3.09KΩ 1/16W 1% Chip Resistor                | Panasonic                   | ERJ-3EKF3091V        |
| R15, R16                 | 10KΩ 1/10W 5% Chip Resistor                  | Panasonic                   | ERJ-3GEYJ1303V       |
| R17, R18                 | 100kΩ 1/10W 5% Chip Resistor                 | Panasonic                   | ERJ-3GEYJ1304V       |
| RA1                      | 10KΩ 1/8W Octal Isolated Resistor Array      | CTS Corporation             | 742C163103JTR        |
| C18, C19                 | 33pF 50V Ceramic Chip Capacitor, ±5%, NPO    | TDK                         | C1608C0G1H330J       |
| C13, C14                 | 47pF 50V Ceramic Chip Capacitor, ±5%, NPO    | TDK                         | C1608C0G1H470J       |
| C20                      | 100pF 50V Ceramic Chip Capacitor, ±5%, NPO   | TDK                         | C1608C0G1H101J       |
| C21                      | 1000pF 50V Ceramic Chip Capacitor, ±5%, NPO  | TDK                         | C1608C0G1H102J       |
| C15                      | 0.1μF 16V Ceramic Chip Capacitor, ±10%, X7R  | TDK                         | C1608X7R1C104K       |
| C16, C17                 | 0.33μF 16V Ceramic Chip Capacitor, ±20%, Y5V | TDK                         | C1608X5R1C334K       |
| C9–C12, C22–C28          | 1μF 6.3V Ceramic Chip Capacitor, ±10%, X5R   | TDK                         | C1608X5R0J1305K      |
| C1–C8                    | 10μF 6.3V Ceramic Chip Capacitor, ±10%, X5R  | TDK                         | C3216X5R0J1306K      |
| D1                       | 50V, 1A, Diode MELF SMD                      | Micro Commercial Components | DL4001               |
| D2                       | Yellow Light Emitting Diode                  | Lumex                       | SML-LX0603YW-TR      |
| D3–D7                    | Green Light Emitting Diode                   | Lumex                       | SML-LX0603GW-TR      |
| D5                       | Red Light Emitting Diode                     | Lumex                       | SML-LX0603IW-TR      |
| Q1, Q2                   | N-Channel MOSFET                             | Zetex                       | ZXMN6A07F            |
| X1                       | 6MHz Crystal SMD                             | Epson                       | MA-505 6.000M-C0     |
| U8                       | USB Streaming Controller                     | Texas Instruments           | TAS1020BPFB          |
| U2                       | 5V LDO Regulator                             | Texas Instruments           | REG1117-5            |
| U9                       | 3.3V/1.8V Dual Output LDO Regulator          | Texas Instruments           | TPS767D318PWP        |
| U3, U4                   | Quad, 3-State Buffers                        | Texas Instruments           | SN74LVC125APW        |
| U5–U7                    | Single IC Buffer Driver with Open Drain o/p  | Texas Instruments           | SN74LVC1G07DBVR      |
| U10                      | Single 3-State Buffer                        | Texas Instruments           | SN74LVC1G125DBVR     |
| U1                       | 64K 2-Wire Serial EEPROM I <sup>2</sup> C    | Microchip                   | 24LC64I/SN           |
|                          | USB-MODEVM PCB                               | Texas Instruments           | 6463995              |
| TP1–TP6, TP9–TP11        | Miniature test point terminal                | Keystone Electronics        | 5000                 |
| TP7, TP8                 | Multipurpose test point terminal             | Keystone Electronics        | 5011                 |
| J7                       | USB Type B Slave Connector Thru-Hole         | Mill-Max                    | 897-30-004-90-000000 |
| J13, J2–J5, J8           | 2-position terminal block                    | On Shore Technology         | ED555/2DS            |
| J9                       | 2.5mm power connector                        | CUI Stack                   | PJ-102B              |
| J130                     | BNC connector, female, PC mount              | AMP/Tyco                    | 414305-1             |
| J131A, J132A, J21A, J22A | 20-pin SMT plug                              | Samtec                      | TSM-110-01-L-DV-P    |
| J131B, J132B, J21B, J22B | 20-pin SMT socket                            | Samtec                      | SSW-110-22-F-D-VS-K  |
| J133A, J23A              | 10-pin SMT plug                              | Samtec                      | TSM-105-01-L-DV-P    |
| J133B, J23B              | 10-pin SMT socket                            | Samtec                      | SSW-105-22-F-D-VS-K  |
| J6                       | 4-pin double row header (2x2) 0.1"           | Samtec                      | TSW-102-07-L-D       |
| J134, J135               | 12-pin double row header (2x6) 0.1"          | Samtec                      | TSW-106-07-L-D       |

**Table F-1. USB-MODEVM Bill of Materials (continued)**

| <b>Designators</b> | <b>Description</b>                       | <b>Manufacturer</b> | <b>Mfg. Part Number</b> |
|--------------------|--|---------------------|-------------------------|
| JMP1–JMP4          | 2-position jumper, 0.1" spacing          | Samtec              | TSW-102-07-L-S          |
| JMP8–JMP14         | 2-position jumper, 0.1" spacing          | Samtec              | TSW-102-07-L-S          |
| JMP5, JMP6         | 3-position jumper, 0.1" spacing          | Samtec              | TSW-103-07-L-S          |
| JMP7               | 3-position dual row jumper, 0.1" spacing | Samtec              | TSW-103-07-L-D          |
| SW1                | SMT, half-pitch 2-position switch        | C&K Division, ITT   | TDA02H0SK1              |
| SW2                | SMT, half-pitch 8-position switch        | C&K Division, ITT   | TDA08H0SK1              |
|                    | Jumper plug                              | Samtec              | SNT-100-BK-T            |

## Appendix G USB-MODEVM Protocol

### G.1 USB-MODEVM Protocol

The USB-MODEVM is defined to be a Vendor-Specific class, and is identified on the PC system as an NI-VISA device. Because the TAS1020 has several routines in its ROM which are designed for use with HID-class devices, HID-like structures are used, even though the USB-MODEVM is not an HID-class device. Data is passed from the PC to the TAS1020 using the control endpoint.

Data is sent in an HIDSETREPORT (see [Table G-1](#)):

**Table G-1. USB Control Endpoint  
HIDSETREPORT Request**

| Part          | Value              | Description                    |
|---------------|--------------------|--------------------------------|
| bmRequestType | 0x21               | 00100001                       |
| bRequest      | 0x09               | SET_REPORT                     |
| wValue        | 0x00               | don't care                     |
| wIndex        | 0x03               | HID interface is index 3       |
| wLength       | calculated by host |                                |
| Data          |                    | Data packet as described below |

The data packet consists of the following bytes, shown in [Table G-2](#):

**Table G-2. Data Packet Configuration**

| Byte Number | Type                           | Description  |
|-------------|--------------------------------|--|
| 0           | Interface                      | Specifies serial interface and operation. The two values are logically ORed.<br>Operation:<br>READ      0x00<br>WRITE     0x10<br>Interface:<br>GPIO      0x08<br>SPI_16    0x04<br>I2C_FAST  0x02<br>I2C_STD   0x01<br>SPI_8     0x00 |
| 1           | I <sup>2</sup> C Slave Address | Slave address of I <sup>2</sup> C device or MSB of 16-bit reg addr for SPI   |
| 2           | Length                         | Length of data to write/read (number of bytes)   |
| 3           | Register address               | Address of register for I <sup>2</sup> C or 8-bit SPI; LSB of 16-bit address for SPI   |
| 4..64       | Data                           | Up to 60 data bytes could be written at a time. EP0 maximum length is 64. The return packet is limited to 42 bytes, so advise only sending 32 bytes at any one time.   |

Example usage:

Write two bytes (AA, 55) to device starting at register 5 of an I<sup>2</sup>C device with address A0:

```
[ 0]    0x11
[ 1]    0xA0
[ 2]    0x02
[ 3]    0x05
[ 4]    0xAA
[ 5]    0x55
```



Do the same with a fast mode I<sup>2</sup>C device:

```
[0] 0x12
[1] 0xA0
[2] 0x02
[3] 0x05
[4] 0xAA
[5] 0x55
```

Now with an SPI device which uses an 8-bit register address:

```
[0] 0x10
[1] 0xA0
[2] 0x02
[3] 0x05
[4] 0xAA
[5] 0x55
```

Now consider a 16-bit register address, as found on parts like the TSC2101. Assume that the register address (command word) is **0x10E0**:

```
[0] 0x14
[1] 0x10 --> Note: the I2C address now serves as MSB of reg addr.
[2] 0x02
[3] 0xE0
[4] 0xAA
[5] 0x55
```

In each case, the TAS1020 returns, in an HID interrupt packet, the following:

[0] interface byte | status

status:

REQ\_ERROR 0x80

INTF\_ERROR 0x40

REQ\_DONE 0x20

[1] for I<sup>2</sup>C interfaces, the I<sup>2</sup>C address as sent

for SPI interfaces, the read back data from SPI line for transmission of the corresponding byte

[2] length as sent

[3] for I<sup>2</sup>C interfaces, the reg address as sent

for SPI interfaces, the read back data from SPI line for transmission of the corresponding byte

[4..60] echo of data packet sent

If the command is sent with no problem, the returning byte [0] is the same as the sent one logically ORed with 0x20 - in the preceding first example, the returning packet is:

```
[0]    0x31
[1]    0xA0
[2]    0x02
[3]    0x05
[4]    0xAA
[5]    0x55
```

If for some reason the interface fails (for example, the I<sup>2</sup>C device does not acknowledge), it comes back as:

```
[0]    0x51 --> interface | INTF_ERROR
[1]    0xA0
[2]    0x02
[3]    0x05
[4]    0xAA
[5]    0x55
```

If the request is malformed, that is, the interface byte (byte [0]) takes on a value which is not as preciously described, the return packet is:

```
[0]    0x93 --> the user sent 0x13, which is not valid, so 0x93 returned
[1]    0xA0
[2]    0x02
[3]    0x05
[4]    0xAA
[5]    0x55
```

The preceding examples used writes. Reading is similar:

Read two bytes from device starting at register 5 of an I<sup>2</sup>C device with address A0:

```
[0]    0x01
[1]    0xA0
[2]    0x02
[3]    0x05
```

The return packet is:

```
[0]    0x21
[1]    0xA0
[2]    0x02
[3]    0x05
[4]    0xAA
[5]    0x55
```

assuming that the preceding values starting at Register 5 were actually written to the device.

## G.2 GPIO Capability

The USB-MODEVM has seven GPIO lines. Access them by specifying the interface to be 0x08, and then using the standard format for packets—but addresses are unnecessary. The GPIO lines are mapped into one byte (see [Table G-3](#)):

**Table G-3. GPIO Pin Assignments**

| Bit 7 | 6    | 5    | 4    | 3    | 2    | 1    | 0    |
|-------|------|------|------|------|------|------|------|
| x     | P3.5 | P3.4 | P3.3 | P1.3 | P1.2 | P1.1 | P1.0 |

Example: write P3.5 to a 1, set all others to 0:

```
[0] 0x18 --> write, GPIO
[1] 0x00 --> this value is ignored
[2] 0x01 --> length - ALWAYS a 1
[3] 0x00 --> this value is ignored
[4] 0x40 --> 01000000
```

The user may also read back from the GPIO to see the state of the pins. Let's say we just wrote the previous example to the port pins.

Example: read the GPIO

```
[0] 0x08 --> read, GPIO
[1] 0x00 --> this value is ignored
[2] 0x01 --> length - ALWAYS a 1
[3] 0x00 --> this value is ignored
```

The return packet should be:

```
[0] 0x28
[1] 0x00
[2] 0x01
[3] 0x00
[4] 0x40
```

### G.3 Writing Scripts

A script is simply a text file that contains data to send to the serial control buses. The scripting language is simple, as is the parser for the language. Therefore, although the program is not forgiving about mistakes made in the source script file, the formatting of the file is simple. Consequently, mistakes are rare.

Each line in a script file is one command. Lines cannot be extended beyond one line. A line is terminated by a carriage return.

The first character of a line is the command. Commands are:

- I** Set interface bus to use
- r** Read from the serial control bus
- w** Write to the serial control bus
- #** Comment
- b** Break
- d** Delay

The first command, **I**, sets the interface to use for the commands to follow. This command must be followed by one of the following parameters:

|                |   |
|----------------|---|
| <b>i2cstd</b>  | Standard mode I <sup>2</sup> C bus      |
| <b>i2cfast</b> | Fast mode I <sup>2</sup> C bus          |
| <b>spi8</b>    | SPI bus with 8-bit register addressing  |
| <b>spi16</b>   | SPI bus with 16-bit register addressing |
| <b>gpio</b>    | Use the USB-MODEVM GPIO capability      |

For example, if a fast mode I<sup>2</sup>C bus is to be used, the script begins with:

#### **I i2cfast**

No data follows the break command. Anything following a comment command is ignored by the parser, provided that it is on the same line. The delay command allows the user to specify a time, in milliseconds, that the script pauses before proceeding.

---

**Note:** Unlike all other numbers used in the script commands, the delay time is entered in a decimal format. Also, note that because of latency in the USB bus as well as the time it takes the processor on the USB-MODEVM to handle requests, the delay time may not be precise.

---

A series of byte values follows either a read or write command. Each byte value is expressed in hexadecimal, and each byte must be separated by a space. Commands are interpreted and sent to the TAS1020 by the program using the protocol described in [Section G.1](#).

The first byte following a read or write command is the I<sup>2</sup>C slave address of the device (if I<sup>2</sup>C is used) or the first data byte to write (if SPI is used—note that SPI interfaces are not standardized on protocols, so the meaning of this byte varies with the device being addressed on the SPI bus). The second byte is the starting register address that data is written to (again, with I<sup>2</sup>C; SPI varies—see [Section G.1](#) for additional information about what variations may be necessary for a particular SPI mode). Following these two bytes are data, if writing; if reading, the third byte value is the number of bytes to read, (expressed in hexadecimal).

For example, to write the values 0xAA 0x55 to an I<sup>2</sup>C device with a slave address of 0x90, starting at a register address of 0x03, one would write:

```
#example script
I i2cfast
w 90 03 AA 55
r 90 03 2
```

This script begins with a comment, specifies that a fast I<sup>2</sup>C bus is used, then writes `0xAA 0x55` to the I<sup>2</sup>C slave device at address `0x90`, writing the values into registers `0x03` and `0x04`. The script then reads back two bytes from the same device starting at register address `0x03`. Note that the slave device value does not change. It is unnecessary to set the R/W bit for I<sup>2</sup>C devices in the script; the read or write commands does that.

Here is an example of using an SPI device that requires 16-bit register addresses:

```
# setup TSC2101 for input and output
# uses SPI16 interface
# this script sets up DAC and ADC at full volume, input from onboard mic
#
# Page 2: Audio control registers
w 10 00 00 00 80 00 00 00 45 31 44 FD 40 00 31 C4
w 13 60 11 20 00 00 00 80 7F 00 C5 FE 31 40 7C 00 02 00 C4 00 00 00 23 10 FE
00 FE 00
```

Note that blank lines are allowed. However, be sure that the script does not end with a blank line. Although ending with a blank line does not cause the script to fail, the program does execute that line, and therefore, may prevent the user from seeing data that was written or read back on the previous command.

In this example, the first two bytes of each command are the command word to send to the TSC2101 (`0x1000`, `0x1360`); these are followed by data to write to the device starting at the address specified in the command word. The second line may wrap in the viewer being used to look like more than one line; careful examination shows, however, that only one carriage return is on that line, following the last `00`.

Any text editor can be used to write these scripts; Jedit is an editor that is highly recommended for general usage. For more information, go to: <http://www.jedit.org>.

Once the script is written, it can be used in the command window by running the program, and then selecting *Open Command File...* from the File menu. Locate the script and open it. The script then is displayed in the command buffer. The user can also edit the script once it is in the buffer, but saving of the command buffer is not possible at this time (this feature may be added at a later date).

Once the script is in the command buffer, it may be executed by pressing the *Execute Command Buffer* button. If breakpoints are in the script, the script executes to that point, and the user is presented with a dialog box with a button to press to continue executing the script. When ready to proceed, push that button and the script continues.

Here an example of a (partial) script with breakpoints using the AIC33EVM as an example:

```
# setup AIC33 for input and output
# uses I2C interface
I i2cfast
# reg 07 - codec datapath
w 30 07 8A
r 30 07 1
d 1000
# regs 15/16 - ADC volume, unmute and set to 0dB
w 30 0F 00 00
r 30 0F 2
b
```

This script writes the value `8A` at register `7`, then reads it back to verify that the write was good. A delay of `1000 ms` (one second) is placed after the read to pause the script operation. When the script continues, the values `00 00` is written starting at register `0F`. This output is verified by reading two bytes, and pausing the script again, this time with a break. The script does not continue until the user allows it to by pressing *OK* in the dialog box that is displayed due to the break.

## EVALUATION BOARD/KIT IMPORTANT NOTICE

Texas Instruments (TI) provides the enclosed product(s) under the following conditions:

This evaluation board/kit is intended for use for **ENGINEERING DEVELOPMENT, DEMONSTRATION, OR EVALUATION PURPOSES ONLY** and is not considered by TI to be a finished end-product fit for general consumer use. Persons handling the product(s) must have electronics training and observe good engineering practice standards. As such, the goods being provided are not intended to be complete in terms of required design-, marketing-, and/or manufacturing-related protective considerations, including product safety and environmental measures typically found in end products that incorporate such semiconductor components or circuit boards. This evaluation board/kit does not fall within the scope of the European Union directives regarding electromagnetic compatibility, restricted substances (RoHS), recycling (WEEE), FCC, CE or UL, and therefore may not meet the technical requirements of these directives or other related directives.

Should this evaluation board/kit not meet the specifications indicated in the User's Guide, the board/kit may be returned within 30 days from the date of delivery for a full refund. **THE FOREGOING WARRANTY IS THE EXCLUSIVE WARRANTY MADE BY SELLER TO BUYER AND IS IN LIEU OF ALL OTHER WARRANTIES, EXPRESSED, IMPLIED, OR STATUTORY, INCLUDING ANY WARRANTY OF MERCHANTABILITY OR FITNESS FOR ANY PARTICULAR PURPOSE.**

The user assumes all responsibility and liability for proper and safe handling of the goods. Further, the user indemnifies TI from all claims arising from the handling or use of the goods. Due to the open construction of the product, it is the user's responsibility to take any and all appropriate precautions with regard to electrostatic discharge.

**EXCEPT TO THE EXTENT OF THE INDEMNITY SET FORTH ABOVE, NEITHER PARTY SHALL BE LIABLE TO THE OTHER FOR ANY INDIRECT, SPECIAL, INCIDENTAL, OR CONSEQUENTIAL DAMAGES.**

TI currently deals with a variety of customers for products, and therefore our arrangement with the user **is not exclusive.**

TI assumes **no liability for applications assistance, customer product design, software performance, or infringement of patents or services described herein.**

Please read the User's Guide and, specifically, the Warnings and Restrictions notice in the User's Guide prior to handling the product. This notice contains important safety information about temperatures and voltages. For additional information on TI's environmental and/or safety programs, please contact the TI application engineer or visit [www.ti.com/esh](http://www.ti.com/esh).

No license is granted under any patent right or other intellectual property right of TI covering or relating to any machine, process, or combination in which such TI products or services might be or are used.

### FCC Warning

This evaluation board/kit is intended for use for **ENGINEERING DEVELOPMENT, DEMONSTRATION, OR EVALUATION PURPOSES ONLY** and is not considered by TI to be a finished end-product fit for general consumer use. It generates, uses, and can radiate radio frequency energy and has not been tested for compliance with the limits of computing devices pursuant to part 15 of FCC rules, which are designed to provide reasonable protection against radio frequency interference. Operation of this equipment in other environments may cause interference with radio communications, in which case the user at his own expense will be required to take whatever measures may be required to correct this interference.

### EVM WARNINGS AND RESTRICTIONS

It is important to operate this EVM within the input voltage range of 3.3 V to 5 V and the output voltage range of 0 V to 5 V.

Exceeding the specified input range may cause unexpected operation and/or irreversible damage to the EVM. If there are questions concerning the input range, please contact a TI field representative prior to connecting the input power.

Applying loads outside of the specified output range may result in unintended operation and/or possible permanent damage to the EVM. Please consult the EVM User's Guide prior to connecting any load to the EVM output. If there is uncertainty as to the load specification, please contact a TI field representative.

During normal operation, some circuit components may have case temperatures greater than 30°C. The EVM is designed to operate properly with certain components above 85°C as long as the input and output ranges are maintained. These components include but are not limited to linear regulators, switching transistors, pass transistors, and current sense resistors. These types of devices can be identified using the EVM schematic located in the EVM User's Guide. When placing measurement probes near these devices during operation, please be aware that these devices may be very warm to the touch.

Mailing Address: Texas Instruments, Post Office Box 655303, Dallas, Texas 75265  
Copyright © 2008, Texas Instruments Incorporated

## IMPORTANT NOTICE

Texas Instruments Incorporated and its subsidiaries (TI) reserve the right to make corrections, modifications, enhancements, improvements, and other changes to its products and services at any time and to discontinue any product or service without notice. Customers should obtain the latest relevant information before placing orders and should verify that such information is current and complete. All products are sold subject to TI's terms and conditions of sale supplied at the time of order acknowledgment.

TI warrants performance of its hardware products to the specifications applicable at the time of sale in accordance with TI's standard warranty. Testing and other quality control techniques are used to the extent TI deems necessary to support this warranty. Except where mandated by government requirements, testing of all parameters of each product is not necessarily performed.

TI assumes no liability for applications assistance or customer product design. Customers are responsible for their products and applications using TI components. To minimize the risks associated with customer products and applications, customers should provide adequate design and operating safeguards.

TI does not warrant or represent that any license, either express or implied, is granted under any TI patent right, copyright, mask work right, or other TI intellectual property right relating to any combination, machine, or process in which TI products or services are used. Information published by TI regarding third-party products or services does not constitute a license from TI to use such products or services or a warranty or endorsement thereof. Use of such information may require a license from a third party under the patents or other intellectual property of the third party, or a license from TI under the patents or other intellectual property of TI.

Reproduction of TI information in TI data books or data sheets is permissible only if reproduction is without alteration and is accompanied by all associated warranties, conditions, limitations, and notices. Reproduction of this information with alteration is an unfair and deceptive business practice. TI is not responsible or liable for such altered documentation. Information of third parties may be subject to additional restrictions.

Resale of TI products or services with statements different from or beyond the parameters stated by TI for that product or service voids all express and any implied warranties for the associated TI product or service and is an unfair and deceptive business practice. TI is not responsible or liable for any such statements.

TI products are not authorized for use in safety-critical applications (such as life support) where a failure of the TI product would reasonably be expected to cause severe personal injury or death, unless officers of the parties have executed an agreement specifically governing such use. Buyers represent that they have all necessary expertise in the safety and regulatory ramifications of their applications, and acknowledge and agree that they are solely responsible for all legal, regulatory and safety-related requirements concerning their products and any use of TI products in such safety-critical applications, notwithstanding any applications-related information or support that may be provided by TI. Further, Buyers must fully indemnify TI and its representatives against any damages arising out of the use of TI products in such safety-critical applications.

TI products are neither designed nor intended for use in military/aerospace applications or environments unless the TI products are specifically designated by TI as military-grade or "enhanced plastic." Only products designated by TI as military-grade meet military specifications. Buyers acknowledge and agree that any such use of TI products which TI has not designated as military-grade is solely at the Buyer's risk, and that they are solely responsible for compliance with all legal and regulatory requirements in connection with such use.

TI products are neither designed nor intended for use in automotive applications or environments unless the specific TI products are designated by TI as compliant with ISO/TS 16949 requirements. Buyers acknowledge and agree that, if they use any non-designated products in automotive applications, TI will not be responsible for any failure to meet such requirements.

Following are URLs where you can obtain information on other Texas Instruments products and application solutions:

### Products

|                             |  |
|-----------------------------|--|
| Amplifiers                  | <a href="http://amplifier.ti.com">amplifier.ti.com</a>             |
| Data Converters             | <a href="http://dataconverter.ti.com">dataconverter.ti.com</a>     |
| DSP                         | <a href="http://dsp.ti.com">dsp.ti.com</a>                         |
| Clocks and Timers           | <a href="http://www.ti.com/clocks">www.ti.com/clocks</a>           |
| Interface                   | <a href="http://interface.ti.com">interface.ti.com</a>             |
| Logic                       | <a href="http://logic.ti.com">logic.ti.com</a>                     |
| Power Mgmt                  | <a href="http://power.ti.com">power.ti.com</a>                     |
| Microcontrollers            | <a href="http://microcontroller.ti.com">microcontroller.ti.com</a> |
| RFID                        | <a href="http://www.ti-rfid.com">www.ti-rfid.com</a>               |
| RF/IF and ZigBee® Solutions | <a href="http://www.ti.com/lprf">www.ti.com/lprf</a>               |

### Applications

|                    |  |
|--------------------|--|
| Audio              | <a href="http://www.ti.com/audio">www.ti.com/audio</a>                   |
| Automotive         | <a href="http://www.ti.com/automotive">www.ti.com/automotive</a>         |
| Broadband          | <a href="http://www.ti.com/broadband">www.ti.com/broadband</a>           |
| Digital Control    | <a href="http://www.ti.com/digitalcontrol">www.ti.com/digitalcontrol</a> |
| Medical            | <a href="http://www.ti.com/medical">www.ti.com/medical</a>               |
| Military           | <a href="http://www.ti.com/military">www.ti.com/military</a>             |
| Optical Networking | <a href="http://www.ti.com/opticalnetwork">www.ti.com/opticalnetwork</a> |
| Security           | <a href="http://www.ti.com/security">www.ti.com/security</a>             |
| Telephony          | <a href="http://www.ti.com/telephony">www.ti.com/telephony</a>           |
| Video & Imaging    | <a href="http://www.ti.com/video">www.ti.com/video</a>                   |
| Wireless           | <a href="http://www.ti.com/wireless">www.ti.com/wireless</a>             |

Mailing Address: Texas Instruments, Post Office Box 655303, Dallas, Texas 75265  
Copyright © 2008, Texas Instruments Incorporated



## Стандарт Электрон Связь

Мы молодая и активно развивающаяся компания в области поставок электронных компонентов. Мы поставляем электронные компоненты отечественного и импортного производства напрямую от производителей и с крупнейших складов мира.

Благодаря сотрудничеству с мировыми поставщиками мы осуществляем комплексные и плановые поставки широчайшего спектра электронных компонентов.

Собственная эффективная логистика и склад в обеспечивает надежную поставку продукции в точно указанные сроки по всей России.

Мы осуществляем техническую поддержку нашим клиентам и предпродажную проверку качества продукции. На все поставляемые продукты мы предоставляем гарантию .

Осуществляем поставки продукции под контролем ВП МО РФ на предприятия военно-промышленного комплекса России , а также работаем в рамках 275 ФЗ с открытием отдельных счетов в уполномоченном банке. Система менеджмента качества компании соответствует требованиям ГОСТ ISO 9001.

Минимальные сроки поставки, гибкие цены, неограниченный ассортимент и индивидуальный подход к клиентам являются основой для выстраивания долгосрочного и эффективного сотрудничества с предприятиями радиоэлектронной промышленности, предприятиями ВПК и научно-исследовательскими институтами России.

С нами вы становитесь еще успешнее!

### Наши контакты:

**Телефон:** +7 812 627 14 35

**Электронная почта:** [sales@st-electron.ru](mailto:sales@st-electron.ru)

**Адрес:** 198099, Санкт-Петербург,  
Промышленная ул, дом № 19, литера Н,  
помещение 100-Н Офис 331