

CGHV27015S

15 W, DC - 6.0 GHz, 50 V, GaN HEMT

Cree's CGHV27015S is an unmatched, gallium nitride (GaN) high electron mobility transistor (HEMT) designed specifically for high efficiency, high gain and wide bandwidth capabilities, which makes the CGHV27015S ideal for LTE, 4G Telecom and BWA amplifier applications. The CGHV27015S GaN HEMT device is unmatched so it is suitable for power amplifier applications from 10MHz through 6000 MHz, such as tactical communications, CATV, UAV data links, as well as a driver stage amplifier for RADAR, EW, and SatCom devices. At a V_{dd} of 50 V, the device provide 2.5W of average power or 15W of peak power. At a V_{dd} of 28V, the device provides 1W of average power and 7W of peak power. The transistor is available in a 3mm x 4mm, surface mount, dual-flat-no-lead (DFN) package.

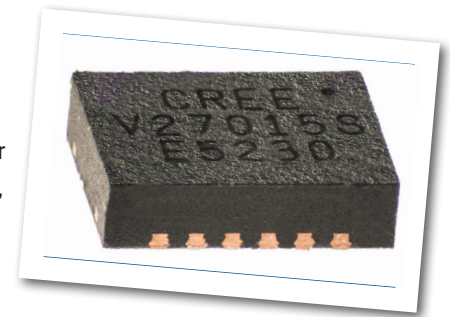

Package Type: 3x4 DFN
PN: CGHV27015S

Typical Performance 2.4-2.7 GHz (T_c = 25°C), 50 V

Parameter	2.4 GHz	2.5 GHz	2.6 GHz	2.7 GHz	Units
Small Signal Gain	23	22	21.7	21.2	dB
Adjacent Channel Power @ P _{OUT} = 2.5 W	-36.7	-40.7	-42.4	-42.5	dBc
Drain Efficiency @ P _{OUT} = 2.5 W	35.9	33.5	30.4	30.2	%
Input Return Loss	-9.312	-9.6	-8.6	-7.8	dB

Note:
Measured in the CGHV27015S-AMP1 application circuit.
Under 7.5 dB PAR single carrier WCDMA signal test model 1 with 64 DPCH.

Features for 50 V in CGHV27015S-AMP1

- 2.4 - 2.7 GHz Operation
- 15 W Typical Output Power
- 21 dB Gain at 2.5 W P_{AVE}
- -38 dBc ACLR at 2.5 W P_{AVE}
- 32% efficiency at 2.5 W P_{AVE}
- High degree of APD and DPD correction can be applied

Large Signal Models Available for ADS and MWO

Absolute Maximum Ratings (not simultaneous) at 25°C Case Temperature

Parameter	Symbol	Rating	Units	Notes
Drain-Source Voltage	V_{DS}	125	Volts	25°C
Gate-to-Source Voltage	V_{GS}	-10, +2	Volts	25°C
Storage Temperature	T_{STG}	-65, +150	°C	
Operating Junction Temperature	T_J	225	°C	
Maximum Forward Gate Current	I_{GMAX}	2	mA	25°C
Maximum Drain Current ¹	I_{DMAX}	0.9	A	25°C
Soldering Temperature ²	T_S	245	°C	
Case Operating Temperature ³	T_C	-40, +150	°C	
Thermal Resistance, Junction to Case ⁴	$R_{\theta JC}$	11.1	°C/W	85°C

Note:

¹ Current limit for long term, reliable operation

² Refer to the Application Note on soldering at www.cree.com/rf/document-library

³ T_C = Case temperature for the device. It refers to the temperature at the ground tab underneath the package. The PCB will add additional thermal resistance. See also, the Power Dissipation De-rating Curve on page 7.

⁴ Measured for the CGHV27015S at $P_{DISS} = 5$ W

⁵ The $R_{\theta TH}$ for Cree's demonstration amplifier, CGHV27015S-AMP1, with 31 x 0.011 via holes designed on a 20 mil thick Rogers 4350 PCB, is 3.9°C. The total $R_{\theta TH}$ from the heat sink to the junction is 11.1°C + 3.9°C = 15°C/W.

Electrical Characteristics ($T_C = 25^\circ\text{C}$)

Characteristics	Symbol	Min.	Typ.	Max.	Units	Conditions
DC Characteristics¹						
Gate Threshold Voltage	$V_{GS(th)}$	-3.8	-3.0	-2.3	V_{DC}	$V_{DS} = 10$ V, $I_D = 2$ mA
Gate Quiescent Voltage	$V_{GS(Q)}$	-	-2.6	-	V_{DC}	$V_{DS} = 50$ V, $I_D = 60$ mA
Saturated Drain Current	I_{DS}	1.48	1.78	-	A	$V_{DS} = 6.0$ V, $V_{GS} = 2.0$ V
Drain-Source Breakdown Voltage	$V_{(BR)DSS}$	150	-	-	V_{DC}	$V_{GS} = -8$ V, $I_D = 2$ mA
RF Characteristics^{2,3} ($T_C = 25^\circ\text{C}$, $F_0 = 2.7$ GHz unless otherwise noted)						
Gain	G	-	21.6	-	dB	$V_{DD} = 50$ V, $I_{DQ} = 60$ mA, $P_{IN} = 10$ dBm
Output Power ⁴	P_{OUT}	-	41.9	-	dBm	$V_{DD} = 50$ V, $I_{DQ} = 60$ mA, $P_{IN} = 25$ dBm
Drain Efficiency ⁴	η	-	67	-	%	$V_{DD} = 50$ V, $I_{DQ} = 60$ mA, $P_{IN} = 25$ dBm
Output Mismatch Stress ⁴	VSWR	-	10 : 1	-	Ψ	No damage at all phase angles, $V_{DD} = 50$ V, $I_{DQ} = 60$ mA, $P_{IN} = 25$ dBm
Dynamic Characteristics						
Input Capacitance ⁵	C_{GS}	-	3.15	-	pF	$V_{DS} = 50$ V, $V_{gs} = -8$ V, $f = 1$ MHz
Output Capacitance ⁵	C_{DS}	-	1.06	-	pF	$V_{DS} = 50$ V, $V_{gs} = -8$ V, $f = 1$ MHz
Feedback Capacitance	C_{GD}	-	0.058	-	pF	$V_{DS} = 50$ V, $V_{gs} = -8$ V, $f = 1$ MHz

Notes:

¹ Measured on wafer prior to packaging

² Scaled from PCM data

³ Measured in Cree's production test fixture. This fixture is designed for high volume test at 2.7 GHz

⁴ Un-modulated pulsed signal, 100 μ s, 10% duty cycle

⁵ Includes package and internal matching components

Typical Performance in Application Circuit CGHV27015S-AMP1

Figure 1. - Small Signal Gain and Return Losses vs Frequency
 $V_{DD} = 50\text{ V}, I_{DQ} = 60\text{ mA}$

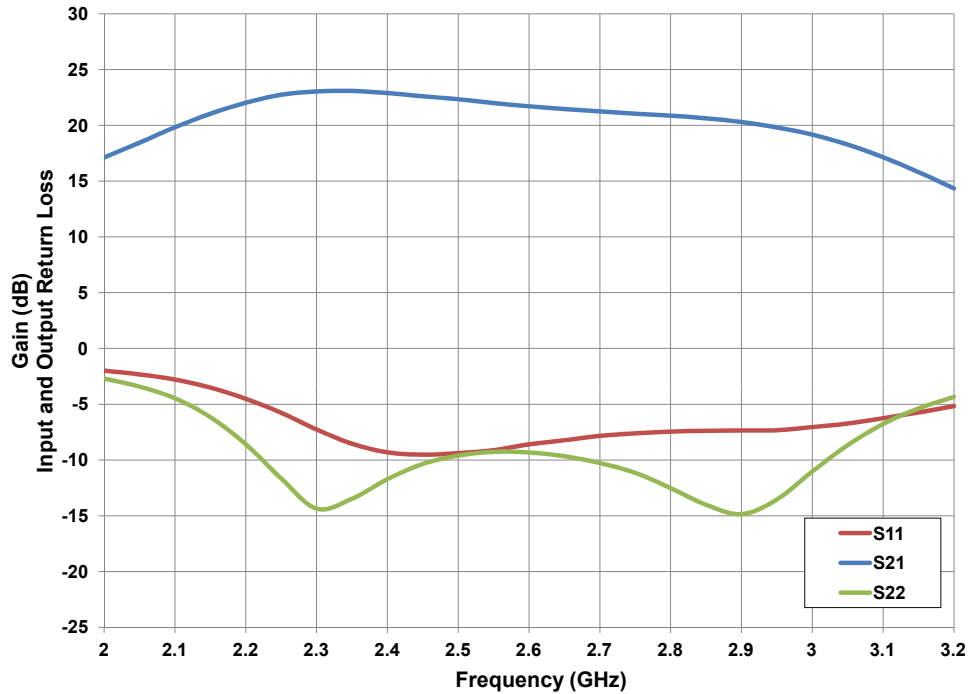
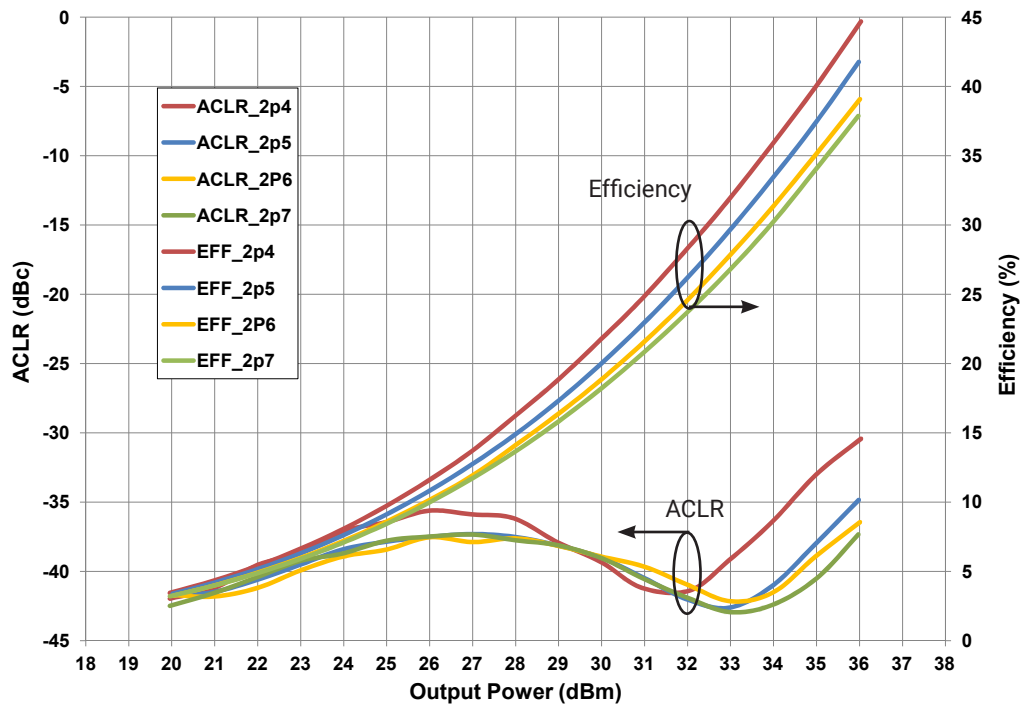
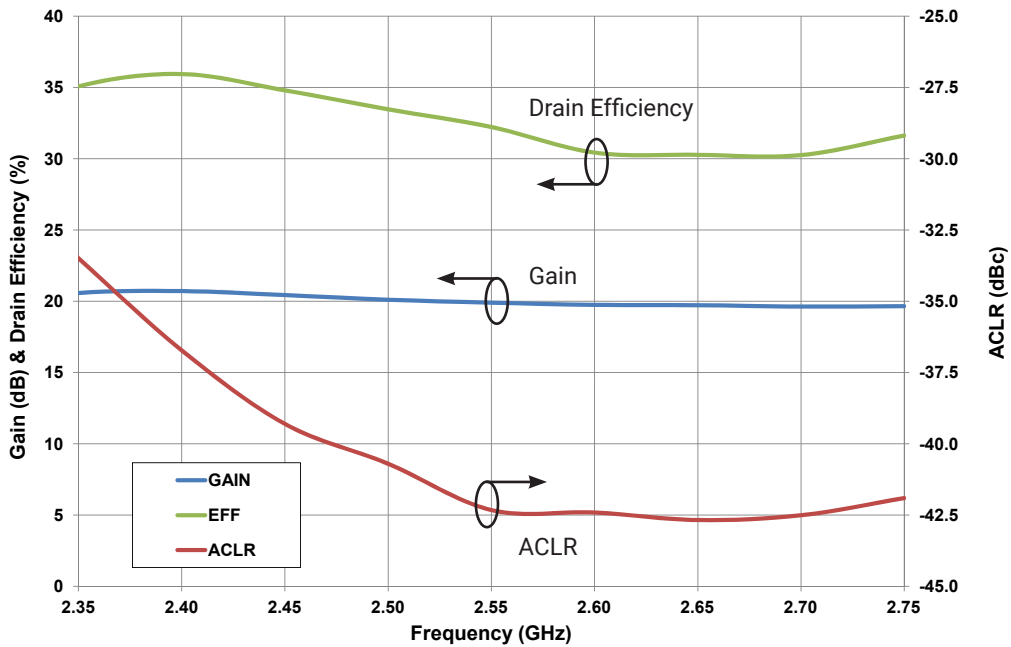

Figure 2. - Typical Drain Efficiency and ACLR vs. Output Power
 $V_{DD} = 50\text{ V}, I_{DQ} = 60\text{ mA}, 1\text{ Carrier WCDMA}, PAR = 7.5\text{ dB}$



Typical Performance in Application Circuit CGHV27015S-AMP1

Figure 3. - Typical Gain, Drain Efficiency and ACLR vs Frequency
 $V_{DD} = 50\text{ V}$, $I_{DQ} = 60\text{ mA}$, $P_{AVE} = 2.5\text{ W}$, 1 Carrier WCDMA, PAR = 7.5 dB



Electrostatic Discharge (ESD) Classifications

Parameter	Symbol	Class	Test Methodology
Human Body Model	HBM	1A (> 250 V)	JEDEC JESD22 A114-D
Charge Device Model	CDM	2 (125 V to 250 V)	JEDEC JESD22 C101-C

Moisture Sensitivity Level (MSL) Classification

Parameter	Symbol	Level	Test Methodology
Moisture Sensitivity Level	MSL	3 (168 hours)	IPC/JEDEC J-STD-20

Typical Performance

G_{MAX} and K-Factor vs Frequency
 $V_{DD} = 50\text{ V}, I_{DQ} = 60\text{ mA}, T_{case} = 25^\circ\text{C}$

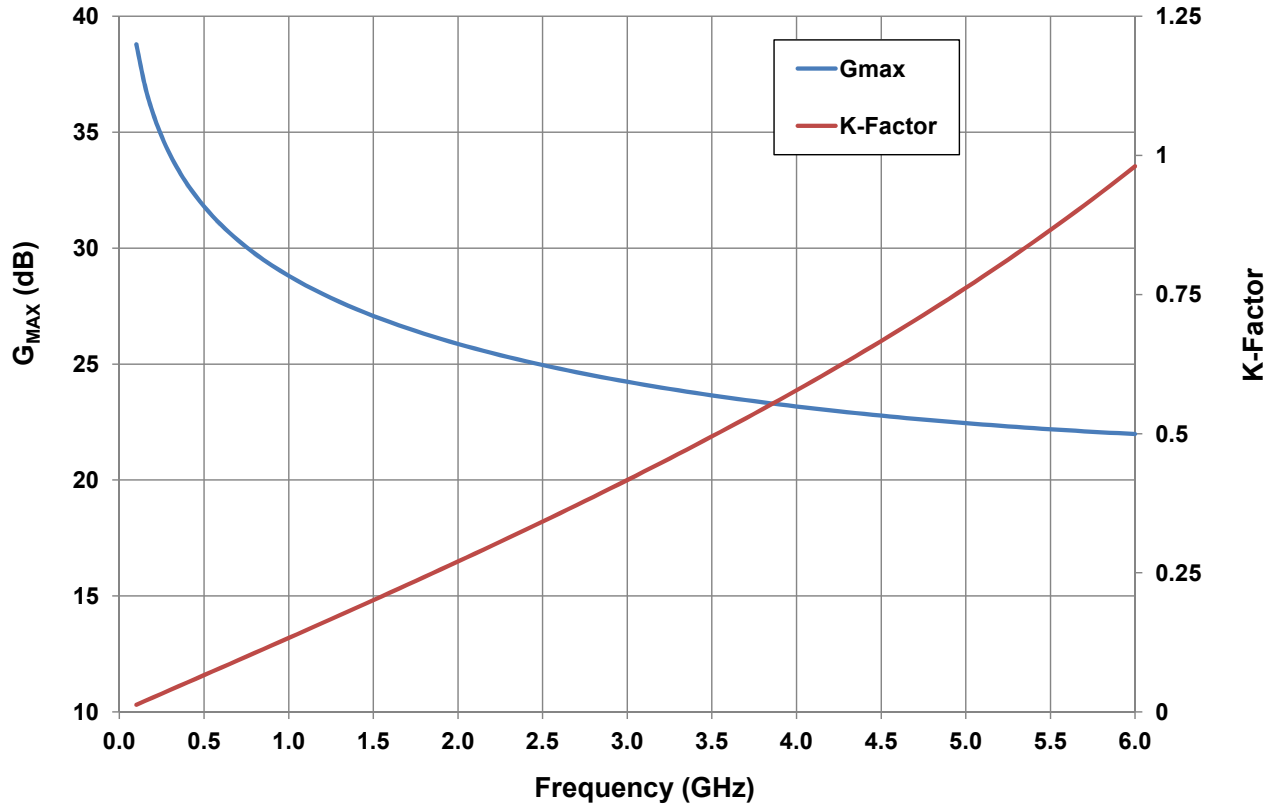

Source and Load Impedances for Application Circuit CGHV27015S-AMP1

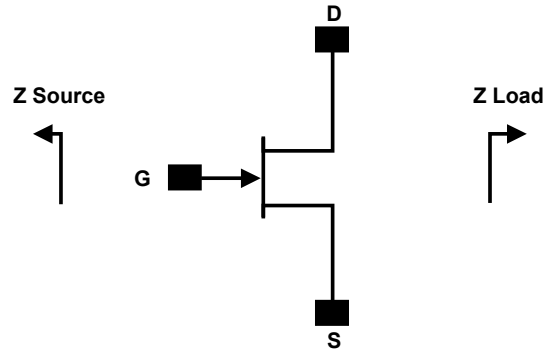

Frequency (MHz)	Z Source	Z Load
2400	$7.9 + j2.14$	$15.8 + j43.1$
2500	$8 + j2.9$	$18.3 + j43.7$
2600	$7.9 + j3.6$	$19.7 + j43.4$
2700	$7.7 - j4.4$	$19.7 + j43.4$

Note¹: $V_{DD} = 50\text{ V}$, $I_{DQ} = 60\text{ mA}$ in the DFN package.

Note²: Impedances are extracted from the CGHV27015S-AMP1 application circuit and are not source and load pull data derived from the transistor.

CGHV27015S-AMP1 Application Circuit Bill of Materials

Designator	Description	Qty
R1	RES, 332,OHM, +/- 1%, Vishay	1
R2	RES, 22.6,OHM, +/- 1%, 1/16W, 0603	1
R3, R4	RES, 2.2,OHM, +/- 1%, 1/16W, 0603	1
C1, C4	CAP, 27pF, +/- 5%, 0603, ATC	2
C2	CAP, 2.0pF,+/-0.1pF, 0603 ATC	1
C3	CAP, 0.1pF,+/-0.05 pF, 0603, ATC	2
C8	CAP, 6.2pF, +/-0.1pF, 0603, ATC	1
C13	CAP, 10pF +/-5%, 0603, ATC	1
C6, C11	CAP, 33000pF, 0805, ATC	2
C7, C12	CAP, 470PF, 5%, 100V, 0603,	2
C10	CAP, 1.0UF, 100V, 10%, X7R, 1210	1
C5	CAP 10UF 16V TANTALUM	1
C9	CAP, 33UF, 20%, G CASE	1
J1, J2	CONN, SMA, PANEL MOUNT JACK, FLANGE, 4-HOLE, BLUNT POST	2
J3	HEADER RT>PLZ .1CEN LK 5POS	1
Q1	CGHV27015S, DFN	1

CGHV27015S-AMP1 Application Circuit, 50 V

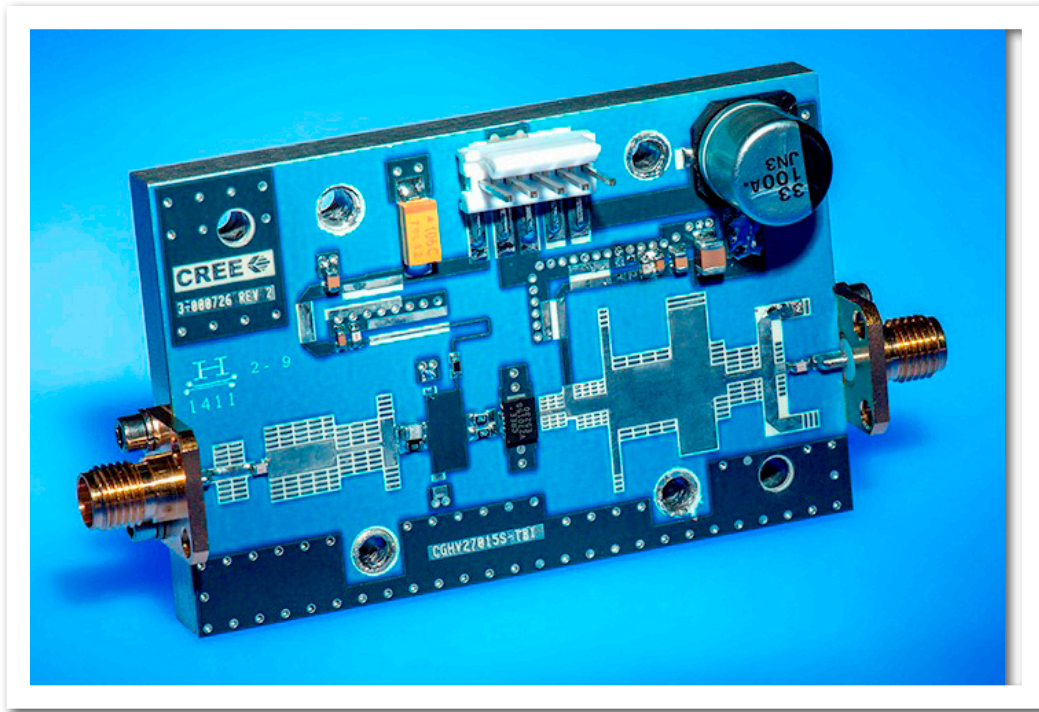

CGHV27015S-AMP1 Application Circuit Schematic, 50 V

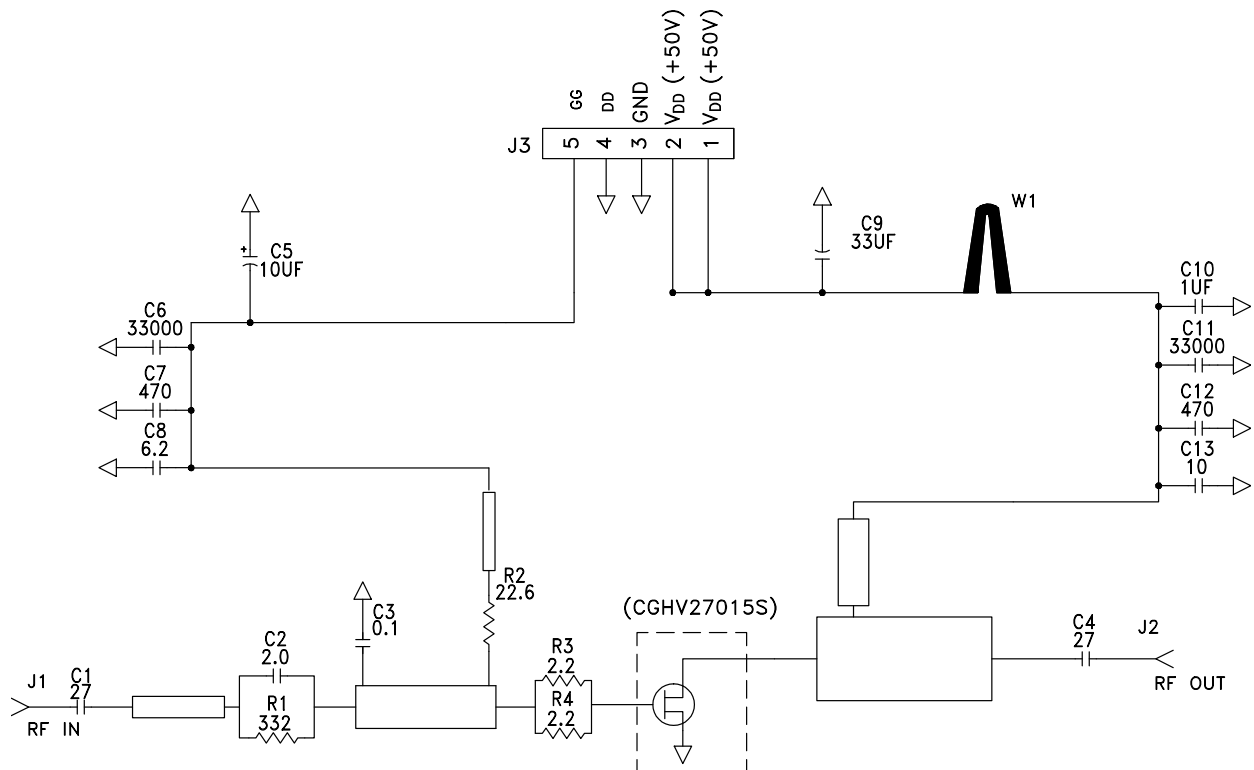

CGHV27015S-AMP1 Application Circuit, 50 V

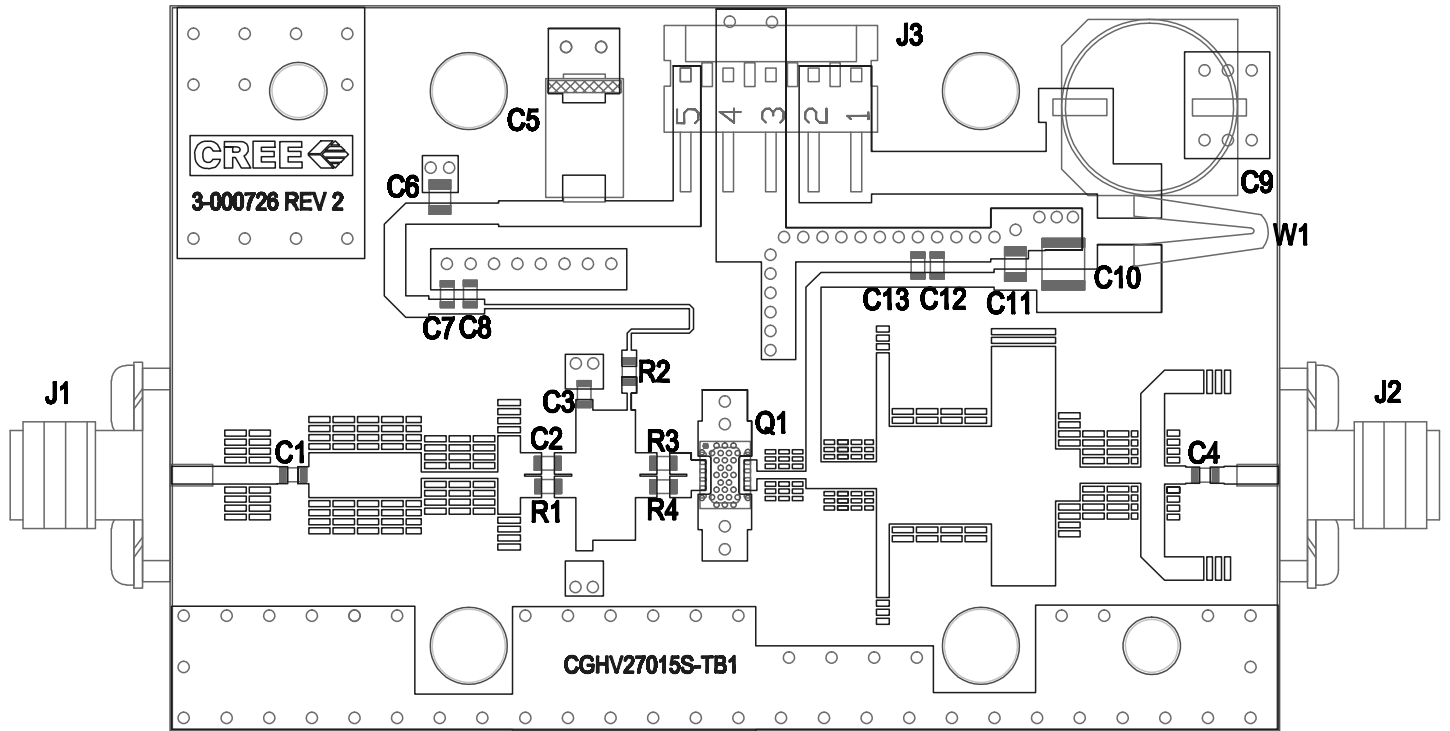

CGHV27015S-AMP1 Power Dissipation De-rating Curve

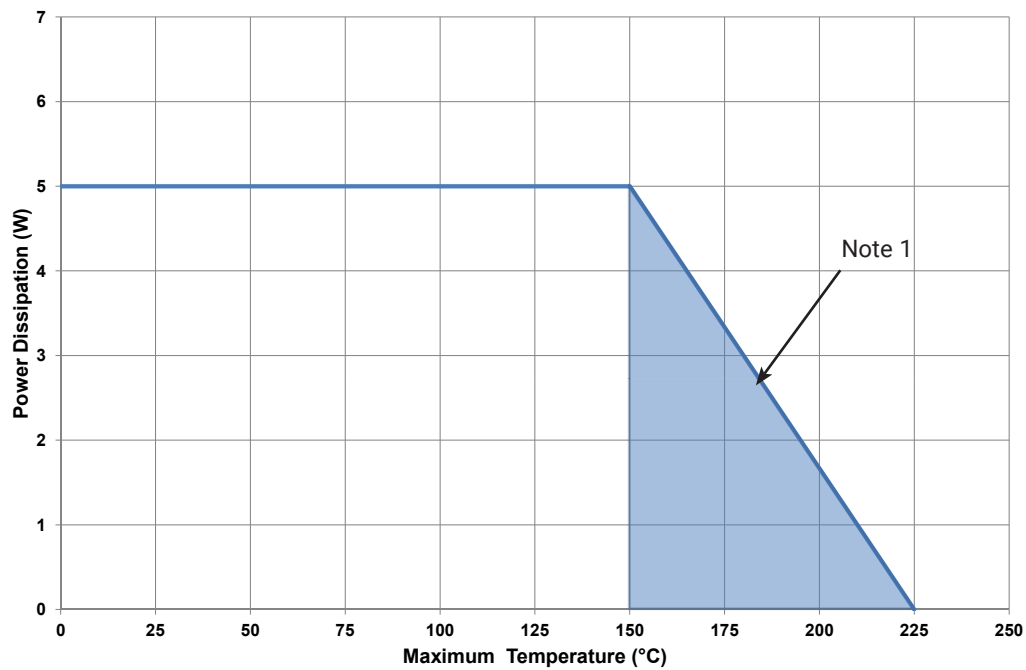

Note 1. Area exceeds Maximum Case Temperature (See Page 2)

Product Dimensions CGHV27015S (Package 3 x 4 DFN)

A3	0.203 REF.			
θ	0	12	2	
D	4.00 BSC			
E	3.00 BSC			
\square	0.50 BSC			
N	12			3
ND	6			\triangle
L	0.35	0.40	0.45	
b	0.17	0.22	0.27	\triangle
D2	3.20	3.30	3.40	
E2	1.60	1.7	1.80	
K	0.20			

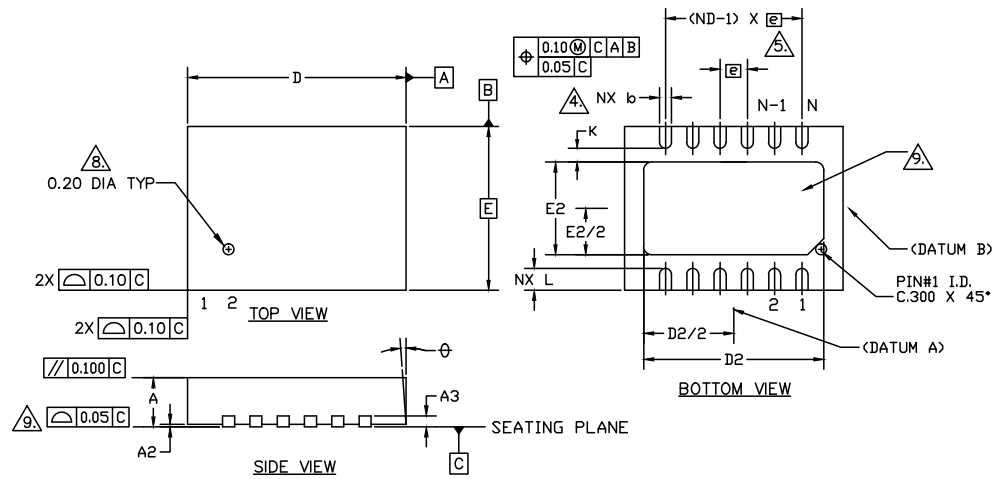

NOTES :

- DIMENSIONING AND TOLERANCING CONFORM TO ASME Y14.5M - 1994.
- ALL DIMENSIONS ARE IN MILLIMETERS, θ IS IN DEGREES.
- N IS THE TOTAL NUMBER OF TERMINALS.
- \triangle DIMENSION b APPLIES TO METALLIZED TERMINAL AND IS MEASURED BETWEEN .15 AND .30mm FROM TERMINAL TIP.
- \triangle ND REFERS TO THE NUMBER OF TERMINALS ON D SIDE
- MAXIMUM PACKAGE WARPAGE IS .05 mm.
- MAXIMUM ALLOWABLE BURRS IS .076 mm IN ALL DIRECTIONS.
- \triangle PIN #1 ID ON TOP WILL BE LASER MARKED.
- \triangle UNILATERAL COPLANARITY ZONE APPLIES TO THE EXPOSED HEAT SINK SLUG AS WELL AS THE TERMINALS.
- THIS DRAWING CONFORMS TO JEDEC REGISTERED OUTLINE MO-229.
- ALL PLATED SURFACES ARE AU.

Pin	Input/Output
1	GND
2	NC
3	RF IN
4	RF IN
5	NC
6	GND
7	GND
8	NC
9	RF OUT
10	RF OUT
11	NC
12	GND

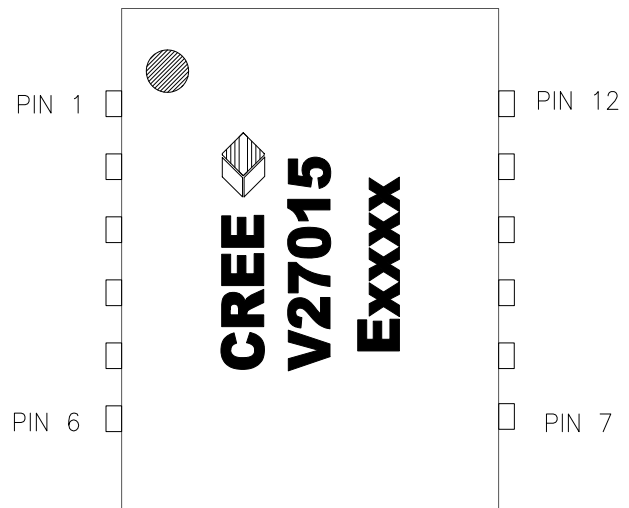

Note: Leadframe finish for 3x4 DFN package is Nickel/Palladium/Gold. Gold is the outer layer.

CGHV27015S

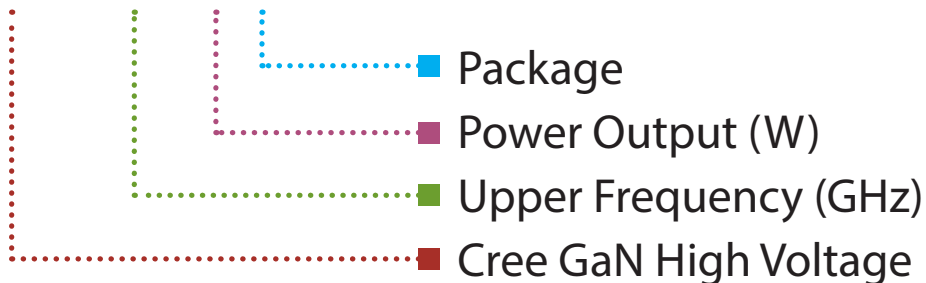

Parameter	Value	Units
Upper Frequency ¹	2.7	GHz
Power Output	15	W
Package	Surface Mount	-

Table 1.

Note¹: Alpha characters used in frequency code indicate a value greater than 9.9 GHz. See Table 2 for value.

Character Code	Code Value
A	0
B	1
C	2
D	3
E	4
F	5
G	6
H	7
J	8
K	9
Examples:	1A = 10.0 GHz 2H = 27.0 GHz

Table 2.

Product Ordering Information

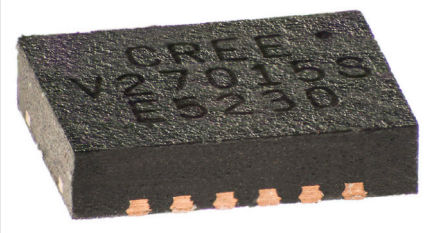
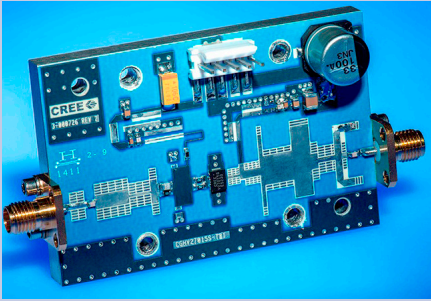
Order Number	Description	Unit of Measure	Image
CGHV27015S	GaN HEMT	Each	
CGHV27015S-AMP1	Test board with GaN HEMT installed	Each	
CGHV27015S-TR	Delivered in Tape and Reel	250 parts / reel	



Disclaimer

Specifications are subject to change without notice. Cree, Inc. believes the information contained within this data sheet to be accurate and reliable. However, no responsibility is assumed by Cree for any infringement of patents or other rights of third parties which may result from its use. No license is granted by implication or otherwise under any patent or patent rights of Cree. Cree makes no warranty, representation or guarantee regarding the suitability of its products for any particular purpose. "Typical" parameters are the average values expected by Cree in large quantities and are provided for information purposes only. These values can and do vary in different applications and actual performance can vary over time. All operating parameters should be validated by customer's technical experts for each application. Cree products are not designed, intended or authorized for use as components in applications intended for surgical implant into the body or to support or sustain life, in applications in which the failure of the Cree product could result in personal injury or death or in applications for planning, construction, maintenance or direct operation of a nuclear facility.

For more information, please contact:

Cree, Inc.
4600 Silicon Drive
Durham, North Carolina, USA 27703
www.cree.com/rf

Sarah Miller
Marketing
Cree, RF Components
1.919.407.5302

Ryan Baker
Marketing & Sales
Cree, RF Components
1.919.407.7816

Tom Dekker
Sales Director
Cree, RF Components
1.919.313.5639



Стандарт Электрон Связь

Мы молодая и активно развивающаяся компания в области поставок электронных компонентов. Мы поставляем электронные компоненты отечественного и импортного производства напрямую от производителей и с крупнейших складов мира.

Благодаря сотрудничеству с мировыми поставщиками мы осуществляем комплексные и плановые поставки широчайшего спектра электронных компонентов.

Собственная эффективная логистика и склад в обеспечивает надежную поставку продукции в точно указанные сроки по всей России.

Мы осуществляем техническую поддержку нашим клиентам и предпродажную проверку качества продукции. На все поставляемые продукты мы предоставляем гарантию .

Осуществляем поставки продукции под контролем ВП МО РФ на предприятия военно-промышленного комплекса России , а также работаем в рамках 275 ФЗ с открытием отдельных счетов в уполномоченном банке. Система менеджмента качества компании соответствует требованиям ГОСТ ISO 9001.

Минимальные сроки поставки, гибкие цены, неограниченный ассортимент и индивидуальный подход к клиентам являются основой для выстраивания долгосрочного и эффективного сотрудничества с предприятиями радиоэлектронной промышленности, предприятиями ВПК и научно-исследовательскими институтами России.

С нами вы становитесь еще успешнее!

Наши контакты:

Телефон: +7 812 627 14 35

Электронная почта: sales@st-electron.ru

Адрес: 198099, Санкт-Петербург,
Промышленная ул, дом № 19, литера Н,
помещение 100-Н Офис 331