

MAX17545 5V Output Evaluation Kit

Evaluates: MAX17545 in 5V Output-Voltage Application

General Description

The MAX17545 5V output evaluation kit (EV kit) provides a proven design to evaluate the MAX17545 high-voltage, high-efficiency, synchronous step-down DC-DC converter. The EV kit is preset for 5V output at load currents up to 1.7A and features a 500kHz switching frequency for optimum efficiency and component size. The EV kit features adjustable input undervoltage lockout, adjustable soft-start, open-drain $\overline{\text{RESET}}$ signal, and external frequency synchronization.

Ordering Information appears at end of data sheet.

Component List

DESIGNATION	QTY	DESCRIPTION
C1	1	2.2 μ F \pm 10%, 50V X7R ceramic capacitor (1210) TDK C3225X7R1H225K
C2	1	2.2 μ F \pm 10%, 10V X7R ceramic capacitor (0603) Murata GRM188R71A225K
C3	1	5600pF \pm 10%, 25V X7R ceramic capacitor (0402) Murata GRM155R71E562K
C4	1	22 μ F \pm 10%, 10V X7R ceramic capacitor (1210) Murata GRM32ER71A226K
C5	1	0.1 μ F \pm 10%, 16V X7R ceramic capacitor (0402) Murata GRM155R71C104K
C6	0	Not installed, ceramic capacitor (0402)
C7	1	47 μ F, 50V aluminum electrolytic capacitor (D = 10mm) Panasonic EEEFK1H470XP
JU1–JU3	3	3-pin headers

Features

- Operates from a 6.5V to 42V Input Supply
- 5V Output Voltage
- Up to 1.7A Output Current
- 500kHz Switching Frequency
- Enable/UVLO Input, Resistor-Programmable UVLO Threshold
- Adjustable Soft-Start Time
- MODE Pin to Select Among PWM, PFM, or DCM Modes
- Open-Drain $\overline{\text{RESET}}$ Output
- External Frequency Synchronization
- Overcurrent and Overtemperature Protection
- Proven PCB Layout
- Fully Assembled and Tested

DESIGNATION	QTY	DESCRIPTION
L1	1	10 μ H inductor Coilcraft XAL6060-103ME Cooper Bussmann MPI4040R4-100-R
R1	1	3.32M Ω \pm 1% resistor (0402)
R2	1	732k Ω \pm 1% resistor (0402)
R3	1	178k Ω \pm 1% resistor (0402)
R4	1	39k Ω \pm 1% resistor (0402)
R5	0	Not installed, resistor (0402)
R6	1	10k Ω \pm 1% resistor (0402)
TP1, TP2	2	Test pads
U1	1	Buck converter (20 TQFN-EP*) Maxim MAX17545ATP+
—	3	Shunts (JU1–JU3)
—	1	PCB: MAX17545 – 5V OUTPUT EVKIT

*EP = Exposed pad.

Note: C7, R1, and R2 are optional components; R1 and R2 are not needed if the EN/UVLO pin is permanently connected to VIN. The electrolytic capacitor (C7) is required only when the VIN power supply is situated far from the MAX17545-based circuit. When R5 is open, the device switches at 500kHz switching frequency. The XAL6060 inductor has been used to prepare the EV kit test report.

Component Suppliers

SUPPLIER	PHONE	WEBSITE
Coilcraft, Inc.	847-639-6400	www.coilcraft.com
CooperBussmann	713-209-8400	www.cooperindustries.com
Murata Americas	800-241-6574	www.murataamericas.com
Panasonic Corp.	800-344-2112	www.panasonic.com
TDK Corp.	516-535-2600	www.tdk.com

Note: Indicate that you are using the MAX17545 when contacting these component suppliers.

Quick Start

Recommended Equipment

- MAX17545 5V output EV kit
- 6.5V to 42V, 4A DC input power supply
- Load capable of sinking 2A
- Digital voltmeter (DVM)

Procedure

The EV kit is fully assembled and tested. Follow the steps below to verify the board operation. **Caution: Do not turn on power supply until all connections are completed.**

- 1) Set the power supply at a voltage between 6.5V and 42V. Disable the power supply.
- 2) Connect the positive terminal of the power supply to the VIN PCB pad and the negative terminal to the nearest PGND PCB pad. Connect the positive terminal of the 1.7A load to the VOUT PCB pad and the negative terminal to the nearest PGND PCB pad.
- 3) Connect the DVM across the VOUT PCB pad and the nearest PGND PCB pad.
- 4) Verify that shunts are installed across pins 1-2 on jumper JU1 and pins 2-3 on jumper JU3 (see [Table 1](#) and [Table 3](#) for details).
- 5) Select the shunt position on jumper JU2 according to the intended mode of operation (see [Table 2](#) for details).
- 6) Turn on the DC power supply.
- 7) Enable the load.
- 8) Verify that the DVM displays 5V.

Detailed Description

The MAX17545 5V output EV kit provides a proven design to evaluate the MAX17545 high-voltage, high-efficiency, synchronous step-down DC-DC converter. The EV kit is preset for 5V output from 6.5V to 42V input at load currents up to 1.7A and features a 500kHz switching frequency for optimum efficiency and component size.

The EV kit includes an EN/UVLO PCB pad and jumper JU1 to enable the output at a desired input voltage. The SYNC PCB pad and jumper JU3 allow an external clock to synchronize the device. Jumper JU2 allows the selection of a particular mode of operation based on light-load performance requirements. An additional $\overline{\text{RESET}}$ PCB pad is available for monitoring whether the converter output is in regulation.

Soft-Start Input (SS)

The device utilizes an adjustable soft-start function to limit inrush current during startup. The soft-start time is adjusted by the value of C3, the external capacitor from SS to GND. The selected output capacitance (C_{SEL}) and the output voltage (V_{OUT}) determine the minimum value of C3, as shown by the following equation:

$$C3 \geq 28 \times 10^{-6} \times C_{\text{SEL}} \times V_{\text{OUT}}$$

The soft-start time (t_{SS}) is related to C3 by the following equation:

$$t_{\text{SS}} = C3 / (5.55 \times 10^{-6})$$

For example, to program a 1ms soft-start time, C3 should be 5.6nF.

Regulator Enable/Undervoltage-Lockout Level (EN/UVLO)

The device offers an adjustable input undervoltage-lockout level. For normal operation, a shunt should be installed across pins 1-2 on jumper JU1. To disable the output, install a shunt across pins 2-3 on JU1 and the EN/UVLO pin is pulled to GND. See [Table 1](#) for JU1 settings.

Set the voltage at which the device turns on with the resistive voltage-divider R1/R2 connected from VIN_ to SGND. Connect the center node of the divider to EN/UVLO.

Choose R1 to be 3.32MΩ and then calculate R2 as follows:

$$R2 = \frac{R1 \times 1.215}{(V_{INU} - 1.215)}$$

where V_{INU} is the voltage at which the device is required to turn on.

MODE Selection (MODE)

The device's MODE pin can be used to select among PWM, PFM, or DCM modes of operation. The logic state of the MODE pin is latched when VCC and EN/UVLO voltages exceed the respective UVLO rising thresholds and all internal voltages are ready to allow LX switching. State changes on the MODE pin are ignored during normal

Table 1. Regulator Enable (EN/UVLO) Description (JU1)

SHUNT POSITION	EN/UVLO PIN	MAX17545_ OUTPUT
1-2*	Connected to VIN	Enabled
Not installed	Connected to the center node of resistor-divider R1 and R2	Enabled, UVLO level set through the R1 and R2 resistors
2-3	Connected to SGND	Disabled

*Default position.

operation. Refer to the MAX17545 IC data sheet for more information on PWM, PFM, and DCM modes of operation.

[Table 2](#) shows EV kit jumper settings that can be used to configure the desired mode of operation.

External Clock Synchronization (SYNC)

The internal oscillator of the device can be synchronized to an external clock signal on the SYNC pin. The external synchronization clock frequency must be between 1.1f_{SW} and 1.4f_{SW}, where f_{SW} is the frequency of operation set by R5. The minimum external clock high pulse width should be greater than 50ns and the minimum external clock low pulse width should be greater than 160ns.

Table 2. MODE Description (JU2)

SHUNT POSITION	MODE PIN	MAX17545_ MODE
Not installed*	Unconnected	PFM mode of operation
1-2	Connected to SGND	PWM mode of operation
2-3	Connected to VCC	DCM mode of operation

*Default position.

Table 3. SYNC Description (JU3)

SHUNT POSITION	SYNC PIN	MAX17545_ SYNC
1-2	Connected to test loop on PCB	Frequency can be synchronized with an external clock
2-3*	Connected to SGND	SYNC feature unused

*Default position.

EV Kit Test Report

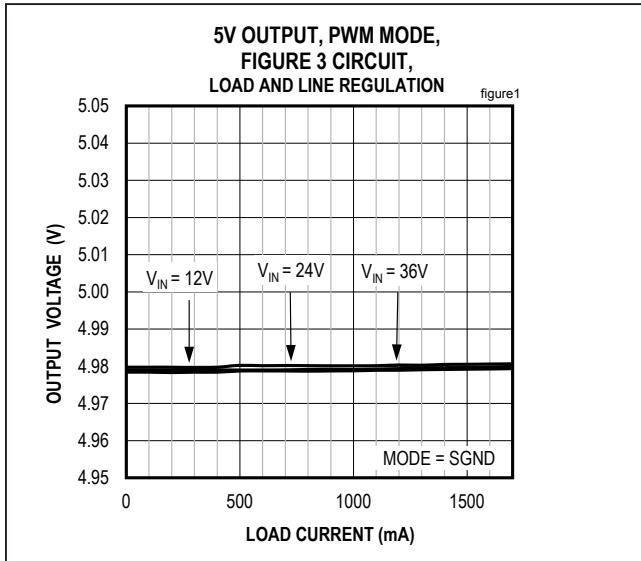

Figure 1. MAX17545 5V Output Load and Line Regulation (PWM Mode)

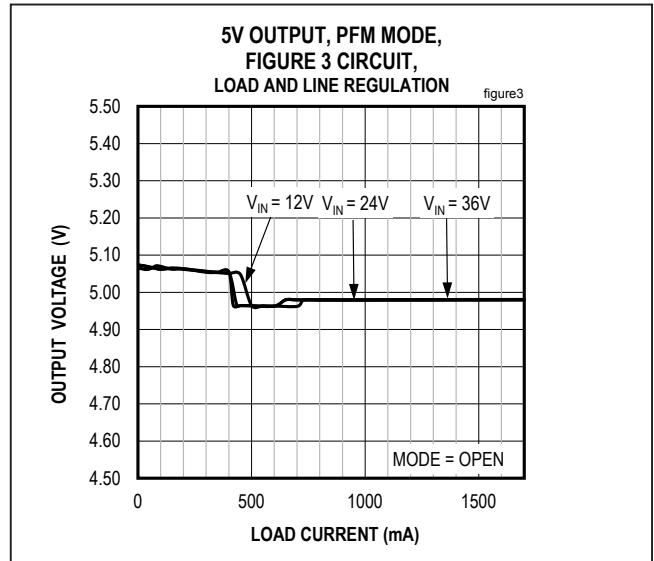

Figure 3. MAX17545 5V Output Load and Line Regulation (PFM Mode)

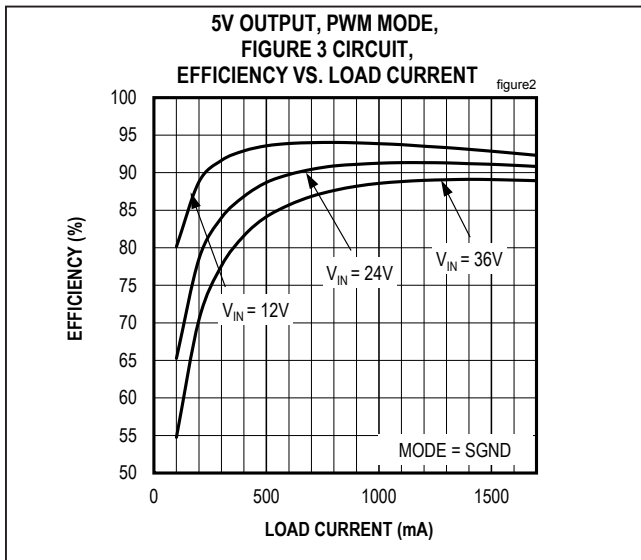

Figure 2. MAX17545 5V Output Efficiency (PWM Mode)

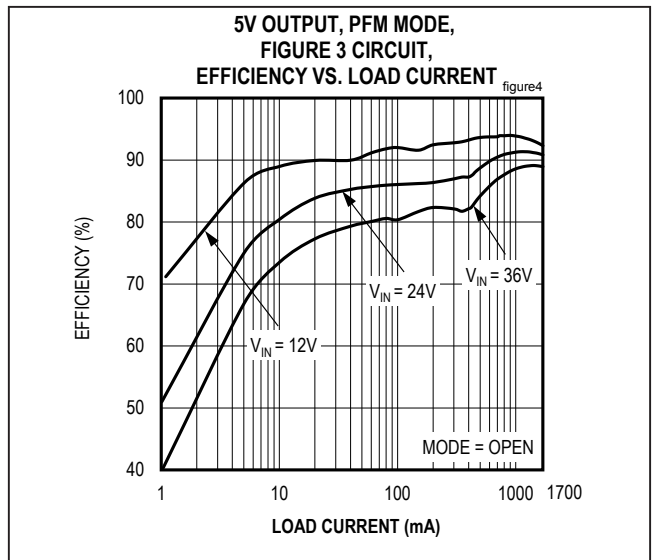

Figure 4. MAX17545 5V Output Efficiency (PFM Mode)

EV Kit Test Report (continued)

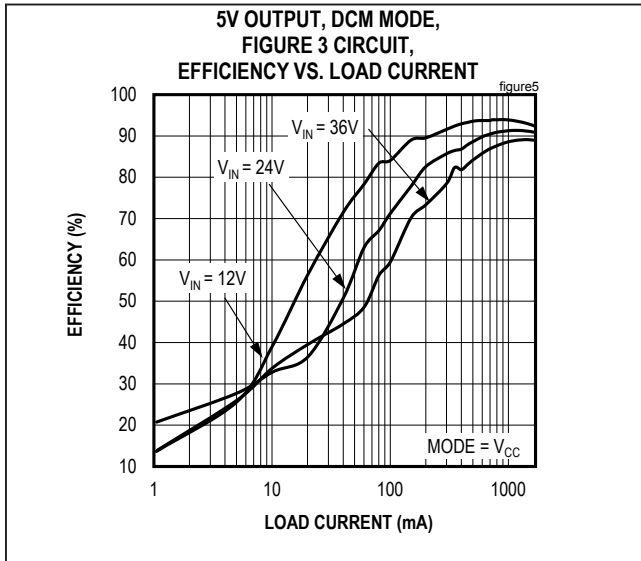

Figure 5. MAX17545 5V Output Efficiency (DCM Mode)

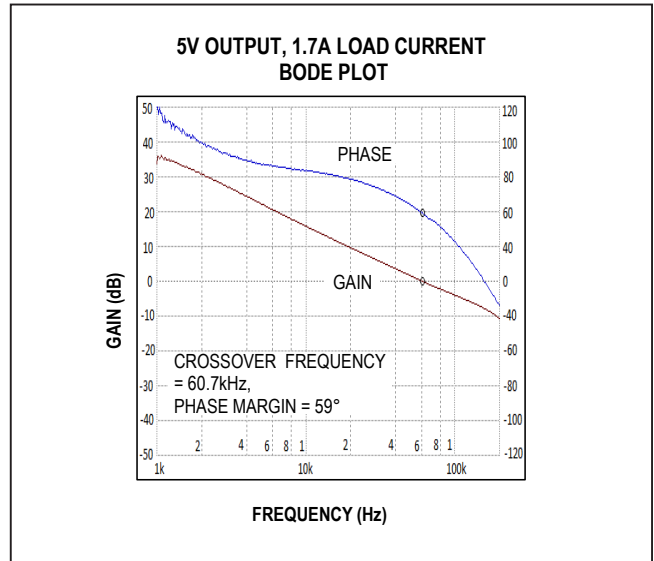

Figure 6. MAX17545 5V Output Full Load Bode Plot ($V_{IN} = 24V$)

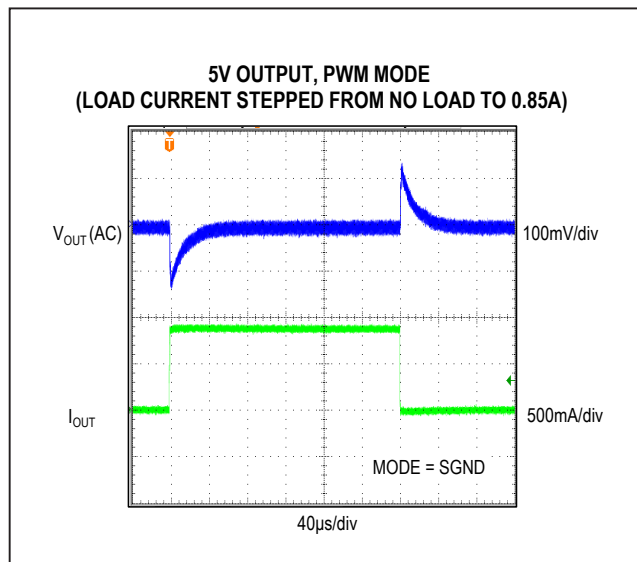

Figure 7. MAX17545 5V Output, No Load to 0.85A Load Transient (PWM Mode)

EV Kit Test Report (continued)

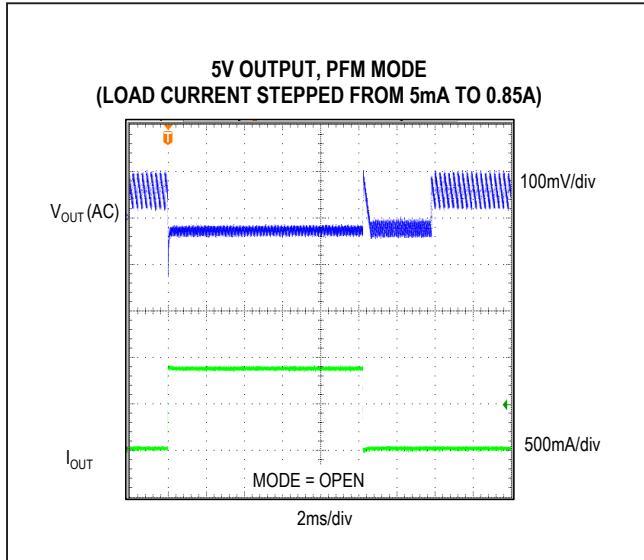

Figure 8. MAX17545 5V Output, 5mA to 0.85A Load Transient (PFM Mode)

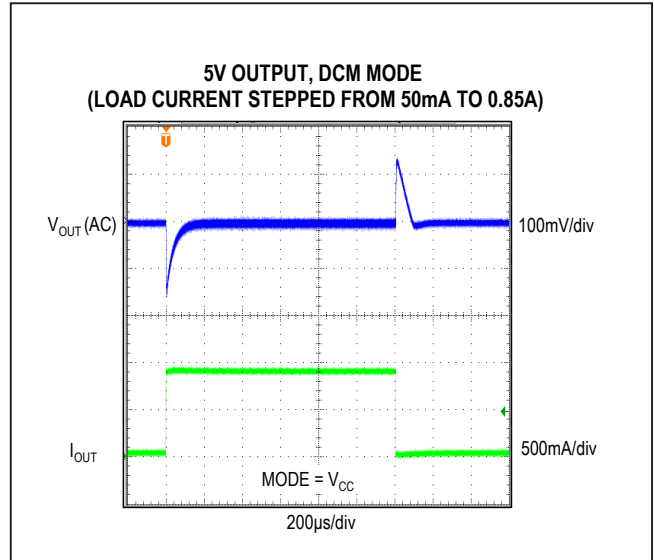

Figure 9. MAX17545 5V Output, 50mA to 0.85A Load Transient (DCM Mode)

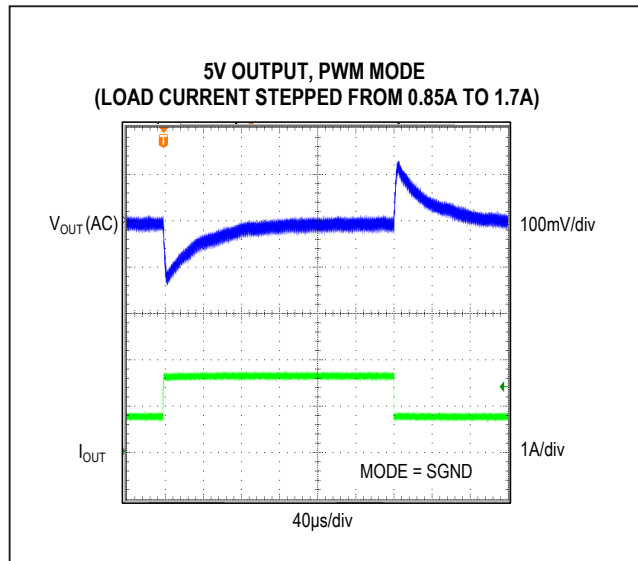

Figure 10. MAX17545 5V Output, 0.85A to 1.7A Load Transient

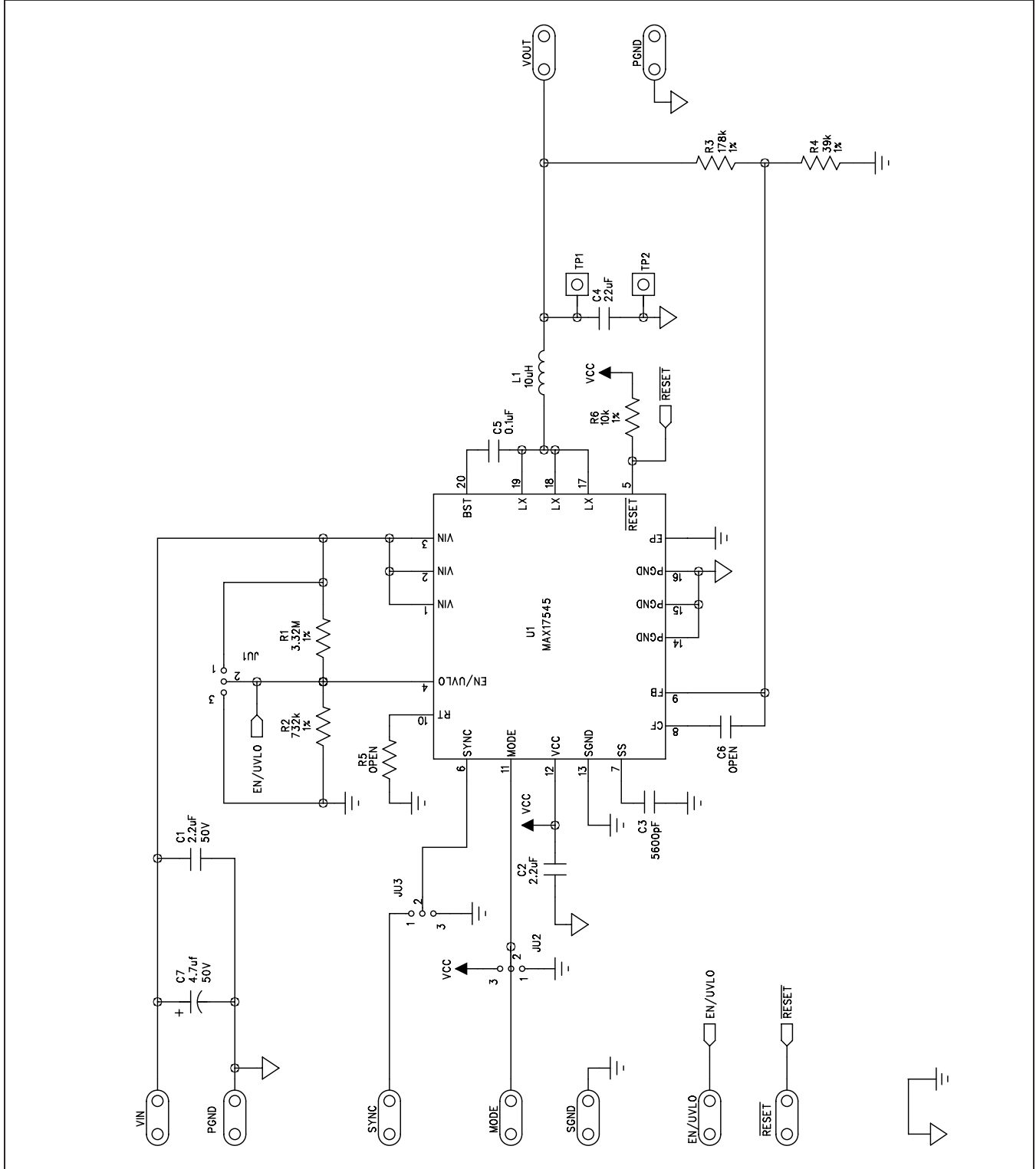

Figure 11. MAX17545 5V Output EV Kit Schematic

MAX17545 5V Output Evaluation Kit

Evaluates: MAX17545 in 5V Output-Voltage Application

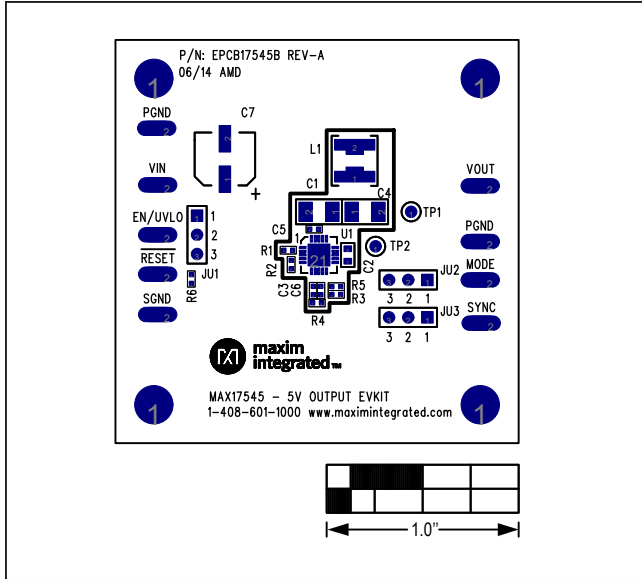

Figure 12. MAX17545 5V Output EV Kit Component Placement Guide—Component Side

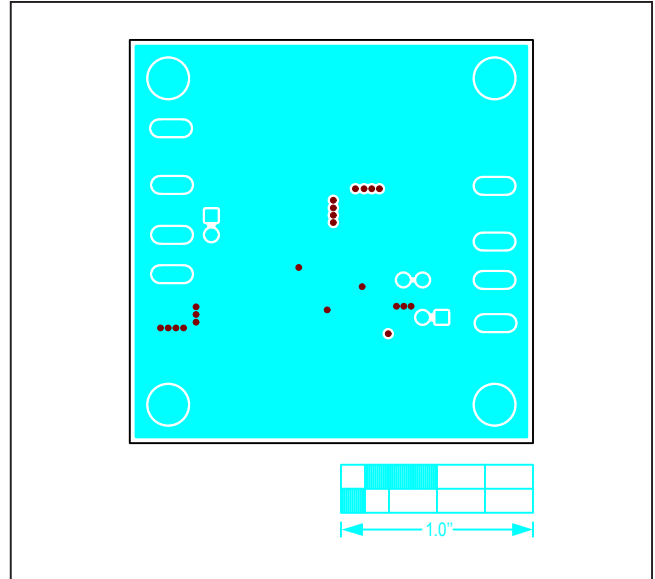

Figure 14. MAX17545 5V Output EV Kit PCB Layout—Inner Layer 1

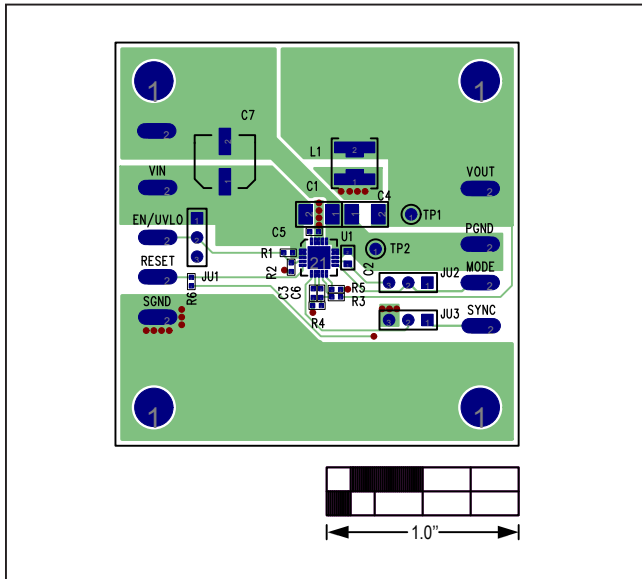

Figure 13. MAX17545 5V Output EV Kit Component Side PCB layout

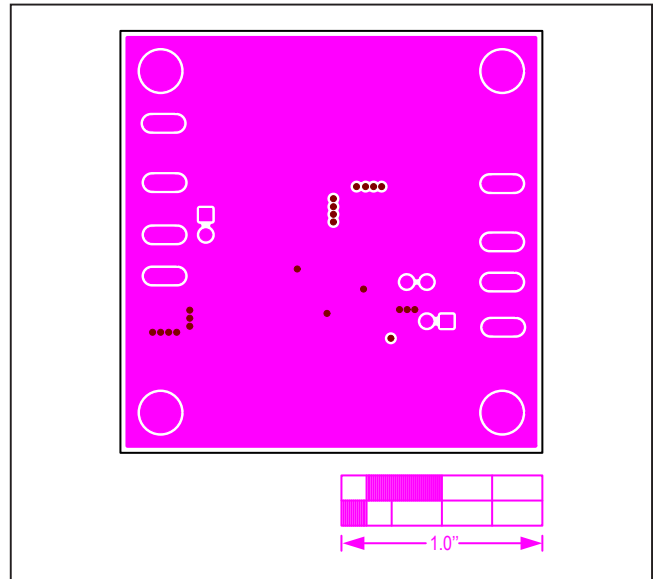

Figure 15. MAX17545 5V Output EV Kit PCB Layout—Inner Layer 2

MAX17545 5V Output Evaluation Kit

Evaluates: MAX17545 in 5V Output-Voltage Application

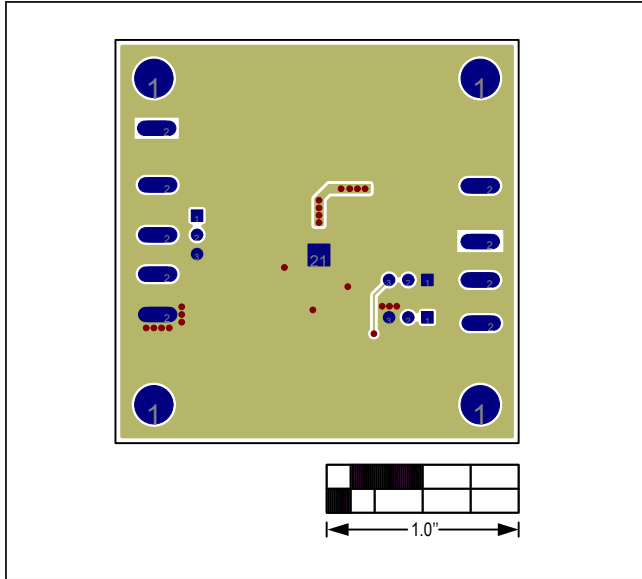

Figure 16. MAX17545 5V Output EV Kit PCB Layout—Solder Side

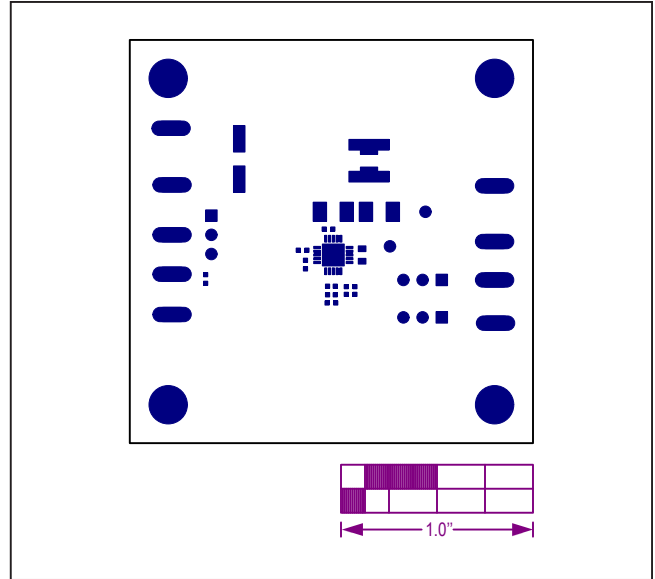

Figure 17. MAX17545 5V Output EV Kit Component Placement Guide—Top Solder Mask

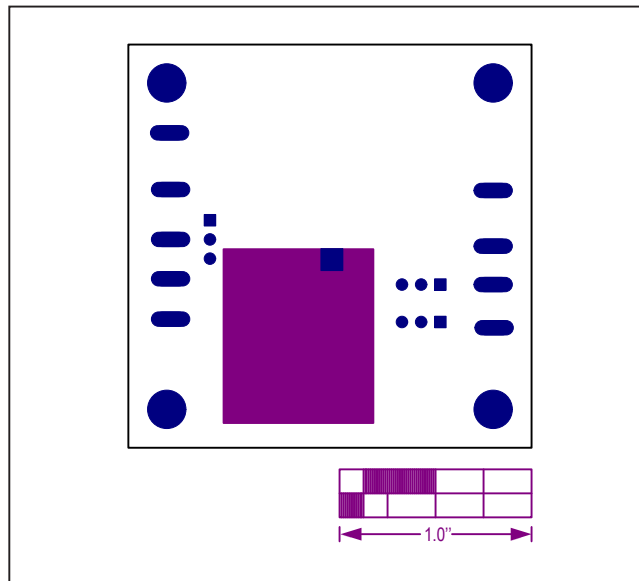

Figure 18. MAX17545 5V Output EV Kit Component Placement Guide—Bottom Solder Mask

MAX17545 5V Output Evaluation Kit

Evaluates: MAX17545 in
5V Output-Voltage Application

Ordering Information

PART	TYPE
MAX17545EVKITB#	EV Kit

#Denotes RoHS compliant.

Revision History

REVISION NUMBER	REVISION DATE	DESCRIPTION	PAGES CHANGED
0	10/14	Initial release	—

For pricing, delivery, and ordering information, please contact Maxim Direct at 1-888-629-4642, or visit Maxim Integrated's website at www.maximintegrated.com.

Maxim Integrated cannot assume responsibility for use of any circuitry other than circuitry entirely embodied in a Maxim Integrated product. No circuit patent licenses are implied. Maxim Integrated reserves the right to change the circuitry and specifications without notice at any time.



Стандарт Электрон Связь

Мы молодая и активно развивающаяся компания в области поставок электронных компонентов. Мы поставляем электронные компоненты отечественного и импортного производства напрямую от производителей и с крупнейших складов мира.

Благодаря сотрудничеству с мировыми поставщиками мы осуществляем комплексные и плановые поставки широчайшего спектра электронных компонентов.

Собственная эффективная логистика и склад в обеспечивает надежную поставку продукции в точно указанные сроки по всей России.

Мы осуществляем техническую поддержку нашим клиентам и предпродажную проверку качества продукции. На все поставляемые продукты мы предоставляем гарантию .

Осуществляем поставки продукции под контролем ВП МО РФ на предприятия военно-промышленного комплекса России , а также работаем в рамках 275 ФЗ с открытием отдельных счетов в уполномоченном банке. Система менеджмента качества компании соответствует требованиям ГОСТ ISO 9001.

Минимальные сроки поставки, гибкие цены, неограниченный ассортимент и индивидуальный подход к клиентам являются основой для выстраивания долгосрочного и эффективного сотрудничества с предприятиями радиоэлектронной промышленности, предприятиями ВПК и научно-исследовательскими институтами России.

С нами вы становитесь еще успешнее!

Наши контакты:

Телефон: +7 812 627 14 35

Электронная почта: sales@st-electron.ru

Адрес: 198099, Санкт-Петербург,
Промышленная ул, дом № 19, литера Н,
помещение 100-Н Офис 331