

Analog Devices Welcomes Hittite Microwave Corporation

NO CONTENT ON THE ATTACHED DOCUMENT HAS CHANGED



THIS PAGE INTENTIONALLY LEFT BLANK

GaAs PHEMT MMIC 2 WATT POWER AMPLIFIER, 6 - 10 GHz

Typical Applications

The HMC591 is ideal for use as a power amplifier for:

- Point-to-Point Radios
- Point-to-Multi-Point Radios
- Test Equipment & Sensors
- Military End-Use
- Space

Features

- Saturated Output Power: +34 dBm @ 24% PAE
- Output IP3: +43 dBm
- Gain: 23 dB
- DC Supply: +7.0 V @ 1340 mA
- 50 Ohm Matched Input/Output
- 2.47 mm x 2.49 mm x 0.1 mm

Functional Diagram

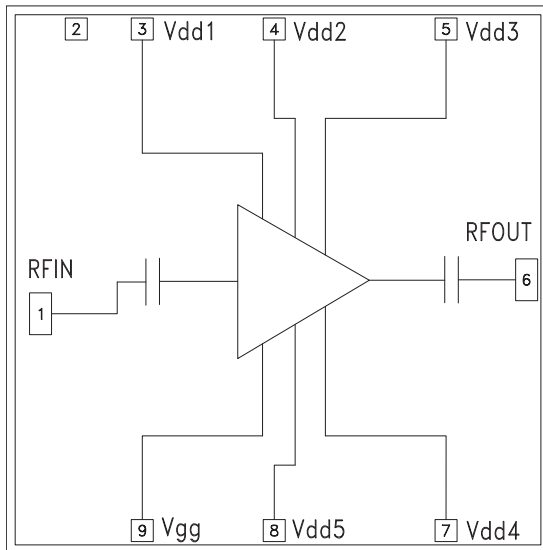

General Description

The HMC591 is a high dynamic range GaAs PHEMT MMIC 2 Watt Power Amplifier which operates from 6 to 10 GHz. This amplifier die provides 23 dB of gain and +34 dBm of saturated power, at 24% PAE from a +7.0V supply. Output IP3 is +43 dBm typical. The RF I/Os are DC blocked and matched to 50 Ohms for ease of integration into Multi-Chip-Modules (MCMs). All data is taken with the chip in a 50 ohm test fixture connected via 0.025mm (1 mil) diameter wire bonds of length 0.31mm (12 mils). For applications which require optimum OIP3, I_{dd} should be set for 940 mA, to yield +43 dBm OIP3. For applications which require optimum output P1dB, I_{dd} should be set for 1340 mA, to yield +33 dBm Output P1dB.

Electrical Specifications, $T_A = +25^\circ\text{C}$, $V_{dd} = +7\text{V}$, $I_{dd} = 1340\text{mA}$ ^[1]

Parameter	Min.	Typ.	Max.	Min.	Typ.	Max.	Units
Frequency Range	6 - 10			6.8 - 9			GHz
Gain	20	23		20	23		dB
Gain Variation Over Temperature		0.05			0.05		dB/ °C
Input Return Loss		12			14		dB
Output Return Loss		11			10		dB
Output Power for 1 dB Compression (P1dB)	30	33		30.5	33.5		dBm
Saturated Output Power (Psat)		33.5			34		dBm
Output Third Order Intercept (IP3) ^[2]		43			43		dBm
Supply Current (I _{dd})		1340			1340		mA

[1] Adjust V_{gg} between -2 to 0V to achieve I_{dd}= 1340 mA typical.

[2] Measurement taken at 7V @ 940mA, Pin / Tone = -15 dBm

**GaAs PHEMT MMIC 2 WATT
POWER AMPLIFIER, 6 - 10 GHz**

Broadband Gain & Return Loss

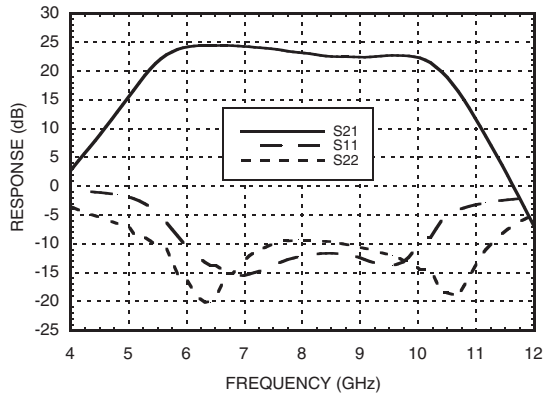

Gain vs. Temperature

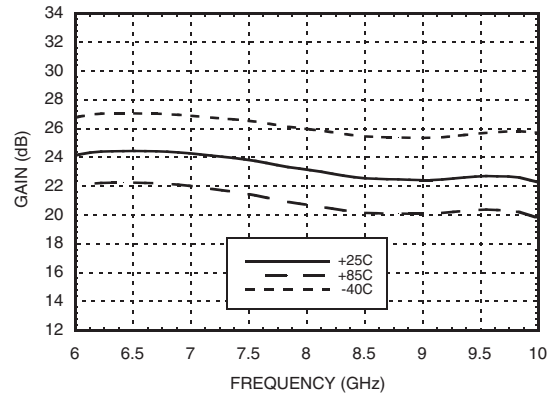

Input Return Loss vs. Temperature

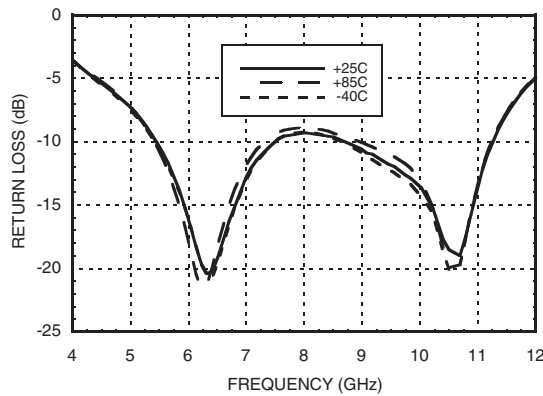

Output Return Loss vs. Temperature

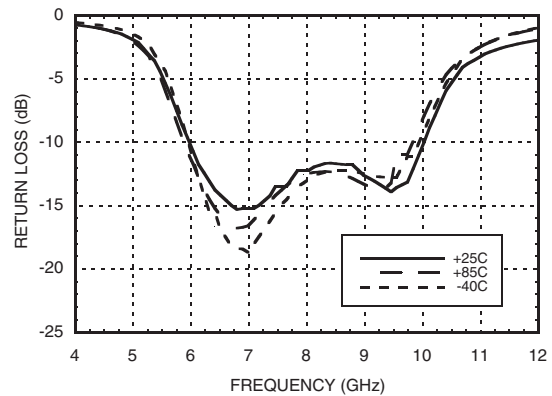

P1dB vs. Temperature

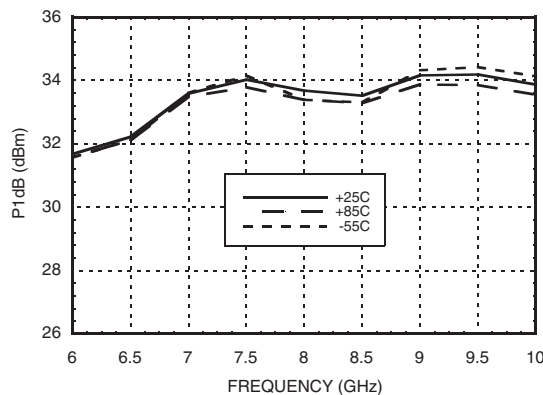

Psat vs. Temperature

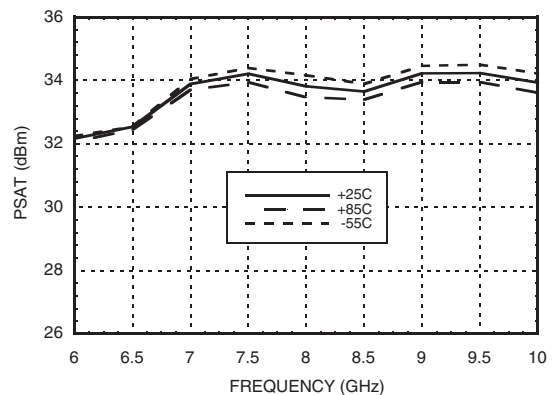

**GaAs PHEMT MMIC 2 WATT
POWER AMPLIFIER, 6 - 10 GHz**

P1dB vs. Current

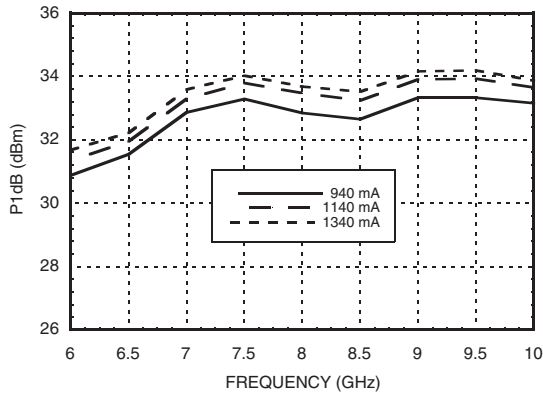

Psat vs. Current

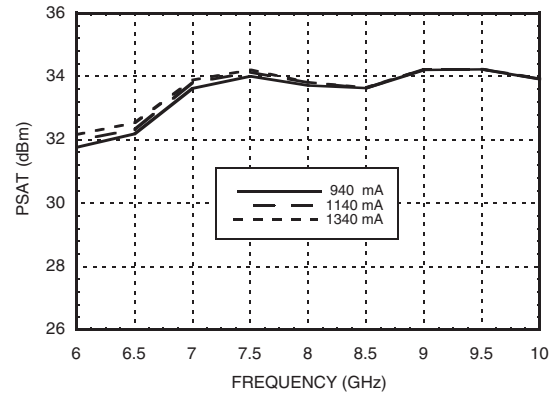

**Output IP3 vs. Temperature
7V @ 940 mA, Pin/Tone = -15 dBm**

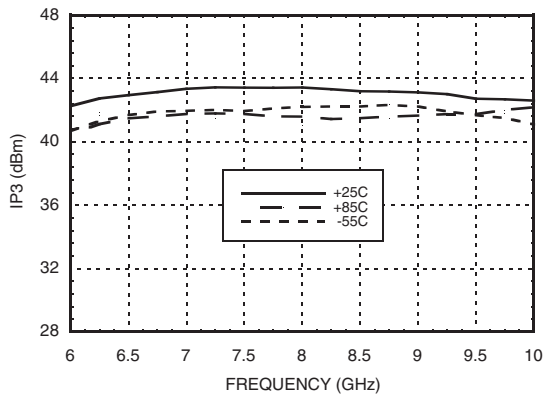

**Power Compression @ 8 GHz,
7V @ 1340 mA**

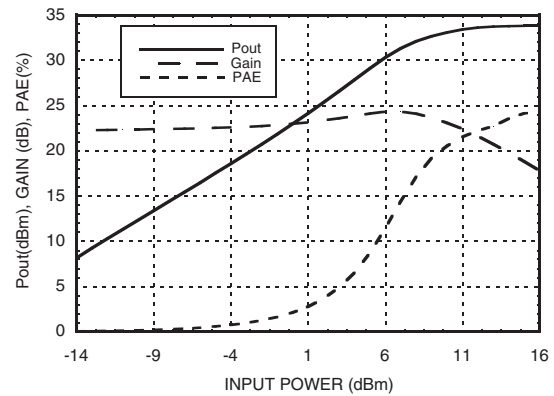

Output IM3, 7V @ 940 mA

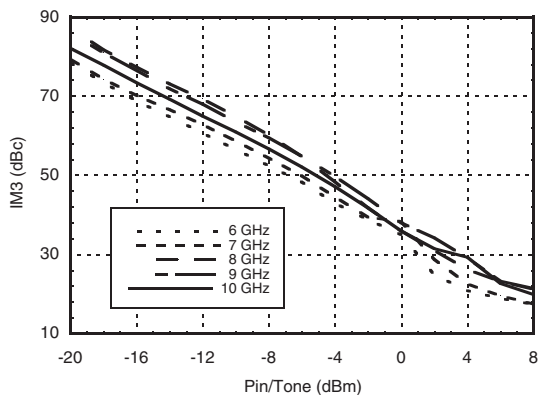

Output IM3, 7V @ 1340 mA

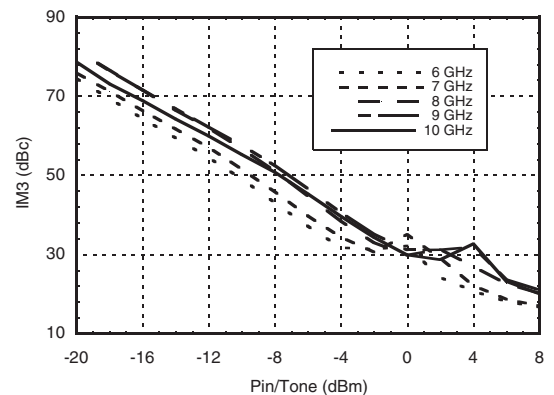

**GaAs PHEMT MMIC 2 WATT
POWER AMPLIFIER, 6 - 10 GHz**

Gain & Power vs. Supply Voltage @ 8 GHz

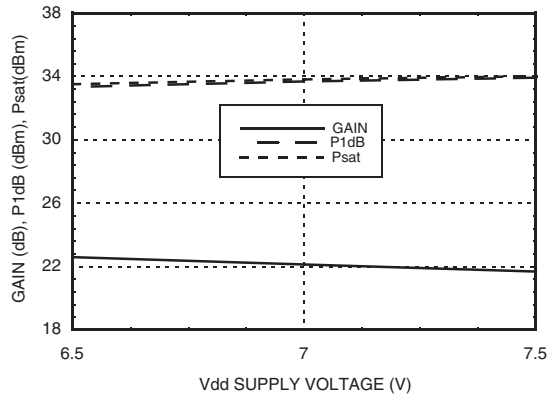

Gain & Power vs. Supply Current @ 8 GHz

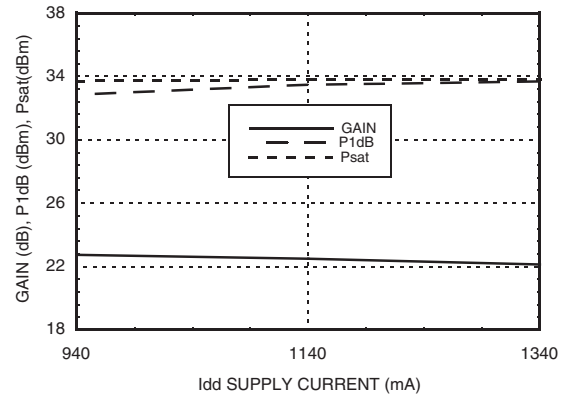

**Reverse Isolation
vs. Temperature, 7V @ 1340 mA**

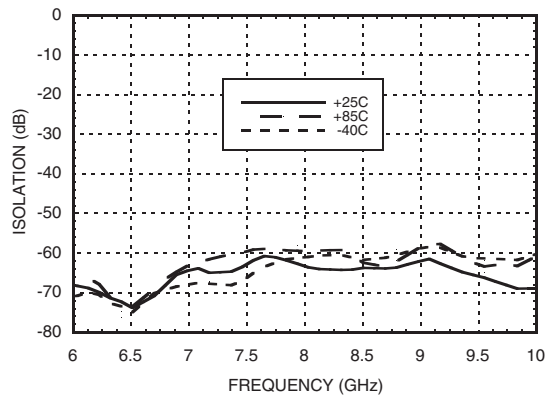

Power Dissipation

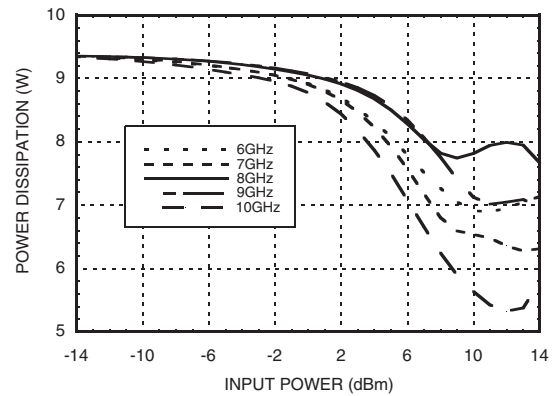

Absolute Maximum Ratings

Drain Bias Voltage (Vdd)	+8 Vdc
Gate Bias Voltage (Vgg)	-2 to 0 Vdc
RF Input Power (RFIN)(Vdd = +7.0 Vdc)	+15 dBm
Channel Temperature	175 °C
Continuous Pdiss (T= 85 °C) (derate 117.6 mW/°C above 85 °C)	10.59 W
Thermal Resistance (channel to die bottom)	8.5 °C/W
Storage Temperature	-65 to +150 °C
Operating Temperature	-55 to +85 °C

Typical Supply Current vs. Vdd

Vdd (V)	Idd (mA)
+6.5	1355
+7.0	1340
+7.5	1325

Note: Amplifier will operate over full voltage ranges shown above Vgg adjusted to achieve Idd = 1340 mA at +7.0V



**ELECTROSTATIC SENSITIVE DEVICE
OBSERVE HANDLING PRECAUTIONS**

GaAs PHEMT MMIC 2 WATT POWER AMPLIFIER, 6 - 10 GHz

Outline Drawing

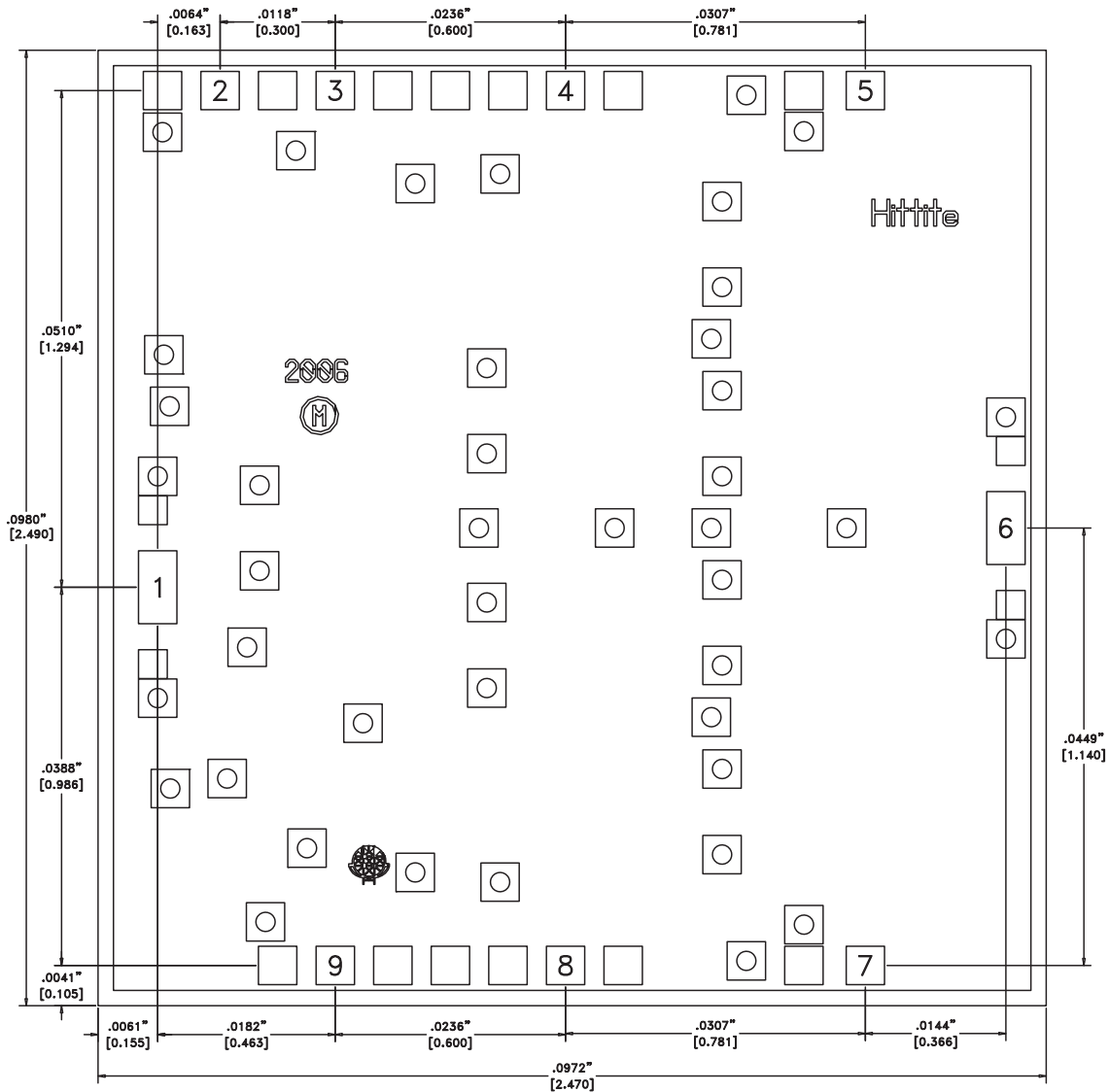

Die Packaging Information [1]

Standard	Alternate
GP-1 (Gel Pack)	[2]

[1] Refer to the "Packaging Information" section for die packaging dimensions.



[2] For alternate packaging information contact Hittite Microwave Corporation.

NOTES:

1. ALL DIMENSIONS ARE IN INCHES [MM]
2. DIE THICKNESS IS .004"
3. TYPICAL BOND PAD IS .004" SQUARE
4. BACKSIDE METALLIZATION: GOLD
5. BOND PAD METALLIZATION: GOLD
6. BACKSIDE METAL IS GROUND.
7. CONNECTION NOT REQUIRED FOR UNLABELED BOND PADS.
8. OVERALL DIE SIZE ± .002

GaAs PHEMT MMIC 2 WATT POWER AMPLIFIER, 6 - 10 GHz

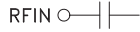
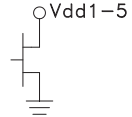
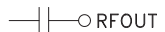
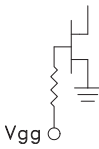
Pad Descriptions

Pad Number	Function	Description	Interface Schematic
1	RFIN	This pad is AC coupled and matched to 50 Ohms.	
3 - 5, 7, 8	Vdd 1-5	Power Supply Voltage for the amplifier. External bypass capacitors of 100 pF and 0.1 μF are required.	
6	RFOUT	This pad is AC coupled and matched to 50 Ohms.	
9	Vgg	Gate control for amplifier. Adjust to achieve I _{dd} of 1340 mA. Please follow "MMIC Amplifier Biasing Procedure" Application Note. External bypass capacitors of 100 pF and 0.1 μF are required.	
Die Bottom	GND	Die bottom must be connected to RF/DC ground.	

**GaAs PHEMT MMIC 2 WATT
POWER AMPLIFIER, 6 - 10 GHz**

Assembly Diagram

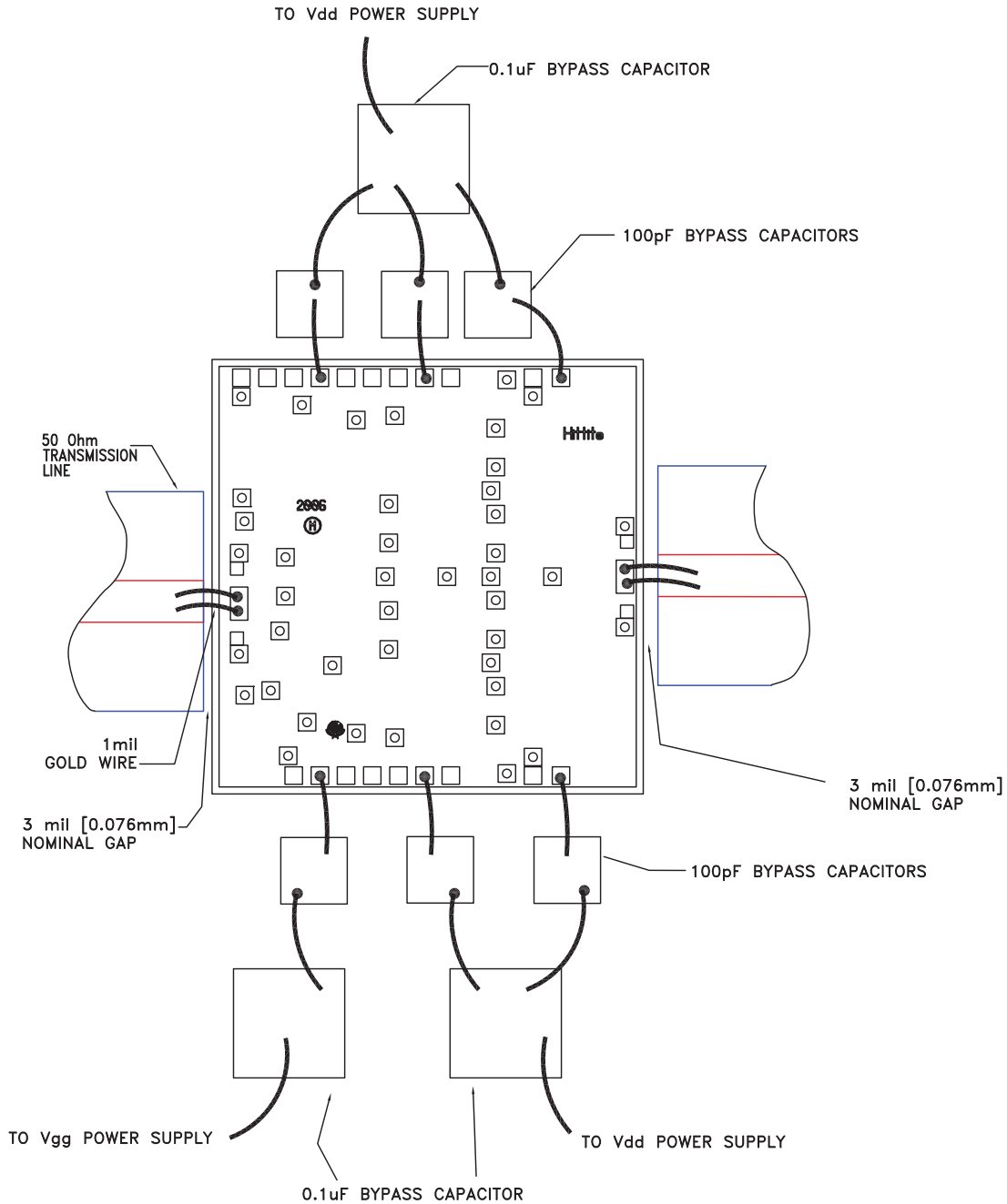

**GaAs PHEMT MMIC 2 WATT
POWER AMPLIFIER, 6 - 10 GHz**

Mounting & Bonding Techniques for Millimeterwave GaAs MMICs

The die should be attached directly to the ground plane eutectically or with conductive epoxy (see HMC general Handling, Mounting, Bonding Note).

50 Ohm Microstrip transmission lines on 0.127mm (5 mil) thick alumina thin film substrates are recommended for bringing RF to and from the chip (Figure 1). If 0.254mm (10 mil) thick alumina thin film substrates must be used, the die should be raised 0.150mm (6 mils) so that the surface of the die is coplanar with the surface of the substrate. One way to accomplish this is to attach the 0.102mm (4 mil) thick die to a 0.150mm (6 mil) thick molybdenum heat spreader (moly-tab) which is then attached to the ground plane (Figure 2).

Microstrip substrates should be located as close to the die as possible in order to minimize bond wire length. Typical die-to-substrate spacing is 0.076mm to 0.152 mm (3 to 6 mils).

Handling Precautions

Follow these precautions to avoid permanent damage.

Storage: All bare die are placed in either Waffle or Gel based ESD protective containers, and then sealed in an ESD protective bag for shipment. Once the sealed ESD protective bag has been opened, all die should be stored in a dry nitrogen environment.

Cleanliness: Handle the chips in a clean environment. DO NOT attempt to clean the chip using liquid cleaning systems.

Static Sensitivity: Follow ESD precautions to protect against > ± 250V ESD strikes.

Transients: Suppress instrument and bias supply transients while bias is applied. Use shielded signal and bias cables to minimize inductive pick-up.

General Handling: Handle the chip along the edges with a vacuum collet or with a sharp pair of bent tweezers. The surface of the chip may have fragile air bridges and should not be touched with vacuum collet, tweezers, or fingers.

Mounting

The chip is back-metallized and can be die mounted with electrically conductive epoxy. The mounting surface should be clean and flat.

Epoxy Die Attach: Apply a minimum amount of epoxy to the mounting surface so that a thin epoxy fillet is observed around the perimeter of the chip once it is placed into position. Cure epoxy per the manufacturer's schedule.

Wire Bonding

Ball or wedge bond with 0.025mm (1 mil) diameter pure gold wire. Thermosonic wirebonding with a nominal stage temperature of 150 °C and a ball bonding force of 40 to 50 grams or wedge bonding force of 18 to 22 grams is recommended. Use the minimum level of ultrasonic energy to achieve reliable wirebonds. Wirebonds should be started on the chip and terminated on the package or substrate. All bonds should be as short as possible <0.31mm (12 mils).

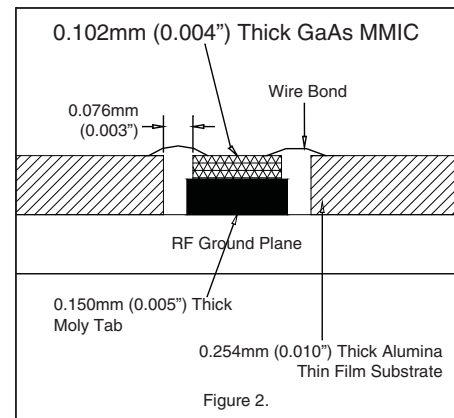
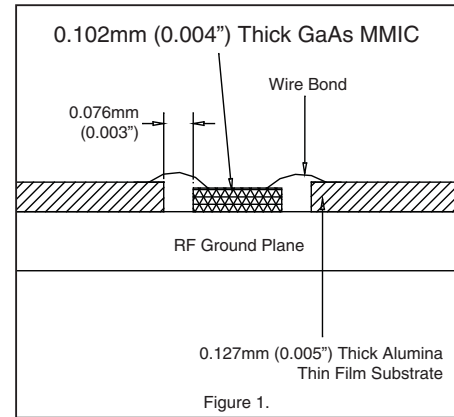



Стандарт Электрон Связь

Мы молодая и активно развивающаяся компания в области поставок электронных компонентов. Мы поставляем электронные компоненты отечественного и импортного производства напрямую от производителей и с крупнейших складов мира.

Благодаря сотрудничеству с мировыми поставщиками мы осуществляем комплексные и плановые поставки широчайшего спектра электронных компонентов.

Собственная эффективная логистика и склад в обеспечивает надежную поставку продукции в точно указанные сроки по всей России.

Мы осуществляем техническую поддержку нашим клиентам и предпродажную проверку качества продукции. На все поставляемые продукты мы предоставляем гарантию .

Осуществляем поставки продукции под контролем ВП МО РФ на предприятия военно-промышленного комплекса России , а также работаем в рамках 275 ФЗ с открытием отдельных счетов в уполномоченном банке. Система менеджмента качества компании соответствует требованиям ГОСТ ISO 9001.

Минимальные сроки поставки, гибкие цены, неограниченный ассортимент и индивидуальный подход к клиентам являются основой для выстраивания долгосрочного и эффективного сотрудничества с предприятиями радиоэлектронной промышленности, предприятиями ВПК и научно-исследовательскими институтами России.

С нами вы становитесь еще успешнее!

Наши контакты:

Телефон: +7 812 627 14 35

Электронная почта: sales@st-electron.ru

Адрес: 198099, Санкт-Петербург,
Промышленная ул, дом № 19, литера Н,
помещение 100-Н Офис 331