

HCPL-354

AC Input Phototransistor Optocoupler SMD Mini-Flat Type



Data Sheet



Description

The HCPL-354 contains a phototransistor, optically coupled to two light emitting diodes connected inverse parallel. It can operate directly by AC input current. It is packaged in a 4-pin mini-flat SMD package with a 2.0 mm profile. The small dimension of this product allows significant space saving. The package volume is 30% smaller than that of conventional DIP type. Input-output isolation voltage is 3750V_{rms}. Response time, t_r , is typically 4 μ s and minimum CTR is 20% at input current of ± 1 mA.

Functional Diagram

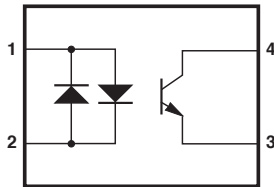

1. ANODE, CATHODE 3. EMITTER
2. CATHODE, ANODE 4. COLLECTOR

Features

- AC input response
- Current transfer ratio (CTR: min. 20% at $I_F = \pm 1$ mA, $V_{CE} = 5$ V)
- Isolation voltage between input and output ($V_{iso} = 3,750$ V_{rms})
- Subminiature type (The volume is smaller than that of conventional DIP type by as far as 30%)
- Mini-flat package
- 2.0 mm profile
- UL approved
- CSA approved
- IEC/EN/DIN EN 60747-5-2 approved
- Options available:
 - IEC/EN/DIN EN 60747-5-2 approvals (060)

Applications

- Detecting or monitoring AC signals
- Programmable controllers
- AC/DC-input modules
- AC line/digital logic isolation

CAUTION: It is advised that normal static precautions be taken in handling and assembly of this component to prevent damage and/or degradation which may be induced by ESD.

Ordering Information

HCPL-354 is UL Recognized with 3750 Vrms for 1 minute per UL1577 and is approved under CSA Component Acceptance Notice #5, File CA 88324.

Part Number	RoHS Compliant Option		Package	Surface Mount	Gull Wing	Tape & Reel	IEC/EN/DIN EN 60747-5-2	Quantity
	Rank '0' 20%<CTR<400%	Rank 'A' 50%<CTR<150%						
HCPL-354	-000E	-00AE	S0-4	X		X		3000 pcs per reel
	-060E	-06AE	S0-4	X		X	X	3000 pcs per reel

To order, choose a part number from the part number column and combine with the desired option from the option column to form an order entry.

Example 1:

HCPL-354-00AE to order product of Miniflat-4 AC Surface Mount package in Tape and Reel packaging with 50%<CTR<150% and RoHS compliant.

Example 2:

HCPL-354-060E to order product of Miniflat-4 AC Surface Mount package in Tape and Reel packaging with 20%<CTR<400%, IEC/EN/DIN EN60747-5-2 Safety Approval and RoHS compliant.

Option datasheets are available. Contact your Avago sales representative or authorized distributor for information.

Package Outline Drawing

HCPL-354-000E

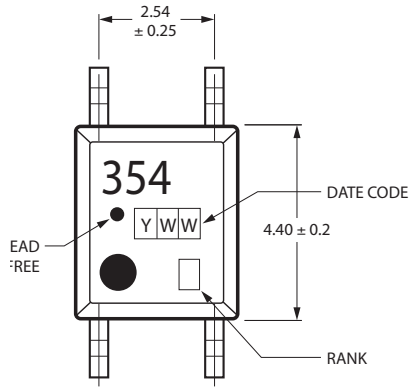

DIMENSIONS IN MILLIMETERS.

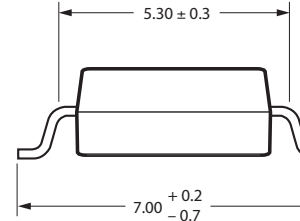
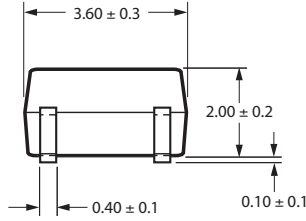

HCPL-354-060E

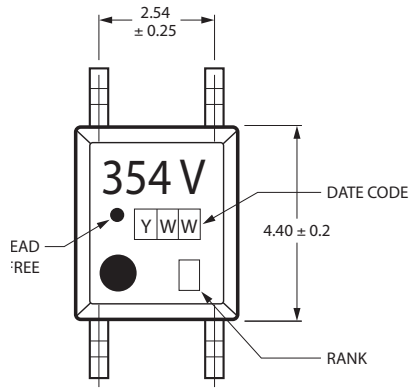

DIMENSIONS IN MILLIMETERS.

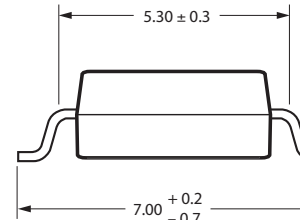
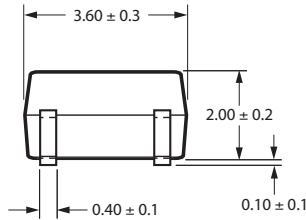

Solder Reflow Temperature Profile

- 1) One-time soldering reflow is recommended within the condition of temperature and time profile shown at right.
- 2) When using another soldering method such as infrared ray lamp, the temperature may rise partially in the mold of the device. Keep the temperature on the package of the device within the condition of (1) above.

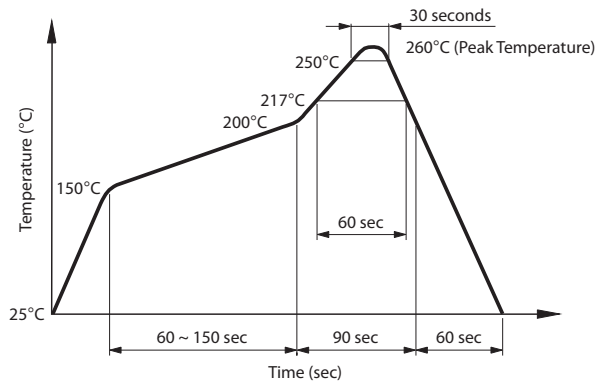

Note: Non-halide flux should be used.

Absolute Maximum Ratings

Parameters	Symbol	Min.	Max.	Units
Storage Temperature	T_S	-55	150	°C
Ambient Operating Temperature	T_A	-55	100	°C
Lead Solder Temperature for 10s (1.6 mm below seating plane)	T_{sol}		260	°C
Average Forward Current	I_F		±50	mA
Input Power Dissipation	P_I		70	mW
Collector Current	I_C		50	mA
Collector-Emitter Voltage	V_{CE0}		35	V
Emitter-Collector Voltage	V_{ECO}		6	V
Collector Power Dissipation	P_C		150	mW
Total Power Dissipation	P_{tot}		170	mW
Isolation Voltage (AC for 1 minute, R.H. = 40 ~ 60%) ^[1]	V_{iso}		3750	V_{rms}

Electrical Specifications ($T_A = 25^\circ\text{C}$)

Parameter	Symbol	Min.	Typ.	Max.	Units	Test Conditions
Forward Voltage	V_F	–	1.2	1.4	V	$I_F = \pm 20\text{ mA}$
Terminal Capacitance	C_t	–	30	250	pF	$V = 0, f = 1\text{ kHz}$
Collector Dark Current	I_{CE0}	–	–	100	nA	$V_{CE} = 20\text{ V}, I_F = 0$
Collector-Emitter Breakdown Voltage	BV_{CE0}	35	–	–	V	$I_C = 0.1\text{ mA}, I_F = 0$
Emitter-Collector Breakdown Voltage	BV_{ECO}	6	–	–	V	$I_E = 10\text{ }\mu\text{A}, I_F = 0$
Collector Current	I_C	0.2	–	4	mA	$I_F = \pm 1\text{ mA},$
Current Transfer Ratio ^[2]	CTR	20	–	400	%	$V_{CE} = 5\text{ V}$
Collector-Emitter Saturation Voltage	$V_{CE(sat)}$	–	0.1	0.2	V	$I_F = \pm 20\text{ mA}, I_C = 1\text{ mA}$
Isolation Resistance	R_{iso}	5×10^{10}	1×10^{11}	–	Ω	DC 500 V 40 ~ 60% R.H.
Floating Capacitance	C_f	–	0.6	1	pF	$V = 0, f = 1\text{ MHz}$
Response Time (Rise)	t_r	–	4	18	μs	$V_{CE} = 2\text{ V}, I_C = 2\text{ mA},$
Response Time (Fall)	t_f	–	3	18	μs	$R_L = 100\text{ }\Omega$

Rank Mark	CTR (%)	Conditions
A	50 ~ 150	$I_F = \pm 1\text{ mA},$
No Mark	20 ~ 400	$V_{CE} = 5\text{ V},$ $T_A = 25^\circ\text{C}$

Notes:

- Isolation voltage shall be measured using the following method:
 - Short between anode and cathode on the primary side and between collector and emitter on the secondary side.
 - The isolation voltage tester with zero-cross circuit shall be used.
 - The waveform of applied voltage shall be a sine wave.

$$2. \text{ CTR} = \frac{I_C}{I_F} \times 100\%$$

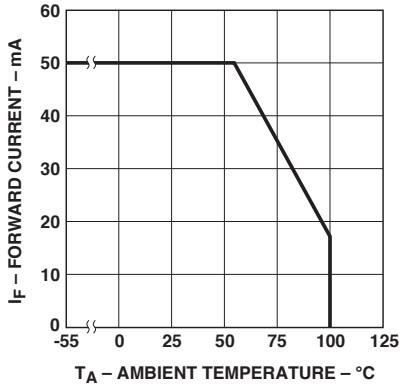

Figure 1. Forward current vs. ambient temperature.

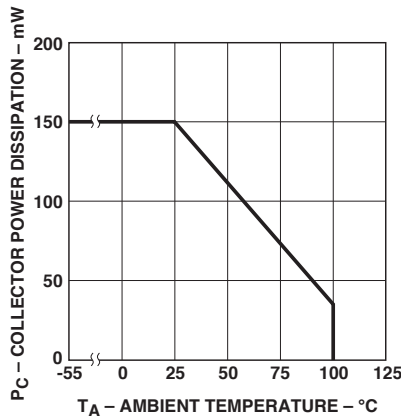

Figure 2. Collector power dissipation vs. ambient temperature.

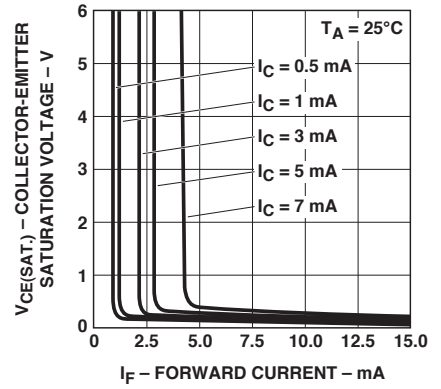

Figure 3. Collector-emitter saturation voltage vs. forward current.

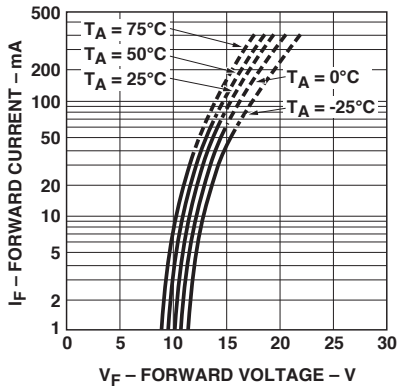

Figure 4. Forward current vs. forward voltage.

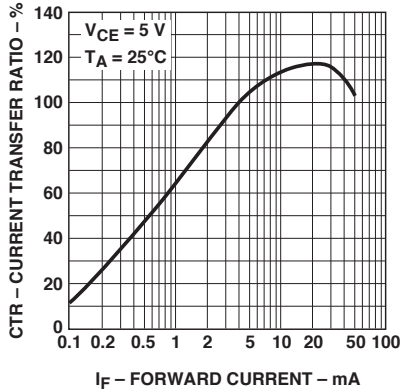

Figure 5. Current transfer ratio vs. forward current.

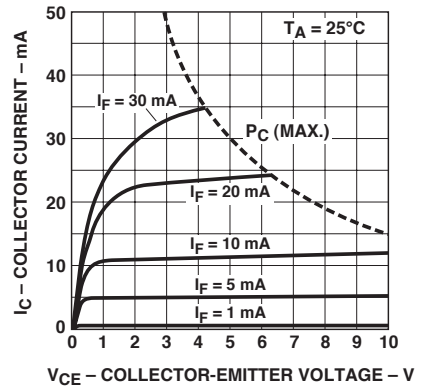

Figure 6. Collector current vs. collector-emitter voltage.

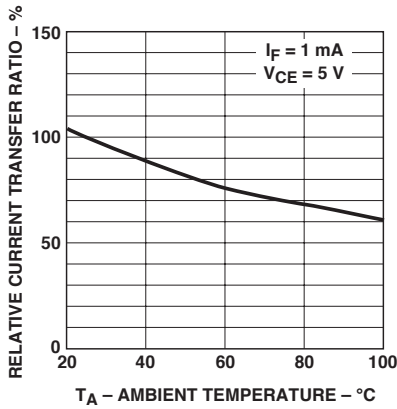

Figure 7. Relative current transfer ratio vs. ambient temperature.

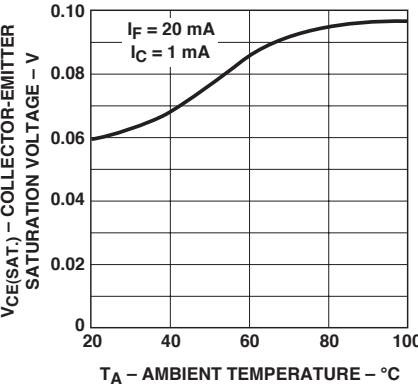

Figure 8. Collector-emitter saturation voltage vs. ambient temperature.

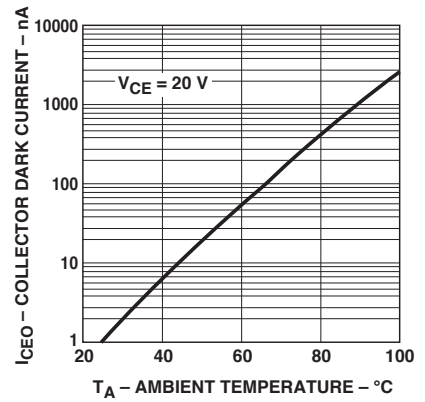

Figure 9. Collector dark current vs. ambient temperature.

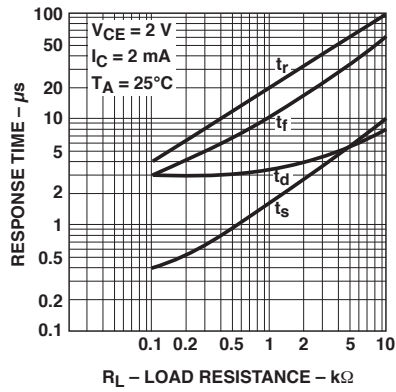

Figure 10. Response time vs. load resistance.

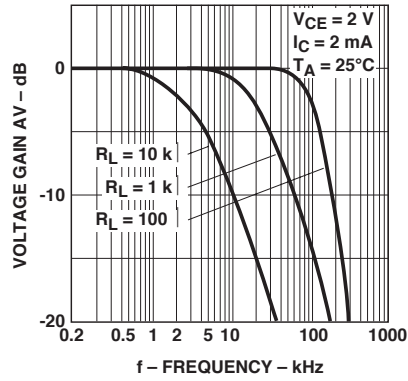

Figure 11. Frequency response.

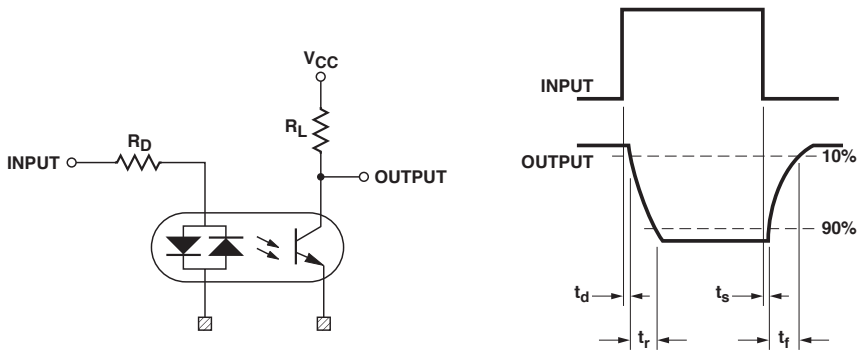

Figure 12. Test circuit for response time.

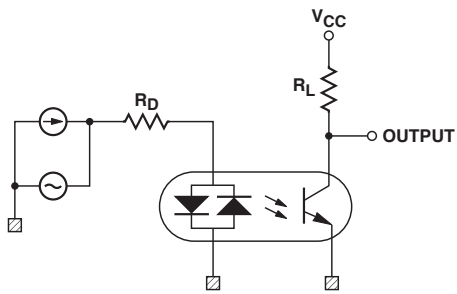

Figure 13. Test circuit for frequency response.

For product information and a complete list of distributors, please go to our web site: www.avagotech.com

Avago, Avago Technologies, and the A logo are trademarks of Avago Technologies, Limited in the United States and other countries. Data subject to change. Copyright © 2007 Avago Technologies Limited. All rights reserved. AV02-0775EN - October 18, 2007





Стандарт Электрон Связь

Мы молодая и активно развивающаяся компания в области поставок электронных компонентов. Мы поставляем электронные компоненты отечественного и импортного производства напрямую от производителей и с крупнейших складов мира.

Благодаря сотрудничеству с мировыми поставщиками мы осуществляем комплексные и плановые поставки широчайшего спектра электронных компонентов.

Собственная эффективная логистика и склад в обеспечивает надежную поставку продукции в точно указанные сроки по всей России.

Мы осуществляем техническую поддержку нашим клиентам и предпродажную проверку качества продукции. На все поставляемые продукты мы предоставляем гарантию .

Осуществляем поставки продукции под контролем ВП МО РФ на предприятия военно-промышленного комплекса России , а также работаем в рамках 275 ФЗ с открытием отдельных счетов в уполномоченном банке. Система менеджмента качества компании соответствует требованиям ГОСТ ISO 9001.

Минимальные сроки поставки, гибкие цены, неограниченный ассортимент и индивидуальный подход к клиентам являются основой для выстраивания долгосрочного и эффективного сотрудничества с предприятиями радиоэлектронной промышленности, предприятиями ВПК и научно-исследовательскими институтами России.

С нами вы становитесь еще успешнее!

Наши контакты:

Телефон: +7 812 627 14 35

Электронная почта: sales@st-electron.ru

Адрес: 198099, Санкт-Петербург,
Промышленная ул, дом № 19, литера Н,
помещение 100-Н Офис 331